

Vertical transparent door cooler

Operation manual

Haier

SC-210GA/240GA/300GA/340GA

HVC-220G/340G

0070508667

Haier

Content

Before Operation

Features of the product-----1
Name of the product parts-----2
Notice for Safety -----3
Ambient environment-----4

Startup and Operation

Preparation before operation-----5
Startup,operation and temperature adjustment-----6
Lamp and illumination description-----7
Food storage instructions-----8

Maintenance and Service

Clean•Stop operation•Questions-----9
After-sale service-----10

- Please carefully read this instruction book before using.
- Please take care to hold.
- This cooler is for commercial use, and in accordance with the stipulations of national standard, it could only be used for storing food, and could not be used for other purposes including storing live things, flower, medicine, vaccine, chemical reagent, blood products and biological products.

Features of the product

- This product is a commercial-use cooler with an elegant design & appearance, fast refrigeration, is fit to be used in shopping mall, super market, hotel and cold drink shop.

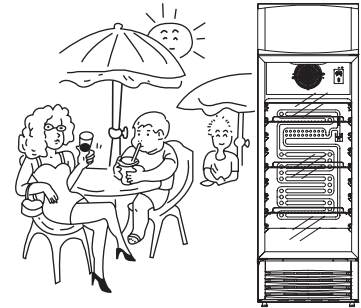

- With the introduction of hollow reinforced glass, the door has high transparency and good heat insulation, and the stored food is very clear with one look.

- Top light canopy with strong advertisement and brand displaying effect.

- Air-cooling with fast cooling speed and evenly inner temperature.

- The food rack can be freely adjusted according to size of the stored food

- Lock nose is provided in the left bottom part of the door, which can be used with the lock so as to ensure the security of the stored food.

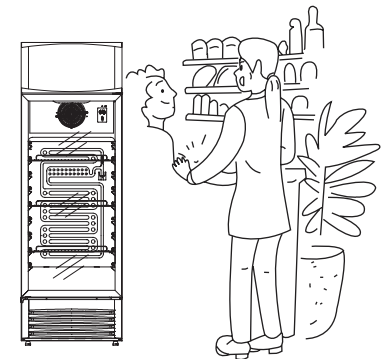

Name of the product parts

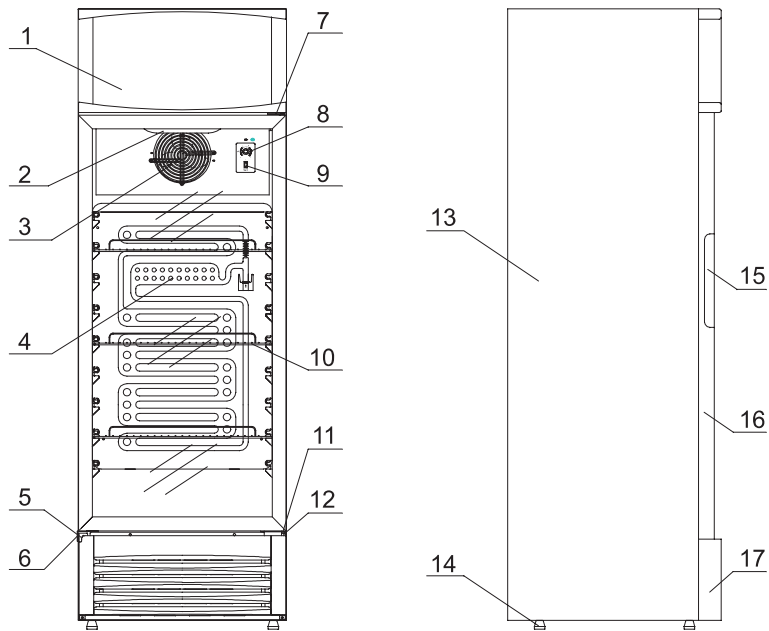

(Model SC-300GA)

- | | | |
|----------------|-----------------------------|----------------|
| 1-Light canopy | 2-Inner light | 3-Fan shield |
| 4-Evaporator | 5-Door support | 6-Lock nose |
| 7-Upper hinge | 8-Thermostat | 9-Light switch |
| 10-Shelves | 11-Door stopper | 12-Lower hinge |
| 13-Cabinet | 14-Adjustable feet (Castor) | 15-Handle |
| 16-Glass door | 17-Front shield | |

The Haier cooler bought by the customer may differ from the actual unit to the illustration provided because of the development of the product and serialization.

After-sale service

Any product may malfunction, please observe the operation of beverage cooler and change of stored beverages when the unit is in operation, in any case there is an abnormal event, please check and refer to the following table accordingly

The cooler doesn't work



Please check electric circuit

- Check the condition of safety fuse
- Whether the contact between plug and socket is not good.
- Any malfunction in input, control circuit
- Voltage is too low
- Whether the temperature controller is not in the working position
- Whether the refrigeration switch is open



Weak cooling effect

- Whether the stored food is too much or there is hot food
- Is there any space between the food/beverages
- Is the cooler located at direct sunlight or near to any other heat source radiation
- Has the door been opened too frequently or the door not closed completely

Noise is too loud

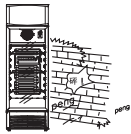

- Is the place of the cooler not level
- Do some parts of the unit contact with outside materials or wall

There is a through-hole pin in the data bag. When the cooler is put into first operation, the through-hole pin should be put inside the water outlet. When the cooler is in operation, the water outlet should be ensured to be smooth, thus the water could flow to the drain pan inside the engine chamber of the cooler through water outlet. When clogged, the through-hole pin could be taken out and put back after cleaning. Note: through-hole pin could not be used as tool to clean the water outlet. This could be placed inside the water outlet to avoid clogging.

Water outlet

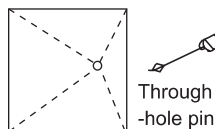

Notice for Safety

It uses AC 220-240V/50Hz; 220V/60Hz power. When the power fluctuation range is big. It may cause the following, cooler unable to startup, temperature controller and compressor damage or abnormal noise arise when compressor in operation. An automatic voltage regulator with 1000W power rating should be equipped for operation.



Special socket should be used and has reliable earthing. When the cooler is placed, the plug should be easily reached

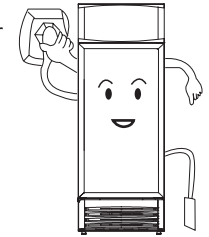

Inflammable substance, explosive substance, strong corrosive salt, alkali and medicine or biological products which have strict requirement on temperature are not allowed inside the cooler

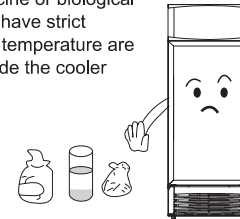

The inflammable nebula should not be used to close to the cooler so as to avoid fire accident.

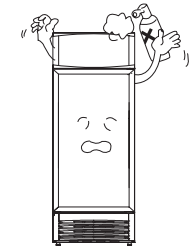

When coal gas or inflammable gas is leaking:

- Close the leaking valve
- Open the door and window and let those air out of the room
- Do not pull the power plug or insert the power plug of the cooler.

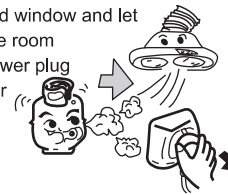

Do not allow child to play inside the cabinet to avoid the accident



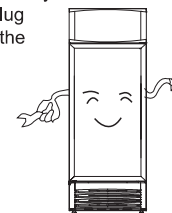

Once the cooler is power off, it should be switched on after waiting for at least 5 minutes to avoid damage to the compressor or system. When in maintenance, the power plug should be pulled out from the power outlet



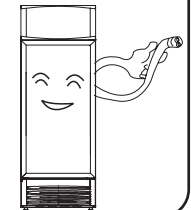

If power supply cord need to be extended, the additional line cross section area should be no less than 0.75mm². If the power cord is damaged, it should be replaced by our authorized service center.

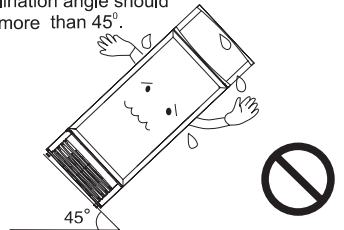
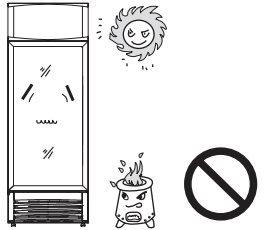
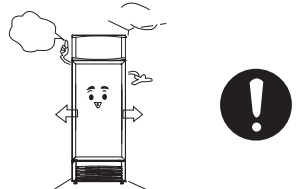
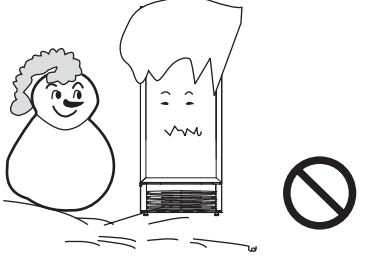

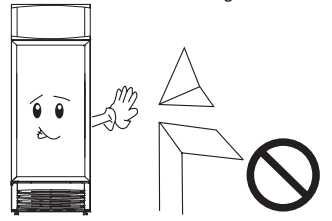
Ambient Environment

| | |
|--|--|
| <p>The cooler should be placed horizontal and stable, and should be removed from package seat so as to reduce vibration and noise. When being moved, the inclination angle should be no more than 45°.</p>  | <p>The cooler should not be placed under direct sunlight and keep away from hot sources, ambient temperature not more than 43°C.</p>  |
| <p>In order for the cooler to have a good effect of cooling, this should be located in a room, with good air ventilation. A distance of 10cm between the wall and cooler air is required.</p>  | <p>It should not be placed in an environment where it is too cold to freeze. Not for temperate climate.</p>  |
| <p>It should not be placed in moist place or where water is easily splashed, and the splashed water or dirt should be cleaned by using soft cloth. It should not be used in open air so as to avoid rain.</p>  | <p>There should be no acute corner angle around the cooler so as to avoid contact to the glass</p>  |

Description of Sign meaning

| | |
|---|--|
|  | <p>The content with "warning" sign is in association with product safety and user's personal safety; operation should be strictly in accordance with the warning material.</p> |
|  | <p>The content with "forbid" sign is operation that should be absolutely forbidden, otherwise it may cause damage to cooler or damage to user's personal safety.</p> |

Clean•Stop Operation•Troubleshooting

Clean and maintenance

For safety, please disconnect the cooler from power supply before cleaning

When cleaning the cooler, please use soft cloth or sponge, dip water or soap (no corrosiveness neutral cleaning agent is ok). Use dry cloth to wipe off the water after cleaning so as to avoid rust.

In cleaning, cooler should not be flushed with water or being cleaned by using hard hair brush or steel brush.)

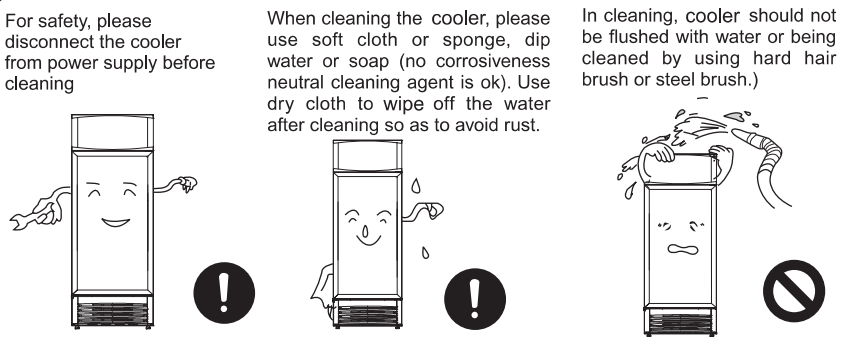

STOP OPERATION

Please don't use materials like organic solvent, boiled water, washing powder or acid to clean the cooler.

If the cooler will not be used for a long time, it should be disconnected from power supply and be cleaned according to above mentioned method, and door opened, air dry the inner part of the cabinet before being sealed for storage.

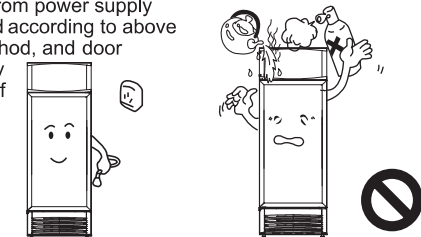







Trouble-shooting:

The following observations are normal in use



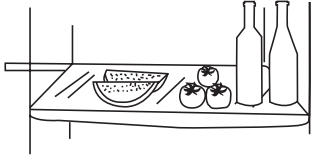
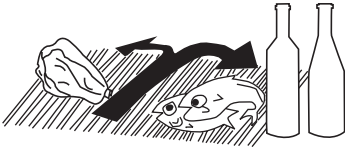

| Event | Cause and solution |
|--|---|
| Liquid fluid sound from the cooler | The sound is coming from the flow of the refrigerant in the tubes, which is normal |
| Refrigerant system hasn't been in operation for a long time while the cabinet temperature of the cooler is still low | Cooler has good temperature protection with low loss of cold over and the ambient temperature is a little low and that is normal |
| Condensed water on glass door | The environment is too moist or humid while temperature control inside the cabinet setting is too low, use towel to wipe off the condensed water. |

- The design and production of this conform with corresponding standards of our country. Should there be any problem, please first check if it is caused by abnormal operation.
- Please get rid of the seal before you throw away the cooler so that the child will not play with it and thus causes accident.

Food Storage Instruction

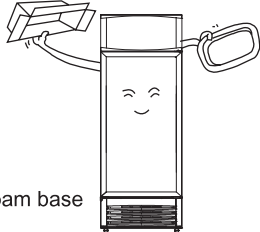
| | |
|--|---|
| <p>Clean and wipe off water from the foods before putting in the cooler for storage.</p>  | <p>Do not store live things, medicine and flower which with strict requirements on temperature</p>  |
| <p>When storage, the food should keep a distance of 1-3 cm away from the back of chamber for the good circulation of cold air.</p>  | <p>Put space between foods for better circulation of air.</p>  |
| <p>The food should be sealed before putting into the cooler so as to prevent the dissipation of moisture and mixing taste.</p>  | <p>When packing foods, use packing material for cooling storage, the material should be asepsis, taste free, gas proof and water-proof.</p>  |
| <p>The food should be placed in classifications, especially for retailed cooked food including meat and fish should not be stored for long time.</p>  | <p>When storing food, should observe the storage period noted by the production plant. (The stored date can be noted in the packing bag to avoid exceed the time limit.</p>  |

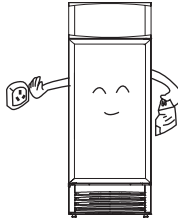
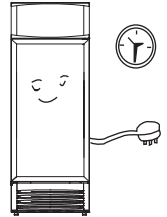
Preparations before operation

| | |
|---|---|
| <p>1 Unpack all packing material</p>  <p>Including foam base</p> | <p>2 Adjustment of foot</p> <p>Adjust the foot to make the cooler horizontal so as to reduce vibration and noise.</p>  |
| <p>3 Clean the cooler before using</p>  | <p>4 Standing</p> <p>After being moved, the cooler should be standing for at least 30 minutes before power on</p>  |
| <p>5 Power on</p> <p>After power on, make a trial operation for half an hour, if obvious drop of temperature can be felt, the cooler operation is normal.</p>  | |

Startup, operation and temperature adjustment

Startup and operation

After the cooler being unpacked and placed on the right position, the cooler should be in operation for half an hour before putting into food for cold storage

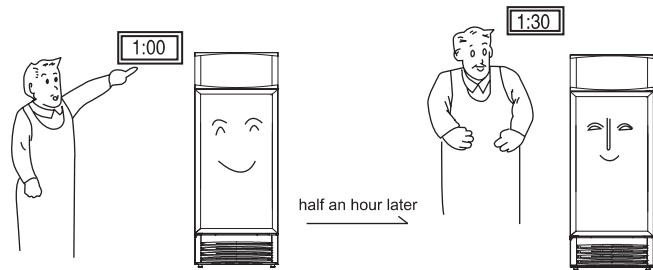

Temperature adjustment and refrigeration switch operation instruction

● The storage temperature is adjusted by thermostat which is installed on the fan motor board in the back of cooler. The inside temperature reduce gradually if you take the thermostat position from " 0 " to " 6 " , which depends on the environment and kind of storage. position " 6 " is the lowest temperature position, " 0 " is turning off point, and cooler stops operation. Factory set will be " 3 " .

● Temperature controller regulation guide: In summer, ambient temperature is a little high, temperature controller knob should be rotated in counter clockwise direction, and the step should be changed to "2"; in cold weathers, ambient temperature is a little low, temperature controller knob should be rotated in clockwise direction, and the step should be changed to "3-4"; before leaving the plant, the temperature controller knob is regulated to 3. Before putting into operation, the cooler's temperature controller knob should be checked for suited position and should not be frequently adjusted.

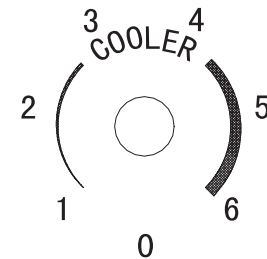

Light switch

Lamp and illumination description

Lamp and illumination description

- This product has top display light canopy and inner light. (Some cabinets of this series have not lamp in canopy.) The canopy and inner light is controlled by the same light switch which is on the fan motor board in the back of cooler. The canopy light can highlight your advertisement logo on the top. Power rate of all the light is 9w.
- Replacement of inside light:
 - Power off and remove the screw of lampshade, take off the shade.
 - Screw off the light and replace a new one.
 - Install the new light with the opposite process.
- Replacement of the canopy light (Suitable for the cabinet which has the lamp in canopy.)
 - Power off and remove the screw of canopy connection strip, pull out the canopy plate.
 - Screw off the fluorescent light and replace a new one.
 - Install the new light with the opposite process.

Please note that the replacement of light must be operated by the professional staff.

Free Manuals Download Website

<http://myh66.com>

<http://usermanuals.us>

<http://www.somanuals.com>

<http://www.4manuals.cc>

<http://www.manual-lib.com>

<http://www.404manual.com>

<http://www.luxmanual.com>

<http://aubethermostatmanual.com>

Golf course search by state

<http://golfingnear.com>

Email search by domain

<http://emailbydomain.com>

Auto manuals search

<http://auto.somanuals.com>

TV manuals search

<http://tv.somanuals.com>