

# USER MANUAL

# Palsonic

- 5115DVD
- 51cm TV / DVD Combination

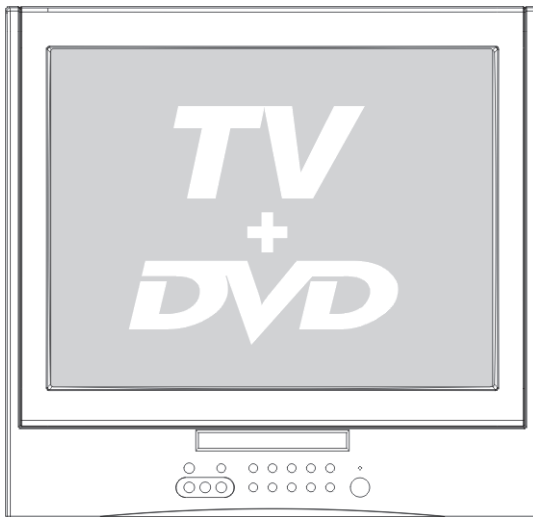

Please read this manual carefully  
before using this TV set and keep it  
for future reference.

# CONTENTS

## Before Operation

<b>Warning and cautions</b> .....	1
<b>Installation</b> .....	2
Aerial connection.....	2
Preparation of the remote control.....	2
<b>Function buttons and external sockets</b> .....	3
Front panel of the TV set.....	3
Rear panel of the TV set.....	3
<b>Using the remote control</b> .....	4

## Basic operation

<b>Switching the TV set on/off</b> .....	5
<b>Watching TV</b> .....	6
Watching TV program.....	6
Program swap and auto scan functions.....	7
<b>Searching channel</b> .....	8
Full automatic mode.....	8
Semi-automatic search.....	9
Manual fine tune.....	10
Program skip .....	11
<b>Convenient picture and sound control functions</b> .....	12
Multiple picture modes .....	12
Black stretch and noise reduce.....	13
Mute and Fade .....	14
<b>Time functions</b> .....	15
Clock setting and timer on/off functions.....	15
Sleep timer and program preset .....	16
<b>Setup function</b> .....	17
Screen saver and Calendar.....	17
AVL .....	18
<b>Organise function</b> .....	19
<b>Setting the lock</b> .....	20

## DVD Operation

<b>Basic Playback</b> .....	22
<b>Advanced Playback</b> .....	23
<b>Special Function</b> .....	24
<b>DVD System Setup</b> .....	25
<b>Playable Discs</b> .....	29
<b>Disc Protection and DVD Characteristics</b> .....	30

## Others

<b>Connection to the external audio and video equipment</b> .....	31
<b>Troubleshooting guide</b> .....	32
<b>Specifications</b> .....	33

## Warning and cautions

1. When you clean the TV set, please pull out the power plug from AC outlet. Don't clean the cabinet and the screen with petrol, paraffin or other powerful solvents. Permanent damage will result!



4. Do not place the TV set near rain or moisture as it may cause an electric shock, or the TV set to catch fire. The TV set must only be used in dry in door locations.

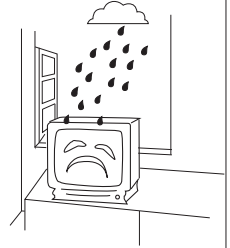

2. In order to prolong the life of the product, please use in a well ventilated location. Leave a 10cm gap around it. Do not obstruct air flow with soft furnishings above or beneath.

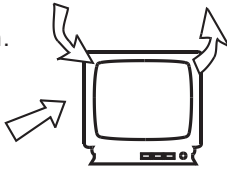

5. The back cover must only be removed by a registered electrical service person. Removing the back cover may result in electric shock, fire or damage to the TV set.

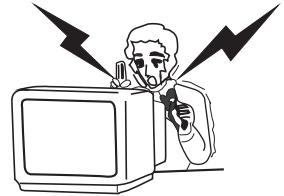

3. Don't place the TV set in direct sunlight or near a heat source.

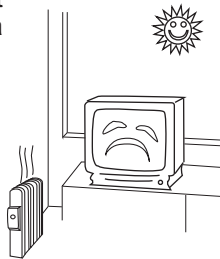

6. If the TV set is not going to be used for a long time, or there is a severe thunder & Lighting storm, we recommended that the TV set be disconnected you disconnect the TV set from the AC power outlet and remove the aerial plug.



## Cleaning the tube

If the picture tube require cleaning, disconnect the power and use a dry soft cotton cloth. Do not use any cleaner or abrasive cloths.

# Installation

## Aerial Connection

If the picture is not clear or snowy, we recommend that you use an outdoor aerial. In different places, the suitable antenna type and position are different.

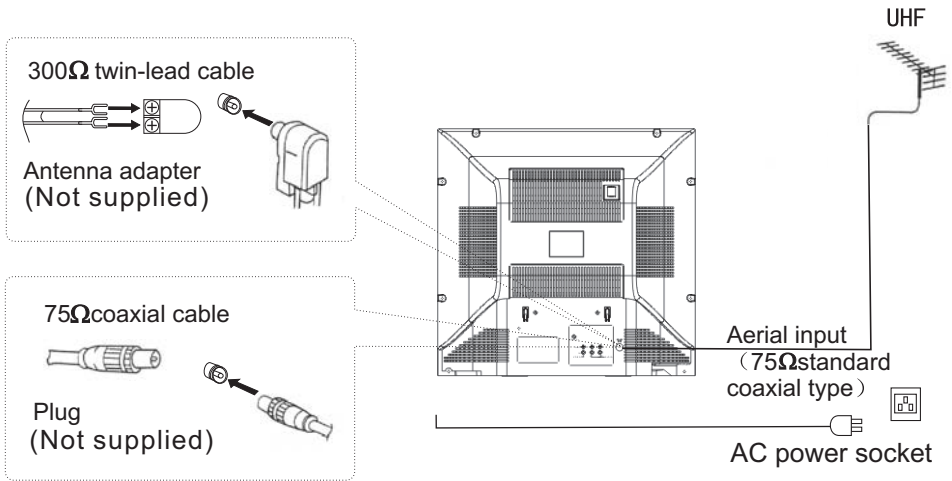

### Note:

- \* It is recommended that a 75 ohm coaxial antenna is used to avoid interference.
- \* To avoid interference from electrical signals, do not bind the antenna cable together with any mains lead.

## Preparation for the remote control

### Battery installation

Remove the battery cover.

Insert two size AA batteries matching the +/- polarities of the battery to the +/- marks inside the battery compartment.

### Tips for remote operation

When the remote control will not be used for a long period of time or when the batteries are worn out, remove the batteries to prevent leakage.

Do not throw the batteries into fire. Dispose of used batteries at your local recycling centre.

Do not drop, dampen or disassemble the remote control.

# Function Buttons and External Sockets

## Front panel the TV set

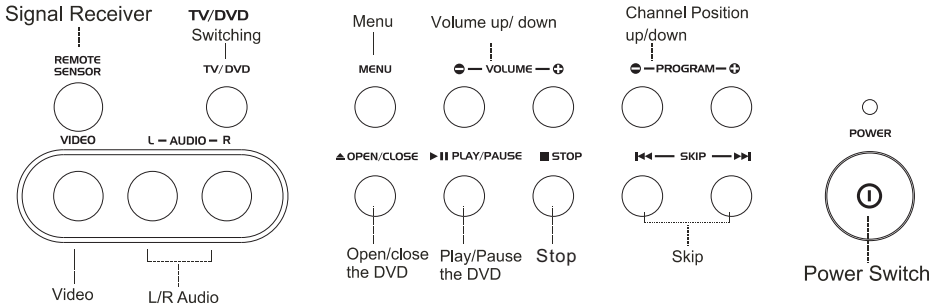

## Rear panel of the TV set

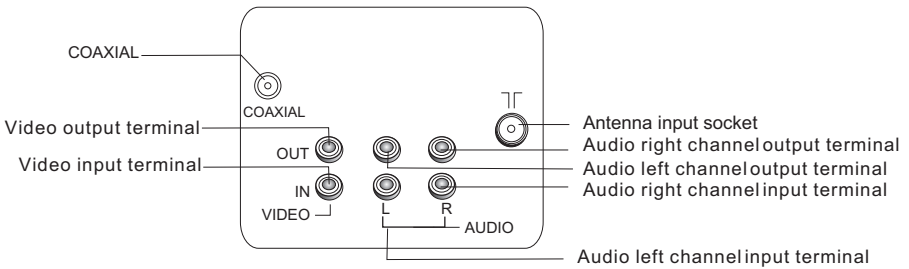

# Using the Remote Control

## Buttons on the remote control

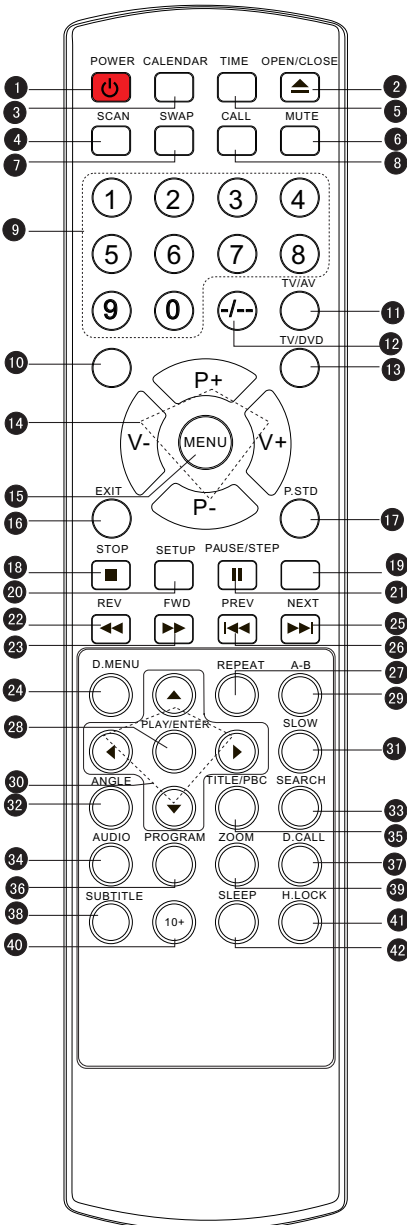

- 1 Stand By
- 2 DVD Open/close
- 3 Calendar
- 4 Scan
- 5 TV Time Menu
- 6 Mute
- 7 Former Program
- 8 Call Screen Display
- 9 Program Number
- 10 (Not available)
- 11 TV/AV Exchange
- 12 Digital Selector
- 13 TV/DVD
- 14 Volume/Channel Selection
- 15 MENU
- 16 Exit Screen Display
- 17 Picture Mode
- 18 DVD STOP
- 19 (Not available)
- 20 DVD SETUP
- 21 DVD PAUSE/STEP
- 22 DVD FAST REVERSE
- 23 DVD FAST FORWARD
- 24 DVD MENU
- 25 DVD NEXT
- 26 DVD PREVIOUS
- 27 DVD REPEAT
- 28 DVD PLAY/ENTER
- 29 DVD A-B REPEAT
- 30 DVD Cursor Move button
- 31 DVD SLOW
- 32 DVD ANGLE
- 33 DVD SEARCH
- 34 DVD Audio
- 35 DVD TITLE
- 36 DVD PROGRAM
- 37 DVD CALL
- 38 DVD SUBTITLE
- 39 Zoom
- 40 DVD 10+
- 41 Child Lock
- 42 TV Sleep button

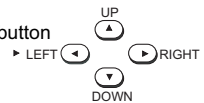

## Switching on/ off the TV set

- This section explains the use of the power button and remote handset to turn your unit on and off.

### Switching the TV set on/ off

#### Switching the TV set on/ off

1 Press the AC power switch on the front of the TV. The power indicator will light.

2 If the indicator is lighting in red, press the button  on the remote control again.

Note:

1 When you can't operate the TV set with a remote control, you can turn it on by pressing the P+/- buttons on the TV set (Child Lock must be turned off).

4  
AUTO  
BG

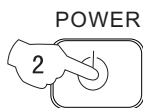

2 If you want to change to standby mode, press down the button  on the remote control. Press again to switch back on.

3 If you want to fully switch off the power supply for the TV set, please press the power switch button on the front panel.

#### Auto switch off function

If transmissions are finished for the day, the Automatic Power Off feature will put the TV to standby automatically. The Automatic Power Off feature will not operate in AV mode or when the background is set to off (see page 19).

# Watching TV

- You can watch a TV program on a channel which has been tuned to a broadcast.

## Watching TV programs

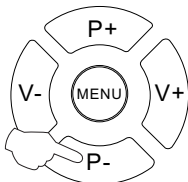
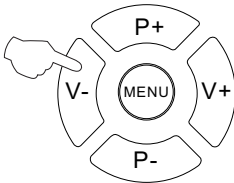
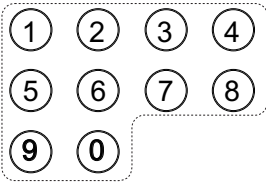

### How to select TV program

#### Select the desired program

##### 1 Using number buttons

- Directly enter the channel number with the numeric keypad on the remote control.
- To select channel numbers between 10 ~ 99 press [-/--] button and enter the two digit channel number
- To select channel numbers between 100 ~ 218 press [-/--] button twice and enter the 3 digit channel number

##### 2 Using the P+/- buttons

- Press the P+ button to increase channel number.
- Press the P- button to decrease channel number.

#### Select the desired sound

Press the V-/+ buttons on the remote or the front of the TV set to adjust the volume level. The range is 0~100. When the volume buttons are pressed the volume level is displayed automatically on the TV screen.

#### How to select the menu

Press the MENU button and the menus will appear at the bottom of the screen. The PIC icon will initially be flashing. Each subsequent press of the menu button will highlight SOU (sound), FUN (function), TUN (tuning) icons respectively. Press the P- button to display the appropriate menu. Press EXIT to exit.

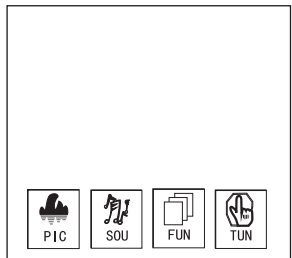



## Watching TV (continued)

- Press the SWAP button to select the channel you were watching previously.
- Auto scan function scans through all programs in memory including those with "skip" set to "off" (see "Program skip" on page 13).

### Program swap and auto scan functions

#### Program swap

Press the SWAP button to select the channel you were watching previously.

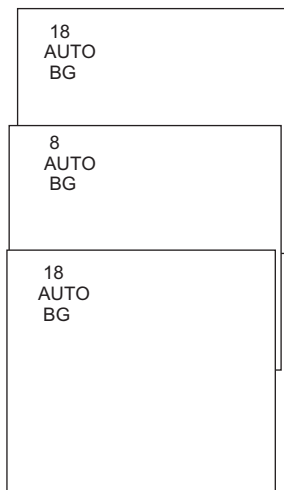
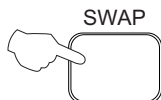

#### Auto program scan

1 Press the SCAN button to scan through all the memorised TV programs. The scan will pause for about 2 seconds on each channel.

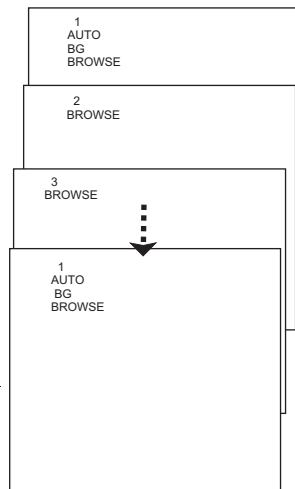

2 If you want to stop the function during auto tuning, simply press the SCAN button again.







# Searching channel

(Continued)

## Program skip

### Program skip

Channels can be set so that they are skipped during program selection.

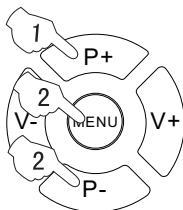

1 Press the P+/- buttons or PROGRAM NUMBER (0-9) button to choose the desired channel (e.g. channel 1).

1  
AUTO  
BG

2 Press the **MENU** button. The *MAIN MENU* will appear with the *PIC* (picture) icon flashing. Press the **MENU** button a further 3 times until the *TUN* (tuning) icon is flashing. Press **P-** to enter the *TUNING* menu.

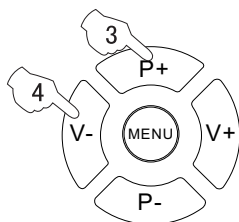

3 Press the P+/- buttons to select "SKIP".



4 Press the V-/+ buttons to turn the SKIP function "ON".

SKIP  
PROG NO  
ORGANISE  
SEARCH  
FINE TUNE  
▲ ▼

OFF

5 Press the EXIT button to close the menu. When you use the P+/- buttons to select channel, this channel will be skipped. However, you can still use the PROGRAM NUMBER buttons to select the skipped channel numbers.

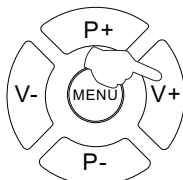

### If you want to recover the skipped channel

- 1 Use the PROGRAM NUMBER buttons to select the channel number to be recovered.
- 2 Repeat steps 1-3 above.
- 3 Press the V-/+ buttons to turn the SKIP function "OFF".

# Convenient picture and sound control functions

## Multiple picture modes



### How to select picture modes

You can quickly select the desired picture mode from four preset modes and one customized mode. Press the P.STD button to select the desired picture quality. Five kinds of picture modes (i.e., "STANDARD", "RICH", "USER", "LISTEN", "SOFT" ) can be selected in turn.

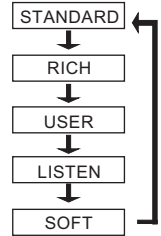

The 5 modes are

- Listen-This is a new feature that blacks out the TV screen when listening to music only channels;
- Soft-Designed for night time low light viewing;
- Standard -Designed for rooms that have good all round lighting;
- Rich-Designed for rooms with high ambient lighting such as daytime sport;
- User-A spare setting that can be adjusted to personal tastes.

### How to customize your own picture status

1 Press the **MENU** button. The *MAIN MENU* will appear with the *PIC* (picture) icon flashing. Press **P-** to enter the *PICTURE* menu.

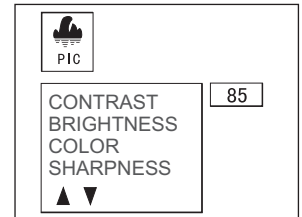
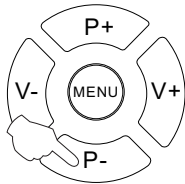

2 Press the P+/- buttons to select the item to adjusted, then press the V-/+ buttons to obtain the desired effect.

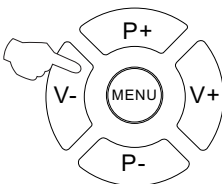

ITEM	Press V-	Press V+
CONTRAST	Weak	Strong
BRIGHTNESS	Dark	Bright
COLOUR	Shallow	Deep
SHARPNESS	Soft	Sharp
*Hue	lean to purple	lean to green

Note:The "Hue" item only appears when the colour system is NTSC.

## Convenient picture and sound control functions

(Continued)

- Black Stretch Automatically increases the contrast range
- Noise Reduce Picture Noise & Grain Reduction Circuit. (Use only on poor reception)

### Black stretch and noise reduce

#### How to select BLACK STRETCH

1 Press the **MENU** button. The *MAIN MENU* will appear with the *PIC* (picture) icon flashing. Press the **MENU** button a further 2 times until the *FUN* (function) icon is flashing. Press **P-** to enter the *FUNCTION* menu.

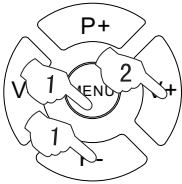
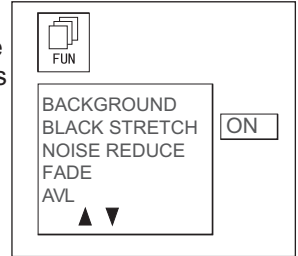

2 Press the **P+/-** button to select "BLACK STRETCH". Press the **V-/+** buttons to turn it "ON" or "OFF".

#### How to select NOISE REDUCE

1 Press the **MENU** button. The *MAIN MENU* will appear with the *PIC* (picture) icon flashing. Press the **MENU** button a further 2 times until the *FUN* (function) icon is flashing. Press **P-** to enter the *FUNCTION* menu.

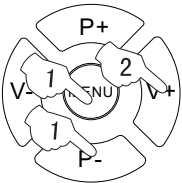
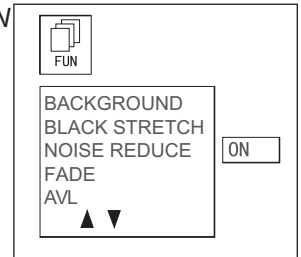

2 Press the **P+/-** buttons to select "NOISE REDUCE". Press the **V-/+** buttons to turn it "ON" or "OFF".

# Convenient picture and sound control functions

(Continued)

## Mute and Fade

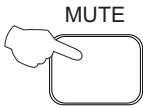

### Sound mute

1 Press the MUTE button on the remote control to turn off the sound. MUTE will appear on the top left of the display.



2 Press MUTE again to turn the sound back on.

### Fade

When FADE is turned on, the TV will protect the tube by fading the picture in when the TV is switched on, and fading the picture out when the TV is switched off.

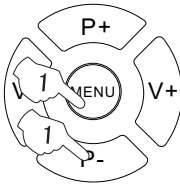

1 Press the **MENU** button. The *MAIN MENU* will appear with the *PIC* (picture) icon flashing. Press the **MENU** button a further 2 times until the *FUN* (function) icon is flashing. Press **P-** to enter the *FUNCTION* menu.

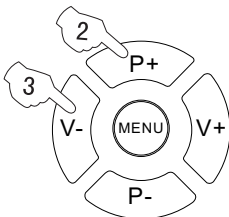
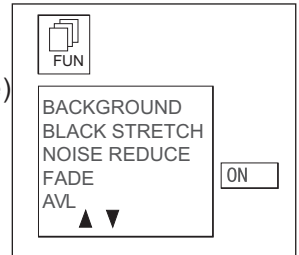

2 Press the P+/- buttons to select FADE.

3 Press the V-/+ button to turn the FADE function "ON" or "OFF".



## Clock setting and timer on/off functions

### Clock setting

The clock will only work if the TV set is left turned on or in standby. When the set is disconnected from the power supply or is turned off by the main power on the front panel, the clock loses power and will need to be reset when the power is reconnected.

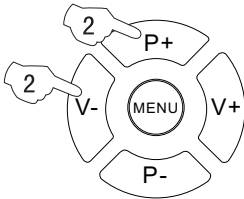
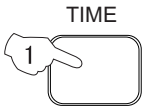

1 Press the TIME button, and the TIME menu appears on the screen.

2 Press the P+/- buttons select "CLOCK", then press the V -/+ buttons to adjust the time in hour position; press again the P+/- buttons to select the time in minute position, then press the V- /+ buttons to adjust the value of minutes .

TIME	
CLOCK	17:18
ON TIME	18:00
ON PROG	1
OFF TIME	--:--
SLEEP TIME	0
REMIN TIME	--:--
REMIN PROG	1

### On/off timer On-off time setting is cleared after timer operates.

Using on/off timer function, the TV set can automatically turn on to a preset program or shut down at a preset time.

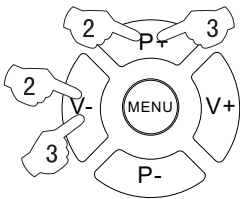
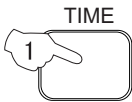

1 Press the TIME button, and the TIME menu display on the screen.

2 Press the P+/- buttons to select "ON TIME", then press the V-/+ buttons to set the value in hour position; press again the P+/- buttons to select the minute position and set the value of the minute (take 18:00 as an example).

TIME	
CLOCK	17:18
ON TIME	18:00
ON PROG	1
OFF TIME	--:--
SLEEP TIME	0
REMIN TIME	--:--
REMIN PROG	1

3 Press the P+/- buttons to select "ON PROG", then press the V-/+ or program number buttons to select your desired channel (take 8 as an example).

TIME	
CLOCK	17:18
ON TIME	18:00
ON PROG	8
OFF TIME	23:00
SLEEP TIME	0
REMIN TIME	--:--
REMIN PROG	1

4 Repeat step 1-2 to set OFF TIME (take 23:00 as an example).

# Time functions

(Continued)

## Sleep timer and program preset

### Sleep timer

The sleep timer switches the set to stand-by after the sleep time has elapsed. Sleep time can be set in 10 minute intervals up to 180 minutes, as shown in the illustration. Setting the sleep time to zero turns off the sleep timer.

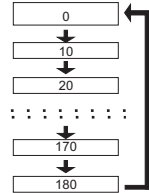

1 Press the TIME button, and the TIME menu appears on the screen.

2 Press the P+/- buttons to select "SLEEP TIMER".

3 Press the V-/+ buttons to set the value of the SLEEP TIMER.

TIME	
CLOCK	17:18
ON TIME	18:00
ON PROG	8
OFF TIME	23:00
SLEEP TIMER	120
REMIND TIME	--:--
REMIND PROG	1

### REMIND PROG function

Program remind timer, that can automatically change channel when a program on a different channel is due to start.

1 Press the TIME button, and the TIME menu display on the screen.

2 Press the P+/- buttons to select "REMIND TIME", then press the V-/+ buttons to set the value in hour position; press again the P+/- buttons to select the minute position, and then set the value of the minute (take 19:00 as an example).

3 Press the P+/- buttons to select "REMIND PROG", then press the V-/+ buttons or the program direct number buttons to set the desired channel (take 18 as an example).

NOTE: For REMIND PROG to operate CHILD LOCK must be turned off.

TIME	
CLOCK	17:18
ON TIME	18:00
ON PROG	8
OFF TIME	23:00
SLEEP TIMER	120
REMIND TIME	19:00
REMIND PROG	1

TIME	
CLOCK	17:18
ON TIME	18:00
ON PROG	8
OFF TIME	23:00
SLEEP TIMER	120
REMIND TIME	19:00
REMIND PROG	18

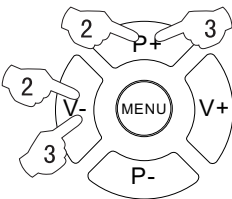
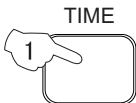
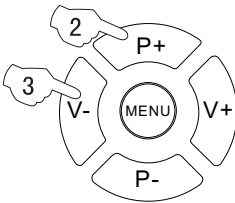
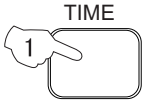

# Set up function

## Screen saver and Calendar

### How to start screen saver function

When the background function is ON a bouncing 'NO SIGNAL' will be displayed on a blue background.

NO SIGNAL

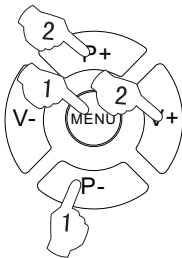

1 Press the **MENU** button. The *MAIN MENU* will appear with the *PIC* (picture) icon flashing. Press the **MENU** button a further 2 times until the *FUN* (function) icon is flashing. Press **P-** to enter the *FUNCTION* menu.

2 Press the **P+/-** buttons to select **BACKGROUND**. Then press **V+/-** to turn the **BACKGROUND** function ON or OFF.



BACKGROUND  
BLACK STRETCH  
NOISE REDUCE  
FADE  
AVL

ON

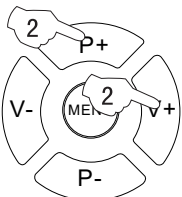

### Calendar function

1 Press the **CALENDAR** button. The calendar menu will be displayed on the screen.

The date on the top line is in Year/ Month /Day format.

2 Press the **P+/-** buttons to highlight the year, month or day number. Press the **V+/-** buttons to set or change each number.

SOLAR 2001 11 14

S	M	T	W	T	F	S
				1	2	3
4	5	6	7	8	9	10
11	12	13	14	15	16	17
18	19	20	21	22	23	24
25	26	27	28	29	30	

Press EXIT or wait a minute for the calendar to disappear.

# Set up function (Continued)

## AVL

### AVL function

Automatic Volume Level control reduces the effect of large volume changes. For instance, when advertisements come on.

1 Press the **MENU** button. The **MAIN MENU** will appear with the **PIC** (picture) icon flashing. Press the **MENU** button a further 2 times until the **FUN** (function) icon is flashing. Press **P-** to enter the **FUNCTION** menu.

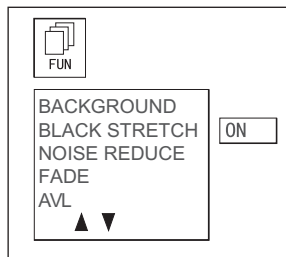
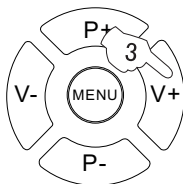
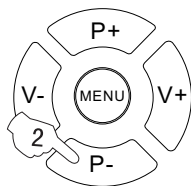
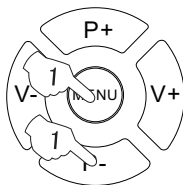

2 Press the P+/- button to select "AVL" .

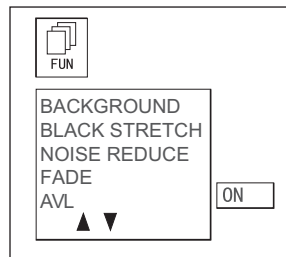

3 Press V-/+ button to turn the AVL function "ON" or "OFF".

### ORGANISE

This feature enables TV programmes that may be on a wrong program number to be moved to another number.

This feature is very useful when Automatic Search Tuning has been used because programmes are stored in the order they are found, which is usually not the desired order.

When organising, it is best to start from the lowest programme number first.

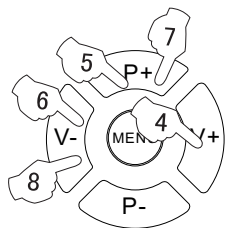
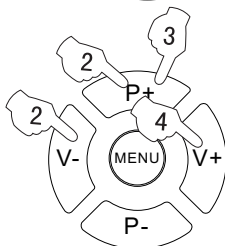
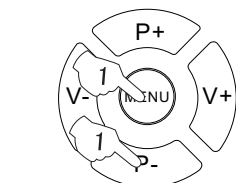

1. Press the MENU button. The MAIN MENU will appear with the PIC icon flashing. Press the MENU button a further 3 times until the TUN icon is flashing. Press P- to enter the TUNING menu.

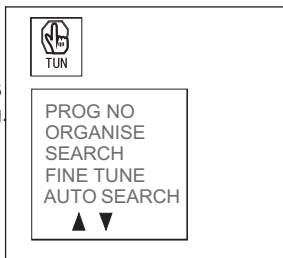

2. Press P+ or P- buttons to select ORGANISE. Press V+ to enter the menu.

(For Example) If the Automatic Search function has placed BBC1 on programme position 6 and you would like to move this so it appears on programme position 1.

3. Use P+ or P- to select "FROM".
4. Press V+ or V- to change the "FORM" programme number to 6.
5. Use P+ or P- to select "TO".
6. Press V+ or V- to change the "TO" programme number to 1.
7. Use P+ or P- to select "MOVE CHANNEL".
8. Use V+ or V- to perform the action.

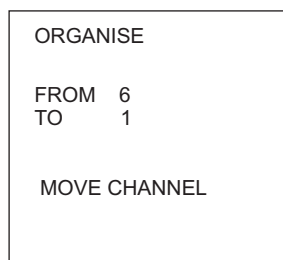

The diagrams below explain how the ORGANISE function affects other channels when position 6 is moved to position 1.

Start Position	Move FROM 6, TO 1	Other programmes move down to allow for space
P 01 Contents	P 01 Contents Contents	P 01 Contents
P 02 Contents	P 02 Contents	P 02 Contents
P 03 Contents	P 03 Contents	P 03 Contents
P 04 Contents	P 04 Contents	P 04 Contents
P 05 Contents	P 05 Contents	P 05 Contents
P 06 Contents	P 06 Contents	P 06 Contents

- What was on programme position 6 is now on programme position 1.
- All the other stored channels have now moved down 1 position so that now.
- What was on programme position 1 is now on programme position 2.
- What was on programme position 2 is now on programme position 3.
- What was on programme position 3 is now on programme position 4.
- What was on programme position 4 is now on programme position 5.
- What was on programme position 5 is now on programme position 6.

Note: It needs some time to move two channels, please wait till the TV finishes the process.

## Setting the Lock

- This TV set provides the option of locking various parts of the TV to guard against unauthorised viewing.

### Changing your password

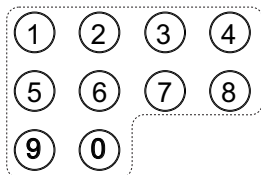
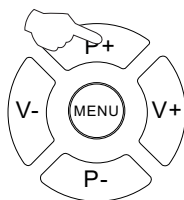

#### Changing your password

This TV set can set a four digit password, the original one is 0000, if you want to reset it, please follow the instructions below.

1 Press H.LOCK button, the screen will show as the form on the right.

INPUT PASSWORD ----

2 Press the 0 button four times, and enter the menu of LOCK setting. Press P+/- button and move the indicator to CHANGE PW., and press V+ button to enter the sub-menu of change password.

LOCK SET	
CHANGE PW.	
TUNING LOCK	OFF
PRESET PROG	1
AV LOCK	OFF
CHILD LOCK	OFF
MAX VOLUME	50
UNLOCK	

3 Press the PROGRAM NUMBER (0-9) button and input a four-digits password.

CHANGE PW.  
NEW PASSWORD----  
CONFIRM ----

4 After inputting your new password, please confirm it by keying it in again. You can now enter the lock settings using your new password.

# Setting the Lock(continued)

## Setting the Lock

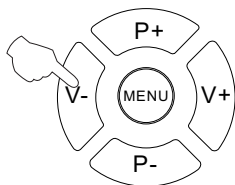
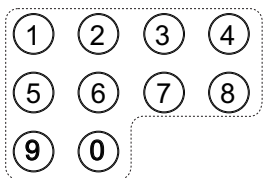
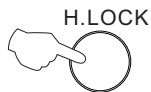

### Setting the Lock

There are TUNING LOCK, AV LOCK, and CHILD LOCK, etc., you can set it due to your need.

1 Press the H.LOCK button, the screen will show as the form on the right.

INPUT PASSWORD ----

2 Press the PROGRAM NUMBER (0-9) button 0 for four times (or input the password you set), and enter the LOCK menu.

LOCK SET	
CHANGE PW.	
TUNING LOCK	OFF
PRESET PROG	1
AV LOCK	OFF
CHILD LOCK	OFF
MAX VOLUME	50
UNLOCK	

3 Press P+/- button, move the indicator to the lock function you require and press V+ or V- button to set it ON or OFF, change setting or activate it.

### Description of each lock function

1. When the TUNING LOCK is set ON, if you want to enter the TUNING menu, you will have to type the password.
2. The PRESET PROG allows the TV to always be on the same channel when you turn it on.
3. When AV LOCK is set ON the AV channel cannot be used, hence the screen will indicate that AV has been locked.
4. When the CHILD LOCK is set ON, if the buttons on the TV are pressed, the screen will indicate that the TV set is in the status of CHILD LOCK, and the buttons won't work.
5. The MAX VOLUME allows you to set a figure for the top limit of volume. Volume control still shows 1-100 but volume level is scaled down.
6. The UNLOCK allows you to set all the lock to OFF and set the MAX VOLUME to 100.
7. If you forget your password or a password is accidentally set enter 9443 as the password. This will enable you to regain control.

# Basic Playback

## Basic Playback

### Preparations

- Press the DVD/TV button on the remote control or the TV to turn on the DVD player.

### Basic playback

1. Press OPEN/CLOSE to open the disc tray, place a disc on the disc tray.  
There are two different disc sizes. Place the disc in the correct guide on the disc tray. If the disc is out of the guide, it may damage the disc and cause the DVD player to malfunction.
  - Do not place a disc which is unplayable in this DVD player (see "Playable discs").
2. Press OPEN/CLOSE to close the disc tray, the playback will automatically start.
  - Some discs do not start automatically. Press PLAY/ENTER to start playback.
3. Some discs may start playback with a menu. Use the cursor buttons on the remote control to select menu options and press PLAY/ENTER to start. You may also press the digit buttons to select a menu option directly. Many DVDs will not allow this during start-up.

### Pause playback

1. Press PAUSE/STEP to pause playback (still mode).  
The sound will be muted during still mode.
2. Press PLAY/ENTER to resume normal playback.

### Stop playback

1. Press STOP ■ button to go to stop mode, the TV screen will show the start logo. For some discs the player can recall the location where stopped, such as DVDs and audio CDs.
2. Press PLAY/ENTER to resume play-back from the location where playback was stopped.
3. Press STOP twice to stop completely.  
Play must then resume from the title beginning.

### Previous and Next

During Playing, pressing the PREV ◀ key will restart the current chapter and skip chapters backwards with each subsequent press until the start of the disc is reached.  
Each press of NEXT ▶ key during playing will skip the current chapter and play the next one.  
In the case of CD audio and photo discs the next track, song or photo is selected.

### Fast forward and Fast reverse

1. Press FWD ►► to fast forward through the disc.  
Each time the FWD ►► button is pressed, the fast forward motion speed changes.
2. Press PLAY/ENTER to resume normal playback.
3. Press REV ◀◀ to fast reverse through the disc.  
Each time the REV ◀◀ button is pressed, the fast reverse motion speed changes.
4. Press PLAY/ENTER to resume normal playback.

### Single step playback

1. When paused, press PAUSE/STEP repeatedly to single step forward frame by frame in the video.
2. Press PLAY/ENTER to resume normal playback.



# Advanced Playback

## Advanced Playback

### IMPORTANT NOTE:

ALL DESCRIBED FUNCTIONS ARE FOR DVD DISCS. There will be some differences for other kinds of disc.

#### SUBTITLE

Press "SUBTITLE", the screen will display "SUBTITLE 01/XX XXXXX", "01" indicates the ordinal number of this language; "XX" indicates total number of language; "XXXXXX" indicates the language of country. (the number of language depends on disc). This function can select up to 32 languages displayed on screen.

#### REPEAT

Press "REPEAT" and Chapter repeat will be displayed on screen, the second press will display Title repeat, the third press will display All repeat, the fourth press will cancel this function.

#### A-B

Press A-B to select the Start point. Press again to select the End point. A third press will cancel the function.

#### ANGLE

When enjoying sports, concert or theatre, press this key to watch same actions in different angles. (Valid for discs possessing this function) Using a disc recorded in multi-angle you can view the scene from different angles, for example, front, side, whole view and exterior scene.

#### D.MENU

Press this key to display root menu, select item according to your preference. (This function will work with a DVD having a multi-layer menu.)

#### D.CALL

Pressing this key will cycle through "title elapsed", "title remain", "chapter elapsed", "chapter remain" and "display off". Each displays the appropriate time information.

#### PROGRAM

When playing discs, press "PROGRAM" to enter program mode. Starting with program number "01" highlighted, press the digit buttons to select the title and chapter number that you want. When finished move the cursor to select "START". This will start the program playback.

#### SEARCH

Press "SEARCH" once to display Disc Go To --:--, use numeric key to enter the desired time of Disc. Press "SEARCH" twice to display Track Go To --:--, use numeric keys to enter the desired time of track. Press "SEARCH" 3 times to display Select Track --/03, use numeric keys to enter the desired track.

#### SLOW

Press SLOW to play a disc in slow forward. Each time the SLOW button is pressed, the slow motion speed changes.

Press PLAY/ENTER to resume normal playback;

**Note:** This function is invalid for CD.

#### TITLE/PBC

With some DVD discs pressing this key will display the title menu. You can then use the digit buttons to select the item you prefer.

#### AUDIO

Press this key can change the audio mode.

such as: Audio 1/2: AC 3 2 CH English

Audio 2/2: AC 3 5.1 CH English

For CD audio, press this button to cycle between Mono Left, Mono Right, Mix-Mono and Stereo.

**Note:** When press this button continuously, you must above 3 seconds interval.

## Special Function Playback

### JPEG DISC PLAYBACK

Users can record pictures from digital camera or scanner onto a CD-R or CD-RW disc using a personal computer, CD recording drive and suitable software. Be sure to use good quality recordable discs and trustworthy software with good instructions. Take care with recording settings: the disc must be recorded as data disc ISO9660 format, short file names (8 characters) are best, no multi-session and must be "finalised".

JPEG disc contains pictures in a compact file format which can be decoded by the DVD player and output for viewing and enjoyment on the television screen.

When a disc containing standard JPEG picture files is inserted into the player, a navigation menu will be displayed automatically. Use the UP and DOWN cursor buttons to select a file then press PLAY/ENTER. The slide show will commence. Press PREVIOUS or NEXT to move between pictures. Press pause to stop on the current picture. Press PLAY/ENTER to resume normal playing.

Press MENU to go back to folder and file view.

Press STOP to display thumbnail picture menu then select "Menu" on-screen with the cursor buttons, press PLAY/ENTER to step through help menu for JPEG viewing controls. "Transition Effect" changes how one picture changes to the next in the "slide show".

Program button changes between folder and file list.  
Some repeat functions can be used.

Zoom functions are not included.

### SCREEN SAVER FUNCTION

This unit employs a screen saver mode to help protect the tube during static video pictures. This can be turned off on the GENERAL SETUP PAGE (see Pg. 26)

# DVD System Setup

## DVD System Setup

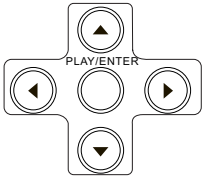
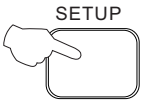

### General Setup Process

1. Press the SETUP button, the General Setup Page, Preference Page and Password Setup Page will be displayed in turn.
2. Press ▲ or ▼ to select, the item, then press ► to enter the submenu.
3. Press ▲ or ▼ to setup, then press PLAY/ENTER to confirm.
4. Press SETUP button to exit the menu.

```
..General Setup Page..
TV Display  LB  4: 3:Ps
Angle Mark  On  4: 3:Lb
OSD Lang    ENG 16: 9
Spdif Output
Caption     On
```

```
..Preference Page..
TV Type  Auto  PAL
Parental  AUTO
Password  NTSC
Default
```

### General Setup Page

#### ASPECT RATIO DESCRIPTION

When using the DVD with the internal TV, select 4: 3/LB.

*The following information applies only when the DVD output is connected to an external TV.*

- 4: 3/PS (PS = Pan and Scan)

You may select if you have a normal aspect ratio (4:3) TV, although the NORMAL/LB (letter box) is a more common choice. In PS

mode, widescreen material will fill the screen, but at the expense of chopping off extreme left and right edges of the original film picture. For this feature to work, the disc must be specially coded. Such discs are uncommon.

- 4: 3/LB (LB = Letter Box)

You may select this if you have a normal aspect ratio (4:3) TV. Widescreen material will be shown in pure unaltered form, allowing the entire picture area of the original film to be viewed without any side cropping. Black bars will appear above and below the picture.

- 16: 9

You may select this if you have a widescreen (16:9) TV. Black bars may still appear above and below the picture even if using a widescreen TV. This is because some film directors prefer to use ultra widescreen aspect ratios e.g. 2.35:1. This will normally be indicated on the DVD packaging.

```
..General Setup Page..
TV Display  LB  4: 3:Ps
Angle Mark  On  4: 3:Lb
OSD Lang    ENG 16: 9
Spdif Output
Caption     On
Screen Saver Off
```

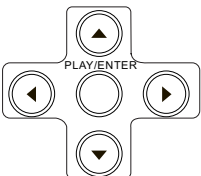
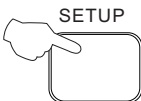

# DVD System Setup(Continued)

## DVD System Setup

### General Setup Page

**ANGLE MARK:** Users can select a particular camera angle when playing a DVD which offers multiple angles.

This item allows you to set Angle Mark ON or OFF.

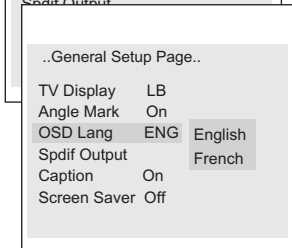
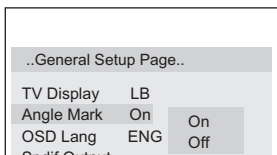

**On Screen Display (OSD) Language:** Users can select on-screen display language.

**SPDIF OUTPUT MODE:** Sets the audio outputs.

This DVD player includes three kinds of audio output:

1. **SPDIF OFF:** An analog surround sound format is output through the back-panel connections for 2-CH audio out or 5.1 CH audio out.
2. **SPDIF/RAW or SPDIF/PCM:** This surround sound format is output to a Dolby Digital/DTS decoder through the coaxial connector on the back panel of the product.

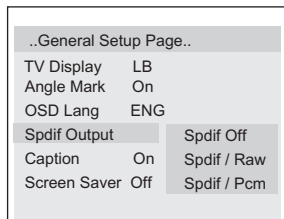

**CAPTIONS:** This function allows you to display or hide the caption.

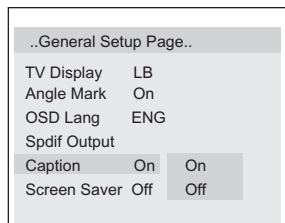

**SCREEN SAVER:** If the screen saver is on, then there will be an animated picture of DVD on the screen whenever the DVD player is idle for more than 3 minutes .

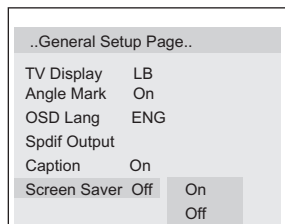

# DVD System Setup(Continued)

## DVD System Setup

### Preference Page

The Preference Page is only available when there is no disc in the player. These settings are applied consistently to all discs which are inserted and played.

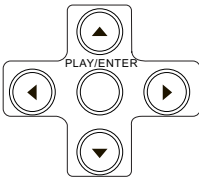
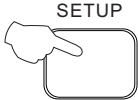

**TV TYPE:** This player supports different TV output, including MULTI(Auto), NTSC, and PAL systems. Usually please set to MULTI.

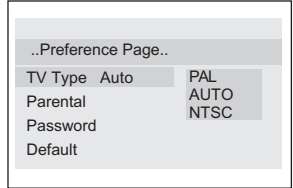

**PARENTAL:** The parental control function works in conjunction with the different censorship classes assigned to DVDs. These classes help to control the types of DVDs that the family watches, There are up to 8 censorship classes for DVDs.

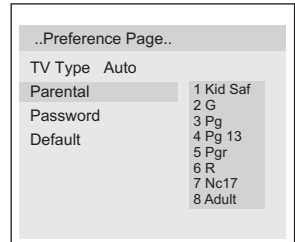

#### Note:

- 1 To change this setting you must enter your password. (Initial password is 1234)
- 2 When set to OFF, all discs may be viewed.

### PASSWORD CHANGE:

You can change your password by entering 4 digits. You must confirm the 4 digits before the new password can be accepted.

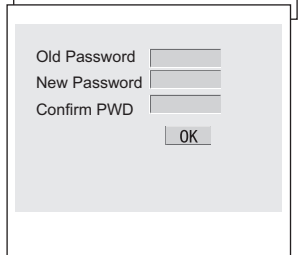
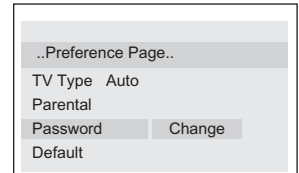

NOTE: If you forget your password or a password is accidentally set enter 1369 as the password. This will enable you to regain control.

# DVD System Setup(Continued)

## DVD System Setup

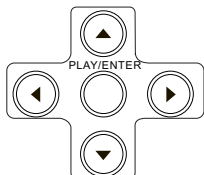
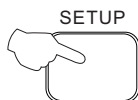

**DEFAULT:** Resets all settings (except password and parental lock status) for this DVD player back to the manufacturers original settings. Press ENTER to perform the reset.

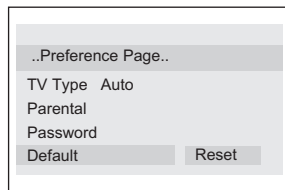





**Note:**

Some functions may not be available depending on the type of disc.

## Playable Discs

The following discs can be played:

DISCS	LABEL	CONTENTS	DIMENSION
DVD VIDEO		Audio +Video (moving picture)	12cm
			8cm
AUDIO CD		Audio	12cm
			8cm
HDCD		Audio	12cm
			8cm
JPEG		Video(picture)	12cm
			8cm
KODAK CD		Video(picture)	12cm
			8cm
CD-R	<b>CD•R</b>	Audio or Video (moving picture)	12cm
			8cm
CD-RW	<b>CD-RW</b>	Audio or Video (moving picture)	12cm
			8cm
<b>CD+G</b>	<b>CD+G</b>	Audio(picture)	12cm
			8cm

- You cannot play discs other than those listed above.
- You cannot play non-standard discs, even if they may be labelled as above.
- The performance of CD-R or CD-RW discs depends on the way the disc is prepared - see under "Special function playback - JPEG disc playback".

# Disc Protection and DVD Characteristics

## ON HANDLING DISCS

- Do not touch the playback side of the disc.
- Do not attach paper or tape to disc.

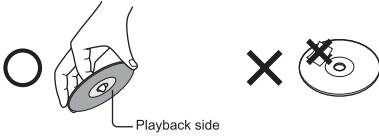

## ON CLEANING DISCS

- Fingerprints and dust on the disc cause picture and sound deterioration. Wipe the disc from the centre outwards with a soft cloth. Always keep the disc clean.



- If you can not wipe off the dust with a soft cloth, wipe the disc lightly with a slightly moistened soft cloth and finish with a dry cloth.
- Do not use any type of solvent such as thinner, benzene, commercially available cleaners or anti-static spray for vinyl Lps. It may damage the disc.

## ON STORING DISCS

- Do not store discs in a place subject to direct sunlight or near heat source.
- Do not store discs in place subject to moisture and dust such as a bathroom or near a humidifier.
- Store discs vertically in a case. Stacking or placing object on discs outside of their case may cause warping.

## STRUCTURE OF DISC CONTENTS

Normally, DVD discs are divided into titles, and the titles are sub-divided into chapters. Audio CD are divided into tracks.

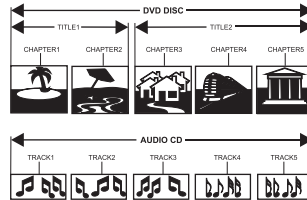

Each title, chapter, or track is assigned a number, which is called title number, chapter number or track number respectively.

There may be discs that do not have these number.

## Compare DVD disc with other discs:

	DVD				LD	SVCD	VCD	CD
Encode method	Digital/MPEG II				Analog	Digital	Digital/MPEG I	Digital
Capacity	Single-side single-layer 4.7G	Double-side single-layer 8.5G	Single-side double-layer 9.4G	Double-side double-layer 17G	/	650MB	650MB	650MB
Playing Time	133 minutes	242 minutes	266 minutes	484 minutes		Single-side 60 minutes double-side 120 minutes	45 minutes	74 minutes
Disc diameter	12cm/8cm				30cm/20cm	12cm	12cm	12cm/8cm
Horizontal resolution	More than 500 line				No more than 430 line	No more than 350 line	No more than 250 line	/
Picture proportion	Multiple kinds				One kind	One kind	One kind	
Subtitle	32 kinds				16 kinds at most	4 kinds	/	/
Language	8 kinds				4 kinds at most	4 kinds at most		
Sound quality	48KHz, 96KHz/ 6, 20, 24bit				44.1KHz/ 16bit	44.1KHz/ 16bit	44.1KHz/ 16bit	44.1KHz/ 16bit



# Connecting the TV set to the other video and audio equipment

## Connection of AV input /output terminal

The figure below shows how to connect external equipment using AV signals.

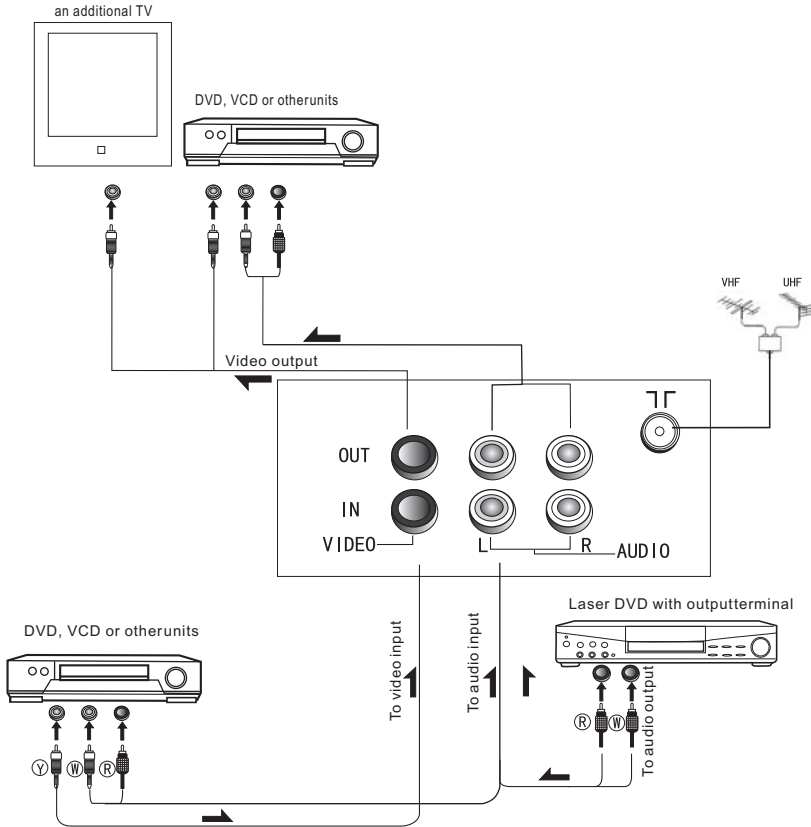



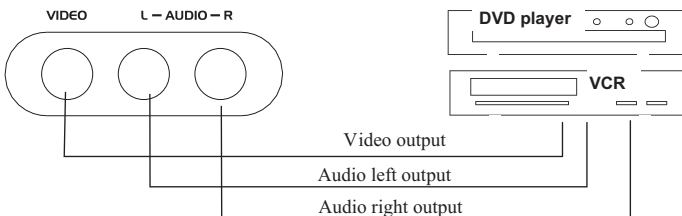













There is also an AV input on the side of your television. Use the Left Audio input (white terminal on the TV), if you are connecting equipment with mono sound. The MONO sound will be delivered by both left and right speakers.

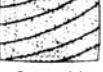

## Troubleshooting guide

- To assist in location possible faults use help guide below.

BREAKDOWN PHENOMENON		CHECKING
PICTURE	SOUND	
 Picture with snow	 Noise	The aerial direction and connection
 Double or Triple Image	 Normal	This is called ghosting which can be minimized with an outside aerial, and good quality cable and terminations. Altering the aerial direction can also minimize this effect.
 Disturb	 Noise	Electrical interference which can be caused by cars, motorbikes etc, Fluorescent lamps and dirty insulators on overhead power cables.
 Normal	 No sound	Volume Sound mute
 No Picture	 No sound	Ensure that the power supply is connected to the TV set and turned on. Also ensure that the TV set is not in "Listen Mode" or that the brightness and contrast are not turned down.
 No colour	 Normal volume	Adjust colour control
 Scramble	 Normal or Weak Volume	Adjust channel again
 Colour Spot	 Normal volume	Colour Purity fault which can be caused by moving the TV set, placing magnets near the TV screen or turning on/off house hold appliances such as vacuum cleaners near the TV set. Turn the TV off with the mains power switch for 15 minutes. When the power is turn on again the TV set will automatically demagnetise the screen. In severe cases you may need to repeat this process.

### Note:

1. If the fault can not be repaired using the above guide consult with your local authorized service center.
2. The TV set must only be repaired by a qualified registered service person. Never attempt to remove the back cover as TV set has dangerous voltages inside that may cause a fatality or fire.
3. The cabinet may produce the occasional "snapping sound" This is normal and caused by the materials in the cabinet expanding with room temperature changes.

# Specifications

## Specifications

Model	5115DVD
Colour system	PAL, NTSC PLAYBACK
Sound system	BG
Picture tube	51cm colour picture tube
Sound output power	2X2W (10% THD)
Power requirements	AC 240V~ 50Hz
Power consumption	80W
Dimension (mm)	500 (Width) x480 (Depth) x485 (Height) (mm)
Accessories	Remote control           x1 Owner's manual           x1 Battery(AA)                x2

### NOTE

Design and specifications are subject to change without notice.  
The dimension in this manual is a approximation.

## Free Manuals Download Website

<http://myh66.com>

<http://usermanuals.us>

<http://www.somanuals.com>

<http://www.4manuals.cc>

<http://www.manual-lib.com>

<http://www.404manual.com>

<http://www.luxmanual.com>

<http://aubethermostatmanual.com>

Golf course search by state

<http://golfingnear.com>

Email search by domain

<http://emailbydomain.com>

Auto manuals search

<http://auto.somanuals.com>

TV manuals search

<http://tv.somanuals.com>