

AUTOMATIC DRUM WASHING MACHINE

USER MANUAL

HW90-1482



Haier

BEFORE USE

>COMPONENTS	03
>PREPARATION	04
>SAFETY INSTRUCTIONS.....	05
>INSTALLATION.....	06
>CONTROL PANEL	08

USING THE APPLIANCE

>PROGRAM SELECTION.....	10
>CONSUMPTION AND TECHNICAL DATA ..	11
>WASHING METHODS	12

MAINTENANCE

>CLEANING & CARE.....	16
>DISPLAY CODES	18
>TROUBLESHOOTING.....	19

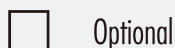
LEGEND

For your safety, any instructions in this manual with this "Warning" sign must be followed strictly.

DISPOSAL

The symbol on the product or on its packing indicates that this product may not be treated as household waste. Instead it shall be handed over to the applicable collection point for the recycling of electrical and electronic equipment. By ensuring this product is disposed of correctly, you will help prevent potential negative consequences for the environment and human health, which could otherwise be caused by inappropriate waste handling of this product. For more detailed information about recycling of this product, please contact your local city office, your household waste disposal service or the shop where you purchased the product.

COMPONENTS

THANKS FOR PURCHASING A HAIER PRODUCT

Please read these instructions carefully before using this appliance. The instructions contain important information which will help you get the best out of the appliance and ensure safe and proper installation, use and maintenance.

Keep this manual in a convenient place so you can always refer to it for the safe and proper use of the appliance.

If you sell the appliance, give it away, or leave it behind when you move house, make sure you also pass on this manual so that the new owner can become familiar with the appliance and safety warnings.

ACCESSORIES

Check the accessories and literature in accordance with this list:

1x Inlet hose assembly

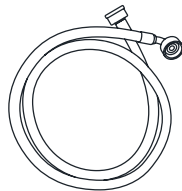

1x Bottom Cover



1x User manual



1x Drain hose bracket

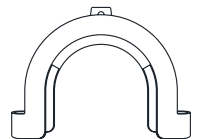

4x Blanking plugs



04 BEFORE USE

PREPARATION

PREPARING THE MACHINE

Remove all the packing materials to prevent unsteadiness, including the polystyrene base. Upon opening the package, water drops may be seen on the plastic bag and the porthole. This is normal phenomenon resulting from water tests in the factory.

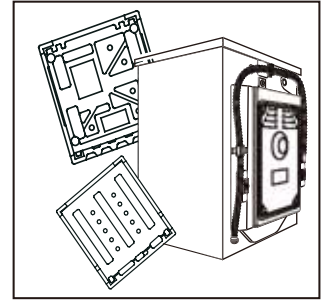

DESCRIPTION

This diagram may be slightly different from the layout of the washing machine you have just purchased due to technical improvements.

Control panel

Power

Work top

Door handle

Washer door

Detergent distribution drawer

Filter cover

Drain hose

Water inlet valve

Power cord

Back cover screws

Back cover

Transportation bolts

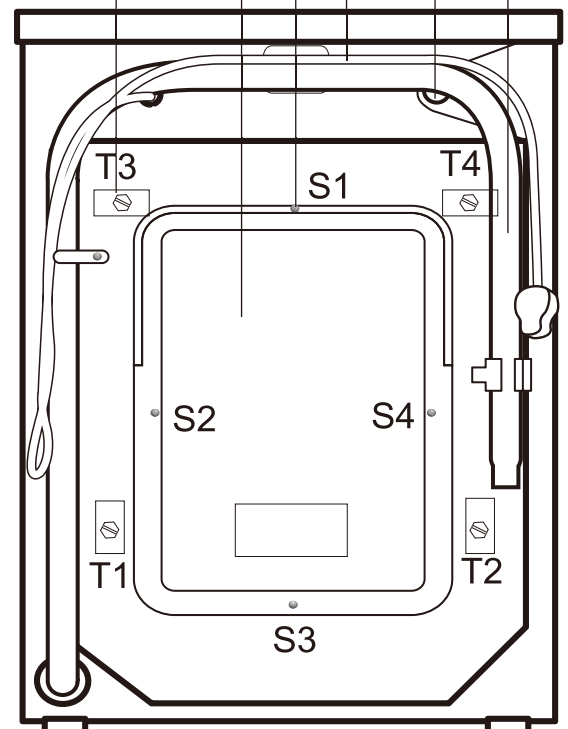



SAFETY INSTRUCTIONS

BEFORE SWITCHING THE APPLIANCE ON FOR THE FIRST TIME

DO ...

- ... Make sure that the transport bolt are removed.
- ... Use a separate earthed socket for the power supply.
- ... Make sure that the plug is accessible.
- ... Hold the plug and not the electric cable when unplugging the power supply.
- ... Make sure that the fuses in the power circuit are rated for 15A.
- ... Keep away from heat sources and direct sun light to prevent plastic and rubber components from aging.
- ... Make sure that the power cord is not caught under or in the appliance and avoid damage to the power cable.
- ... Check that hose joints and connections are firm and no water can leak. If joints are loose or there is leakage, turn off the water supply and refix. Do not use the washing machine until the hoses are properly fixed.

DURING DAILY USE OF THE APPLIANCE

DO ...

- ... Pull up zips and fix loose threads to prevent the items from being entangled. If necessary, put small items into a net bag or pillow.
- ... Turn off the machine after each wash program and switch it off at the mains to save electricity and for safety. Wipe clean the lower part of the porthole.
- ... Keep the door slightly open when the washing machine is not in use to prevent formation of odours.
- ... Let the power cord be replaced by the manufacturer, his service agent or other accordingly qualified persons, in case it is damaged.
- ... Ensure that the appliance is not used by persons with reduced physical, sensory or mental capabilities, lack of experience and knowledge without supervision or instruction by a person responsible for their safety.
- ... Supervise children to ensure that they do not play with the appliance.

DO NOT ...

- ... Touch or use the appliance when barefoot or with wet or damp hands or feet.
- ... Use flammable detergent or dry cleaning agent.
- ... Use any flammable sprays in close vicinity to the appliance.
- ... Remove or insert the plug in the presence of flammable gas.
- ... Allow children or infirm persons to play with the appliance or packing materials.
- ... Install the appliance outdoors in a damp place, or in an area which may be prone to water leaks such as under or near a sink unit. In the event of a water leak allow the machine to dry naturally.
- ... Place the washing machine directly on a carpet, or close to a wall or furniture.

DO NOT ...

- ... Touch the washer door during the washing process - it gets hot!
- ... Place heavy objects or sources of heat or damp on top of the appliance.
- ... Hot wash foam rubber or sponge-like materials.
- ... Open the detergent distribution drawer during the wash cycle.
- ... Force the washer door open. The door is fitted with a self-lock device and will open shortly after the washing procedure is ended.
- ... Open the washer door if the water level is visibly over the porthole.
- ... Cover the washing machine with plastic cover so that inside dampness cannot be kept in.

06 BEFORE USE

INSTALLATION

ADJUSTING THE BOTTOM COVER

Before removing the transportation bolts, please fix the bottom cover to the bottom of the washing machine. Lay down the machine (fig. 1.), screw off the feet and adjust the bottom cover with the four holes corresponding the screw holes of the feet. Then screw the feet back on through the cover and fix it thus securely to the bottom of the machine (fig. 2.).

It keeps out the dampness and reduces the noise.

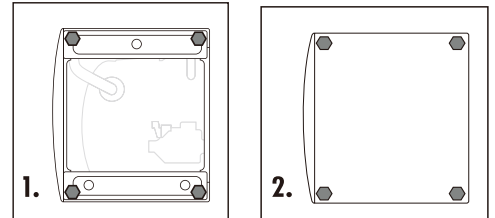

DISMANTLE THE TRANSPORTATION BOLTS

The transportation bolts are designed for clamping anti-vibration components inside of the washing machine during the transportation process.

1. Remove the back cover.
2. Remove the four bolts on the rear side and take out the synthetic stabilisers from within the machine.
3. Replace the back cover.
4. Fill the holes left by the bolts with blanking plugs.

Note:

- 1. When you replace the back cover, the convexity must face to outside, and you have to insert the back cover from the two gaps as shown in fig.5.**
- 2. Keep the transportation bolts and synthetic stabilisers in a safe place for later use.**

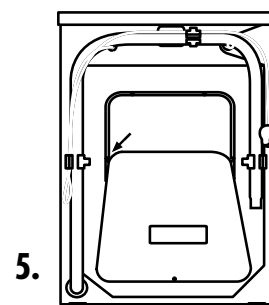
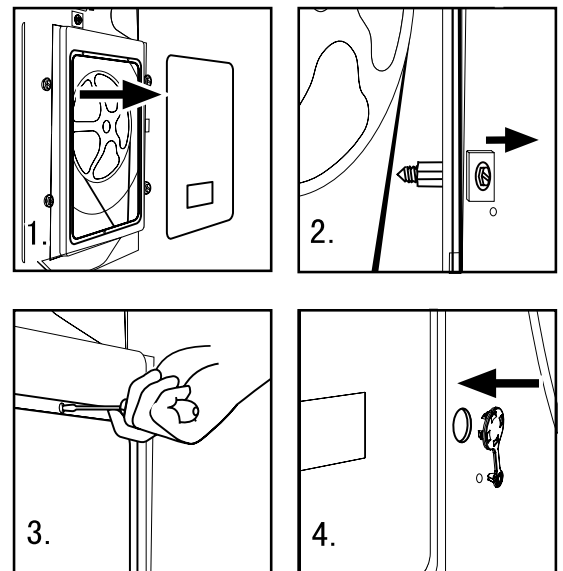

ADJUSTING THE WASHING MACHINE

There are adjustable feet under the bottom of the washing machine. Before use, they should be adjusted so that the machine is level. This will minimise vibrations and thus noise during use. It will also reduce wear and tear. We recommend using a spirit level to level the appliance. The floor should be as stable and flat as possible.

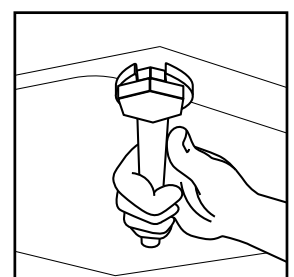

INLET HOSE

1. Connect the nut on the inlet hose to the connector on the water valve.
2. Apply inlet hose to a water tap with cold, fresh water.

Note: Use the hose-set supplied with the appliance. Old hose-sets should not be reused.

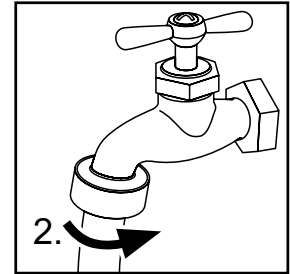
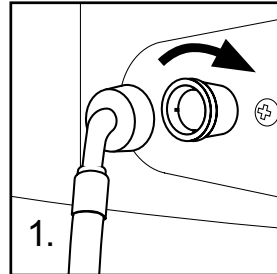

DRAIN HOSE

1. Use the drain hose bracket to keep the end of the drain hose retained and prevent the outflow of water. Don't extend the length of the drain hose; if an extended hose is required, please consult a serviceman.
2. The height of the drainage outlet must be 80-100 cm. Fix the drain hose to the clip at the back of the washing machine to prevent it from dropping off.

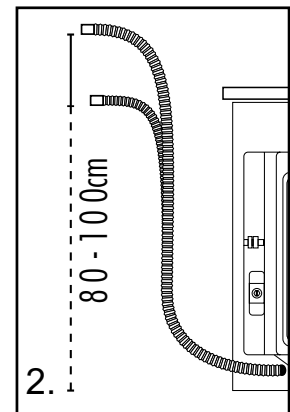
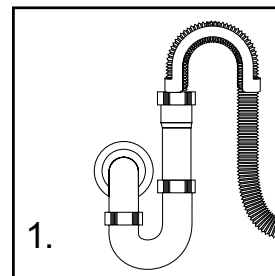

Note: The drain hose should not be submerged in water and should be securely fixed and leak-free. If the drain hose is placed on the ground or if the pipe is at a height of less than 80cm, the washing machine will continuously drain while being filled (self-siphoning).

CONNECTING TO THE POWER SUPPLY

Before connecting to the power supply, check:

- The socket is adequate for the maximum power of the washing machine (For safety, fuses in the power circuit should be rated for no less than 15A).
- The voltage should meet the requirement.
- The power outlet should be capable of accepting the washing machine plug.
- Connect the machine to an earthed socket outlet.

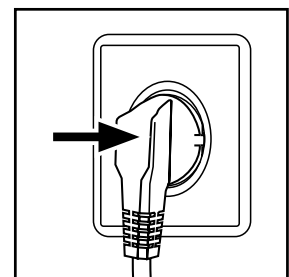

08 BEFORE USE

CONTROL PANEL

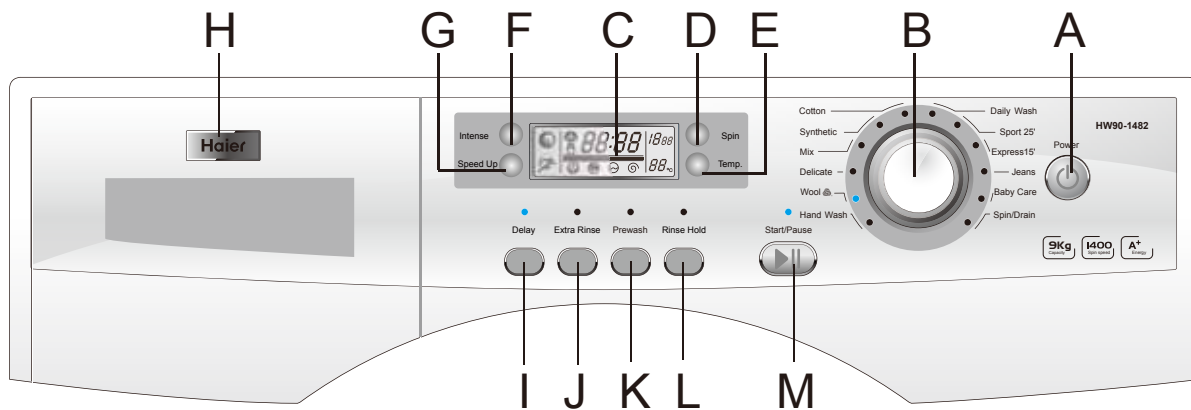

- | | | |
|----------------------------------------|----------------------------------------|-----------------------------|
| A Power Switch | F Intense washing button | K Prewash button |
| B Program knob | G Speed up button | L Rinse Hold button |
| C Display screen | H Detergent distribution drawer | M Start/Pause button |
| D Spinning Speed Setting button | I Delay button | |
| E Washing temperature button | J Extra rinse button | |

OPERATIONAL FUNCTIONS

- A** → Power Switch _ Press this button to switch on the washing machine. Press it again to switch it off. Press On/Off button gently for 2 seconds to switch off the machine as buttons are soft touch sensitive. The "End" sign will appear on the display after finishing the program. It will change to power off station if there is no operation on the button and none will be shown.
- B** → Program knob _ By turning the knob clockwise/counterclockwise, the required program can be selected. There are 12 programs available. After a program is selected, the corresponding light will go on.
- C** → Display screen _ Display washing time, remaining time, times of rinsing, spinning time, temperature setting value, speed setting value, child lock state, door lock state, washing progress and alarm message, etc.
- D** → Spinning Speed Setting Button _ Press the "Speed" button to select spinning speed. The maximum allowable spinning speed varies with programs.
Note: Different water temperatures and spinning speeds can be set for different laundries. Wash using the default settings if there is no special requirement.
- E** → Washing temperature button _ Press the "Temp." button to select heating temperature (-, 20, 30, 40, 50, 60, 70, 80, 90) °C. The maximum allowable heating temperature varies with programs.
Note: "--" in the temperature display indicates non-heated washing.

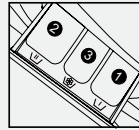
F	Intense washing button	Press "Intense " button to increase the washing time during the main washing stage of selected program.(This feature is applicable for dirty clothes) The illuminated icon indicates the function is selected. This button is effective before starting a program.
G	Speed up	This button is to decrease the washing time.This button is effective before starting a program. and the illuminated icon indicates that the function is selected.
H	→ Detergent distribution drawer	<p>_Open the drawer, three compartments can be seen:</p> <p>Compartment 1: Prewash detergent</p> <p>Compartment 2: Detergent for programs 1 to 11 .</p> <p>Compartment 3: Softener, conditioning agent, perfume, etc.</p>  <p>The recommendation on the type of detergents is suitable for the various washing temperatures, please refer to the manual of detergent.</p>
I	→ Delay Button	<p>Press the "Delay" button and the illuminated icon indicates that the "delay" function is selected. The delay time (0.5-24h) increases by 30 minutes each press of "Delay" button. The time will change continuously if you press and hold this button until you release it. The delay time is the end time of washing. For example, 6:00 means the washing ends after 6 hours (the delay time must be longer than the program's running time). The "Delay" function is not available for "Spin" program.</p> <p>Note:The delay time must be longer than the program time;otherwise,the washing machine will start the wash program directly.</p>
J	Extra rinse button	Press this button, the washing machine will perform additional rinses. Press the button once to select one additional rinse. The display will show "P--1". Press the button repeatedly and the screen will display "P--2" or "P-- 3", indicating two or three additional selected rinses. The "extra rinse light" is activated and flashes during the performance."P--1/2/3" is displayed alternating with the remaining time. The light turns off and the display disappears when the extra rinse ends.
K	Pre-wash button	Press the "Pre-wash" button to select or cancel the prewash program. The prewash program can be selected for washing heavily soiled clothes. Press the "Prewash" button, the "Pre-wash" icon will illuminate. Press the "Pre-wash" again, the prewash function will be cancelled and the "Pre-wash" icon will go out. When selecting the prewash function, add a proper amount of detergent into the prewash box, otherwise do not add any detergent into the prewash box. This additional function applies to "cotton", " Jeans ", "synthetic" " baby care " "dailywash " " mix " programs only.
L	Rinse Hold button	Press "Rinse Hold " button to startup/shutdown the crease-resistant and soak function. When the process runs to the last rinse, the washing machine is not going to drain, clothes will be soaked in water, and the soak icon flashes, the remain time not decreasing. If you need to continue the process, you can press " Rinse Hold "button or "start /pause"button, then the icon will be off to cancel this function, and the washing machine continue to work. This feature and the " Delay"button can not be chose at the same time. The function is not available for "Spin" and " Express 15' " programs.
M	→ Start/ Pause Button	_ Press the "Start/pause" button, the washer will start and the indicator light remains on. If this button is pressed when the washer is in operation, the washer will pause and the indicator light will flash.

10 USING THE APPLIANCE

PROGRAM SELECTION

PROGRAM MODES

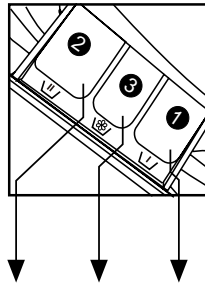

- 1 Detergent compartment for prewash mode
- 2 Detergent compartment
- 3 Compartment for softener and other additives

Program	Temperature Maximum	Preset	2	3	1	Recommended Laundry	Preset spin speed
1 → Hand Wash	-- to 90 °C	30°C	<input checked="" type="checkbox"/>	<input type="checkbox"/>	<input checked="" type="checkbox"/>	Cotton fabrics	400 rpm
2 → Wool	-- to 40 °C	30°C	<input checked="" type="checkbox"/>	<input type="checkbox"/>	<input checked="" type="checkbox"/>	Woolen fabrics	400 rpm
3 → Delicate	-- to 40 °C	30°C	<input checked="" type="checkbox"/>	<input type="checkbox"/>	<input checked="" type="checkbox"/>	Cotton fabrics	400 rpm
4 → Mix	-- to 40 °C	40°C	<input checked="" type="checkbox"/>	<input type="checkbox"/>	<input type="checkbox"/>	Cotton or synthetic	800 rpm
5 → Synthetic	-- to 60 °C	40°C	<input checked="" type="checkbox"/>	<input type="checkbox"/>	<input type="checkbox"/>	Chemical fiber fabrics	800 rpm
6 → Cotton	-- to 90 °C	40°C	<input checked="" type="checkbox"/>	<input type="checkbox"/>	<input type="checkbox"/>	Cotton fabrics	1000 rpm
7 → Daily Wash	-- to 60 °C	40°C	<input checked="" type="checkbox"/>	<input type="checkbox"/>	<input type="checkbox"/>	Cotton fabrics	800 rpm
8 → Sport 25'	-- to 40 °C	--	<input checked="" type="checkbox"/>	<input type="checkbox"/>	<input checked="" type="checkbox"/>	Sports wear	800 rpm
9 → Express 15'	-- to 40 °C	--	<input checked="" type="checkbox"/>	<input type="checkbox"/>	<input checked="" type="checkbox"/>	Cotton or synthetic	800 rpm
10 → Jeans	-- to 90 °C	40°C	<input checked="" type="checkbox"/>	<input type="checkbox"/>	<input type="checkbox"/>	Jeans	800 rpm
11 → Baby Care	-- to 90 °C	40°C	<input checked="" type="checkbox"/>	<input type="checkbox"/>	<input type="checkbox"/>	Cotton or synthetic	800 rpm
12 → Spin/Drain	--	--	<input checked="" type="checkbox"/>	<input checked="" type="checkbox"/>	<input checked="" type="checkbox"/>	None	1000 rpm

Yes No Optional

CONSUMPTION AND TECHNICAL DATA

CONSUMPTION TABLE

PROGRAM	MAX. LOAD	TEMPERATURE	WASHING TIME	ENERGY CONSUMPTION	WATER CONSUMPTION	SPIN DRYING PERFORMANCE
→ Hand Wash	2kg	30°C	1:10	/	/	/
→ Wool	1kg	30°C	0:59	/	/	/
→ Delicate	2kg	30°C	0:57	/	/	/
→ Mix	4.5kg	40°C	1:17	/	/	/
→ Synthetic	4.5kg	40°C	1:19	/	/	/
*) → Cotton	4.5kg	40°C	2:32	0.757kwh	46L	/
*) → Cotton	4.5kg	60°C	2:52	1.277kwh	46L	/
*) → Cotton	9kg	60°C	2:52	1.272kwh	62L	53%
→ Daily Wash	4.5kg	0°C	1:31	/	/	/
→ Sport 25'	4.5kg	--	0:25	/	/	/
→ Express 15'	2kg	--	0:15	/	/	/
→ Jeans	4.5kg	40°C	1:42	/	/	/
→ Baby Care	4.5kg	40°C	1:32	/	/	/
→ Spin/Drain	/	/	0:11	/	/	/

The standard 60 °C and 40 °C cotton programmes are suitable to clean normally soiled cotton laundry and they are the most efficient programmes in terms of combined energy and water consumptions for washing that type of cotton laundry; The actual water temperature may differ from the declared cycle temperature;

*) Energy Label Program Settings: 1. "Cotton+40°C+Intense+Max speed" ; 2. "Cotton+60°C+Intense+Max speed"

TECHNICAL DATA

HW90-1482

Power source	220 - 240V~/50Hz
Max. working current (A)	10
Water pressure (MPa)	0.03 ≤ P ≤ 1
Nominal load (kg)	9
Spinning speed (r/min)	1400
Washing programs	12
Max power (W)	2000
Dimensions (HxDxW mm)	850 x 650 x 595
Net weight (kg)	74
Power consumption of the off-mode (W)	0.48
Power consumption of the left-on mode (W)	0.48

12 USE THE APPLIANCE

WASHING METHODS

PLEASE NOTE

This washing machine is for domestic use only. If the machine is used for commercial purposes the guarantee will not be valid anymore. Do not use it for purposes other than that for which it was designed. Follow the instructions given on the label of each garment and wash only machine-washable garments.



POWER SUPPLY

Connect the washing machine to the power supply (220V to 240V~/50Hz).

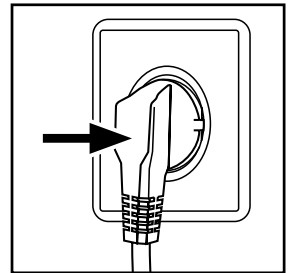

WATER CONNECTION

Turn on the tap. The water must be clean and clear.

Note: Before use, check for leakage in the joints between the tap and the inlet hose by turning on the tap.

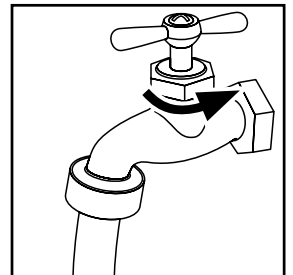

PREPARING THE LAUNDRY

- Sort out clothes according to fabric (cotton, synthetics, wool or silk) and to how dirty they are.
- Separate white clothes from coloured ones. Wash them first by hand to check if they fade or run.
- Empty pockets (clips, coins, keys, etc.) and remove the harder decorative objects (e.g. brooches) to avoid them entering the drain pump and blocking.

Attention: Small parts (like buttons, etc) may lead to repair work which user has to pay by themselves and can cause damage in the machine.

- Garments without hems, underwear, finely woven textile such as fine curtains are to be put into wash bag (it is better not to wash them in a washing machine).
- Close zippers and hooks, make sure the buttons are sewn on tightly and place small items such as socks, belts, bras, etc. in the wash bag.
- Unfold large pieces of fabric such as bed sheets, bedspreads, etc.
- Turn shirts inside out.

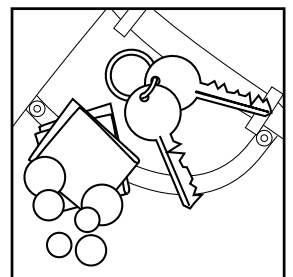
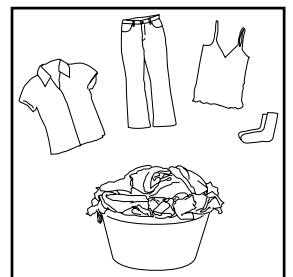

LOADING THE MACHINE

Open the washer door, put in the laundry piece by piece. Close the door tightly.

→ When first using the washing machine, let it run unloaded for one program to prevent the laundry from being tainted by oil or dirty water from the washing machine. Before washing you should run the machine without laundry, but with detergent, with 60°C program.

→ Do not overload the washing machine.



SELECTING DETERGENT

The washing efficiency and the performance is determined by the quality of detergent used. Special non-foaming detergent produces good washing results. Use specific detergents for synthetic and woollen goods. Do not use dry cleaning agents such as trichloroethylene and similar products.

Note: Do not add more detergent than needed; otherwise, it may cause the situations as following and washing machine malfunction impacting washing machine's life.

1. Due to the increasing foam, the rinse time will be longer than normal;

2. The foam may overflow from the detergent drawer because of the increasing pressure of the foam;

3. It may remain foam without cleaning out after the final spinning cycle.

Recommendation:

1. Clean the detergent drawer once a week.

2. When using the prewashing program, please add half of the rating dosage.

3. Please follow the dosage recommendation on the powder or liquid detergent package.

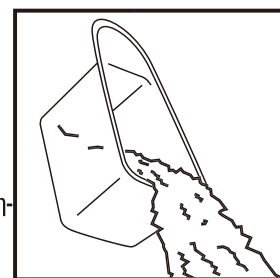

ADDING DETERGENT

Slide out the detergent drawer and put the required detergent and softening agent into the corresponding compartments. Push back the drawer gently. (Refer to the instructions on the drawer)

Caution:

→ **For prewashing program, detergent should be added to both compartments 1 and 2. For other programs, do not add detergent to compartment 1.**

→ **Add liquid detergent to the main drawer, and dilute it first if it is concentrated. Do not overuse detergent; otherwise, it will damage the artificial fibers. so, please follow the instructions on the detergent package. Do not use liquid detergent if the pre-wash mode or "delay" is selected.**

→ **Do not overuse softener; otherwise, it will damage the artificial fibers.**

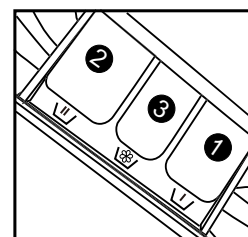

SELECTING PROGRAM

To get the best washing results, an appropriate washing program should be selected according to the laundry type. Please turn the program knob to select the right program.

SELECTING FUNCTIONAL

Select the required options. (Refer to the "Control panel" pages 08 and 09)

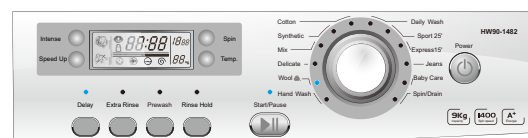

14 USING THE APPLIANCE

SETTING WASHING TEMPERATURE

Press and hold down the temperature button until the desired temperature is selected .

SETTING SPIN SPEED

Press and hold down the speed button until the desired speed is selected. See "Operational functions" on the "Control panel" pages (08 and 09) for selecting temperature and spin speed. It is advisable to select the recommended value.

WASHING

Press the Start/Pause button. The washing machine will operate according to the preset programs. The washing machine will stop operation automatically when a washing cycle ends. The "End" sign will appear on the display. Open the washer door and take out the laundry.

AFTER WASHING

Turn off the water supply and unplug the power cord. Open the washer door to prevent formation of moisture and odours. Let the door open while not used.

TIPS FOR SAVING ENERGY

1. Collect clothes for one full wash load.
2. Avoid overloading the washing machine.
3. Prewash only heavily soiled clothes.
4. Reduce the amount of detergent or choose standard or delicate wash programs for slightly soiled clothes.
5. Choose a proper washing temperature. Modern detergents can wash with very good result already in lower temperature than 60°C. Only use higher temperature than 60°C for heavily soiled laundry.
6. Follow the dosage recommendation on the detergent package to avoid using too much detergent.







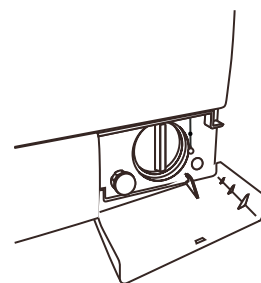
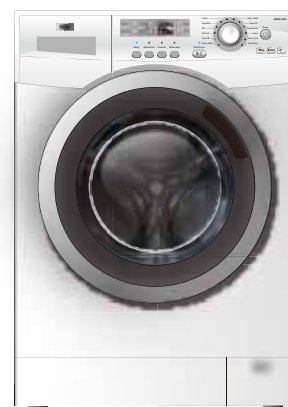
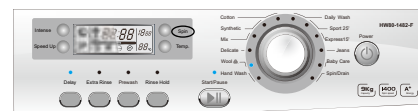





















WARM TIPS:

To add clothes during washing or want to remove clothes due to extended power failure, make sure that the water level in the drum is properly below the lower edge of sight glass, the water temperature is below 50°C and the inner drum is not running, then remove the drain pipe from its support and lower it until no water is drained from the drain pipe, replace the drain pipe. Press the Start/Pause button and the door will open , now you can add or remove the clothes.

If it is not suitable to open the door, using the pole can open it, but it is not a normal way.



CARE CHART

	Resistant material		Bleachable in cold water		Don't dry clean	
	Delicate fabric		Do not bleach		Dry flat	
		Washable at 95 °C		Iron at 200 °C		Hung to dry
		Washable at 60 °C		Iron at 150 °C		Dry on clothes hanger
		Washable at 40 °C		Iron at 100 °C		Tumble dry, normal heat
		Washable at 30 °C		Don't iron		Tumble dry, reduced heat
	Hand wash		Dry cleaning with any solvent		Don't tumble dry	
	Dry clean only		Dry cleaning with pericloride			
	Wool Seal		Dry cleaning with aviation fuel			

LOAD REFERENCE

Bed sheet (single)	Cotton	Approximately 800g
Blanket	Wool	Approximately 3000g
Blended fabric clothes	/	Approximately 800g
Jackets	Cotton	Approximately 800g
Jeans	/	Approximately 800g
Overalls	Cotton	Approximately 950g
Ladies Pyjamas	/	Approximately 200g
Shirts	/	Approximately 300g
Socks	Blended fabrics	Approximately 50g
T-Shirts	Cotton	Approximately 300g
Underwear	Blended fabrics	Approximately 70g

16 MAINTENANCE

CLEANING & CARE

AFTER WASHING

Turn off the water supply and pull out electricity plug after each wash. Open the washer door to prevent formation of moisture and odours. If the washing machine is left idle for a long period, drain the water in the machine and replace the drain hose.

CLEANING THE DETERGENT DRAWER

Clean the detergent distribution drawer regularly.

Swing out the drawer, flush it clean with water and then replace it.

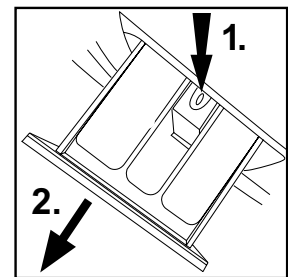
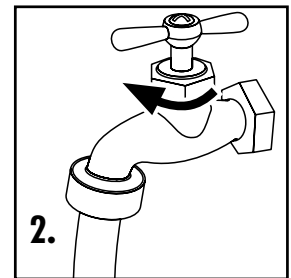
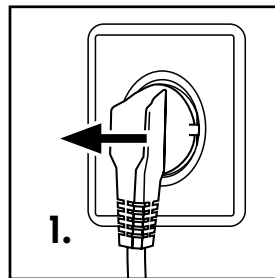

CLEANING THE MACHINE

Unplug the machine during cleaning and maintenance. Use a soft cloth dampened with soap liquid to clean the machine case and rubber components. Do not use organic chemicals or corrosive solvents.

CLEANING THE FILTER

Clean the filter once a month:

1. Open the bottom cover.
2. Remove the filter by turning counterclockwise.
3. Flush the filter clean with running water.
4. Replace the filter by turning clockwise and remount the cover.

Caution:

1. The filter must be in place, or it may lead to leakage.

2. Place a container under the drain pump filter, to collect any excess water that may come out of the drain pump when the filter is removed.

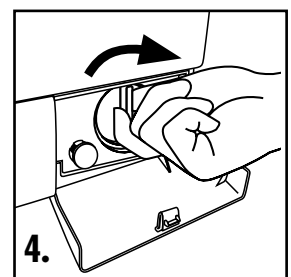
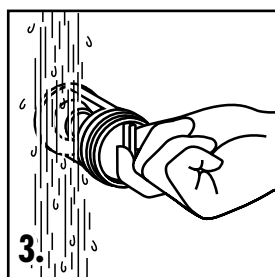
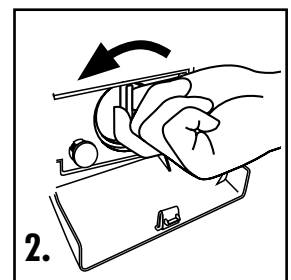
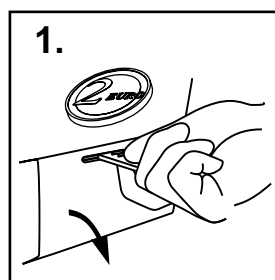

WATER INLET VALVE AND INLET VALVE FILTER

To prevent blockage to the water supply by ingress of foreign substances, clean the water inlet valve and inlet valve filter regularly.

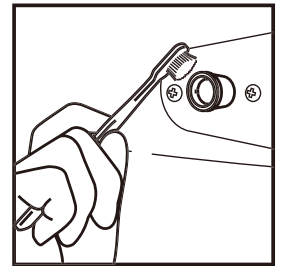

MOVING THE MACHINE

If the machine is to be moved to a distant location, replace the transportation bolts removed before installation to prevent damage as shown below.

1. Remove the back cover.
2. Remove the blanking plugs.
3. Insert the synthetic stabilisers and the transportation bolts.
4. Tighten the bolts with a spanner.
5. Replace the back cover.

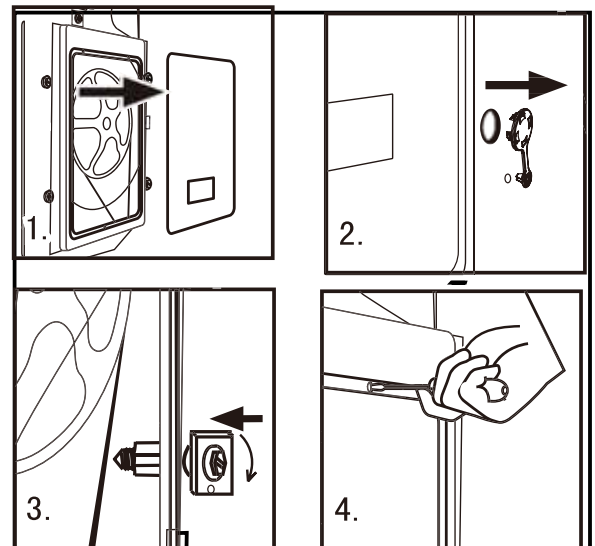

LONG PERIODS OF DISUSE

If the washing machine is left idle for a long period, pull out the electrical plug and turn off the water supply. Open the washer door to prevent formation of moisture and odours. Let the door open while not used.



18 MAINTENANCE

DISPLAY CODES

DISPLAY CODES AND SPECIAL FUNCTIONS

CODES	CAUSES	SOLUTIONS
Err1	→ Door is not properly shut.	_ Shut the door properly, and then press the Start/Pause button.
Err2	→ Drainage error, water not emptied within 6 minutes.	_ Clean the filter and check the drain hose for blockage. If error still exists, please contact the maintenance personnel.
Err3	→ Temperature sensor not properly connected or damaged.	_ Contact the maintenance personnel.
Err4	→ Heater error (Appears at the end of a cycle).	_ Contact the maintenance personnel.
Err5	→ Water level not met in 8 minutes. → The height of the drain hose is below 80 cm. → The drain hose is in water.	_ Make sure that tap is turned on, and water pressure is normal. If problem still exists, please contact the maintenance personnel. _ Install drain hose within 80-100 cm of height. _ Make sure the drain hose is not in water.
Err7	→ Motor error.	_ Contact the maintenance personnel.
Err8	→ Water exceeds protective level.	_ Contact the maintenance personnel.
Er10	→ The signal of Water level sensor is wrong.	_ Contact the maintenance personnel.
EuAr	→ The driving computer and the computer board of display can't communicate.	_ Contact the maintenance personnel.

Note: When the above error code displays, we suggest switch off the power and restart the machine to operate again. If error still exists, please contact the maintenance personnel.

End → End of wash cycle.

UNb After the last rinsing cycle finishes, spinning fails completely due to unbalance of the laundry.

→ Control panel lock function: Press the "Delay" and the "Start/Pause" buttons simultaneously for 3 seconds after starting a program. It can no longer be changed by operating buttons or knobs. To unlock press the "Delay" and "Start/Pause" buttons again for 3 seconds.

→ Power-off memory function: In case of abrupt power failure or the need to cut off the power during a program cycle, the present settings will be saved and the preset operation will resume when the power is on again.

→ To cancel a program

Press the "Start/Pause" button, then switch off the power and the program is automatically cancelled. Turn the program selector again to choose another program.

Note: During the spin process, if too much foam is inspected, in order to protect the motor, the washing machine will eliminate the foam automatically; the motor will stop and the drain pump will drain the water continuously for 90 seconds. If it happens more than 3 times, the motor will stop until the end of cycle without spinning.

TROUBLESHOOTING

TROUBLESHOOTING

The following circumstances do not constitute problems. Do not contact the Service Center until the problem has been confirmed.

PROBLEM	CAUSES	SOLUTIONS
Washing machine fails to operate.	<ul style="list-style-type: none"> → Poor connection to the power supply. → Power failure. → The washer door is not properly closed. → Machine has not been switched on. 	<ul style="list-style-type: none"> _ Check connection to the power supply. _ Check the power supply. _ Close the washer door properly. _ Make sure the machine is switched on.
Washing machine cannot be filled with water.	<ul style="list-style-type: none"> → The "Start/Pause" button is not pressed. → Water tap is not turned on. → Water pressure is less than 0,03 Mpa. → The inlet hose is kinked. → Water supply failure. → The program knob is not properly set. → The washer door is not properly closed. → The inlet hose filter is blocked. 	<ul style="list-style-type: none"> _ press the "Start/Pause" button. _ Turn on the water tap. _ Check water pressure. _ Check the inlet hose. _ Ensure the water supply. _ Set the program knob properly. _ Close the washer door properly. _ Unblock the inlet hose filter.
Machine is draining while being filled.	<ul style="list-style-type: none"> → The height of the drain hose is below 80 cm. → The drain hose is in water. 	<ul style="list-style-type: none"> _ Install drain hose within 80-100 cm of height. _ Make sure the drain hose is not in water.
Drainage failure.	<ul style="list-style-type: none"> → Drain hose is blocked. → Drain hose end is higher than 100 cm above the floor level. → The filter is blocked. 	<ul style="list-style-type: none"> _ Unblock the drain hose. _ Make sure the drain hose end is lower than 100 cm above floor level. _ Unblock the filter.
Strong vibration while spinning.	<ul style="list-style-type: none"> → Not all transportation bolts have been removed. → Washing machine is located on an uneven surface or is not level. → Machine load is over Max load. 	<ul style="list-style-type: none"> _ Remove all transportation bolts. _ Make sure the washing machine is on an even surface and levelled. _ Reduce amount of laundry in the drum.
Operation stops before completing wash cycle.	<ul style="list-style-type: none"> → Water or electricity failure. 	<ul style="list-style-type: none"> _ Check the power supply.
Operation stops for a period of time.	<ul style="list-style-type: none"> → Washing machine gives an error message. → Washing machine is in soaking cycle? 	<ul style="list-style-type: none"> _ Check display codes. _ Press the rinse hood button or the Start/pause button again to cancel it.
Excessive foam in the drum, which is spilled to the distribution drawer.	<ul style="list-style-type: none"> → The detergent is not a low-foaming type or for manual wash. → Excessive use of detergent. 	<ul style="list-style-type: none"> _ Check if your detergent is appropriate. _ Reduce amount of detergent in the distribution drawer.
Automatic adjustment of the washing time.	<ul style="list-style-type: none"> → The washing program duration will be adjusted 	<ul style="list-style-type: none"> _ This is normal and doesn't affect the functionality.
Spinning fails	<ul style="list-style-type: none"> → Unbalance of the laundry 	<ul style="list-style-type: none"> _ Add clothes or run a spinning program again.

Haier

Haier Deutschland GmbH
Hewlett-Packard-Straße 4
D-61352 Bad Homburg

Tel.: +49 (0)6172 / 94 54 - 0
Fax: +49 (0)6172 / 94 54 - 499
Mail: info-de@haiereurope.com

Free Manuals Download Website

<http://myh66.com>

<http://usermanuals.us>

<http://www.somanuals.com>

<http://www.4manuals.cc>

<http://www.manual-lib.com>

<http://www.404manual.com>

<http://www.luxmanual.com>

<http://aubethermostatmanual.com>

Golf course search by state

<http://golfingnear.com>

Email search by domain

<http://emailbydomain.com>

Auto manuals search

<http://auto.somanuals.com>

TV manuals search

<http://tv.somanuals.com>