

DWE-3120A

Computerized Full-auto Washing Machine



- Please read this manual carefully before using.
- Retain it for future reference
- Please check if the power receptacle has good earthing condition before using to guarantee your safety.
- The manufacturer will not bear the responsibility for those risks occurred from not obeying this manual.

Contents

Before using

Names of the parts.....	The 2nd cover
Safety precautions.....	1
Ins Tallation and adjustment.....	3
Install the water inlet hose.....	5

Using Process

Preparation before washing.....	7
Put in the laundries.....	8
Usage of the detergent.....	9
Use the operation buttons.....	10
Close the top lid.....	14
Finish washing.....	14
Disposal after washing.....	15
Trouble shooting*answer to question.....	16

Packing list.....	17
--------------------------	-----------

Specification table	The back cover
----------------------------	-----------------------

Names of the parts

Before Using

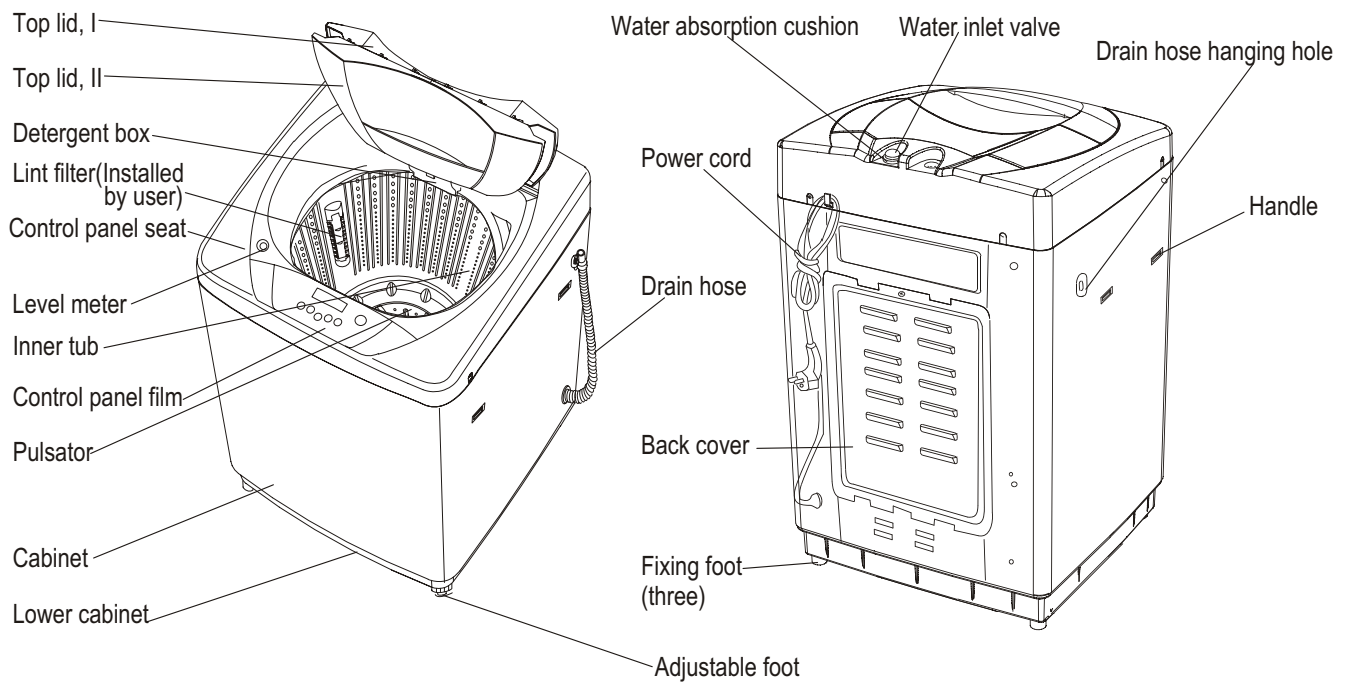

Accessories

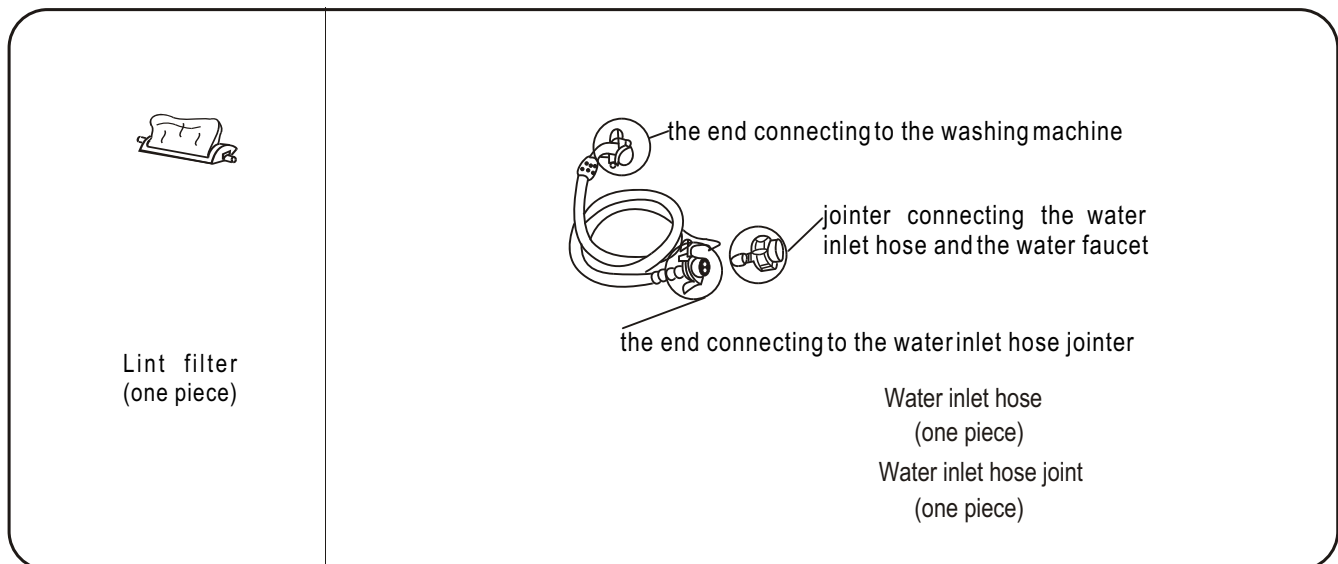

Meaning and description of the symbols



Contents marked with that symbol are related to the safety of the product and the personal safety of the users. Please operate in strict conformity to the contents, otherwise it may result in damage of the machine or influence the personal safety of the users.



Contents marked with that symbol are actions forbidden to perform. Performing of those actions may result in damage of the machine or influence the personal safety of the users.

Safety precautions

Before Using

Please plug the power plug on special receptacle. Be sure to use three-pins power receptacle. Ensure that the earthing prong of the power receptacle is earthed reliably. Use leakage protector if possible.

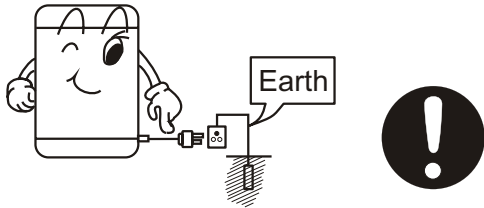

In normal usage of the washing machine, the power plug shall be ready to be pulled or plugged with hand. Be sure to pull the plug off and close the water faucet in following cases: power failure, delivering the machine, setting the machine idle or cleaning the machine. Do not plug or pull the power plug with wet hand.

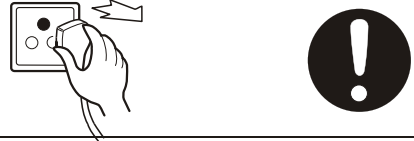

Do not bend, stretch, twist, bind the power cord by force, or reform it. Do not press or clamp it with heavy items. If the power cord and power plug are bad, or the receptacle is loose, be sure to have it replaced by the technicians of our special shop or our agent, or the after-sales service department for the sake of avoiding any risk. Keep the prong of the power plug clean. If dust is found on the power plug, please wipe it off with dry cloth.



Do not put the machine at damp place like the bathroom. Never wash it with water.

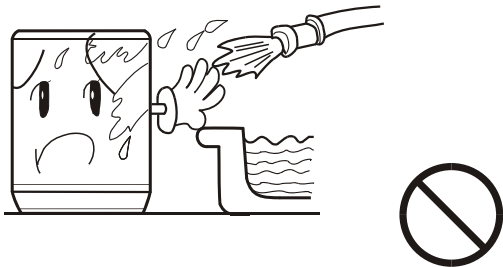

Do not use water hotter than 50°C .



In case the washing machine is installed on ground with carpet, do not block the ventilation hole with carpet.

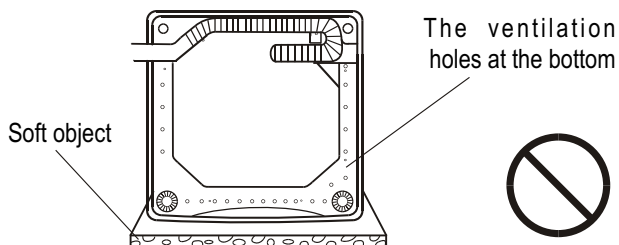

Do not wash water-proof laundries like the raincoat, bike covers etc. to avoid abnormal vibrations in spinning.



Do not let the machine share one receptacle with other electric appliances. If the power plug is damaged, or the plugging into the receptacle is loose, do not use the plug any more.



Safety precautions

Before Using

Do not stretch hands into the working machine. It is dangerous even if the rotation is slow. Take special care of the children.

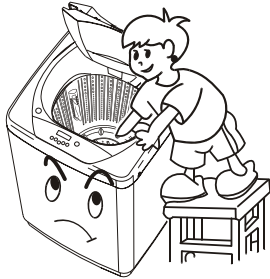

Do not decompose, repair or alter the machine by yourself.



Do not put any hot or heavy items (such as the kettle with hot water) on the washing machine



Do not wash laundries with volatile materials (such as thinner, petrol etc.).

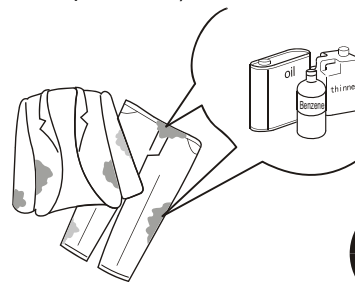

The handicapped or children without care shall not use the machine..

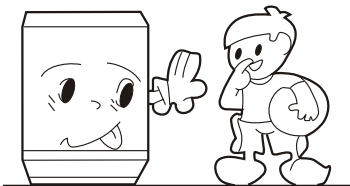

Keep the machine away from direct sunlight and heat source like the heater.

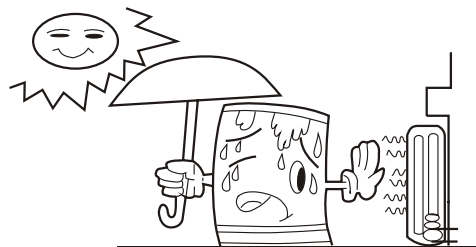

The lint filter shall be kept in good condition, and installed to proper position. If the lint filter is lost or damaged, please contact the local after-sales service department of our company.



Installation and adjustment

Before Using

Please install and adjust the machine according to the requirement of the manual. It is very important to your security and correct operating the machine.

Install the lint filter

After opening the package, please take out the lint filter from the document bag and install it into the Filter frame of the inner tub. See to the right Figure.

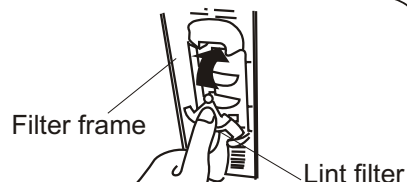

Adjust the Installation position

The largest allowed slope of the shank base of the machine is 2° . The slanting or rough ground will result in unstable running or stoppage of the machine. Please adjust it with following methods:

- Confirm it's horizontal
Hang the plumb to confirm it's horizontal

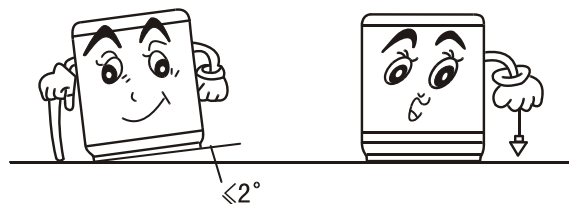

- Confirm it's horizontal:
If the bulb of the level meter at the balance display position is inside the standard circle, it indicates that the machine is horizontal. Otherwise you need to adjust the adjustable leg of the machine.

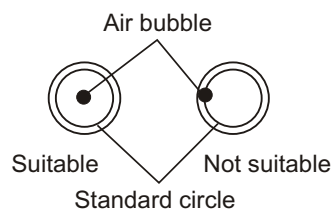

- Adjust the adjustable foot
 - (1) To twist the adjustable foot at the right front of the cabinet (front the sight of front), please first lift up the side of the foot slightly, loosen the adjustable nut, and twist the foot.
 - (2) Fasten the nut after adjustment.

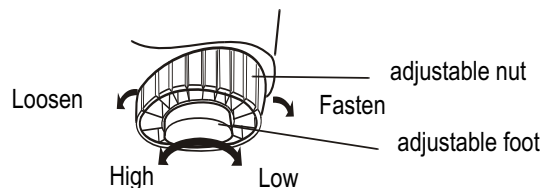

Before Using

How to change the direction of the drain hose

1. Lean the machine down gently with the front surface facing the ground.

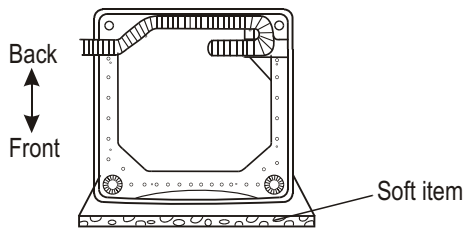

3. Extend the drain hose from the left side. Push the drain hose into the groove with hands.

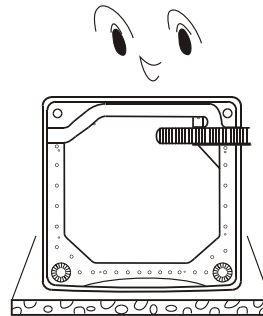

2. Pull out the drain hose from the groove at the left side.

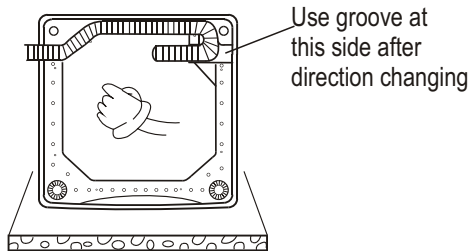

Usage of the drain hose

The drain hose shall drain smoothly

1. The height of the drain hose shall be less than 10cm, or the drainage will not be smooth, and cost such long time that the machine may stop at mid way.

2. Do not ramp or press the drain hose.

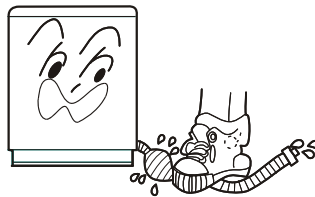
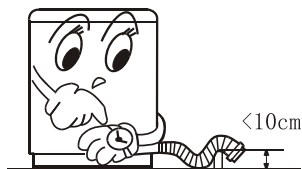

4. If extra drain hose is needed, please make separate purchase. The inner diameter of the extra hose shall not less than 30mm, and the length shall not exceed 1.5m.

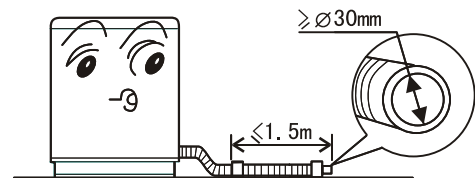

3. If the drain hose is too long, cut it at mid point. To make smooth drainage, cut the front end of the hose slantingly.

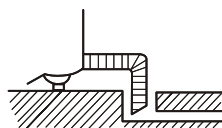
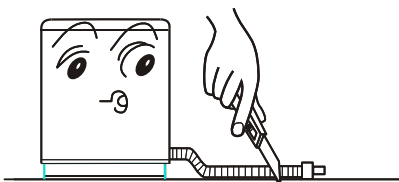

5. If the extra hose is too long, cut it either at A or at B point.

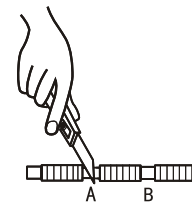

Install the water inlet hose

Before Using

Confirm the water faucet

water faucet, suitable



The exit end face of the faucet

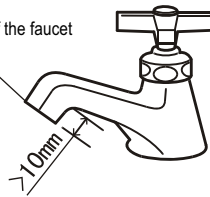

water faucet, not suitable

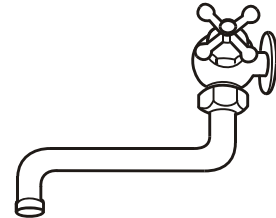

It is required that the front end shall be longer than 10mm.

The exit end face of the faucet shall be flat and smooth. If not please file it to avoid leakage.

Connection between the water inlet hose jointer and the water faucet

1. Press the lower end of the lock lever and push down the slider. Take off the water inlet hose jointer from the water inlet hose component. See to Figure 1.
- 2 Loosen the screw till the water faucet can be accessed. Put the jointer of the water inlet hose on the faucet. See to Figure 2. (If the faucet is too large and the jointer can not be set on the water faucet, please loosen the four screws and take out the bushing in the jointer. The front end of the faucet must be smooth, otherwise it may leak water. See to Figure 3.)

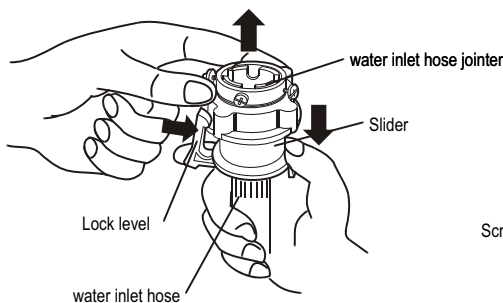

Figure 1

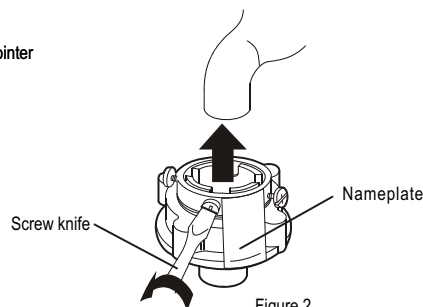

Figure 2

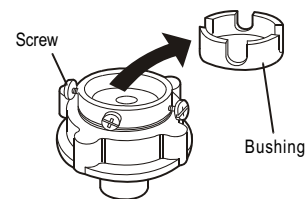

Figure 3

3. Fasten the four screws evenly. See to Figure 4.
- 4 Take off the nameplate. Twist the fastening nut as per the indication of the figure to seal up the exit end face of the faucet. See to Figure 5.

Remark: .Before twisting the fastening nut, the threading is 4mm above the upper surface of the nut. After twisting, the threading is less than 2mm above the upper surface of the nut. See to Figure 6

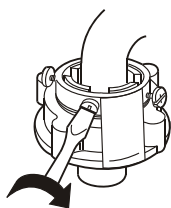

Figure 4

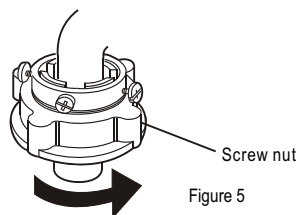

Figure 5

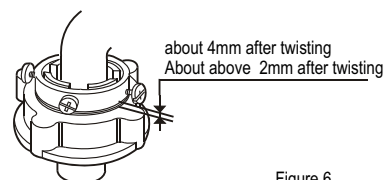
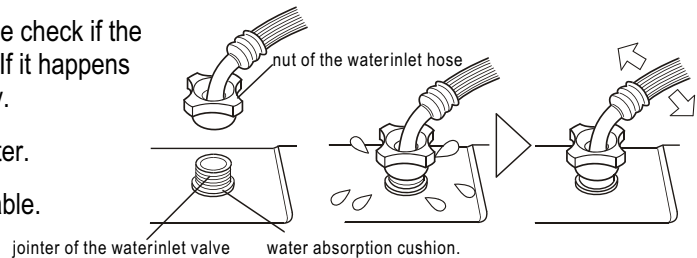

Figure 6

Connection between the water inlet hose and the washer

1. Do not take off the water absorption cushion. Please check if the cushion is dropped or damaged before each usage. If it happens please contact our after-sale department immediately.
2. Put the nut of the water inlet hose on the valve jointer.
3. Fasten the nut. Swing it gently to confirm if it's suitable.



Connection between the jointer of the water inlet hose and the water inlet hose

1. Push down the slider. Insert the water inlet hose into the jointer.
2. Hang the lock lever to the jointer. Release the slider till a click sound is heard.

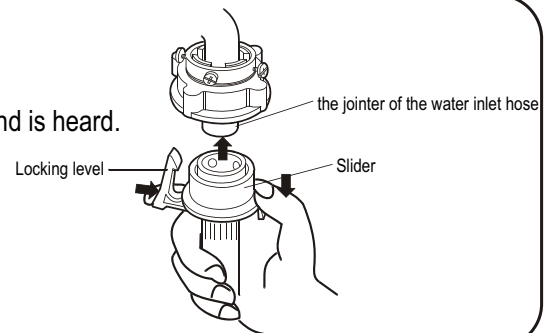

Check the connection between the jointer of the water inlet hose and the water faucet

1. Swing the hose gently to confirm if it is fastened stable.
2. After installation, open the faucet to check if it leaks.
3. Do not bend the hose with overstrain.
4. Before each usage please check if the connection between the jointer of the water inlet hose and the water faucet, and the installation of the water inlet hose are firm, so as to prevent dropping from improper installation position.

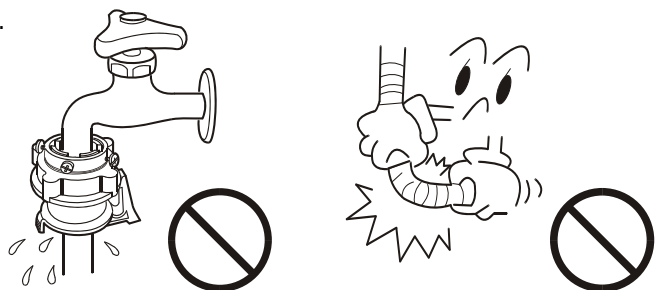

Dismantle the water inlet hose

1. Close the water faucet.
2. Press the locking lever. Push down the slider. Then pull off the water inlet hose. If the machine is used frequently, the jointer of the water inlet hose can be kept on the faucet to prevent damaging the fixing screw.

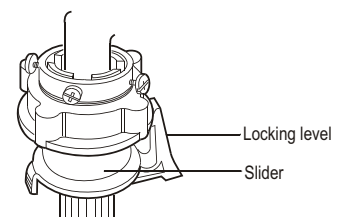

1 Preparation before washing

Using process



Preparation before washing

1. Connect the water inlet hose. Open the water faucet.
2. Confirm that the washing machine is earthed reliably. Then insert the power plug into the receptacle. The earth terminal shall not link to gas pipeline and faucet water pipeline.
3. Put down the drain hose.

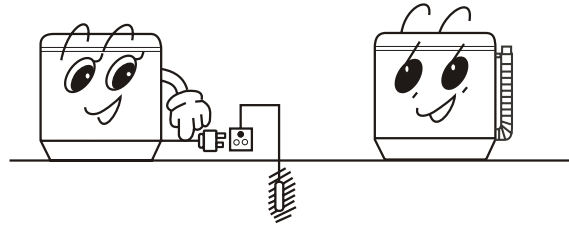

Pay attention to following before washing

Check if the laundries has special requirement on washing

Clear the pocket. Take out the coins, sand, hairpins etc.

Tie the long strips; fasten the buttons; close zippers.

The quantity of the laundries shall not be too large. Stretch and loosen the laundries before putting them in the tub.

When the pulsator is running, the buttons of the laundries may cause noise. For the sake of discretion, please put the laundries with buttons into other laundries.

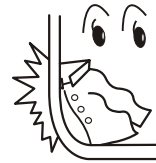

- a. Check if the laundries are applicable for washing with machine.
- b. Divide the laundries that are not colorfast from other laundries.
- c. Put those laundries difficult to absorb water into water with hand.
- d. For those laundries with heavy soil, please first remove the dirt like mud or dust. For the parts with heavy soil, please apply detergent on them in advance, which can make it easier to remove the soil.
- e. For those laundries that may get lint ball and those with long fur, turn it over before putting in.
- f. Do not put those laundries polluted by chemicals into the washing machine directly.

2 Put in the laundries

Using process



- The capacity of washing and spinning of the machine refer to the largest weight of the standard laundries under dry condition that can be washed or spinning in one time. One time washing quantity shall be lower than the rated capacity. The largest capacity of this machine is 12.0kg.
- The thickness, size, type of the cloth will influence the actual washing capacity. It is suitable for one time washing to put in reasonable amount of laundries and the laundries can be turned round in washing.
- Do not select above 8 water level for laundries small than 2.0kg, so as to avoid splashing of water.

Reference weight of the laundries:

- working suit (up,down) (cotton, about 1120g)
- blanket (cotton, about 900g)
- pajamas (about 200g)
- shirt (cotton, about 300g)
- undershirt (cotton, about 180g)
- jeans (about 800g)
- blending coat (about 800g)
- jacket (cotton, about 800g)
- single bed sheet (cotton, about 600g)
- underpants (cotton, about 70g)
- socking (blending, about 50g)

3 Usage of the detergent *Using process*

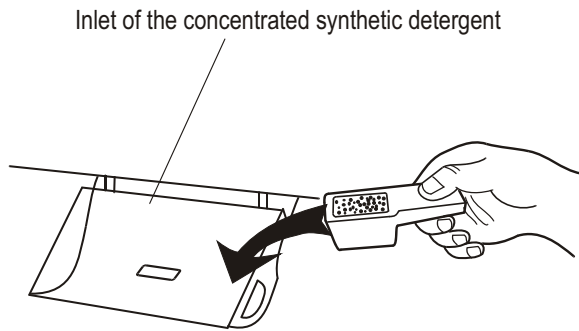

- First turn the detergent box down before adding detergent.
- Add the concentrated composite washing powder into the box directly as indicated in the left figure.
- See to following table for the dosage of the washing powder.

How to use the whitener

- Fill water to decided level .Dilute the whitener with container. Pour it slowly into the washing tub.
- Avoid using whitener on laundries with colour or pattern as they are prone to lose colour.
- The whitener shall not touch the laundries directly.
- Refer to the user's manual for the usage and quantity of the whitener.
- For powder whitener, please dissolve it before use.

How to use the washing powder

- Direct dissolved in the machine(not applicable for fuzzy and reserve programs)
 - 1.Fill small quantity of water.
 - 2.Add the power. Run for 30 seconds to dissolve it completely.
 - 3.Put in the laundries. Select suitable water level.
- The instant dissolving of the washing powder:
 1. Prepare warm water of 30°C and a container.
 2. Add the powder while stirring to fully dissolve it.
- Please according to the water level , water quantity and laundries quantity to select powder quantity properly.
- It is suggested not to use high sudsing detergent.
- Washing power with poor quality or not used for a long period may get blocked. Please clean the detergent box in time.

Water level , water quantity and selection of powder





Laundries quantity (kg)	Water level	Water quantity	Common powder, Add 40g in each 30L water	Concentrated powder, Add 25g in each 30L water
9.0 ~ 12.0	12	About 96L	▶	About 129g
	11	About 89L		About 119g
	10	About 83L		About 111g
6.0 ~ 9.0	9	About 77L	▶	About 103g
	8	About 71L		About 95g
2.5 ~ 6.0	7	About 65L	▶	About 87g
	6	About 59L		About 79g
1.0 ~ 2.5	5	About 53L	▶	About 71g
	4	About 47L		About 63g
Below 0.5	3	About 41L	▶	About 55g
	2	About 35L		About 47g
	1	About 29L	▶	About 39g

4 Use the operation knobs and buttons

Using process

a Description of the function of the knobs and buttons

Mode and meaning of the VFD indicator

-  The frame of indicator is not lighted.
-  the frame of the indicator is flashing : indicate the running program.
-  the frame of the indicator is on : indicate the program about to run, or indicate the selected mode
-  the frame of the indicator is flashing rapidly: indicate abnormal condition.

Digital tube

- During working , it displays the remained reserve time (minute).
- During reserve, it displays the remained reserve time (hour)
- In case of trouble, it displays the abnormal symbol(see to page 16)

RESERVE button

- During operation, the digital tube will display the remained time before finishing in minute.
- Push the reserve button. The digital tube will display the reserve time for finishing of washing in hour. The indicator will flash to indicate that the reserve function is working.

WATER LEVEL button

- You need to select the water level by yourself.
- If you put in wet laundries, you need to select suitable water level manually. Refer to **water level water quantity and selection of powder** in page 9. 
- In selecting the **quick wash** program, the water level is set to **2** automatically. When the **2** is reached, it will do washing while filling water. When **4** is reached, it will perform normal washing.
- Due to the variable cloth and humidity, the set water level may be different from the actual water level. Sometimes it may perform water adding.
- During washing, push the **water level** knob to add water.

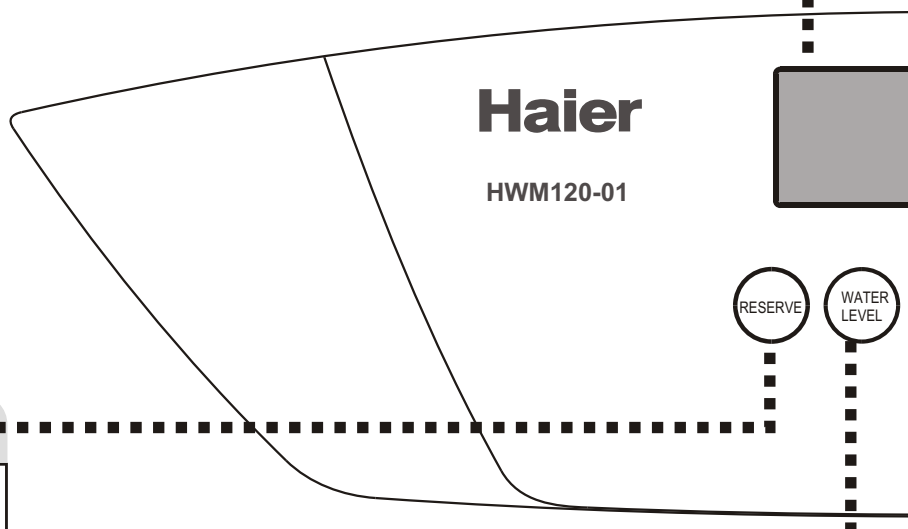

PROCESS button

- one or more one programs among **soak wash rinse spin** can be selected.

POWER ON/OFF button

- Push the "On/Off" button to switch on the power.
- When the power is on, push it again to switch off the power.
- After the power is switched on , if the washing machine is idle for 10 minutes, it will switch off the power automatically.

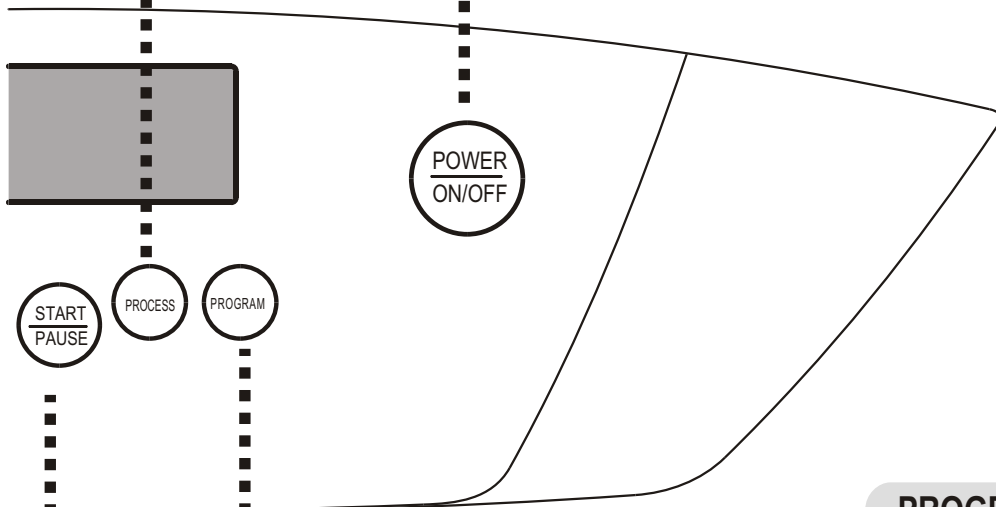

PROGRAM button

- The following four programs are available.

	Standard	Common washing
Programs	Jeans	Washing large , thicker , or heavily soiled laundries
	Gentle	Washing woolen textile or underwear
	Quick	15-minute quick wash for the laundries with under 3 kg

START/PAUSE button

After the power is switched on, push it to start the machine

- During working, push it to pause working.
- During pause, push it to resume working.

b Steps of using the operation buttons and description of the steps

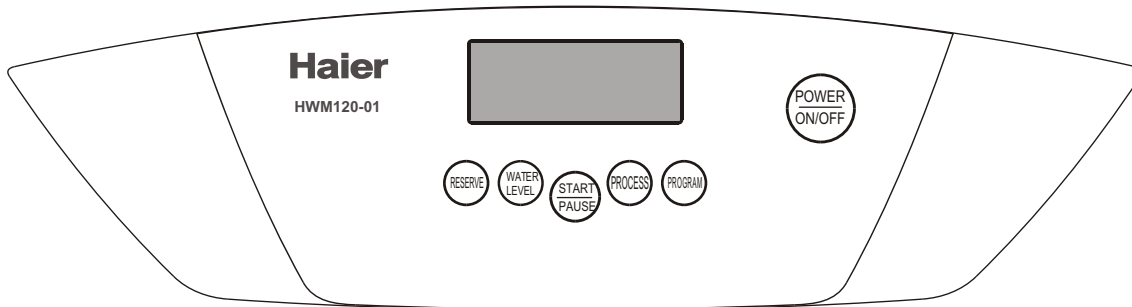

1 Push the **POWER ON/OFF** button to switch on the power.



2 Push the **PROGRAM** button to select the suitable automatic program.



After switching on the power, the machine will set to standard program automatically. To select other program, push the **PROGRAM** button till the corresponding indicator is on. Refer to the **PROGRAM** button in Page 11.

Page 11



For an example: select **quick wash** for the quick washing of the laundries with light dirt.

3 Push **PROCESS** button to select suitable procedure



After switching on the power, the machine will set to **WASH-RINSE-SPIN** program automatically. That is the most common program. To select other program, push the **PROCESS** button to select one or more procedures among **SOAK WASH RINSE SPIN**.

Refer to the **PROCESS METHOD** for the selection.

Page 9



Attention

- Even there's no water in the tub, the spinning will start after a certain period.
- Do not use the **SOAK** program for the woolen laundries.
- Wash the laundries that are prone to lose colors separately from other laundries.
- while washing soft laundries such as silk stockings and textile , please put into a wash net which can get by shopping.

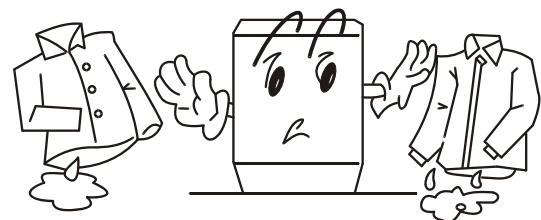

Selection method of the procedure programs

Times of pushing the PROCESS button	Selected procedure program	Applicable procedure	Contents (the lighted indicators indicate the programs about to run)
0	Wash, rinse, spin (standard program)	When the common laundries need washing , rinsing and spinning	<input type="checkbox"/> Soak <input checked="" type="checkbox"/> Wash <input checked="" type="checkbox"/> Rinse <input checked="" type="checkbox"/> Spin
1	Wash (the washing liquid remains in the tub)	Repeat using the washing liquid	<input type="checkbox"/> Soak <input checked="" type="checkbox"/> Wash <input type="checkbox"/> Rinse <input type="checkbox"/> Spin
2	Wash (the rinsing liquid remains in the tub)	Repeat using the rinsing liquid	<input type="checkbox"/> Soak <input checked="" type="checkbox"/> Wash <input checked="" type="checkbox"/> Rinse <input type="checkbox"/> Spin
3	Rinse, spin	When the laundries need rinsing and spinning after hand washing	<input type="checkbox"/> Soak <input type="checkbox"/> Wash <input checked="" type="checkbox"/> Rinse <input checked="" type="checkbox"/> Spin
4	Spin (spin after drain)	When the laundries only need spinning after hand washing(first spin then drain)	<input type="checkbox"/> Soak <input type="checkbox"/> Wash <input type="checkbox"/> Rinse <input checked="" type="checkbox"/> Spin
5	soak wash, rinse, spin	If the laundries are very dirty, or the sleeve and collar are dirty, first soak then wash	<input checked="" type="checkbox"/> Soak <input checked="" type="checkbox"/> Wash <input checked="" type="checkbox"/> Rinse <input checked="" type="checkbox"/> Spin

- If you push the **PROCESS** button for 6 times, it will resume the initial mode, and it will circulate in that way.
- The soak program can be used as fitting of the standard/jeans automatic programs. It will do soaking with intermittent stirring of pulsator.
- After the washing machine starts working, you can only make selection during wash , and cannot make selection during other procedures.

4 Push the **WATER LEVEL** button to selection suitable water level



When the power is switched on, you need to set the suitable water level by yourself. Refer to the **water level water quantity and selection of powder** in Page 9 and **water level** in Page 10 for the selection.



Time list of each program (minute)

Program	water level	Wash (min)	Rinse (min/time)	Spin (min)	Total time (min)
Standard	1~12	10~15	Rinse twice , each about 4	About 6	40~53
Jeans	1~12	10~15	Rinse with water inlet twice, each about 4	About 6	40~54
Gentle	1~12	About 3	Rinse twice , each about 4	About 2	About 24
Quick	About 4	About 3	Rinse once , each about 2	About 2	About 15

Using process

- * Total time: including the normal water filling time, drain time.
- * Spin time: the time from intermittent running to finishing.
- * The normal and **jeans** automatic programs can be fitted with **soak** procedure selection. After water inlet, it will first soak for 15-45 minutes, then do washing, rinsing and spinning.
- * If **quick** procedure is selected, the machine will set the complete washing program of water level, wash, rinse, spin automatically.

5 Push the **RESERVE** button to select the suitable reserve program

RESERVE



When the power is switch on, the **RESERVE** program is disabled automatically. If you need to finish the washing in reserved time, please push the reserve button to select suitable program. Refer to the **RESERVE** button in Page 10.

Page 10

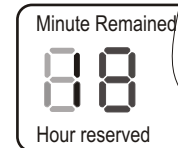

The washing will finish about 18 hours later.

- Confirm the reserve program
- When the reserve program is started, the digital tube will display the finishing time of the reserve washing.
- To change the running program or cancel reserve, you shall switch off the power and make new selection.
- The water inlet pressure and water level can influence the finishing time of washing.

6 Push the **START/PAUSE** button

START
PAUSE



5 close the lid

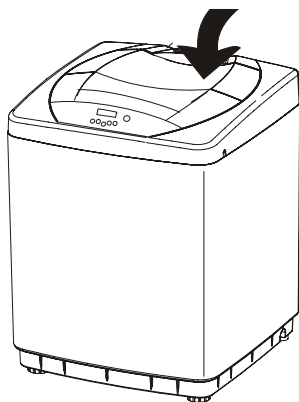

Excluding during soak, wash, filling water procedure, if you open the top lid, the machine will stop working and alarm before spinning.

6 finish washing



After Finishing wash alarm automatically

When the washing is finished, the power will be switched off automatically.

7 Disposal after washing

Using process

- After using, please clean the lint and foreign materials of the lint filter etc. in time. Otherwise it may influence your using the machine.
- Please first pull off the power plug from the receptacle before cleaning.

Clean the detergent box, then set it on the control panel seat

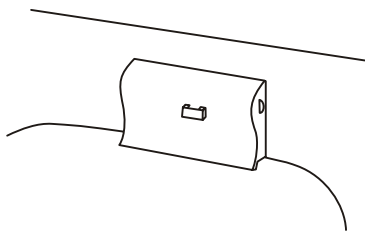

- The lint filter must be used during washing.
- It must be cleaned in time after each using

Lint filter:

1. Pull it up to dismantle.
2. Clean the filter screen after washing.
3. Push it down to install.

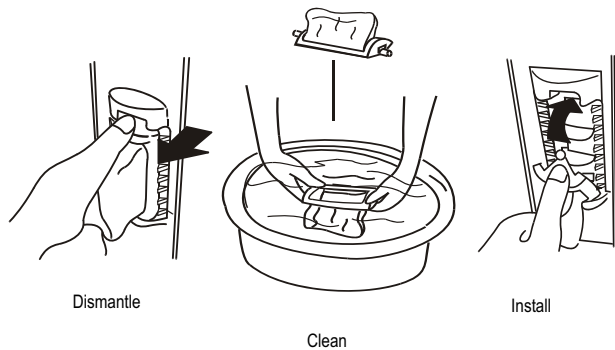

The filter screen of the water inlet valve is likely to be blocked by foreign materials and influence the water inlet. Please clean it with brush every two months.

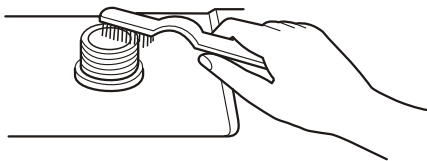

If the cabinet is dirty, wipe it with wet cloth

- Do not flush it directly with water.
- Wipe it with neutral detergent.
- Do not wipe it with thinner, petrol, alcohol etc.

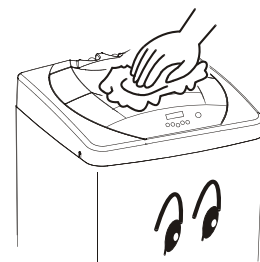

1. After washing, close the water faucet. (If needed, you can dismantle the water inlet hose).
2. Do not store water in the washing machine for a long period. Drain the water completely after each using.
3. Be sure to pull off the power plug before maintenance.
4. Hang up the power cord and drain hose.
5. Wipe off the water drops on the surface of the machine and inside the tub. Open the top lid for some time (about 1 hour), then close the top lid.

Trouble-shooting Answer to question

(If there's breakdown, please pull off the power plug before checking) The following phenomena are not breakdowns sometimes. Please confirm again before sending it to repair. If there are real breakdowns, please come to the special maintenance department or after-sale service department of our company. Do not repair it by yourself.

Phenomenan	The reason	How to settle
After the reserve is started, it rings and the digital tube displays E0	* The top lid is not closed.	* Close the top lid.
The draining does not work, or the speed of draining is too slow. The digital tube displays E1 and it rings.	* Is the drain hose put down? * Is the drain hose blocked by foreign material?	* Put down the drain hose. Open and close the top lid once. * Clean the foreign material. Open and close the top lid once.
It stops running during spin, the digital tube displays E2 and it rings.	* The top lid is not closed.	* Close the top lid.
The safety switch acts. The spinning can not work (after twice revising) The digital tube shows E3 and it rings.	* Are the laundries put slantingly? * Is the machine slanting?	* Re-order the laundries. Close the top lid. * Level the machine in right position. Open and close the top lid once.
It does not do water inlet or the speed is slow (the water level is not reached after 15 minutes). The digital tube displays E4 and it rings.	* Is the water faucet open or is there water supply failure? * Is the water inlet valve blocked.	* Open the water faucet. Open and close the top lid once. * Clean the water inlet valve. Open and close the top lid once.
the machine does not act. (The indicators are off.)	* Is there power failure? * Is the power plug loose?	* Use it when the power is on. * Insert the power plug tightly.
There's abnormal sound inside the machine.	* Is the machine slanting? * Is there metal material inside the washing machine? * Are the laundries slanting in spinning?	* Level the machine properly. * Fasten the fastener or zip up the zip. * Re-order the laundries. Close the top lid.
The water faucet leaks.	* Is the jointer screw of the water inlet hose loose or twisted awry?	* Fasten the jointer screw properly.

Common phenomena

Phenomena	Explanation
● The spinning is intermittent when it starts.	● Balance the laundries to avoid slanting.
● Push the PROCESS button to select SPIN , but it doesn't work.	● The program is setting the drain time. Some time is needed before it starts spinning.
● The pulsator pauses during water inlet in wash and rinse.	● It is to avoid splashing during water inlet.
● There may be some water flowing out of the drain hose in the first use of the machine.	● It is the water remained in the factory inspection of performance.

Packing list

Name	Quantity	Storage position
● User's manual	● One	● Inside the document bag
● Lint filter	● One	● Inside the document bag
● Components of the water inlet hose	● One	● Inside the accessory bag
● Computerized Automatic washing machine	● One	

Specification

Model	HWM120-01
Rated voltage • frequency	220V ~ • 50Hz
Rated washing / spinning capacity	12.0kg
Water level/Water quantity (about)	1/29L、 2/35L、 3/41L、 4/47L、 5/53L、 6/59L、 7/65L、 8/71L、 9/77L、 10/83L、 11/89L、 12/96L
Max water consumption	About 280L (Highest water level; Standard program)
Water Injection pressure	0.03MPa~0.78MPa
Rated washing input power	450W
Rated spinning input power	380W
Weight	About 60kg
Overall dimension	L 660 mm W 660mm H 1050 mm

Free Manuals Download Website

<http://myh66.com>

<http://usermanuals.us>

<http://www.somanuals.com>

<http://www.4manuals.cc>

<http://www.manual-lib.com>

<http://www.404manual.com>

<http://www.luxmanual.com>

<http://aubethermostatmanual.com>

Golf course search by state

<http://golfingnear.com>

Email search by domain

<http://emailbydomain.com>

Auto manuals search

<http://auto.somanuals.com>

TV manuals search

<http://tv.somanuals.com>