

Haier

HG1200TXVEME/HG1200TXVE
HG1000TXVEME/HG1000TXVE
HG800TXVEME/HG800TXVE

Automatic Drum Washing Machine

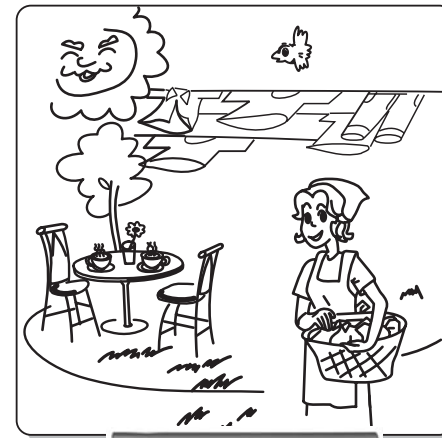

Table of Contents

Before using the appliance

Names of parts-----	inside front cover
Matters needing attention-----	1-3
Installation-----	4-5
Control Panel -----	6
Functions-----	6-7

How to operate the washing machine

Program description table-----	8
Preparation-----	9
Washing Procedure-----	10-11

Maintenance

Maintenance-----	12
Troubleshooting Guide-----	13
Technical Specifications-----	14
Wiring Circuit-----	15

Names of Parts

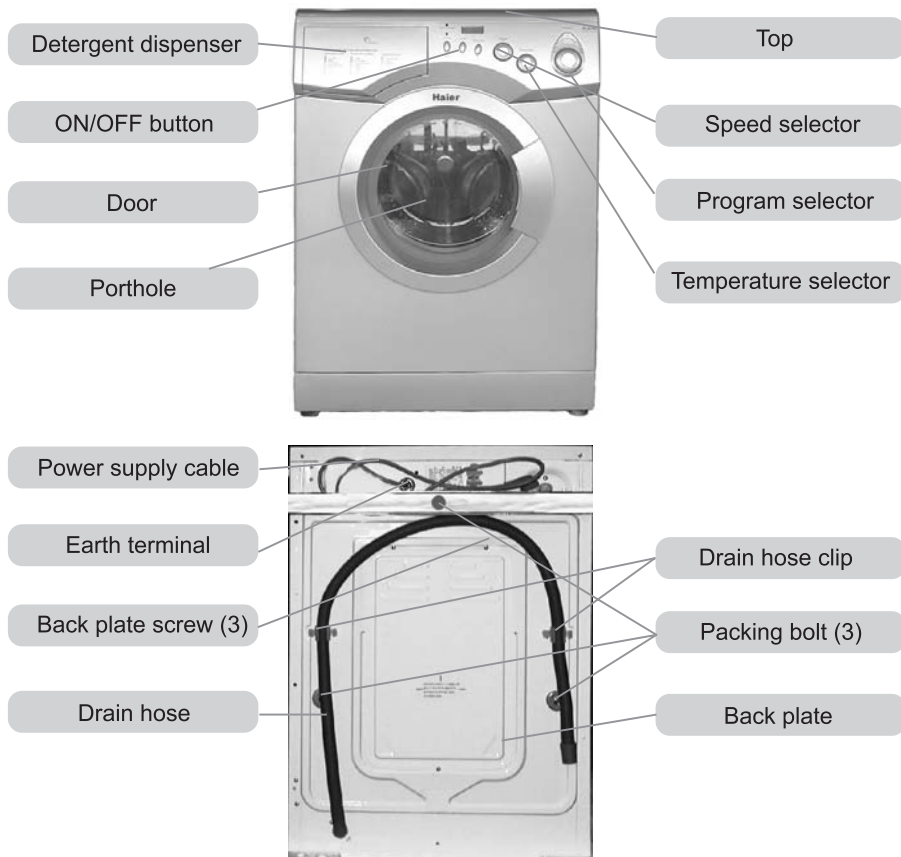

Caution and Warning symbols



For your safety, any instructions in this manual with this "Warning" sign must be followed strictly.







For your safety and to prevent damage to the washing machine, any instructions in this manual with this "Stop" sign must be followed strictly.

This diagram may be slightly different from the layout of the washing machine you have just purchased due to technical improvements.

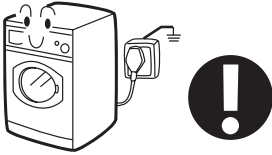
Matters Needing Attention

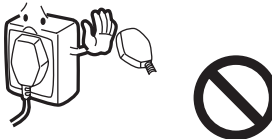
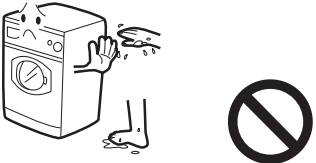
● Safety

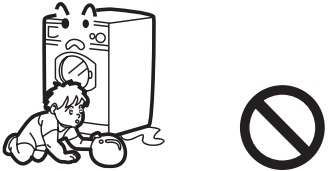
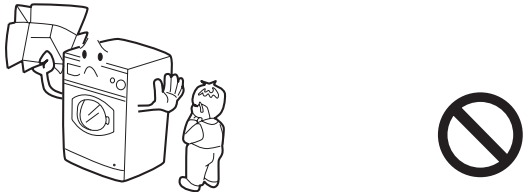
<p>1. A separate earthed socket is required for the power supply. After installation of the washing machine the power plug must be accessible during normal operation.</p> 	<p>2. Pull the plug and not the electric cable when unplugging the washing machine.</p> 
<p>3. Fuses in the power circuit should be rated for 15A. Contact a washing machine technician or a Haier designated service point for power cable replacement.</p> 	<p>4. For your safety, dry your hands before touching the washing machine and wear appropriate footwear.</p> 
<p>5. Do not use flammable detergents or dry cleaning agents; do not use flammable sprays near the washing machine; do not remove or insert the plug in the presence of flammable gas.</p> 	<p>6. The door of the washing machine becomes hot during the water heating process. Avoid contact with the door during the heating process. For safety, keep children away from the washing machine.</p> 
<p>7. Do not allow children to play with the packing materials after unpacking.</p> 	

Matters Needing Attention

8. The washing machine must not be used in the open or in an area of high humidity as water droplets may form on the electrical components. Air dry the appliance if the washing machine components become wet.



9. The washing machine should be placed in a well-ventilated area, leaving a space between the appliance and adjacent walls or furniture.

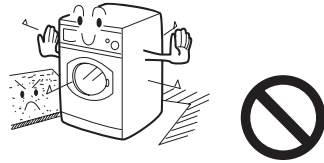

10. Keep away from heat sources and direct sunlight to prevent plastic and rubber components from ageing.



11. During installation, ensure that the electric cable is not trapped by the washing machine and damaged.

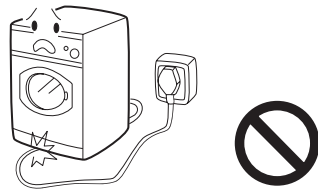

● Use

1. Make sure that the washing machine is securely connected to the water supply. Take the necessary precautions or contact the local service centre if the connection is poor or there is a water leak.



2. After turning the power off, turn the program knob clockwise to set the wash cycle.

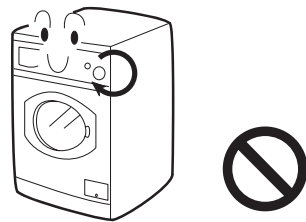

Wiring Circuit

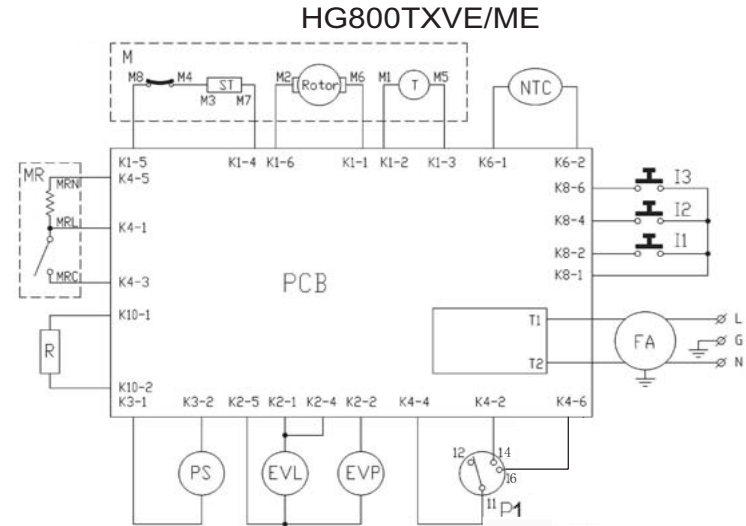

I1-Start/Pause

I2-Anti-crease soaking button

I3-Delay wash button

HG1000TXVE/ME HG1200TXVE/ME

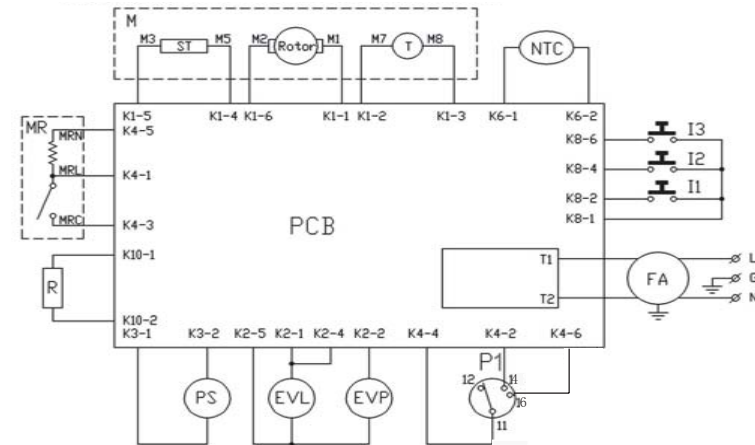

I1-Start/Pause







I2-Anti-crease soaking button

I3-Delay wash button

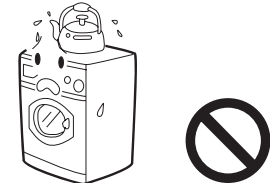
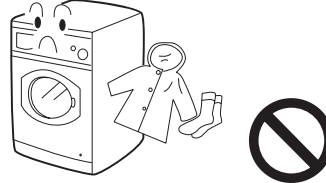
Technical Specifications

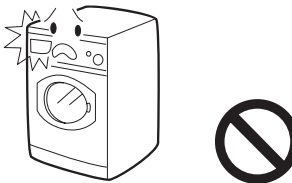
NAME	MODEL	HG1200TXVEME HG1200TXVE	HG1000TXVEME HG1000TXVE	HG800TXVEME HG800TXVE
Power supply		220V~230V/(50Hz)	220V~230V/(50Hz)	220V~230V/(50Hz)
Maximum working current(A)		10	10	10
Water pressure (MPa)		0.05 < P < 1	0.05 < P < 1	0.05 < P < 1
Washing power ()		300	250	250
Spinning power ()		700	530	500
Max. wash load (kg)		5	5	5
Spinning speed (MAX) (r/ min)		1200	1000	800
Wash program		15	15	15
Heating power ()		1800	1800	1800
Weight (kg)		86	86	86

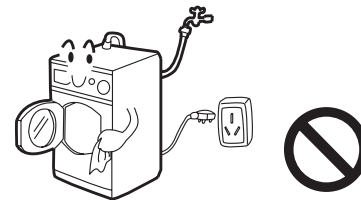
Matters Needing Attention

<p>3. Never place heavy objects, e.g. a heating appliance or water container, on the top panel of the washing machine.</p> 	<p>4. Do not wash foam rubber or similar sponge materials.</p> 
<p>5. Before washing, close zippers, buttons, laces and repair damaged areas. Underwear and small items should be placed in a laundry bag or pillow slip. Do not wash clothes containing wire frames.</p> 	<p>6. Do not open the detergent dispenser during the wash cycle.</p> 
<p>7. The door is fitted with a self-locking device and will only open 2-3 minutes after the washing machine stops. Do not force the door open. Do not open the door when the water level reaches the porthole.</p> 	<p>8. After washing, turn off the tap to prevent leaking; unplug the washing machine and wipe clean the lower part of the porthole.</p> 
<p>9. Keep the door slightly open when the washing machine is not being used. Never cover the machine with a plastic sheet.</p> 	

Installation

- As shown in figure 1 remove all the packing materials(including the foam base).

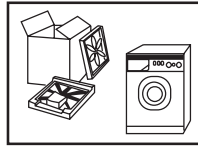

Fig.1

- Check attachments and materials

Name	Qty	Operational manual	Quality certificate	Water hose	Drain holder	Plastic plugs
HG1200TXVEME/HG1200TXVE HG1000TXVEME/HG1000TXVE HG800TXVEME/HG800TXVE		1	1	1	1	3

- Remove the packing screws as shown in figure 2.

The packing bolts protect the appliance from impact damage during transportation. Follow the steps below before using the appliance.

- Remove the rear panel of the washing machine;
- remove the three packing bolts from the rear panel of the washing machine, the rubber hose and then the shock absorption steel channel;
- refit the back plate;
- fill the holes left by the packing bolts with plastic plugs.

(Attention: the packing bolts and rubber hose should be kept in a safe place for later use)

★There is a plastic jacket packing the door catch, please remove it when you unpack the machine. Don't let children touch it to avoid dangerous things.

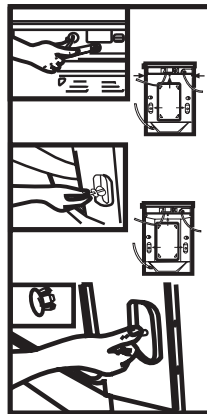

Fig.2

- Adjusting the position of the washing machine.

The washing machine is provided with adjustable feet. Before use, adjust the feet until the appliance is level, as shown in figure 3.

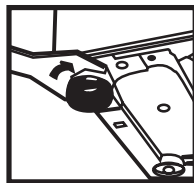

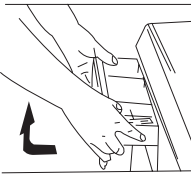
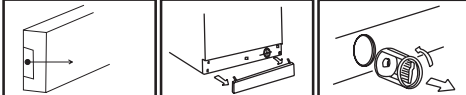

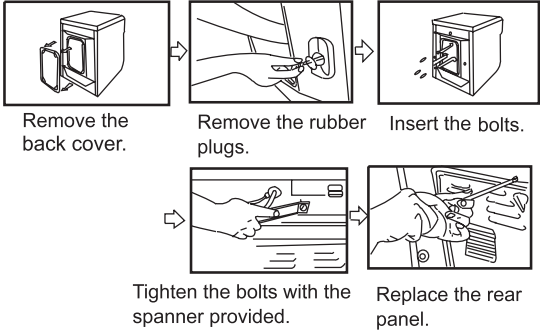

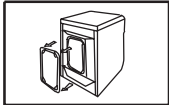
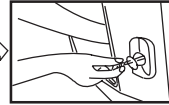
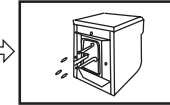
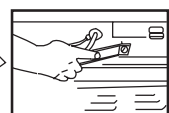

Fig.3

Trouble shooting

The following circumstances do not constitute problems. Do not contact the maintenance service until the problem has been confirmed.

Problem	Possible Cause
The washing machine fails to operate	<ul style="list-style-type: none"> Poor connection to power supply Power failure Door is not properly closed Machine has not been switched on
Washing machine does not fill with water	<ul style="list-style-type: none"> Water is not turned on Water pressure is less than 0.05MPa The inlet hose is kinked Water supply failure The program knob is not properly set The door is not properly closed
The water supply and drainage do not stop	<ul style="list-style-type: none"> Check that the height of the water hose is below 80cm
Drainage failure	<ul style="list-style-type: none"> Drainage hose is blocked Drainage hose end is below 100cm above the floor level
Strong vibration during spin	<ul style="list-style-type: none"> Some packing fixing bolts removed Washing machine on a uneven surface
Operation stops before completion of the wash cycle	<ul style="list-style-type: none"> Water or electricity failure
Excessive foam in the drum	<ul style="list-style-type: none"> The detergent is not a low foam type Excessive detergent has been used

Maintenance

<p>1. Turn of the water and electricity supply after every wash. Open the door to prevent the formation of moisture and odors. If the washing machine is left idle for a long period, drain any remaining water in the machine and replace the drainage hose.</p>	<p>2. Unplug the machine during cleaning and maintenance. Use a soft cloth dampened with soapy Liquid to clean the machine case and rubber components. Do not use corrosive or abrasive chemicals or solvents.</p>
<p>3. Clean the detergent compartment regularly. For the detergent compartment similar to figure (a), raise the compartment slightly to remove and replace after cleaning.</p>  <p>Fig.(a)</p>	<p>4. Cleaning the Filter (once a month). Press the lower edge of the filter compartment Cover to open; (Fig.1-2); Remove the filter by Turning counterclockwise; (Fig.3); Flash clean with running water; Filter replacement is the reverse of removal. Caution: Attention shall be paid to ensure that the filter is replaced correctly to avoid possible leakage.</p>    <p>Fig. 1 Fig. 2 Fig. 3</p>
<p>5. To prevent blockages to the water supply or the ingress of contaminants, clean the water inlet and inlet water filter regularly.</p> 	<p>6. If the machine is to be moved a distance location, replace the vibration mounting locks which were removed during installation as shown below.</p>  <p>Remove the back cover.</p>  <p>Remove the rubber plugs.</p>  <p>Insert the bolts.</p>  <p>Tighten the bolts with the spanner provided.</p>  <p>Replace the rear panel.</p>
<p>7. If the washing machine is left idle for a long period turn off the water and electricity supply and open the door slightly to prevent the formation of moisture and odors.</p>	

Installation

Connection of water inlet hose and washing machine

1. Place the water inlet hose nut on the connector of the water inlet valve.

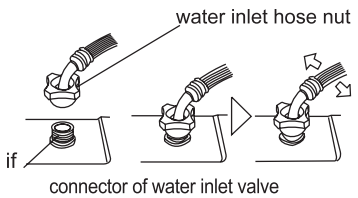

2. slightly shake the water inlet hose nut to see if it is tightly and properly fixed.

Water drainage hose

- The height of the terminal of the water drainage hose should be between 80cm-100cm, the water drainage hose must be securely placed on the clip on the back of the washing machine.

- Use the water drainage support supplied as an accessory for proper installation of the water drainage hose .fix the water drainage hose support with waterproof string. Do not use an excessively long water drainage hose and contract the authorized technician if the water drainage hose needs to be extended.the water drainage hose should not be extended more than250cm.(longer extension will result in concurrent water inflow and outflow).The diameter of the extension hose should be the same as the original hose.

caution:water drainage hose must not be immersed in water.the original and extension hoses should be tightly connected.

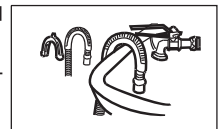
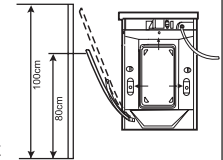





Connection of power supply

Check the following items before connection to the power supply.

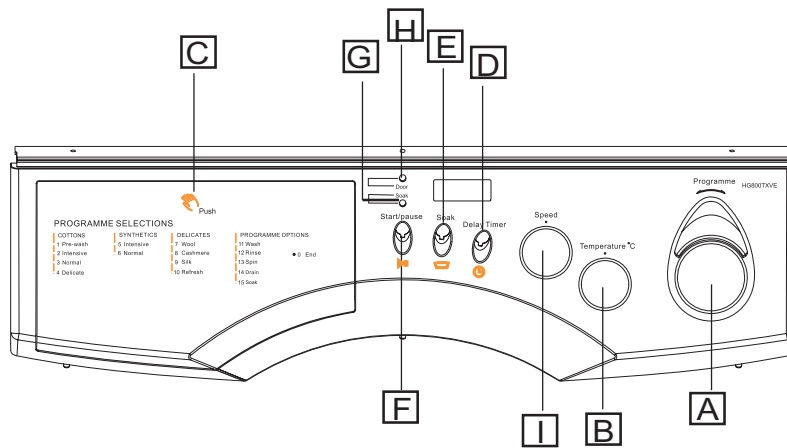
- The socket conforms to the maximum power load (The maximum current load of the socket and power supply cable should not be less than 15A).
 - power supply voltage conforms to the required value.
 - The power supply socket and the plug of the washing machine compatible, if they are compatible, Refer to a washing machine technician or a Haier designated service point for power cable replacement. The washing machine Should be connected to the earth before use.
 - Supplementary earth cable should not be necessary if the socket is connected to the earth.
 - Supplementary earth cable should be installed on the upper back of the washing machine and connected to an earth if the power supply socket has no earth connection.
- Caution: the supplementary earth cable should not be connected to water or heating pipes.

Control panel



<p>A Wash program knob By turning this knob, the required program can be selected. (Refer to the Guide to Operational Program Selection).</p> <p>Caution: The program knob is at the same time a power button. When the knob is set to Stop, the power is turned off; when the knob is set to other positions, the power is turned on.</p>	
<p>B Wash temperature knob</p> <p>By turning this knob, the required temperature can be selected (temperatures between 30°C-90°C can be selected). Refer to the Guide to Operational Program Selection.</p>	
<p>C Speed knob</p> <p>By turning this knob, the required spinning speed can be selected. The maximum speed will vary when a different program is selected.</p>	

Washing Methods

<p>4. Washing temperature setting</p> <p>Set the washing temperature as required, Maximum temperature for each program is displayed in the section setting</p>
<p>5. Spinning speed setting</p> <p>Turn this knob to select a suitable speed according to different needs.</p>
<p>6. Selecting the function button</p> <p>Select function buttons as required (refer to the Directions printed on the Operation panel), otherwise keep all the buttons released.</p>
<p>7. Washing</p> <p>Press the power button and the washing machine will automatically commence the programmed washing process.</p>
<p>8. End</p> <p>Wait 2-3 minutes after the washing process is finished. Press the power button again to cut off the power supply. Open the door to take out the laundry. Turn off the tap and unplug the washing machine.</p>
<p>Additional information</p> <p>Energy and water saving during wash process</p> <ol style="list-style-type: none"> 1. Collect clothes for one full wash load. 2. Do not overload the washing machine. 3. Pre-wash heavily soiled clothes. 4. Reduce the amount of detergent or choose fast or minimal washing programs for lightly soiled clothes. 5. Choose a proper washing temperature. Only exceed 60°C for heavily soiled clothes. 6. Do not use more detergent than required. 7. Softening agent makes clothes feel softer and easier to iron.

Washing Methods

1. Laundry loading

Evenly load the laundry in the washing machine and then tightly close the door of the washing machine

Note: 1) When first using the washing machine, let it run unloaded for one program to prevent the laundry from being tainted by oil or dirty water from the washing machine. 2) Do not overload the washing machine.

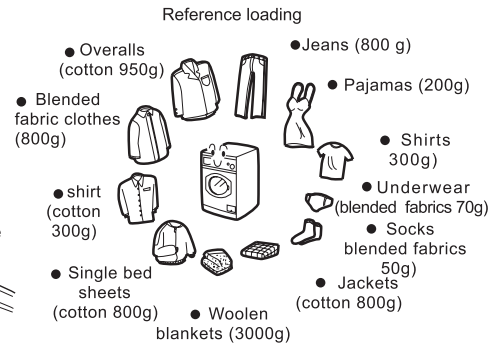

2. Use of detergent

Pull out the detergent drawer, put required detergent, softening agent and bleaching agent into the corresponding boxes. Push back the drawer gently.

- Caution: 1) Do not add liquid detergent into box 1 and 2
 2) For pre-washing program, detergent should be added to both box 1 and 2; for other programs, do not add detergent to box 1
 3) Do not overuse softening agent as this may damage artificial fabrics.

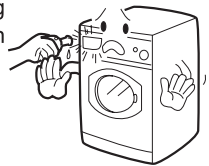

3. Washing program setting

Set the wash program correctly in accordance with the laundry load. The methods for setting wash programs are indicated on the handle of the distributor on the washing machine. Turn the program knob clockwise to the desired program.

Caution: Turn off the power before setting the wash program.

Control pannel

D Detergent distribution drawer

Instructions are printed on the handle of the drawer. Open the drawer, three compartments can be seen:
 Compartment 1: Pre-wash detergent
 Compartment 2: Normal wash Super quick wash detergent
 Compartment 3: Softener, conditioning agent, perfume, etc.

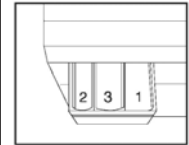

Fig. A

E Door lock indicator

When the light is on, the door is locked.

F Soaking indicator

When this light is on, the washer is in a soaking cycle. If the anti-crease button is pressed and a soaking cycle is started, this light will blink and the time reading on the screen will stop changing.

G Start / Pause button

When the washing machine is connected to the power, and a program is selected, the time reading on the display will stop blinking. Touch this button lightly, the washing machine will start operation automatically; touch it again during operation, operation will pause and the time reading on the display will blink. Press it again to resume operation.



H Anti-crease soaking button

Press this button, the washing machine will start a soaking cycle when the preset softening program is due during any of the synthetic, wool, cashmere and silk wash cycles. Now the washing machine will not drain but start a soaking cycle. And the soaking indicator will blink. If you want to spin the laundry, press this button again, operation will resume.

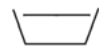

I Delay wash button

Press this button, the washing machine will start to adjust delay time. Each press of the button, the delay will increase 30 minutes. Keep pressing the button and the delay time will keep increasing. The range is 0-24 hours. For example, adjust it to 10 hours, press the "start" button and the washing machine will end 10 hours later. The delay time should be longer than the washing time. Don't press this button, if the delay time isn't needed.



Program description table

HG1200TXVE/HG1200TXVEME HG1000TXVE/HG1000TXVEME HG800TXVE/HG800TXVEME								
Mode Selection (Program Knob Position)	Recommended Laundry	Max Temperature	Program Time (when max temp is selected)	Detergent			Remarks	
				1	2	3		
Cottons	Pre-wash	Heavy-soil laundry	90°C	2:32	★	★	○	
	Intensive	Medium-soil laundry	90°C	2:22	×	★	○	
	Normal	White cotton fabrics	75°C	1:53	×	★	○	
	Delicate	Fast colors and slight-soil cotton fabrics	60°C	1:35	×	★	○	
Synthetics	Intensive	Fast colors and heavy-soil laundry	60°C	1:31	×	★	○	
	Normal	Fast colors and medium-soil laundry	60°C	1:16	×	★	○	
Delicates	Wool	Wool fabrics	40°C	0:50	×	★	○	
	Cashmere	Cashmere fabrics	40°C	0:50	×	★	○	
	Silk	Silk fabrics	40°C	0:41	×	★	×	
	Quick	Slight-soil cotton, linen and synthetic fabrics	40°C	0:29	×	★	×	
PROGRAMME OPTIONS	Wash	Cotton, linen and synthetic fabrics	60°C	0:53	×	★	×	Wash only
	Rinse		/	0:31	×	×	○	Rinse & spin
	Spin		/	0:10	×	×	×	Spin only
	Drain		/	0:03	×	×	×	Drain only
	Soak		90°C/60°C	1:50/1:13	×	×	×	
Power off	Disconnect power / cancel program							

Note: ○ indicates that softener or bleach can be added if needed; ★ indicates that detergent must be added; × indicates that detergent must not be added.

The wash temperature indicates the maximum temperature. Different laundry requires different wash temperatures, functions and time. The above wash cycle times are intended as a guide only and will be subject to local conditions.

Soak wash program, suitable for needing disinfecting clean clothes, can't join detergent, if temperature is 60-90 degrees Centigrade of ranges, The program heats to 90 degrees Centigrade, the temperature is suitable for sterilization of fabric of flax wash; if temperature is 0-60 degrees Centigrade of ranges, it will heat to 60 degrees Centigrade, this temperature is suitable for the sterilization of the chemical fibre manufactured goods

Preparation

1. Power supply

Plug in the power supply 220-230V~/50Hz.



2. Water supply

Turn on the tap ensure that the water is clear.

Caution: Before starting the washing machine turn on the water faucet to ensure that the water faucet and the water inlet hose are connected correctly and do not leak.



3. Detergent selection

Only special low foam detergent should be used in automatic drum washing machine, form blended or wool fabrics special detergent should be used. dry cleaning solvent should not be used such as trichloroethylene or alike (caution :load the required amount of detergent only).

4. Laundry treatment

- sort out clothes according to type and extent of dirt. There are three types of clothes: cotton, synthetical and woolen (silk) fabrics.
- separate white clothes from colored. If whites and coloreds are combined for one load, make sure the coloreds are colorfast.
- Remove all objects from pockets that may cause damage to the machine, such as keys and coins.

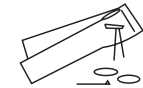

- Clothing with frayed edges or yarns should be put in a wash bag or special bag before washing.
- Repair damaged clothing, lose buttons or damaged zips and hooks before washing.
- Bed sheets and table ware should be loosely loaded and not folded.
- This washing machine is for household use and designed for mechanically washable clothes. When washing, separate unwashable clothes with reference to clothes labels.

5. Wash Load

Type	non-fade cottons	Delicat fabrics	Woolen fabrics	Blending fabrics
Max load	5 kg	2 kg	1 kg	2.5 kg

Free Manuals Download Website

<http://myh66.com>

<http://usermanuals.us>

<http://www.somanuals.com>

<http://www.4manuals.cc>

<http://www.manual-lib.com>

<http://www.404manual.com>

<http://www.luxmanual.com>

<http://aubethermostatmanual.com>

Golf course search by state

<http://golfingnear.com>

Email search by domain

<http://emailbydomain.com>

Auto manuals search

<http://auto.somanuals.com>

TV manuals search

<http://tv.somanuals.com>