

# Haier

Automatic Drum Washing Machine

HVS1200  
HVS1000

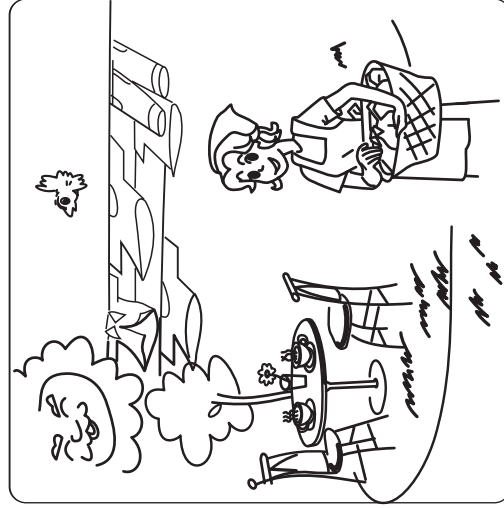

## Table of Contents

### Before using the appliance

Name of parts...inside front cover	
Matters needing attention.....	1-3
Installation.....	4-5
Function .....	6-8

### How to operate the washing machine

Program description table.....	9
Preparation .....	10
Washing Procedure .....	11-12

### Maintenance

Maintenance .....	13
Troubleshooting Guide .....	14
Technical Specifications .....	15
Wiring Circuit .....	16

# Name of Parts

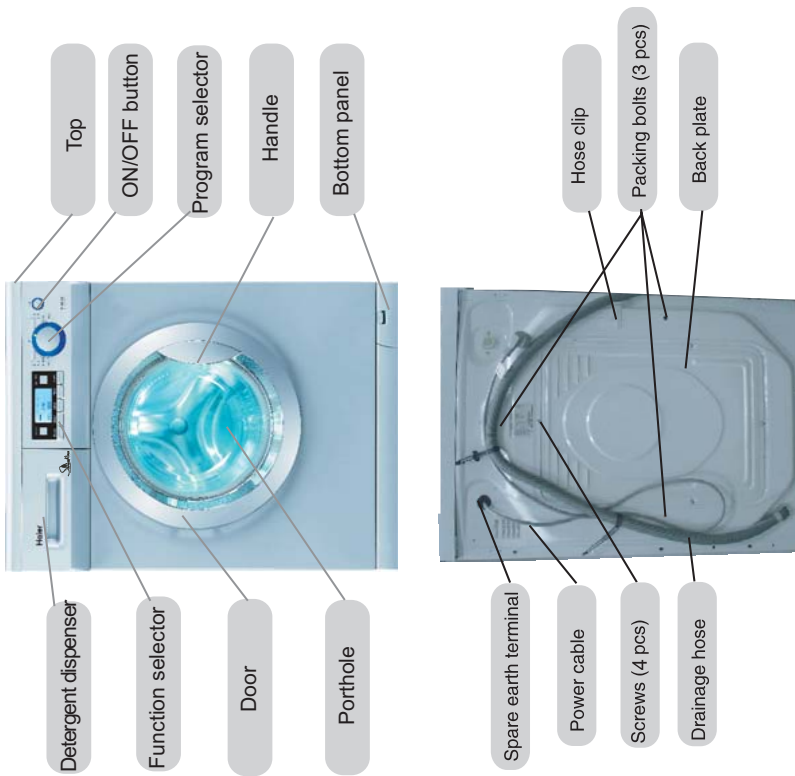

Caution and Warning symbols	
	For you safety, any instructions in this manual with this "Warning" sign must be followed strictly.
	For your safety and to prevent damage to the washing machine, any instructions in this manual with this "Stop" sign must be followed strictly.

This diagram may be slightly different from the layout of the washing machine you have just purchased due to technical improvements

# Wiring Circuit



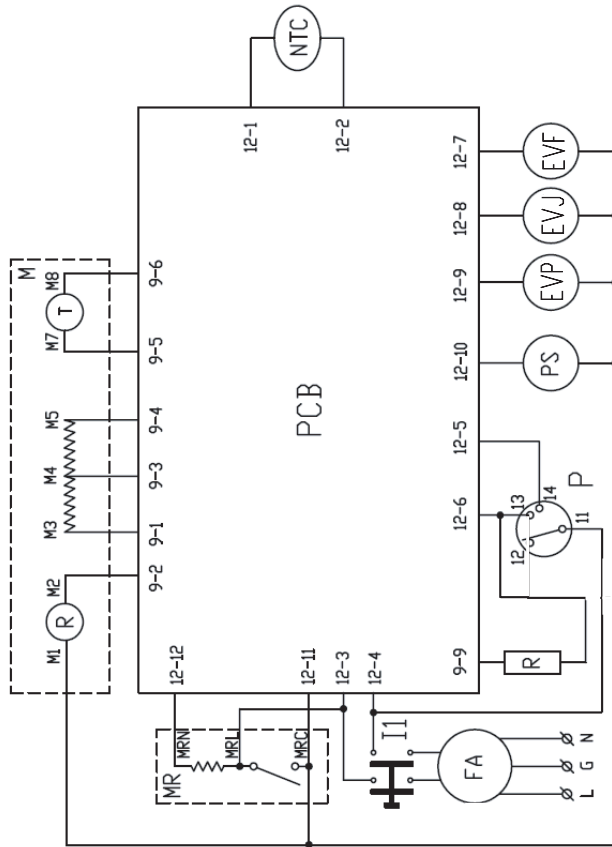



HVS1200  
HVS1000

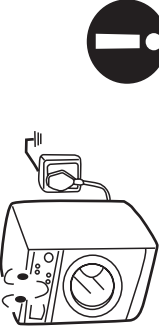

- 11-Switch
- M - Motor
- PCB - Printed Circuit Board
- MR - Door Lock
- R - Heating Element
- PS - Drainage Pump
- EVF, EVJ, EVP - Water Inlet Magnetic Valve
- P - Pressure Switch
- FA - Interference Suppressor
- NTC - Temperature Sensor

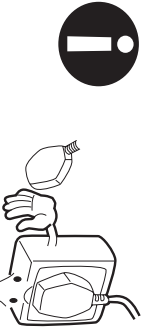
# Matters Needing Attention

## ● Safety

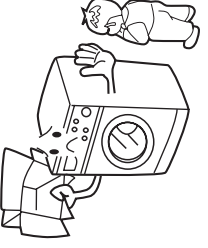
<p>1. A separate earthed socket is required for the power supply. The washing machine must be positioned so that the plug is accessible.</p> 	<p>2. Hold the plug and not the electric cable when unplugging the washing machine.</p> 
<p>3. Fuses in the power circuit should be rated for 15A. If the supply cord is damaged, it must be replaced by the manufacturer, its service agent or similarly qualified persons in order to avoid a hazard.</p> 	<p>4. Do not touch or use the washing machine barefooted or when the hands or feet are wet.</p> 
<p>5. Do not use flammable detergent or dry cleaning agent; do not use flammable spray in close vicinity to the washing machine; do not remove or insert the plug in the presence of flammable gas.</p> 	<p>6. The door of the washing machine will become hot during the heating process. Avoid contact with the door during the heating process. For safety, keep children away from the washing machine.</p> 
<p>7. Keep children away from the packing materials after unpacked.</p> 	



## Technical Specifications

Model	HVS1000	HVS1200
Power supply	(220-240)V~/(50Hz)	(220-240)V~/(50Hz)
Power(Max)	2000	2000
Water pressure (MPa)	$0.03 \leq p < 1$	$0.03 \leq p < 1$
Max. wash load (kg)	5	5
Spinning speed (MAX) (r/min)	1000	1200
Wash program	11	11
Heating power (W)	1800	1800
Net weight (kg)	82	82
Anti-Electric shock	I	I
Anti-Water class	IPX4	IPX4

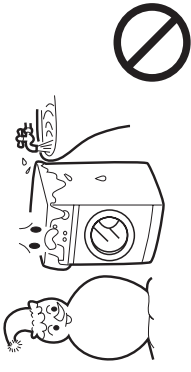
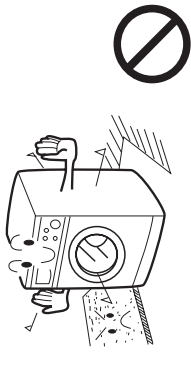
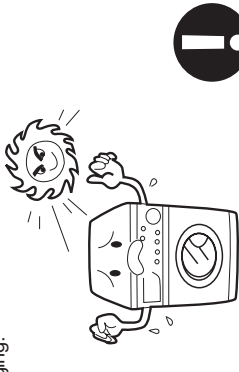
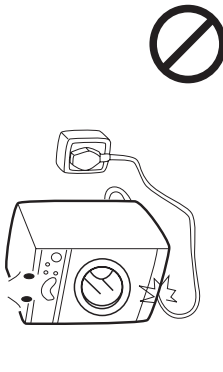



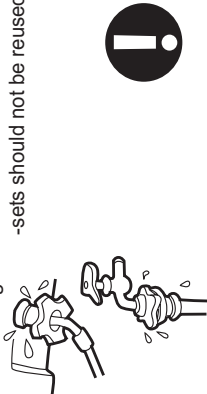





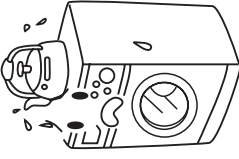

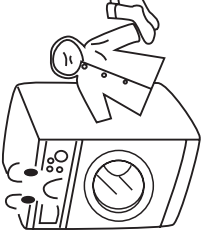

## Matters Needing Attention

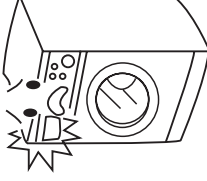
<p>8. The washing machine should not be installed outdoors or in a damp place. In the event of water leakage or splashes allow the machine to dry naturally.</p> 	<p>9. The carpet must not obstruct the ventilation openings in the base of the washing machine.</p> 
<p>10. Keep away from heat sources and direct sunlight to prevent plastic and rubber components from aging.</p> 	<p>11. During installation, ensure that the electric cable is not trapped by the washing machine and avoid damage to the electric cable.</p> 

## During Use

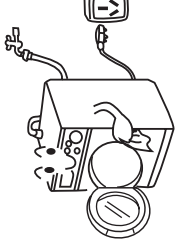
<p>1. Before use, check the joints of the filling hose, the tap and the drainage hose for possible problems from water pressure fluctuations. If joints are loose or there is leakage, turn off the tap and repair. Do not use the washing machine until the hoses are properly fixed. The appliance is to be connected to the water mains using new hose-sets and that old hose-sets should not be reused</p> 	<p>2. Keep the door slightly open when the washing machine is not in use to prevent formation of odors; do not cover the washing machine with plastic cover so that inside dampness cannot be kept in.</p> 
---	--

## Matters Needing Attention

<p>3. Do not place heavy, heating source or wet articles on the top of the washing machine.</p>  	<p>4. Do not hot wash foam rubber or sponge-like materials.</p>  
<p>5. Before washing, do up zippers, buttons and clothes straps and put small articles, such as socks, laces or bras, into a washing bag or a pillow.</p> <p>Steel wires in bras will pop out during washing; never wash bras containing steel wires.</p>  	<p>6. Do not open the detergent distribution drawer during the wash cycle.</p>  
<p>7. The door is fitted with a self-lock device and will not open until 2~3 minutes after the washing machine stops. Do not force the door open. Do not open the door if water level can reach the porthole.</p>  	<p>8. After each wash program, turn off the tap to prevent leakage; and unplug the washing machine and wipe clean the lower part of the porthole.</p>  
<p>9. Keep the door slightly open when the washing machine is not in use to prevent formation of doors; do not cover the washing machine with plastic cover so that inside dampness cannot be kept in.</p>  	

## Troubleshooting

The following circumstances do not constitute problems. Do not contact the maintenance service until the problem has been confirmed.

Problem	Possible cause
The washing machine fails to operate	<ul style="list-style-type: none"> <li>● Poor connection to power supply</li> <li>● Power failure</li> <li>● Door is not properly closed (It will show E1)</li> <li>● Machine has not been switched on</li> </ul>
Washing machine cannot be filled with water	<ul style="list-style-type: none"> <li>● Water tap is not turned on (It will show E4)</li> <li>● Water pressure is less than 0.03Mpa</li> <li>● The inlet hose is kinked</li> <li>● Water supply failure</li> <li>● The program dial is not properly set</li> <li>● The door is not properly closed</li> <li>● The inlet hose filter is blocked</li> </ul>
The machine is draining while is being filled	<ul style="list-style-type: none"> <li>● The height of the drainage hose is below 80cm (it should be within 80-100cm)</li> <li>● The drainage hose end is in water</li> </ul>
Drainage failure	<ul style="list-style-type: none"> <li>● Drainage hose is blocked (It will show E2)</li> <li>● Drainage hose end is exceed 100cm above the floor level</li> <li>● The filter is blocked</li> </ul>
Strong vibration during spin drying	<ul style="list-style-type: none"> <li>● Not all packing bolts have been removed</li> <li>● Washing machine is located on an uneven surface</li> <li>● Machine load is over 5kg.</li> </ul>
Operation stops before completion of a wash cycle	<ul style="list-style-type: none"> <li>● Water or electricity failure</li> <li>● Washing machine is in soak cycle</li> </ul>
Operation stops for a period of time	<ul style="list-style-type: none"> <li>● Washing machine is in soak cycle</li> <li>● Washing machine gives an error message.</li> </ul>
Excessive foam in the drum, which is spilled to the distribution drawer	<ul style="list-style-type: none"> <li>● The detergent is not a low-foaming type or for manual wash</li> <li>● Excessive use of detergent</li> </ul>

# Installation

- Remove all the packing materials (including the EPE base) to prevent vibration during use, as shown in the right picture. Upon opening of the package, water drops may be seen on the plastic bag and the porthole. This is normal phenomenon resulting from water test in the factory.

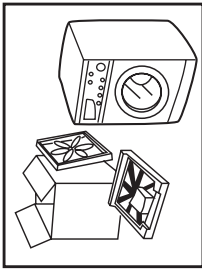

- Check attachments and materials with reference to the following

Qty	Name	Operation manual	Quality certificate	Water hose	Drainage holder	Warranty card	Plastic plugs
1	HVS1200 HVS1000	1	1	1	1	1	3

- Dismantle the packing bolts as shown in Fig. 2.

The packing bolts are designed for clamping anti-vibration components inside of the washing machine during the transportation process.

Before use:

1. Remove the back plate;
2. Remove the three packing bolts on the back plate and take out the rubber hose;
3. Replace the back plate;
4. Fill the holes left by the packing bolts with plastic plugs.  
(Attention: The packing bolts and rubber hose should be kept in a safe place for later use)

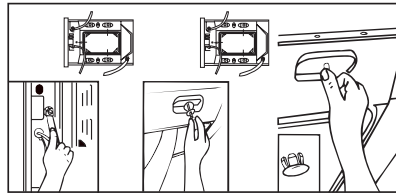

Fig.2

- Adjusting the washing machine

There are adjustable feet under the bottom of the washing machine. Before use, the washing machine should be adjusted, as shown in Fig. 3, so that it is level.

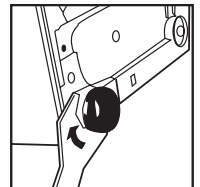

Fig.3

# Maintenance

1. Turn of the water and electricity supply after every wash. Open the door to prevent the formation of moisture and odors. If the washing machine is left idle for a long period, drain any remaining water in the machine and replace the drainage hose.

3. Clean the detergent compartment regularly. For the detergent compartment similar to figure (a), raise the compartment slightly to remove and replace after cleaning.



Fig.(a)

4. Clean the filter cleaning methods (once a month)
  - 1) Pick up the bottom cover lightly (Fig. 1);
  - 2) Screw out filter by turning counterclockwise (Fig. 2);
  - 3) Flash clean with running water;
  - 4) Replace the filter by turning clockwise and remount the cover.

Caution: The filter must be in place, or it may lead to leakage. (Fig3)

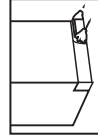

Fig1

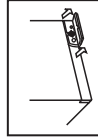
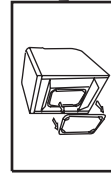

Fig2



Fig3

6. If the machine is to be moved a distance location, replace the vibration mounting locks which were removed during installation as shown below.



Remove the back cover.



Remove the rubber plugs.

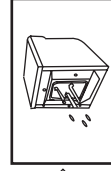

Insert the bolts.



Tighten the bolts with the spanner.

Replace the rear panel.

5. To prevent blockages to the water supply or the ingress of contaminants, clean the water inlet and inlet water filter regularly.

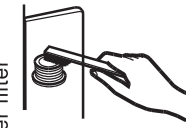

7. If the washing machine is left idle for a long period turn off the water and electricity supply and open the door slightly to prevent the formation of moisture and odors.

## Hints for Saving Energy

### 4. Setting washing temperature

Press the temperature button until "--" is displayed if heating is not needed; otherwise, select an appropriate temperature as required (refer to the "Guide to Operational Program Selection").

### 5. Function selecting button

Select functions as required (refer to the "Operational Functions" section).

### 6. Washing

Press Start/Pause key and the LCD will display "▶", which means the washer has started operation. The LCD will display program remaining time.

The following functions cannot be re-selected.

- 1). Temperature Selection Key
- 2). Reserve Time Key
- 3). Power Clean Key
- 4). All the functions already completed.

### 7. Finish

The washing machine will stop operation automatically when a wash cycle ends. The "End" sign will appear. Open the door and take out the laundry. Then turn off the tap and unplug the power cable.

### ● Hints for saving energy

During operation

1. Collect clothes for one full wash load.
2. Do not overload the washing machine.
3. Pre-wash heavily soiled clothes.
4. Reduce the amount of detergent or choose standard or delicate wash programs for slightly soiled clothes.
5. Choose a proper washing temperature. Only exceed 60°C for heavily soiled clothes.
6. Do not use more detergent than required.
7. Softening agent makes clothes feel softer and easier to iron.

## Installation

### Connection of water inlet hose and washing machine

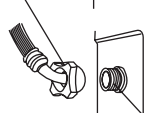
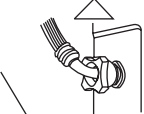
1. Place the water inlet hose nut on the connector of the water inlet valve.
2. Slightly shake the water inlet hose nut to see if it is tightly and properly fixed.

### Water drainage hose

● The height of the terminal of the water drainage hose should be placed between 80cm-100cm, the water drainage hose must be securely placed on the clip on the back of the washing machine.

● Use the water drainage support supplied as an accessory for proper installation of the water drainage hose. Fix the water drainage hose support with waterproof string. Do not use an excessively long water drainage hose and contract the authorized technician if the water drainage hose needs to be extended. The water drainage hose should not be extended more than 250cm. (longer extension will result in concurrent water inflow and outflow). The diameter of the extension hose should be the same as the original hose.

Caution: water drainage hose must not be immersed in water; the original and extension hoses should be tightly connected.

● The appliance is to be connected to the water mains using new hose-sets and that old hose-sets should not be reused.

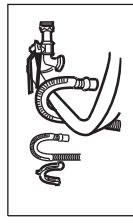
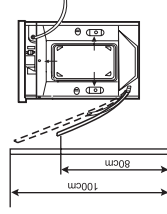

### Connection of power supply

Check the following items before connection to the power supply.

- The socket conforms to the maximum power load (The maximum current load of the socket and power supply cable should not be less than 15A).
  - power supply voltage conforms to the required value.
  - The power supply socket and the plug of the washing machine should be compatible, if they are not compatible, Refer to a washing machine technician or a Haier designated service point for power cable replacement. The washing machine should be connected to the earth before use.
  - Supplementary earth cable should not be necessary if the socket is connected to the earth.
  - Supplementary earth cable should be installed on the upper back of the washing machine and connected to an earth if the power supply socket has no earth connection.
- Caution: the supplementary earth cable should not be connected to water or heating pipes.

# Operational Functions

## Control Panel Function Description

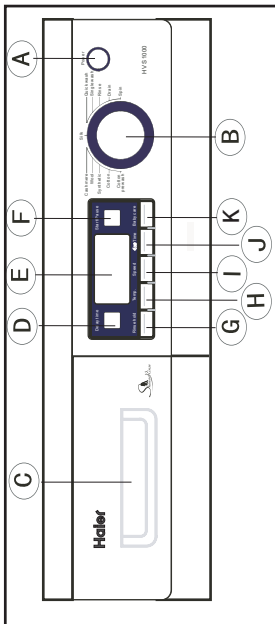

## Display Information Introduction

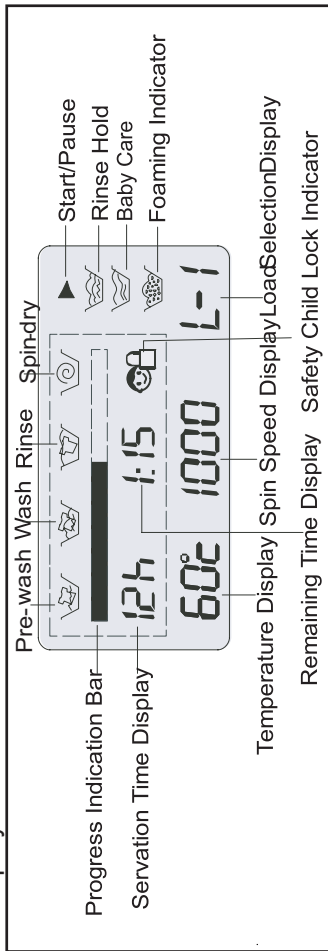

- A. Power On/Off Key**  
Press the key and the washer will be automatically energized, release the key and power is disconnected.
- B. Program Selection Knob**  
Turn the knob clockwise/counterclockwise to select the desired program. (please refer to Program Setting Guidance Table for details)
- C. Detergent Distribution Box- See Figure a for the drawer-type Detergent Dispenser**  
Open the dispenser box and you will see four detergent compartment of 1, 2, 3:  
 Compartment 1: Pre-wash Detergent  
 Compartment 2: Washing Detergent  
 Compartment 3: Softener, Conditioner and Perfume  
**Figure a**  

2	3	1
- D. Reservation Selection Key**  
Press the key to select the desired time when the washing progress completes. When setting this feature, the indicator lamp on the upper left corner of the key will illuminate. Time reservation range is from 1 to 24 hours. The reserved time will increase by one hour at each press of the key. When the feature is set, press Start/Pause key and the reserve time will be displayed and countdown will start. At the same time, reservation indicator lamp will start blinking and will go off after the washer enters into normal washing progress.

# Washing Procedure

## 1. Loading

Open the door, put in the laundry piece by piece. Close the door tightly.

Notes: 1) When first using the washing machine, let it run unloaded for one program to prevent the laundry from being tainted by oil or dirty water from the washing machine.  
 2) Do not overload the washing machine.

### Load Reference

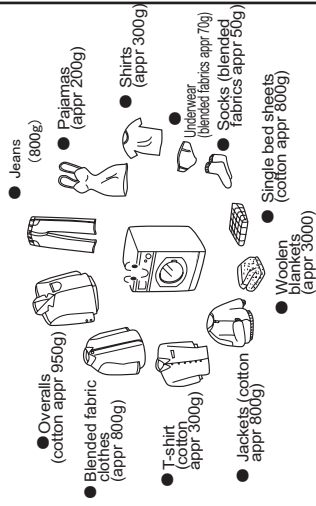

## 2. Adding detergent

Slide out the detergent drawer and put the required detergent and softening agent into the corresponding boxes. Push back the drawer gently.  
**Caution:**

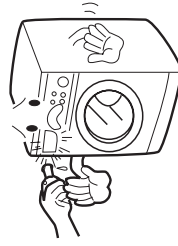

- 1) For pre-washing program, detergent should be added to both compartments 1 and 2. Compartment 2 allows only solid detergents. For other programs, do not add detergent to compartment 1.
- 2) Do not overuse softener; otherwise, it will damage the artificial fibers. Refer to the instructions during use.
- 3) The softener can not exceed the "MAX" on the siphon hat. And the softener should not be too ropy.
- 4) If select the delay-time function, make sure the compartment is dry, or the detergent will remain in the compartment.

## 3. Selecting washing program

To get the best washing effect, an appropriate washing program should be selected according to the laundry type.  
**Note:** The above operations refer to conditions without power-off memory. Or the washing machine will continue operation from where the program was broken. To clear memory, press the Start/Pause button. Turn off the power for a few seconds and turn on again, all the settings will be renewed.



# Preparation

**1. Power supply**  
Plug in the power supply ( 220 -240 ) V- /50HZ



**2. Water supply**

Turn on the tap ensure that the water in clear.

Caution: Before starting the washing machine turn on the water faucet to ensure the water faucet and the water inlet hose are connected correctly and do not leak



**3. Detergent selection**

Only special low foam detergent should be used in automatic drum washing machine, form blended or wool fabrics special detergent should ne used. dry cleaning solvent should not be used such as trichloroethy-lene or alike (caution :load the required amount of detergent only).

**4. Laundry treatment**

- Sort out clothes according to type and extent of dirt. There are three types of clothes: cotton, synthetic and woolen (silk) fabrics.
- Separate white clothes from colored. If whites and coloreds are combined for one load, make sure the coloreds are colorfast



- Clothing with frayed edges or yams should be put in a wash bag or special bag before washing
- repair damaged clothing, lose buttons or damaged zips and hooks before washing.
- Bed sheets and table ware should be loosely loaded and not folded.

- This washing machine is for household use and designed for mechanically washable clothes. When washing, separate unwashable clothes with reference to clothes labels.

**5. Wash load**

Type	Cotton fabrics	Synthetic fabrics	Wool/cashmere/silk fabrics
Max load	5kg	3kg	3kg

# Functions

**Note.**

If Program key is turned after reservation time is set and before program starts, the reservation will be automatically cancelled.

When reservation feature is activated, the washing start time is fixed. There will be some difference between the reserved time and the actual program completion time due to different water inlet time and load distribution condition during spin-dry process.

**E. LCD**

LCD is a window to display information including washing status, washing progress, reservation time, remaining time, heating temperature, spindry speed, load selection and error etc. as well as to display additional features such as power clean, super clean rinse and foaming auto-check etc.

**F. Start/Pause Key**

When the washer is energized, select the desired washing program and press the Start/Pause key. The indicator lamp on the upper left corner of the key will illuminate to indicate that the washer has started operation. If it needs to pause the washing process, simply press the Start/Pause key and the indicator lamp and remaining time display will blink and the washer enters into condition. Press the Start/Pause key again to resume washing process.

(Note: Press the Start/Pause key only after the desired program and feature are set.

**G. Rinse Hold Key**

Press the key lightly, the screen displays the symbol. The washing machine does not drain the water after the last rinse, but the laundry remains in a soak. To spin the laundry, press this key again. The symbol disappears from the screen and the program continues to the end. The function is used to prevent the laundry creasing when left in the drum for a long time.

**H. Temperature Selection Key**

Press the key and LCD will display the selected heating temperature, which is adjustable as needed. Note: 20°C means cold water washing and no heating is involved.

**I. Spin Speed Selection Key**

Press the key and LCD will display the selected spin-dry revolution speed, which is adjustable as needed. (When No Spindry feature is selected, the time will decrease correspondingly.)

**J. Load Selection key**

Turn the Program Knob to select the desired program (see Program Setting Guidance Table) Press the key and manually select different programs and power-saving and water-seaving feature based on the volume of load. LCD will display L-1(2,3,4,5), indicating the washing load is 1 (2,3,4,5) kg and program time will change accordingly. (The feature is not available in Wool, Cashmere, Silk, Speedy, Drainage Only and Spin Only Program. Only L- 1, 2, 3 are available for Chemical Fiber program.)

## Functions

### K. Super-clean Rinse Key

Press the key and super -clean icon in the LCD will illuminate. When the program comes to softening process, the washer will add an extra rinse process. ( This feature is not available in some programs. Please see Program Setting Guidance Table for details.)

### Introduction of Other Functions

- A. Power-off Memory Function:** The washer has power-off memory function. In case of abrupt power failure or the power must be cut off during a program cycle, the present settings will be saved and the preset operation will resume when the power is resumed. If it needs to cancel this feature, press Start/Pause key so that the washer will stop temporarily. Turn off the power key and restart the washer after a few seconds and the feature will be cancelled.
- B. Safety Child Lock Function:** During the operation of the program, press down Temperature key and Load Selection key concurrently and hold for 3 seconds. "🔒" will be displayed indicating that the program is locked. Repeat the above procedures to unlock.
- C. Foaming Auto-check Function:** The washer offers foaming auto-check function, which is a solution to incomplete rinse due to over-dispensing of detergent. The washer can sense the volume of foam formed automatically. When foaming is detected, the Foaming icon in the LCD will illuminate  and an extra rinse cycle will be added before the program completes. Program time duration will increase automatically.
- D. Auto-shower function:** With automatic shower rinse technology, it can efficiently reduce the residual detergent and make the rinse process more efficient and thorough. This function operates without any intervention from human.
- E. Display messages:**
- Err1: Door is not properly shut.  
Correction: Shut the door properly.
  - Err2: Drainage error, water not emptied within 4 min.  
Correction: Clean the filter and check the drain hose for blockage. If error still exists, please contact the maintenance personnel.
  - Err3: Temperature sensor short circuit or open circuit.  
Correction: Contact the maintenance personnel.
  - Err4: water heating element damage.  
Correction: Contact the maintenance personnel.
  - Err5: Water fails to meet the specified level within 8 minutes.  
Correction: Check the tap and the water pressure; if error still exists, please contact the maintenance personnel.
  - Err6: Motor do not work.  
Correction: Contact the maintenance personnel.
  - Err7: Motor overheat protection or damage.  
Correction: Restart the power key if still display Err7, contact the maintenance personnel.
  - Err8: Water exceeds protective level.  
Correction: Contact the maintenance personnel.
- End: End of a wash cycle.
- Unb: After the last rinsing cycle finishes, spinning fails completely due to an imbalance of the laundry.
- 1:25: Status information: Remaining program time.

## Program Setting Guidance Table

Program Setting Mode	Recommended Laundry	Default Program		Temperature Adjustment Range	Rinse Hold	Load Selection	Super Clean Rinse	Reserve	Detergent Usage Method		
		Capacity	Temperature						Total Time	Compartment 1	Compartment 2
Cotton Prewash	Heavily-soiled Cotton Fabrics	5	40	5:52 1000	YES	YES	YES	YES	★	★	○
Cotton	Cotton Fabrics	5	40	2:38 1000	YES	YES	YES	YES	★	★	○
Synthetic	Fsat-colour Fiber	3	60	1:42 800	YES	YES	YES	YES	★	★	○
Wool	Wool	/	40	1:10 600	YES	NO	YES	YES	★	★	○
Cashmere	Cashmere	/	40	1:10 400	YES	NO	YES	YES	★	★	○
Silk	Silk	/	40	1:05 400	YES	NO	YES	YES	★	★	○
Quick wash	Slightly-soiled Textiles	/	--	0:29 800	YES	NO	NO	YES	★	★	○
Single wash	Slightly-soiled Textiles	5	40	1:33 0	NO	YES	NO	YES	★	★	○
Rinse	Slightly-soiled Textiles	5	--	0:25 800	YES	YES	YES	YES	★	★	○
Drain	/	/	/	0:03	NO	NO	NO	YES	★	★	○
Spin	/	/	/	0:09 1000	NO	NO	NO	YES	★	★	○

**Note:** ○ means that it needs to add perfume such as softener ★ means that it needs to add detergent otherwise the desired washing result will not be achieved. x means it must not add detergent. The data in Speed column is default spin speed of corresponding model (when speed is not selected.)

**Note: 1.** Washing temperature refers to the highest temperature allowable during the whole washing process. The washing time varies according to the type of clothes, selected temperature and feature. The total operation time provided in the above table is for reference only (There will be a slight difference due to different water temperature.)

**2.** For clothes made of special materials such as woolsens, cashmere and wool, please check if the clothes has a machine-washing tag and the requests to the temperature.

## Free Manuals Download Website

<http://myh66.com>

<http://usermanuals.us>

<http://www.somanuals.com>

<http://www.4manuals.cc>

<http://www.manual-lib.com>

<http://www.404manual.com>

<http://www.luxmanual.com>

<http://aubethermostatmanual.com>

Golf course search by state

<http://golfingnear.com>

Email search by domain

<http://emailbydomain.com>

Auto manuals search

<http://auto.somanuals.com>

TV manuals search

<http://tv.somanuals.com>