

**Water Dispenser**  
**Fontaine d'eau Réfrigérée**  
**Dispenser de Agua**



WDNS045

**User Manual**

---

**Manual d' Utilisateur**

---

**Manual de Usuario**



**WDNS045**  
**WDNS055**  
**WDNSC145**  
**WDNS201SS**

**Haier**

**Quality <sub>n</sub> Innovation <sub>n</sub> Style**

Download from [www.Somanuals.com](http://www.Somanuals.com). All Manuals Search And Download.

## SAFETY PRECAUTIONS

**Read all of the instructions before using this appliance. When using this appliance, always exercise basic safety precautions, including the following:**

1. Use this appliance only for its intended purpose as described in this use and care guide.
2. This water dispenser must be properly installed in accordance with the installation instructions before it is used. See the grounding instructions in the installation section.
3. Never unplug your water dispenser by pulling on the power cord. Always grasp the plug firmly and pull straight out from the outlet.
4. Repair or replace immediately, all electric service cords that have become frayed or otherwise damaged. Do not use a cord that shows cracks or abrasion damage along its length, on the plug or at the connector end.
5. Unplug your water dispenser before cleaning and making any repairs.  
Note: If for any reason this product requires service, we strongly recommend that a certified technician perform the service.
6. This water dispenser should not be recessed or built into an enclosed cabinet. It is designed for freestanding installation only.
7. This appliance is designed for INDOOR USE ONLY and should not be used outdoors.
8. Do not operate your water dispenser in the presence of explosive fumes.
9. Close supervision is necessary when any appliance is used by or near children.
10. To protect against electric shock, do not immerse the cord, plug, or any other part of the water dispenser in water or other liquids.

### SAVE THESE INSTRUCTIONS

#### For Future Use

Thank you for purchasing our Haier product. This easy-to-use manual will guide you in getting the best use of your water dispenser.

Remember to record the model and serial number. They are on a label in back of the unit.

---

Model number

---

Serial number

---

Date of purchase

**Staple your receipt to your manual. You will need it to obtain warranty service.**

# TABLE OF CONTENTS

	PAGE
<b>SAFETY PRECAUTIONS</b> .....	1
<b>PARTS AND FEATURES</b> .....	3-5
<b>UNPACKING</b> .....	6
Proper Location .....	6
<b>ASSEMBLY INSTRUCTIONS</b> .....	6-8
Installing Your Water Dispenser .....	6
Assembly of Storage Compartment (WDNSC145 only).....	7-8
<b>ELECTRICAL CONNECTIONS</b> .....	8
Grounding Instructions.....	8
Wiring Requirements .....	8
Extension Cords.....	8
Power Interruptions .....	8
<b>OPERATING YOUR WATER DISPENSER</b> .....	9
Cold/Hot Water Release.....	9
Cold/Hot Water Indicator Lights .....	9
Using the Refrigerator Compartment.....	9
Using the Storage Compartment .....	9
Removable Drip Tray .....	9
<b>PROPER CARE AND CLEANING</b> .....	10-11
General .....	10
Cleaning the Condenser Coils .....	11
For Long Vacations or Absences / Moving .....	11
<b>TROUBLESHOOTING GUIDE</b> .....	12-13
<b>LIMITED WARRANTY</b> .....	14

## PART AND FEATURES

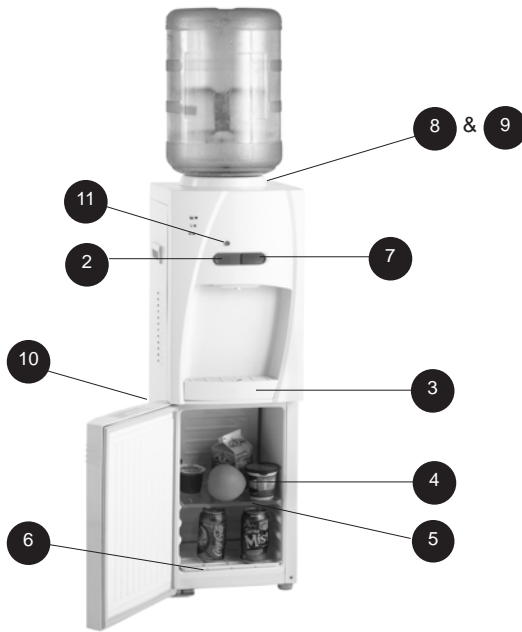

	WDNS045	WDNS055
1. Dust Cover (save for cleaning purposes) - not shown	yes	yes
2. Hot Water Release Button (red)	yes	yes
3. Removable Drip Tray	yes	yes
4. Storage Compartment	non-refrigerated	refrigerated
5. Removable Adjustable Shelf	yes	yes
6. Defrost Water-Collecting Tray	no	yes
7. Cold Water Release Button (blue)	yes	yes
8. Cold Water Switch (blue) - not shown	yes	yes
9. Hot Water Switch (red) - not shown	yes	yes
10. Drain - not shown	yes	yes
11. Child Safety Lock	yes	yes

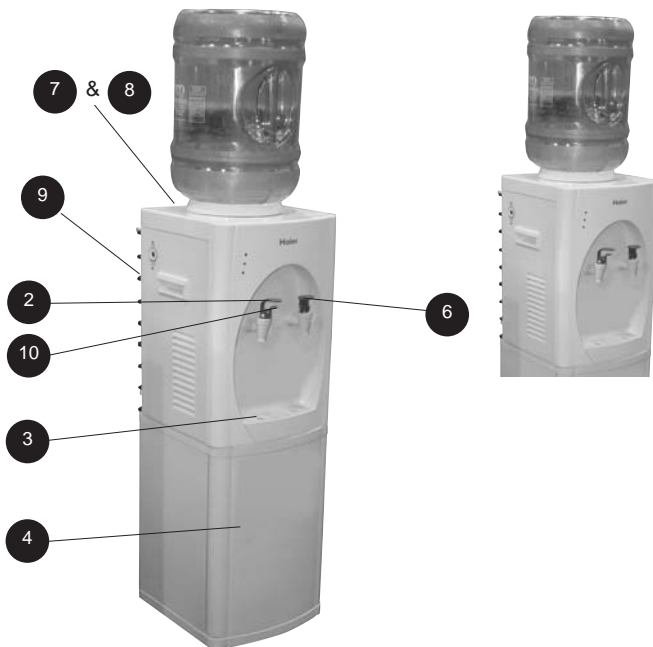

Convertible Table Top or Free Standing	WDNSC145
1. Dust Cover (save for cleaning purposes) - not shown	yes
2. Hot Water Release Button (red)	yes
3. Removable Drip Tray	yes
4. Storage Compartment	non-refrigerated
5. Removable Adjustable Shelf (not shown)	yes
6. Cold Water Release Button (blue)	yes
7. Cold Water Switch (blue) - not shown	yes
8. Hot Water Switch (red) - not shown	yes
9. Drain - not shown	yes
10. Child Safety Lock	yes

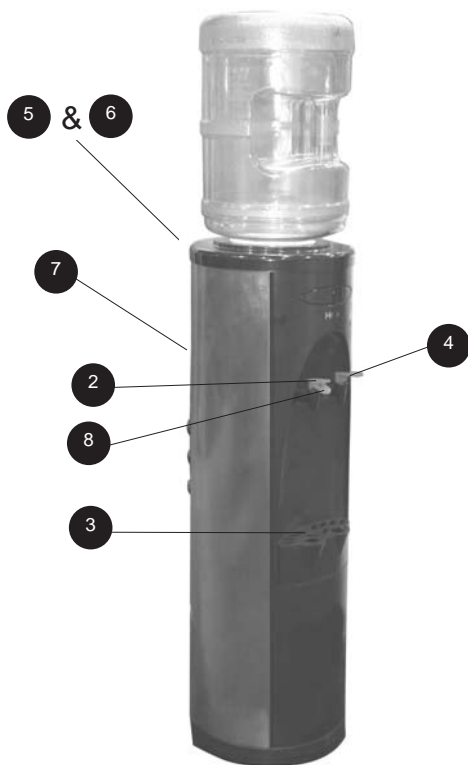

	WDNS201SS
1. Dust Cover (save for cleaning purposes) - not shown	yes
2. Hot Water Release Faucet (red)	yes
3. Removable Drip Tray	yes
4. Cold Water Release Faucet (blue)	yes
5. Cold Water Switch (blue) - not shown	yes
6. Hot Water Switch (red) - not shown	yes
7. Drain - not shown	yes
8. Child Safety Lock	yes

## UNPACKING

1. Remove all packing materials. This includes the foam base and all adhesive tape holding the accessories inside and outside.
2. Inspect and remove any remaining packaging, tape and printed material before turning on the water dispenser.

Note: Allow the water dispenser to stand in an upright position for at least 10 hours before turning on the power.

### Proper Location

- To ensure that your water dispenser works at the maximum efficiency it was designed for, you should install it in a location where there is proper air circulation and electrical connections.

- The following are the recommended clearances around the water dispenser.

Sides 2" (50mm)

Back 4" (100mm)

- Do not install your water dispenser in any location that is not properly insulated or heated because the unit is not designed to operate in room temperature below 55°F / 13°C. The water dispenser is for indoor use only. Room temperature should not exceed 97° F / 36° C.

Note: The built-in thermostat maintains the hot and cold temperatures automatically. On the compressor cooled water coolers the hot water temperature will be between 185°- 201.2° F / 85°- 94° C and the cold water temperature will be between 39.2°- 50° F / 4°-10° C.

- Select a suitable location for the unit on a hard even surface away from direct sunlight and heat sources (e.g., radiators, baseboard heaters, cooking appliances, etc.)

Note: Hot and cold water will not be instantly available as the unit will need time to heat up and cool down the water.



**CAUTION: DO NOT plug in the water dispenser until water flows through both Hot and Cold water faucets.**

## ASSEMBLY INSTRUCTIONS

Read carefully and understand all installation instructions before installing the water dispenser.

### Installing Your Water Dispenser

Follow the steps below to install the water dispenser.

1. Remove the cap from the water bottle first. Lift up the water bottle and quickly place it into the water guard. (The water bottle is not included.)
2. DO NOT plug in the water dispenser until you have checked that water flows out of both the red and blue faucets when pressed. Never turn on the water dispenser without water in it. Doing so may cause the unit to catch fire or malfunction.
3. Check that water flows out by pressing both the red and blue water release buttons one at a time.
4. Plug the power cord into an 115volt / 60 Hz outlet.
5. To activate the water heater and cooler, turn ON the red and blue switches on the back of the unit. The hot & cold indicators in the front will be lit.

## ASSEMBLY OF STORAGE COMPARTMENT

(WDNSC145 Only)

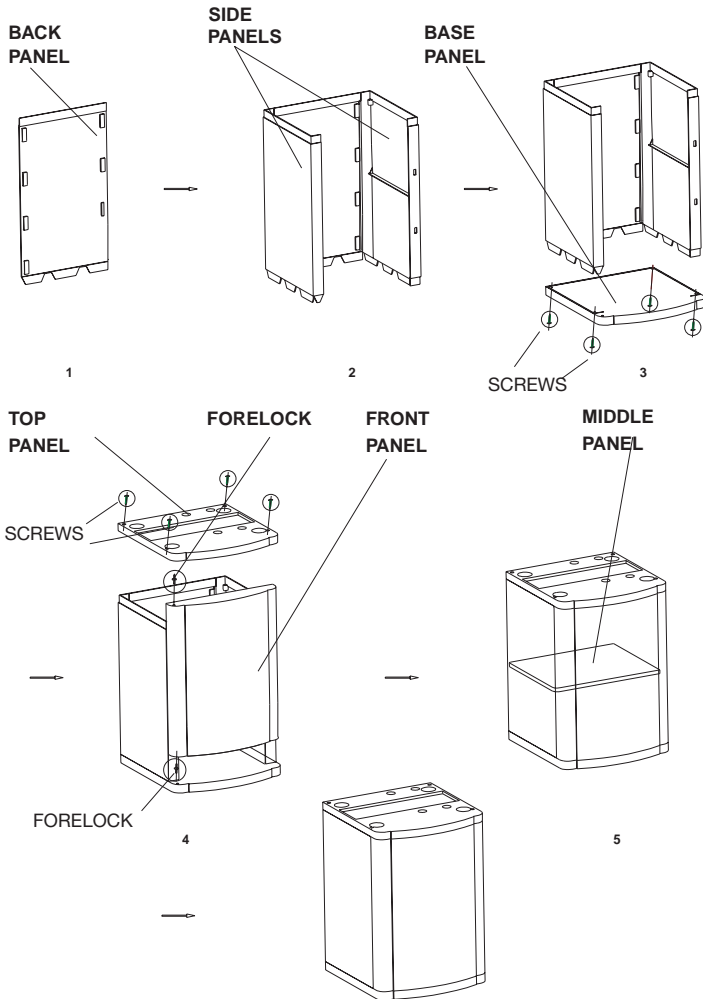

1. As shown in fig. 1 and fig. 2, attach the side panels to the back panel.
2. Secure the base to the upper section with the provided screws.
3. Place the front panel on the base panel. Make sure that the hole on bottom left of the door is aligned with the forelock.
4. Attach the top panel with the provided screws as shown, making sure that the forelock is properly in place on the upper left side of the door and the top panel is aligned with the forelock.
5. Place the middle panel inside the storage compartment as shown. The water dispenser can now be set on the unit.



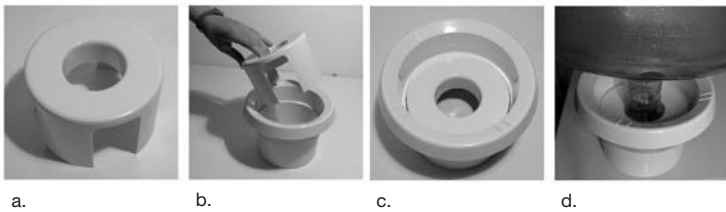

Note: Your units come with a bottle secure bracket as seen in figure A. Use the bracket shown above to keep the water bottle stable and tightly secured. This will help when the water level is low in the bottle and avoid bottle wobbling. To use simply place the bracket inside the water bottle holding receptacle as shown in figure B. Now place the water bottle on the cooler as shown in figure D.

## ELECTRICAL CONNECTIONS

### Grounding Instructions

This appliance must be grounded. In the event of an electrical short circuit, grounding reduces the risk of electric shock by providing an escape wire for the electric current. This appliance is equipped with a cord containing a grounding wire and a grounded plug. The plug must be inserted into an outlet that is properly installed and grounded.



- Improper use of the plug may result in the risk of electric shock.
- Consult a qualified electrician or service technician if the grounding instructions are not completely understood or if in doubt as to whether the appliance has been properly grounded.

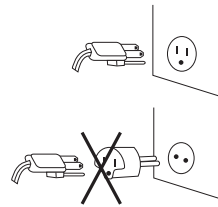

### Wiring Requirements

This appliance must be plugged into a 15Amp, 115 Volt, 60Hz GROUNDED OUTLET.

**Note:** Where a standard two-prong outlet is encountered, it is the personal responsibility and obligation of the consumer to have it replaced with a properly grounded three-prong outlet.



### Extension Cords

We do not recommend the use of an extension cord with this unit.

### Power Interruptions

Occasionally, there may be power interruptions due to thunderstorms or other causes. Remove the power cord from wall outlet when a power outage occurs. When power has been restored, re-plug the power cord into wall outlet.

## OPERATING YOUR WATER DISPENSER

This water dispenser maintains instant hot and cold water for your cooking and drinking needs. It accepts 2, 3 or 5-gallon water bottles.

(For WDNS045, WDNS055)

### Cold (blue) / Hot (red) Water Release Buttons

- Press the button in to release the water flow.

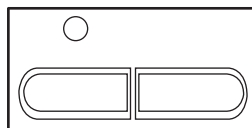

**Note:** The hot (red) water button is equipped with a child safety lock to prevent accidental spilling of hot water. To release the hot water flow, the button must be pushed along with the child safety button, which is located right over the water release button.

**Caution! Be careful when carrying hot water in your cup or container to avoid any injury or harm from spills.**

### Cold (blue) / Hot (red) Water Indicator Lights

When the blue and red lights are illuminated on the front of the unit, the heating and cooling process is in progress. When the cold and hot water has reached their proper temperatures, both lights will turn off automatically. Normally, hot water reaches proper temperature first.

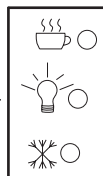

For WDNS201SS and WDNSC145

- Press the red child safety lever along with the tap and push down to get Hot water. For Cold water, push down the Blue tap.

### Using The Refrigerator Compartment (only in WDNS055)

The convenient refrigerator compartment can be very useful in storing beverages and other perishable food items.

- When the dispenser is turned on for the first time, avoid food spoilage by waiting at least few hours before putting any food or beverages into the compartment, as the compartment may not be cool enough to store foods.



### Using the Storage Compartment (not in all unit)

The convenient storage compartment can be very useful in storing instant drink mixes such as coffee, tea, hot chocolate powder and other snacks.

You may store items in both the upper and lower levels of the compartment. Remove the plastic shelf to store taller items.



### Removable Drip Tray

The spilled water in the drip tray must be removed regularly and cleaned properly to avoid any bacteria and residue build-up. To remove it gently, lift the tray up.

## PROPER CARE AND CLEANING

**Caution!** Before using any cleaning product, always read and follow the manufacturer's instructions and warnings to avoid personal injury and/or product damage.

**Note:** It is best to clean the dispenser and its surrounding area in between replacing the empty bottle with a new one. This way you can move the unit easily without the weight of the bottle.

### General

- Before cleaning, place the dust cover on top of the water guard to prevent dust and debris from going into the dispenser while cleaning.

### **WARNING!**

**Always unplug the unit before cleaning to avoid electric shock.  
Failure to do so may result in death or injury.**

- Prepare a cleaning solution of 3-4 tablespoons of baking soda mixed with warm water. Use a sponge or a soft cloth dampened with the cleaning solution to wipe down the unit.
- Wipe with clean warm water and dry with a soft cloth.
- Do not use harsh chemicals, abrasives, ammonia, chlorine bleach, concentrated detergents, solvents or metal scouring pads. Some of these chemicals may dissolve, damage and/or discolor the unit.
- The spilled water in the drip tray must be removed regularly and cleaned properly to avoid any bacteria and residue build-up.
- We recommend that you clean the water dispenser at least twice a year. When cleaning, you do not need to take anything apart. Simply pour the baking soda/water solution through the water guard. Then rinse with plenty of water and allow the water to drain.
- On the WDNS055, to clean the refrigerated compartment, let the built up ice melt. Do not use sharp objects or a knife to remove the ice built up. Do not use boiling water to remove the ice.
- Remove the accumulated water from the drip tray, and wipe the compartment clean.

### Cleaning the Condenser Coils

- We recommend that you move the dispenser away from the wall and vacuum or brush the coils on the rear of the unit at least 4 times a year. Some operating environments may require more frequent cleaning.

### For Long Vacations or Absences / Moving

- Turn OFF the cold and hot water switches.
- Unplug the unit.
- Put a container or bucket on the floor under the drain on the back of the unit to catch the water released from the drain tube.
- Remove the drain plug located on the side of the unit to release the water and empty both the tanks.

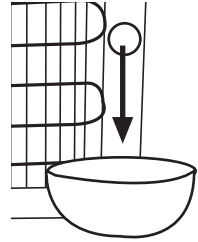

**Note: Remove drain plug by turning it in a “clockwise direction”. Please note not to use any tools to remove or install the drain plug. Use hands only.**

- After completing the drain process, replace the drain plug to its original position.
- You must store the unit at room temperature.
- Avoid storing the unit where the temperature is at or below freezing.
- When moving, the unit must be moved vertically. DO NOT move the unit in horizontal position as this may cause possible damage to internal parts.
- You must cover the unit to avoid dust and debris from entering the water guard.

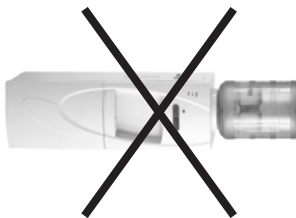

## TROUBLESHOOTING GUIDE

### **If the power is switched on and the compressor will not start up:**

- Make sure the power cord is plugged in properly
- If the water dispenser is brought indoors in the winter, give it a few hours to warm up to room temperature before plugging it in. Cold bottled water or the temperature of the water dispenser itself may affect the thermostat setting. If the room temperature is lower than the thermostat setting or the water dispenser itself is cold the compressor will not start up. We do not advise that you make any adjustments to the thermostat setting.

### **If water dispenser operation is noisy:**

- Make sure the water dispenser sits on a level surface. If the dispenser is noisy after its first use, unplug it for half an hour and try again.

### **If the condenser becomes too hot:**

- When the compressor is working, it is normal for the condenser to be hot. If you are concerned that the temperature is too high, check to see that there is enough room around the water dispenser to allow proper ventilation.

### **If the contents of the cooling compartment are not cold enough:**

- Make sure the cooling compartment door is closed tightly.

### **If the compressor is running non-stop:**

- Make sure the cooling compartment door is closed tightly.

### **If the cold water tap doesn't work and the cold water tank freezes:**

- The cold water tap may freeze under extreme conditions. If the water is not being used, the cooling compartment is loaded and the compressor is running continuously, the cold water tank can freeze.
- The cooling load may be too warm. We do not advise that you place items that exceed 40°C in the refrigerator.
- The door of the cooling compartment may not be closed.
- To thaw the cold water tank, turn off and unplug the unit and remove the water bottle. Keep draining hot water and pouring it back into the water receptacle. Once the tank has thawed, place the bottle on the unit, plug the unit back in and turn it on.
- If you want to continue using the cooling compartment, keep the door closed and reduce the cooling load inside the cooling compartment. You may turn the cold water and cooling compartment switch on once the cold water tank is thawed.

### **If the cold water is warm:**

- This is due to either a compressor malfunction (for units with compressor) or the cold water switch may be in the OFF position.
- Check if the cold water button is in the On position.
- Cold water is used very frequently.

**If water leaks from the tap:**

- A calcium deposit may have formed in the tap. Wash the inside of the water dispenser.

**If water is dripping from the dispenser onto the floor:**

- The water bottle may have small pinholes.
- The drain plug in the rear may be improperly fastened. Check that the soft rubber seal is not torn or damaged.
- The drip tray at the bottom of the cooling compartment may be full of water. Take out the drip tray and empty it before replacing it.

## LIMITED WARRANTY

### What is covered and for how long?

This warranty covers all defects in workmanship or materials for a period of:

**12 months labor (carry-in only)**

**12 months parts**

The warranty commences on the date the item was purchased and the original purchase receipt must be presented to the authorized service center before warranty repairs are rendered.

### EXCEPTIONS: Commercial or Rental Use warranty

**90 days labor (carry-in only)**

**90 days parts**

**No other warranty applies**

### What is covered?

1. The mechanical and electrical parts, which serve as a functional purpose of this appliance, for a period of 12 months. This includes all parts except finish, and trim.

### What will be done?

1. We will repair or replace, at our discretion, any mechanical or electrical part which proves to be defective in normal usage during the warranty period so specified.
2. There will be no charge to the purchaser for parts and labor on any covered items during the initial 12 month period. Beyond this period, only parts are covered in the remaining warranty. Labor is not provided and must be paid by the customer.
3. Contact your nearest authorized service center. For the name of the nearest service center please visit our website at [www.HaierAmerica.com](http://www.HaierAmerica.com) or call 1-877-337-3639 for more information.

**THIS WARRANTY COVERS APPLIANCES WITHIN THE CONTINENTAL UNITED STATES, PUERTO RICO AND CANADA.**

**IT DOES NOT COVER THE FOLLOWING:**

Damages from improper installation.

Damages in shipping.

Defects other than manufacturing.

Damage from misuse, abuse, accident, alteration, lack of proper care and maintenance or incorrect current or voltage.

Damage from other than household use.

Damage from service by other than an authorized dealer or service center.

Decorative trims or replaceable light bulbs.

Transportation and shipping.

Labor (after the initial 12 months).

THIS LIMITED WARRANTY IS GIVEN IN LIEU OF ALL OTHER WARRANTIES, EXPRESSED OR, INCLUDING THE WARRANTIES OF MERCHANTABILITY AND FITNESS FOR A PARTICULAR PURPOSE.

The remedy provided in this warranty is exclusive and is granted in lieu of all other remedies.

This warranty does not cover incidental or consequential damages, so the above limitations may not apply to you. Some States do not allow limitations on how long an implied warranty lasts, so the above limitations may not apply to you.

This warranty gives you specific legal rights, and you may have other rights, which vary, from state to state.

Haier America  
New York, NY 10018

# **IMPORTANT**

## **Do Not Return This Product To The Store**

If you have a problem with this product, please contact the  
"Haier Customer Satisfaction Center" at 1-877-337-3639.

**DATED PROOF OF PURCHASE REQUIRED FOR WARRANTY SERVICE**

# **IMPORTANT**

## **Ne pas Réexpédier ce Produit au Magasin**

Pour tout problème concernant ce produit, veuillez contacter le service des  
consommateurs 'Haier Customer Satisfaction Center' au 1-877-337-3639.

**UNE PREUVE D'ACHAT DATEE EST REQUISE POUR BENEFICIER DE LA GARANTIE.**

# **IMPORTANTE**

## **No regrese este producto a la tienda**

Si tiene algún problema con este producto, por favor contacte el "Centro de Servicio al  
Consumidor de Haier" al 1-877-337-3639 (Válido solo en E.U.A).

**NECESITA UNA PRUEBA DE COMPRA FECHADA PARA EL SERVICIO DE LA GARANTIA**

**115V, 60Hz**

**Made in China**

**Fabriqué en Chine**

**Hecho en China**

# **Haier**

**Haier America**

**New York, NY 10018**

Issued: May - 05

Part # RF-9999-209



## Free Manuals Download Website

<http://myh66.com>

<http://usermanuals.us>

<http://www.somanuals.com>

<http://www.4manuals.cc>

<http://www.manual-lib.com>

<http://www.404manual.com>

<http://www.luxmanual.com>

<http://aubethermostatmanual.com>

Golf course search by state

<http://golfingnear.com>

Email search by domain

<http://emailbydomain.com>

Auto manuals search

<http://auto.somanuals.com>

TV manuals search

<http://tv.somanuals.com>