

Hamilton Beach®

*Cookie Press and
Cake & Food Decorator*

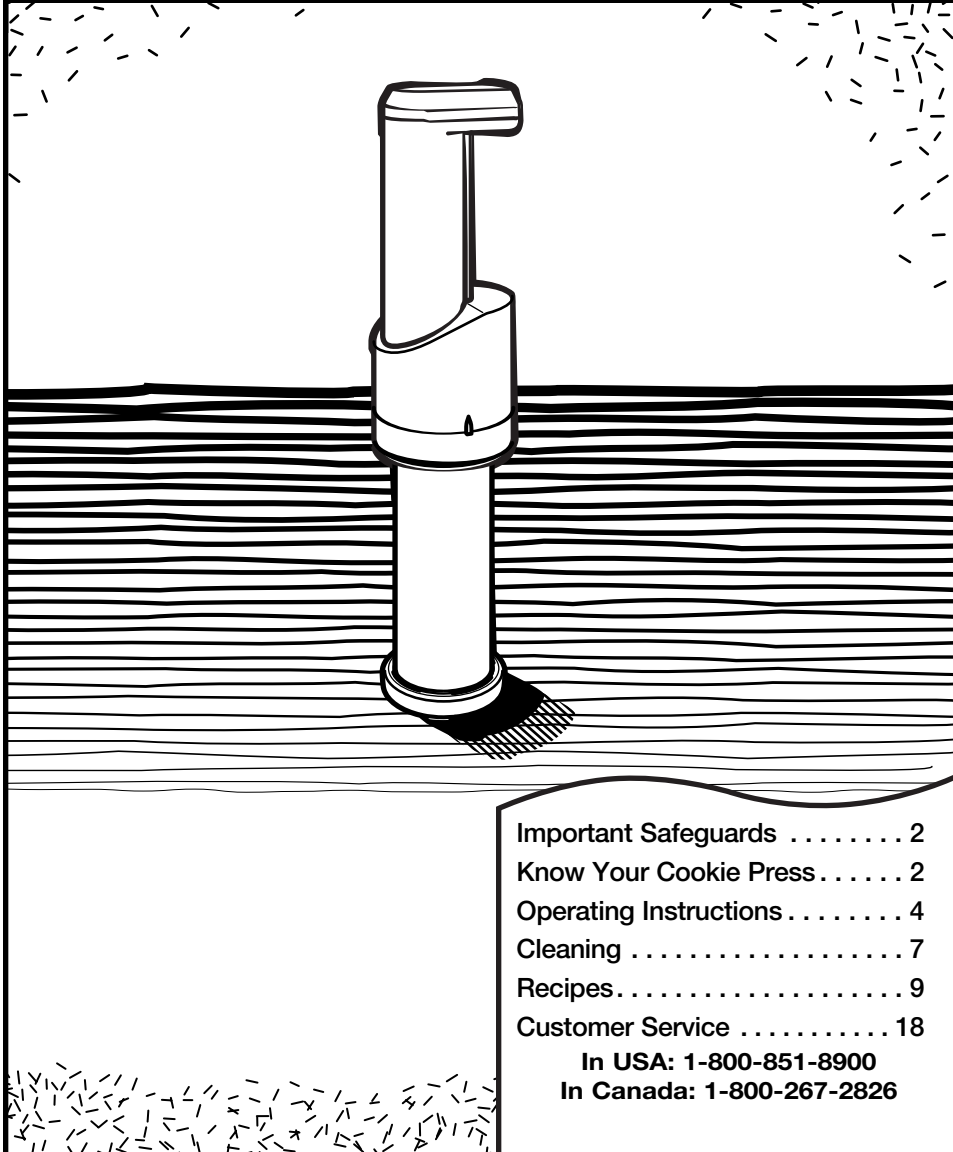

Important Safeguards	2
Know Your Cookie Press	2
Operating Instructions	4
Cleaning	7
Recipes	9
Customer Service	18

**In USA: 1-800-851-8900
In Canada: 1-800-267-2826**

840113300

IMPORTANT SAFEGUARDS

When using this appliance, basic safety precautions should always be followed, including the following:

1. Read all instructions.
2. To prevent damage to the motor, do not immerse motor in water or other liquids.
3. Do not allow dough or batter to run into the hollow shaft, as damage to the motor may occur.
4. Do not operate the cookie press with damaged batteries, motor, or after the appliance malfunctions or is dropped or damaged in any manner.
5. Remove batteries when the cookie press is not in use and before cleaning.
6. Avoid contact with moving parts.
7. Close supervision is necessary when used by or near children.
8. The use of attachments not recommended or sold by Hamilton Beach/Proctor-Silex may damage the cookie press.
9. For household use only.
10. Do not use outdoors.
11. Do not use appliance for other than intended purpose.

SAVE THESE INSTRUCTIONS!

Know Your Cookie Press

Parts and Features

1. Feet
2. Barrel Cap
3. Disc or Tip
4. Pusher Plate
5. Gear
6. Rod
7. Barrel (tube)
8. Hollow Shaft
9. Motor
10. Button/Trigger
11. Battery Cover/Compartment

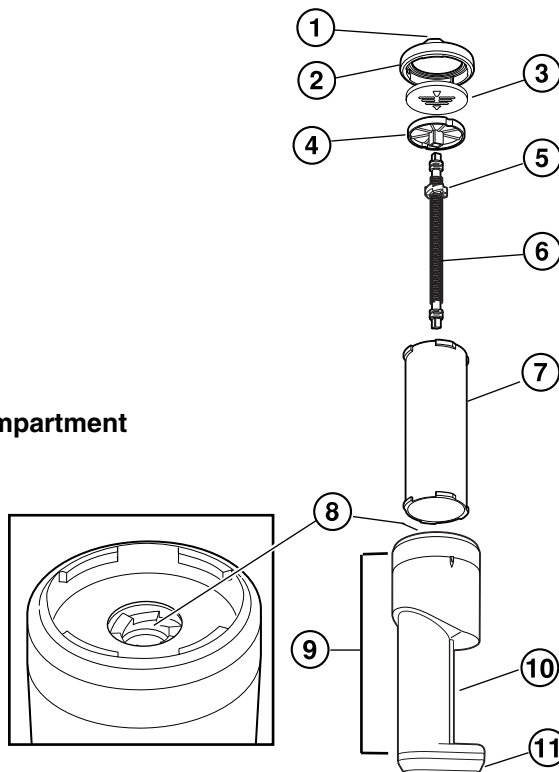

Discs and Tips

Regular Discs

Use discs with stiff dough to prepare cookies, candies, crackers, etc.

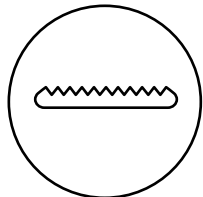

Ribbon

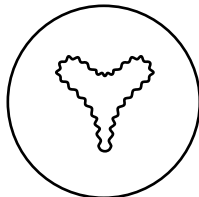

Heart

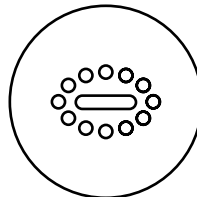

Jewel

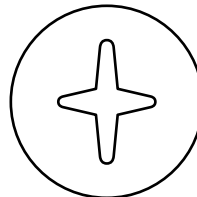

Diamond

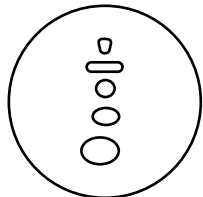

Snowman

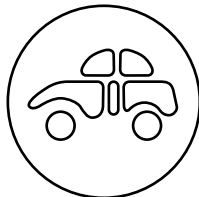

Car

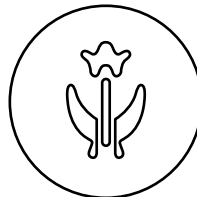

Tulip

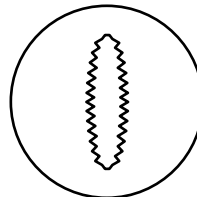

Shell



Tree

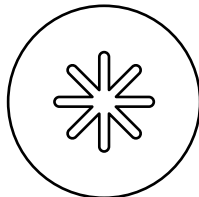

Star

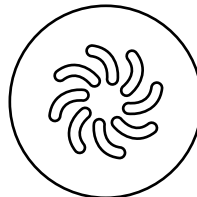

Sparkler



Gingerbread
Man

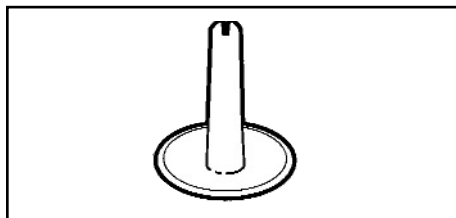

Decorator Tip

Use decorator tip with soft dough to prepare appetizers, candies, and desserts; to fill pasta; and to garnish casseroles and desserts.

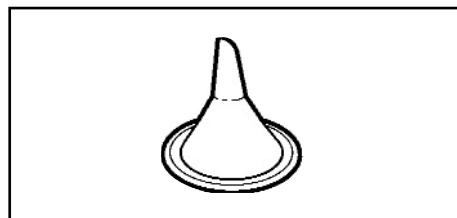

Filler Tip

Use filler tip with thin mixtures to fill pastries.

Operating Instructions

To Assemble and Fill

BEFORE FIRST USE: Wash all parts (except motor) in hot, sudsy water, rinse, and dry thoroughly. Wipe motor with damp cloth and dry thoroughly.

1. Twist the battery cover counterclockwise and lift it to remove. Insert four AA alkaline batteries into the battery compartment (see diagram on unit). Replace the battery cover by placing it off-center (to the right) and twisting to the left until it clicks.

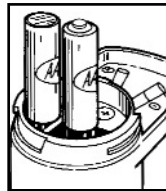
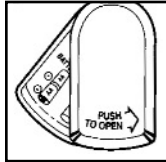

2. Turn the gear on the rod so that one or two threads can be seen above the gear.

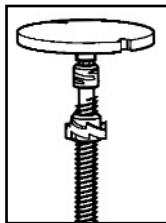
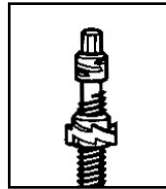

3. Attach the pusher plate to the rod on the end that's nearest the gear.

4. Insert the rod into the hollow shaft.

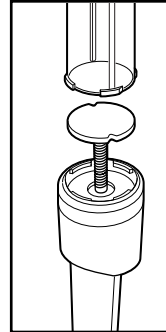

Then, line up the ridges on the inside of the barrel with the notches on the pusher plate. Slide the barrel onto the motor. Turn the barrel clockwise and lock it into place.

5. Fill barrel with desired mixture; press food down lightly to remove air pockets.

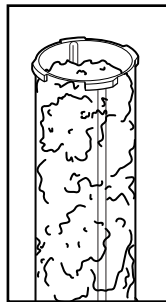

NOTE: Cookie dough must be freshly made. Cookie dough that has been refrigerated overnight is not recommended.

6. Select desired disc or tip and place on filled barrel. Place barrel cap on barrel and turn clockwise to lock into place.

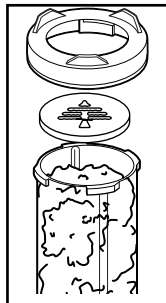

7. With barrel pointing up, squeeze trigger until mixture reaches disc or tip. Release trigger. Turn cookie press over and it is ready to use.

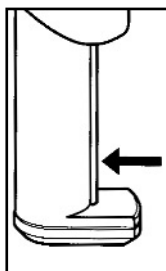

To Refill Barrel:

1. Unit will indicate it is empty by making a clicking noise.
2. Remove barrel cap, disc or tip, and rod/pusher plate.
3. Follow steps 3–7 on pages 4 and 5.

To Use Discs

All Discs except Ribbon Disc

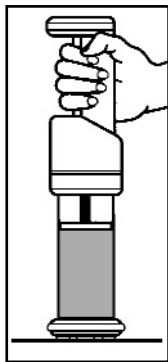

1. When making cookies, mints, etc., line up several ungreased, uncoated (without non-stick surface) baking sheets on work surface.

2. Stand cookie press upright on baking sheet; hold with one hand.

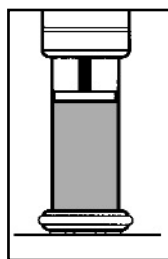

3. Squeeze trigger continuously; touch baking sheet with 3 barrel cap feet for each cookie, mint, etc.

5. Space cookies two inches apart, mints one inch apart on uncoated baking sheet.

NOTE: Cookie/mint shapes and sizes may vary until you develop your own rhythm. As with any new appliance, practice with the cookie press to achieve the best results.

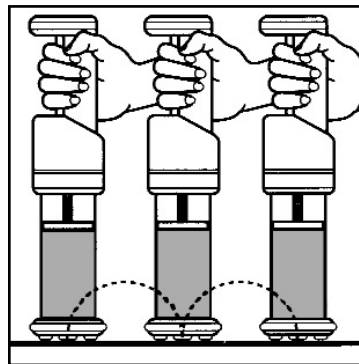

4. To make uniform cookies quickly and easily, establish a rhythm by counting. For example, “one thousand one” – touch baking sheet. “One thousand two” – lift unit and move. “One thousand three” – touch baking sheet, etc.

Alternative method: Squeeze then release trigger for each cookie, mint, etc.; lift and repeat.

Ribbon Disc

1. To make cookies, crackers, etc., line up several ungreased, uncoated baking sheets on work surface.
 - Two-thirds of the way down each strip, release trigger but continue to move unit.
2. Hold cookie press at a 45 degree angle to baking sheet.
 - Touch dough with finger or rubber spatula to break flow of dough. Move unit to start next strip.
3. Squeeze trigger continuously.
 - When dough starts to come through the disc, move the unit to form a 3-inch strip.
4. When baked, remove cookies, crackers, etc. from baking sheet. Place on cooling rack.

To Use Decorator Tip



Mounds: Using a circular motion, make mounds of the desired size and height. Uses: Appetizers, vegetables, desserts, garnishes, candies, etc.



Rosettes: Gradually lift unit straight up until mixture is desired shape and height. Uses: Garnishes, appetizers, candies, etc.

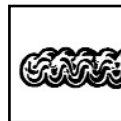

Zigzag lines: Make a series of small "S" movements to desired width. Uses: Appetizers, borders, garnishes, etc.

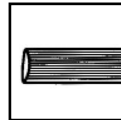

Strips: Move unit in a straight line until mixture is desired length. Uses: Desserts, borders, cookies, pasta. Moving the unit faster produces a thin strip; moving it slower produces a wide strip.

To Use Filler Tip

Use the filler tip to fill foods such as donuts, cream puffs, and éclairs.

1. Arrange foods to be filled on baking sheet.
2. Assemble and fill cookie press with filling mixture.
3. Hold unit parallel to work surface.
4. Holding food in one hand, insert filler tip into one side of food. Squeeze trigger for several seconds, then release. Remove tip from food.

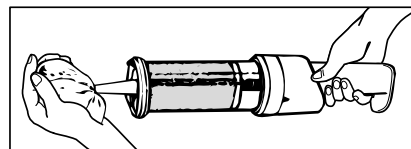

Operating Tips and Tricks

1. Ingredients (onion, green pepper, meat, tuna, seafood, cheese, nuts, hard cooked eggs, cereal, oatmeal, chocolate chips, raisins, etc.) must be **very finely** chopped, minced, or grated before being added to dough or mixtures.
2. Packaged ingredients (chopped nuts, shredded cheese, grated coconut, etc.) must be **very finely** chopped or grated again before using.
3. Measure flour by lightly spooning it into measuring cups, then leveling it off with a straight-edge knife.
4. Sift brown sugar and powdered sugar before measuring to remove lumps and ensure a smooth dough.
5. Dough and mixtures should be pliable before use to extrude easily.
6. If cookie dough is sticky, refrigerate 10-15 minutes before using.
7. Spoon soft mixture into barrel and press food down lightly.
8. Shape stiff dough into small balls, drop into barrel and press dough down lightly to eliminate large air pockets.
9. The cookie press may be operated when barrel is partially filled.
10. Once dough or mixtures have been loaded into barrel, they should be used immediately.
11. Discs may be changed at any time while the barrel is loaded by simply removing the barrel cap. Do not touch trigger while changing discs.
12. The number of cookies, crackers, mints, etc. made from one recipe will depend on the size of the cookies, crackers, etc. pressed. The faster you move the unit, the smaller the cookies.
13. When using the decorator tip, release the trigger before you finish making the desired shape, but continue to move the unit.
14. Stop the flow of dough or mixture from the decorator tip by quickly pushing the decorator tip in and out of the food one time.
15. For best results, use baking sheets that do not have a non-stick surface (uncoated).

Cleaning

1. Disassemble and wash all parts except motor in hot, soapy water. Rinse and dry thoroughly.
 - Do NOT wash in an automatic dishwasher.
 - Use a bottle brush to clean the inside of the barrel.
2. Remove batteries. Wipe motor with a damp cloth or sponge. Dry thoroughly.
3. Do not immerse motor in water. Do not disassemble or attempt to lubricate the motor.
4. It is recommended that the cookie press be stored with the batteries removed.

Questions & Answers

1. How long will the batteries last?

A set of 4 alkaline batteries will last through 35 to 40 regular barrels of stiff dough.

2. How many cookies will one barrel make?

Approximately 4 dozen cookies can be made, depending on the disc and how fast you move the cookie press.

3. Can you use regular AA batteries in the cookie press instead of alkaline batteries?

Regular batteries will not provide as much power and will not last as long as alkaline batteries.

4. Why won't cookies and mints cut off properly?

The dough must be the right consistency – stiff and pliable – not crumbly or very soft. Also, the 3 barrel cap feet must touch the baking sheet in order to form a cookie or mint. As the unit is lifted from the cookie sheet, the flow of dough is cut, forming a cookie or mint. Be sure to use uncoated, ungreased baking sheets.

5. Can you decorate a cake with the cookie press?

The cookie press can be used to make attractive borders, edges, and garnishes on cakes and many other desserts. Stiff icings/frostings work best.

6. Can you use the cookie press when the barrel is not full?

Yes. Be sure to follow the assembly and filling instructions on page 4 and 5.

7. Why won't the cookie press push the dough when the barrel is full?

The gear must be turned so that 1–2 threads are showing on the rod (see step 2 on page 4).

8. Why does the cookie press run backwards?

The batteries are inserted incorrectly. See step 1 on page 4 and the diagram inside the battery compartment for correct battery placement.

Recipes

Appetizers

Helpful Hints

- Vary garnishes using: sprigs of parsley, fresh dill weed, and watercress; pimento or olive slivers; chopped chives or nuts.
- Use vegetables, crackers, fried potato skins, etc. as bases for canapes.
- The following recipes are only a starting point for the wide variety of appetizers that can be prepared. Use these ideas as a guide when creating your own variations.

Crabmeat Canapes

- | | |
|--|--|
| 1 can (6 oz.) crabmeat, drained | 2 teaspoons Worcestershire sauce |
| 1 8 oz. package cream cheese, softened | Canape bases (crackers, cucumber slices, etc.) |
| 2 tablespoons toasted almonds, very finely chopped | |
| 2 teaspoons green onions, very finely chopped | |

Place crabmeat, cream cheese, almonds, onions, and Worcestershire sauce in food processor or blender. Process until mixture is smooth. Assemble and fill cookie press with mixture. Using the decorator tip, make mounds, rosettes, zigzags, or lines on canape bases. Garnish as desired.

Makes 7–8 dozen canapes.

* Cooked lobster, shrimp, or tuna may be substituted for crabmeat.

Deviled Eggs

- | | |
|---|-------------------|
| 12 large eggs, hard-cooked | ¼ teaspoon salt |
| 6 tablespoons mayonnaise | ⅛ teaspoon pepper |
| 1 tablespoon sugar | |
| ½ tablespoon prepared spicy brown mustard | |

Cut eggs in half lengthwise. Remove yolks and place in food processor. Process until finely chopped. Add mayonnaise, sugar, mustard, salt, and pepper. Process until smooth. Arrange egg whites on serving plate or tray. Blot tops of eggs with paper towel to remove any excess moisture. Assemble and fill cookie press with yolk mixture. Using decorator tip, fill egg whites with mixture. Garnish as desired.

Makes 24 deviled eggs.

Cheddar Crackers

½ cup butter or margarine, softened	2½ cups all purpose flour
½ cup vegetable shortening	1 tablespoon salt
1 pound sharp cheddar cheese, finely grated	1 tablespoon dry mustard
	⅛ teaspoon cayenne pepper

Place butter and shortening in large mixing bowl. Cream together on medium high speed. Add cheese and mix well using medium speed. Combine flour, salt, mustard, and cayenne in separate bowl. Add to the cheese mixture in three (3) additions, mixing well after each addition. Use low speed. Assemble and fill cookie press with dough; use ribbon disc. Make 3 inch ribbons on greased, uncoated baking sheet. Bake at 350°F for 10-12 minutes, or until edges are just starting to turn brown. Carefully remove from baking sheet. Cool on wire rack. Sprinkle with paprika if desired.

Makes 8-9 dozen crackers.

Entrees

Helpful Hints

- Mashed potatoes make attractive borders or toppings for meat, seafood, or vegetable casseroles; stews; or shepherd's pie. Prepare mashed potatoes as usual, making sure they have a smooth thick consistency. Two cups will fill barrel. Use decorator tip.
- Butter rosettes are an elegant addition to dinner parties and buffets. They also add an artistic touch to pancakes and waffles at a festive brunch.
- Use whipped butter or margarine directly from the refrigerator; 8 oz. will fill barrel. Refrigerate or freeze rosettes until serving.
- Cream cheese rosettes are an attractive replacement for butter on baked potatoes and other vegetables.
- Whip cream cheese until fluffy; 12 oz. fills barrel. Use decorator tip.

Three Cheese Stuffed Shells

1 package (12 oz.) jumbo shell pasta (about 30), cooked	½ teaspoon salt
2 containers (15 oz. each) ricotta cheese	½ teaspoon pepper
1 package (8 oz.) mozzarella cheese, finely shredded	½ teaspoon basil
½ cup grated Parmesan cheese	¼ teaspoon garlic powder
2 eggs, slightly beaten	1 jar (31-¾ oz.) spaghetti sauce
	Grated Parmesan cheese

Combine ricotta, mozzarella, and Parmesan cheese, eggs, salt, pepper, basil, and garlic powder in a large mixing bowl. Mix until well blended. Assemble and fill cookie press with cheese mixture; use decorator tip. Fill shells. Pour thin layer of spaghetti sauce into a 13 x 9 inch baking pan. Arrange filled shells in a single layer over sauce. Top with remaining sauce. Sprinkle with Parmesan cheese. Bake at 350°F for 30-40 minutes.

Makes 30 shells (10 servings)

Chicken Manicotti

8 manicotti tubes, cooked	2 eggs, slightly beaten
¼ cup butter or margarine	1 teaspoon salt
½ pound mushrooms, sliced	1 teaspoon thyme
2 cups cooked chicken, finely chopped	1 teaspoon Worcestershire sauce
½ cup parsley, finely minced	⅛ teaspoon pepper
½ cup fresh white bread crumbs	3 cups tomato sauce
¼ cup onion, finely chopped	Grated Parmesan cheese

Place butter in large fry pan; melt over medium heat. Add mushrooms, saute 5 minutes. Place in food processor or blender; process until smooth. Combine mushrooms, chicken, parsley, bread crumbs, onion, eggs, salt, thyme, Worcestershire sauce and pepper in large mixing bowl. Mix until well blended. Assemble and fill cookie press with mixture; use decorator tip. Insert tip into one end of manicotti tube; squeeze trigger several times; at same time pull unit back out of manicotti tube. When one end of manicotti tube is filled, turn tube around and fill other end. Pour thin layer of tomato sauce into 13 x 9 inch baking pan. Arrange filled manicotti tubes in single layer over sauce. Top with remaining sauce. Sprinkle with Parmesan cheese. Bake at 350°F for 30-40 minutes.

Makes 8 manicotti (4 servings)

Twice-Baked Potatoes

8 medium (6-8 oz. each) Russet potatoes, washed and dried	1 teaspoon salt
¼ cup butter or margarine	⅛ teaspoon pepper
	¼-½ cup milk

Prick potato skins with fork. Bake at 425°F for 60 minutes or until fork tender. With sharp knife, slice lengthwise to remove top fourth from each potato. Use spoon to carefully scoop out potatoes to form 6 shells, set aside. Scrape potato from top quarter, then discard top. Place shells on ungreased baking sheet. Place potatoes, butter, salt, and pepper in large mixing bowl. Beat until fluffy on high speed. Add ¼ cup milk, beating until smooth. If potatoes are too stiff, add remaining ¼ cup milk. Mixture should be smooth. Assemble and fill cookie press with potato mixture; use decorator tip. To fill shells, hold unit above potato shell; squeeze trigger continuously while moving the unit around shell to fill. Repeat with remaining shells. Sprinkle potatoes with paprika. Bake at 425°F for 10-12 minutes or until tops are golden.

Makes 6 potatoes (6 servings).

Variations:

Bacon/Onion: Add 4 oz. bacon, cooked, drained and finely crumbled; 1 tablespoon onions finely minced.

Cheese: Add 4 oz. sharp Cheddar cheese, finely grated; ¼ cup parsley, finely chopped or 1 tablespoon caraway seeds.

Sour Cream/Chives: Substitute 1/2 cup sour cream for butter and milk; add 2 tablespoons finely chopped chives.

Cookies

Helpful Hints

- Decorate cookies **before** baking by brushing them with slightly beaten egg white and adding one of the following:
 1. Sprinkle with white or colored granulated sugar.
 2. Place a nut or chocolate chip on center of cookie.
 3. Decorate with small pieces of candied fruit, chopped nuts, coconut or chocolate sprinkles.
- When using this egg white glaze, you may need to increase baking time about 1 minute.
- Decorate cookies **after** baking by:
 1. Placing a small amount of jam or color frosting on top.
 2. Brushing tops with sugar glaze then sprinkling with chopped nuts, coconut, decorative candy bits, etc.
 3. Rolling warm cookies in powdered sugar.
 4. Dipping half of cookie in melted semi-sweet chocolate then sprinkling with ground nuts.
 5. Brushing with thin glaze. Combine 1 cup powdered sugar, 4-5 teaspoons hot milk, and 1/2 teaspoon vanilla. Mix well.
 - Make sandwich cookies. Assemble and fill cookie press with desired frosting; use decorator tip. Make a small rosette in center of half of the cookie and press together gently.

Basic Spritz Cookies

1/2 cup butter or margarine, softened	2 teaspoons vanilla
1/2 cup vegetable shortening	2 cups all-purpose flour
3/4 cup granulated sugar	1/4 teaspoon baking powder
1 large egg	1/4 teaspoon salt

Place butter and shortening in large mixing bowl. Cream together on medium high speed. Add sugar gradually. Beat until light and fluffy, about 5 minutes. Add egg and vanilla; mix well using medium speed. Combine flour, baking powder and salt in separate bowl. Add to butter/sugar mixture in three (3) addition. Dough will be stiff. Assemble and fill cookie press with dough; using desired disc. Press cookies on ungreased, uncoated baking sheet. Bake at 375°F 10-12 minutes or until lightly brown around the edges. Do not overbake.

Makes 6-7 dozen cookies.

Variations:

This recipe may varied in flavor and color by using different spices and/or extracts, or by adding food coloring to the dough in Step 3. The following variations will give you a good start.

Orange: Substitute 2 tablespoons orange extract for the vanilla; add 1 tablespoon **finely** grated orange peel.

Raspberry-Nut: Substitute 1 1/2 teaspoons coconut extract for the vanilla; 2 tablespoons **seedless** red raspberry jam. Sprinkle with chopped nuts before baking.

Gingerbread Cookies

½ cup brown sugar	1 teaspoon ginger
½ cup shortening	½ teaspoon baking soda
¼ cup light molasses	½ teaspoon ground cloves
1 egg	½ teaspoon nutmeg
2 cups all-purpose flour	¼ teaspoon mace
1½ teaspoons cinnamon	⅛ teaspoon salt
1 teaspoon baking powder	

Place brown sugar and shortening in large mixing bowl. Beat on medium speed until thoroughly creamed. Add molasses and egg to sugar/shortening mixture, beat until well blended. Combine flour, cinnamon, baking soda, baking powder, ginger, cloves, nutmeg, mace, and salt in a separate bowl. Gradually add flour mixture to sugar/shortening mixture, beat until thoroughly blended. Assemble and fill cookie press with dough. Use gingerbread man disc. Press cookies on ungreased, uncoated baking sheet. Bake at 350°F for 10-12 minutes.

Makes 5-6 dozen cookies.

Applesauce Cookies

½ cup butter or margarine, softened	3½ cups all-purpose flour
½ cup granulated sugar	1 teaspoon baking soda
1 cup brown sugar, firmly packed	1 teaspoon cinnamon
1 large egg	1½ teaspoons pumpkin pie spice
1 cup unsweetened applesauce	½ teaspoon salt
½ cup wheat germ	

Place butter in large mixing bowl and cream thoroughly on medium high speed. Add sugars gradually. Beat until light and fluffy. Add egg, applesauce, and wheat germ. mix well using medium speed. Combine flour, baking soda, cinnamon, pumpkin pie spice, and salt in a separate bowl. Add to applesauce mixture in three (3) additions; mixing well after each addition. Dough will be soft. Assemble and fill cookie press with dough; using decorator tip. Make 1½ inch mounds, 2 inches apart on ungreased, uncoated baking sheet. Bake at 400°F for 9-11 minutes or until lightly browned around the edges. Do not overbake. Brush with a thin glaze.

Makes 6-7 dozen cookies.

Sugar & Spice

½ cup butter or margarine, softened	1 teaspoon baking powder
½ cup shortening	4 cups flour
¾ cup sugar	½ teaspoon cinnamon
¾ cup brown sugar	½ teaspoon nutmeg
3 eggs	¼ teaspoon allspice
1 teaspoon vanilla	⅛ teaspoon ground cloves
3 tablespoons milk	Pinch of salt

Place butter, shortening, and sugars in large mixing bowl. Cream together until fluffy. Add eggs, vanilla, and milk. Beat until mixed. Combine baking powder, flour, cinnamon, nutmeg, allspice, cloves, and salt. Gradually add to better/sugar mixture. Beat until mixed. Assemble and fill cookie press with dough; use selected discs. Press cookies on ungreased, uncoated baking sheet. Bake at 325°F for 12 to 15 minutes.

Makes 10 dozen cookies.

Desserts

Helpful Hints

- For a festive touch, garnish desserts, such as sheet cakes, cold souffles, tortes, cream pies, puddings, shortcakes, gelatin, cobblers, fruit cups, etc., with sweetened whipped cream.
- Sweetened whipped cream cheese rosettes and borders are attractive when used to decorate desserts, such as carrot cake. Whip cream cheese until fluffy; add sugar; 12 oz. fills barrel.
- Mints make attractive cake decorations.
- Use the above ideas as guides when creating your own garnishes.

Frozen Yogurt Pie

2 containers (8 oz. each) vanilla yogurt	1 8-inch graham cracker or cookie pie crust
1 container (8 oz.) whipped topping	

Place yogurt in large mixing bowl. Lightly fold in whipped topping. Assemble and fill cookie press with yogurt mixture; use decorator tip. Spoon remaining yogurt mixture into pie crust; make surface smooth. Decorate pie using cookie press. Freeze until firm. Remove pie from freezer 10-15 minutes before serving.

Makes 1 pie (8 servings).

Variations:

Berry: Substitute strawberry, raspberry, or other berry yogurt for vanilla yogurt.

Lemon: Substitute lemon yogurt for vanilla yogurt; add 1 tablespoon finely grated lemon peel to yogurt.

Cream Puffs

1 cup water	1 cup all-purpose flour
½ cup butter or margarine	4 large eggs
¼ teaspoon salt	

Place water, butter, and salt in medium saucepan; bring to boil; remove from heat. Stir in flour all at once. Beat well until mixture leaves the sides of the pan. Cool 1 minute. Add eggs, one at a time, beating well after each addition. Mixture should be smooth and glossy. Assemble and fill cookie press with cream puff mixture; use decorator tip. Make 1 1/2 inch mounds, 2 inches apart on greased baking sheet. Bake at 450°F for 15 minutes. Reduce to 350°F and continue to bake for 30 minutes or until puffs are golden brown with dry, rigid sides. Make a slit in the side of puff with a small sharp knife. Cool on wire rack. Fill centers per directions.

Makes 12 large cream puffs.

Cream Puff Variation:

Miniature Cream Puffs:

Make 1-inch mounds, 2 inches apart, on greased baking sheet. Bake at 450°F for 15 minutes; reduce to 350°F and continue baking 10 minutes or until puffs are golden brown with dry, rigid sides. Fill centers with vanilla cream or cut tops off and fill with meat, cheese or seafood fillings.

Makes 42 miniature cream puffs.

Eclairs

Prepare cream puff mixture. Using decorator tip, make 3-inch long strips, 2 inches apart, on greased baking sheet. Bake at 450°F for 15 minutes; reduce to 350°F and continue baking for 30 minutes or until eclairs are golden brown with dry, rigid sides. Make a slit in the side of each eclair with a small, sharp knife. Cool on wire rack. Fill centers. Spread tops with chocolate or vanilla frosting.

Makes 12-15 eclairs.

Vanilla Cream

1 cup sugar	4 egg yolks, slightly beaten
6 tablespoons all-purpose flour	¼ cup butter or margarine
¼ teaspoon salt	1 tablespoon vanilla
1½ cups milk	½ cup heavy cream, whipped

Combine sugar, flour and salt in medium saucepan. Stir in milk. Cook, stirring constantly, over low heat until mixture thickens (about 5 minutes). Add egg yolks and cook, stirring constantly, 3 minutes. Do not allow to boil. Remove from heat, stir in butter and vanilla. Chill. Fold in whipped cream. Assemble and fill cookie press with vanilla cream; use filler tip. Fill cream puffs, miniature puffs or eclairs.

Makes 3 cups vanilla cream; fills about 12 medium puffs or eclairs, or about 36 miniature puffs.

Candy

Helpful Hints

- Flavors may be varied by substituting any liqueur, cordial or extract.
- Vary mint colors by using different foods colors. For example: Pink: 2-3 drops red. Pale Yellow: 4-5 drops yellow.
- Chocolate Kisses may be held several weeks by storing in covered plastic containers. Place waxed paper on bottom of container; arrange single layer of candies in container; cover with another sheet of waxed paper. Repeat until container is filled. Store in cool, dry place. Do not refrigerate.

Chocolate Kisses

- | | |
|---|---|
| 1 package (12 oz.) semisweet chocolate pieces | 1 can (14 oz.) sweetened condensed milk |
| ¼ cup almond flavored liqueur | Crystallized lilacs (optional) |
| ⅛ teaspoon salt | |

Melt chocolate pieces in double boiler. Remove from heat. Stir in liqueur, salt and sweetened condensed milk in one addition. Beat until smooth; cover with plastic wrap. Let stand at room temperature overnight. Assemble and fill cookie press with chocolate mixture; use decorator tip. On waxed-paper-lined baking sheet, make mounds 1 inch in diameter and 3/4 inch in height. Top with crystallized lilacs, if desired. Allow to stand several hours or overnight, until Kisses can be easily removed from baking sheets with spatula.

Makes 7 dozen Kisses.

Variations:

Chocolate stars: Make rosettes instead of mounds.

Mints

- | | |
|--|-------------------------------|
| 1 package (3 oz.) cream cheese, softened | ½ teaspoon peppermint extract |
| 1 tablespoon light corn syrup | 1-2 drops green food color |
| | 3-4 cups powdered sugar |

Place cream cheese, corn syrup, extract and food color in large mixing bowl. Cream thoroughly on medium high speed. Add sugar gradually. Beat until thoroughly mixed. Dough will be smooth. Form into a ball. Assemble and fill cookie press with mint dough; use desired disc. Make mints on ungreased, uncoated baking sheet. Allow mints to "firm up" (about 20-30 minutes) before attempting to arrange on plate or to serve.

Makes 5-6 dozen mints.

Frostings

Orange Frosting

½ cup butter or margarine, softened	2 tablespoons freshly grated orange peel
4 cups sifted powdered sugar	1 tablespoon orange juice
2 tablespoons sour cream	
⅛ teaspoon salt	

Place butter in large mixing bowl. Cream thoroughly on medium high speed. Add sugar, sour cream, orange peel, orange juice and salt. Beat until smooth and creamy. NOTE: Add extra orange juice, if frosting is too stiff. Assemble and fill cookie press; use decorator tip.

Makes 3 cups frosting.

Variations:

Chocolate: Increase powdered sugar to 4½ cups and sour cream to 6 tablespoons. Add three (3) 1 oz. squares unsweetened chocolate, melted. Omit orange peel and juice.

Professional Frosting

2 cups solid vegetable shortening	2 teaspoons vanilla
½ cup milk	Food color (optional)
2 pounds powdered sugar	

Place vegetable shortening in large mixing bowl. Beat on high speed 3 minutes until creamy. Add milk; beat on low speed, until well blended. Gradually add powdered sugar. Beat on high speed 1 minute. Add vanilla and food color. Beat on high speed 1 minute, until light and fluffy. Assemble and fill cookie press with frosting; use decorator tip.

Makes 5 cups frosting.

Convenience Foods

Helpful Hints

- To save time, use one of the many prepared cheese or meat spreads when making appetizers.
- Create a professional-looking cake in minutes by decorating any cake with ready-made frosting.
- Defrost whipped topping in refrigerator; 3-4 ounces of topping fills barrel. Use to decorate a wide variety of desserts.
- Make quick sugar cookies in fun shapes by using "commercially prepared" refrigerated dough or sugar cookie mixes (omit water).
- Fill donuts with seedless jelly or vanilla cream for a special breakfast treat. Use filler tip.

Customer Service

If you have a question about your cookie press, call our toll-free customer service number. Before calling, please note the model and type numbers and fill in that information below. These numbers can be found on the base of the motor, around the shaft. This information will help us answer your question much more quickly.

MODEL: _____ **TYPE:** _____

LIMITED WARRANTY

This product is warranted to be free from defects in material and workmanship for a period of two (2) years for Hamilton Beach Portfolio products or one (1) year for Hamilton Beach products from the date of original purchase, except as noted below. During this period, we will repair or replace this product, at our option, at no cost. THE FOREGOING WARRANTY IS IN LIEU OF ANY OTHER WARRANTY, WHETHER EXPRESS OR IMPLIED, WRITTEN OR ORAL INCLUDING ANY WARRANTY OF MERCHANTABILITY OR FITNESS FOR A PARTICULAR PURPOSE. ANY LIABILITY IS EXPRESSLY LIMITED TO AN AMOUNT EQUAL TO THE PURCHASE PRICE PAID, AND ALL CLAIMS FOR SPECIAL, INCIDENTAL AND CONSEQUENTIAL DAMAGES ARE HEREBY EXCLUDED. There is no warranty with respect to the following, which may be supplied with this product: glass parts, glass containers, cutter/strainer, blades, and/or agitators. This warranty extends only to the original consumer purchaser and does not cover a defect resulting from abuse, misuse, neglect, use for commercial purposes, or any use not in conformity with the printed directions. This warranty gives you specific legal rights, and you may also have other legal rights which vary from state to state, or province to province. Some states or provinces do not allow limitations on implied warranties or special, incidental or consequential damages, so the foregoing limitations may not apply to you.

If you have a claim under this warranty, DO NOT RETURN THE APPLIANCE TO THE STORE! Please call our CUSTOMER SERVICE NUMBER. (For faster service please have model, series, and type numbers ready for operator to assist you.)

CUSTOMER SERVICE NUMBERS

In the U.S. 1-800-851-8900

In Canada 1-800-267-2826

Web site address: www.hamiltonbeach.com

KEEP THESE NUMBERS FOR FUTURE REFERENCE!

HAMILTON BEACH ♦ PROCTOR-SILEX, INC.

263 Yadkin Road Southern Pines, North Carolina 28387

840113300

PROCTOR-SILEX CANADA, INC.

Picton, Ontario K0K 2T0

Web site address: www.hamiltonbeach.com

3/03

Free Manuals Download Website

<http://myh66.com>

<http://usermanuals.us>

<http://www.somanuals.com>

<http://www.4manuals.cc>

<http://www.manual-lib.com>

<http://www.404manual.com>

<http://www.luxmanual.com>

<http://aubethermostatmanual.com>

Golf course search by state

<http://golfingnear.com>

Email search by domain

<http://emailbydomain.com>

Auto manuals search

<http://auto.somanuals.com>

TV manuals search

<http://tv.somanuals.com>