

Visor™ Handheld User Guide

Macintosh Edition



Copyright

Copyright © 2000 Handspring, Inc. All rights reserved. Portions copyright © 1998-2000 Palm, Inc. or its subsidiaries. All rights reserved. Handspring, Springboard, Visor, the Handspring logo, and the Springboard logo are trademarks of Handspring, Inc., and may be registered in some jurisdictions. Palm Computing, Palm OS, Graffiti, and HotSync are registered trademarks, and the HotSync logo, Palm, and the Palm Computing Platform logo, are trademarks of Palm, Inc., or its subsidiaries. All other trademarks are the property of their respective owners.

Disclaimer and limitation of liability

Handspring, Inc. and its suppliers assume no responsibility for any damage or loss resulting from the use of this handbook.

Handspring, Inc. and its suppliers assume no responsibility for any loss or claims by third parties which may arise through the use of this software. Handspring, Inc. and its suppliers assume no responsibility for any damage or loss caused by deletion of data as a result of malfunction, dead battery, or repairs. Be sure to make backup copies of all important data on other media to protect against data loss.

Important: Please read the Handspring End User Software License Agreement before using the accompanying software program(s). Using any part of the software indicates that you accept the terms of the Handspring End User Software License Agreement.

Software download available

Palm™ Desktop software is supplied on a CD-ROM disc. If you do not have access to a CD-ROM drive for your computer, you can download the Palm Desktop software from www.handspring.com.

Contents

About This Guide	1
Chapter 1: Introduction to Your Visor Handheld	3
Getting to know your Visor handheld	3
What is a Visor handheld?	3
System requirements	4
Upgrade information	4
Visor components	6
Installing the batteries	10
Tapping and typing	11
Tap with the stylus to get things done	11
Elements of the handheld interface	12
Opening applications	13
Using menus	14
Four ways to enter data	17
Customizing your handheld	20
Palm Desktop software	22
Connecting the cradle	22
Using your handheld with another PIM	24
Installing a Springboard module	24
Chapter 2: Entering Data in Your Visor Handheld	25
Using Graffiti writing to enter data	25
Writing Graffiti characters	25
Graffiti tips	27
The Graffiti alphabet	28
Writing capital letters	29
Writing numbers	29
Graffiti numbers	30
Writing punctuation marks	30
Writing symbols and extended characters	31
Writing accented characters	32
Accent strokes	32
Additional non-English characters	32
Navigation strokes	33
Graffiti ShortCuts	33
Using the onscreen keyboard	34
Using your computer keyboard	35
Importing data	35
Using an external keyboard	36

Chapter 3: Managing Your Applications.....	37
Using the Applications Launcher.....	37
Selecting applications	37
Switching between applications	37
Categorizing applications	37
Changing the Applications Launcher display	38
Choosing preferences.....	39
Installing and removing applications.....	40
Installing add-on applications	40
Installing games	42
Removing applications	42
Removing Palm Desktop software	43
Security.....	44
Assigning a password	44
Changing or deleting a password	45
Locking your handheld	46
Recovering from a forgotten password	47
Chapter 4: Overview of Basic Applications.....	49
Date Book.....	50
Date Book Plus	51
Address	52
To Do List.....	53
Memo Pad.....	54
Calculator.....	55
CityTime.....	56
Expense.....	57
Chapter 5: Common Tasks	59
Creating records.....	59
Editing records	60
Entering text	60
Edit menu	60
Deleting records.....	62
Other ways to delete records	62
Purging records.....	63
Exchanging and updating data: HotSync operations.....	64
Performing a HotSync operation for the first time	64
Categorizing records	66
System-defined and user-defined categories	66
Finding records	69
Looking up Address records	70
Using Find	71
Using Phone Lookup	72

Sorting lists of records	74
Making records private	75
Hiding and masking private records	75
Attaching notes	77
Choosing fonts	78

Chapter 6: Application Specific Tasks79

Date Book	80
Scheduling an event	80
Rescheduling an event	84
Setting an alarm for an event	84
Scheduling repeating or continuous events	85
Changing the Date Book view	88
Working in Week View	88
Working in Month View	90
Working in Agenda view	90
Spotting event conflicts	91
Date Book menus	92
Date Book Plus.....	95
Working in Week View with Text	95
Working in Year View	96
Working in List View	97
Working with floating events	97
Working with To Do items	99
Using the Daily Journal	100
Using templates	101
Using snooze alarms	102
Selecting the default Date Book	102
Date Book Plus menus	102
Address.....	111
Creating an Address entry	111
Duplicating an entry	112
Selecting types of phone numbers	113
Changing Address Entry details	113
Address menus	114
To Do List	116
Setting priority	116
Checking off a To Do item	117
Changing To Do item details	117
Setting a due date	118
To Do Show Options	119
To Do List menus	120
Memo Pad.....	121
Reviewing memos	121

Memo Pad menus	122
Calculator.....	123
Selecting the Calculator mode	123
Using the Basic Calculator buttons	123
Displaying Recent Calculations	124
Using the Advanced Calculator mode	124
Using the Advanced Calculator buttons	125
Creating a custom view	134
Calculator menus	135
CityTime.....	136
Setting your home city	136
Selecting remote cities	137
Adding cities	137
CityTime menus	138
Expense.....	139
Changing the date of an Expense item	140
Entering receipt details	140
Customizing the Currency pick list	142
Show Options	143
Expense menus	144

Chapter 7: Communicating Using Your Handheld.....145

Managing desktop E-Mail away from your desk	145
Setting up Mail on the desktop	146
Synchronizing Mail with your E-Mail application	146
Opening the Mail application on your handheld	146
Viewing e-mail items	146
Creating e-mail items	148
Looking up an address	150
Adding details to e-mail items	151
Storing e-mail to be sent later	154
Editing unsent e-mail	154
Draft e-mail	155
Filing e-mail	156
Deleting e-mail	157
Removing e-mail from the Deleted folder	157
Purging deleted e-mail	158
Message list options	158
HotSync options	160
Creating special filters	161
Truncating e-mail items	165
Mail menus	166
Beaming information.....	167

Chapter 8: Advanced HotSync® Operations	171
Selecting HotSync setup options	171
Customizing HotSync application settings	174
IR HotSync operations	175
Preparing your computer for infrared communication	175
Configuring HotSync Manager for infrared communication	176
Performing an IR HotSync operation	177
Returning to cradle HotSync operations	177
Conducting a HotSync operation via modem.....	178
Preparing your computer	178
Preparing your handheld	180
Selecting the conduits for a modem HotSync operation	181
Performing a HotSync operation via a modem	182
Creating a user profile	182
Chapter 9: Setting Preferences for Your Handheld	185
Viewing preferences	185
Buttons preferences.....	186
Pen preferences	186
HotSync buttons preferences	188
Connection preferences	188
Connection Types	189
Setting modem configurations	189
Digitizer preferences.....	192
Formats preferences	192
Country default	192
Time, date, week start, and numbers formats	193
General preferences.....	193
Auto-off delay	194
System, alarm, and game sounds	194
Network preferences and TCP/IP software.....	195
Selecting a service	195
Entering a user name	196
Entering a password	197
Selecting a connection	198
Adding telephone settings	198
Connecting to your service	201
Creating additional service templates	202
Adding detailed information to a service template	202
Creating a login script	205
Deleting a service template	207
Network preferences menu commands	208
TCP/IP troubleshooting	208
Owner preferences	209

ShortCuts preferences	210
Creating a ShortCut	210
Editing a ShortCut	211
Deleting a ShortCut	211
Appendix A: Maintaining Your Handheld	213
Caring for your handheld.....	213
Battery considerations.....	214
Resetting your handheld	215
Performing a soft reset	215
Performing a warm reset	216
Performing a hard reset	216
Appendix B: Troubleshooting Tips.....	219
Operating problems.....	220
Tapping and writing problems.....	221
Application problems.....	222
HotSync problems	223
Beaming problems	227
Password problems	228
Technical support	229
Appendix C: Non-ASCII Characters for Login Scripts.....	231
Use of ^char	231
Carriage return and line feed	231
Literal characters.....	232
Warranty and Other Product Information	233
Handspring, Inc. Limited Warranty	233
Handspring, Inc. End User Software License Agreement	236
GNU Library General Public License	238
FCC Statement.....	245
Canadian RFI Statement	245
Acknowledgments.....	246
Index	247

About This Guide

Welcome to the Visor™ handheld computer. This guide is designed to help you get up and running quickly on your handheld. It describes all you need to know about how to use your Visor handheld and the applications that come with it.

It walks you through:

- Locating all the parts of your handheld
- Viewing and entering data
- Using your handheld with your computer
- Personalizing your handheld with your own preference settings

After you become familiar with the basic functionality of your Visor handheld, you can use the rest of this guide as a reference for less common tasks, for maintaining your Visor handheld, and also as a source of information if you have problems operating it.

Chapter 1

Introduction to Your Visor Handheld

This chapter explains the physical buttons and controls on your Visor handheld computer, how to use your Visor handheld for the first time, and how to use HotSync® technology to synchronize your Visor handheld and Palm™ Desktop software.

Getting to know your Visor handheld

What is a Visor handheld?

With your Visor handheld, you will no longer have trouble getting to meetings and appointments on time, remembering people's names and personal details, or keeping track of all the items on your to do list. The Visor handheld can help you improve your track record in all these areas, both at work and at home.

You can enter all your schedule details in Date Book Plus so you can view them by the day, week, month, year, or in list format; you can even set an alarm to remind you of important meetings. Keep all your contact names, addresses, phone numbers, and other details in Address, so you can find them as soon as you need them. Add your tasks to To Do list, prioritize them so you don't overlook them, and assign them a due date.

To make sure you don't lose any of this important information, you can synchronize your data with Palm Desktop software on your computer so you always have a backup copy. You can set different levels of security for your Visor handheld so unauthorized eyes cannot view your data.

When you are out of the office, track your expenses for your expense reports. You can write, edit, and view your e-mail, and then synchronize your e-mail with your desktop E-Mail application when you return to your office.

System requirements

To install and operate Palm Desktop software, your computer system must meet the following requirements:

Minimum requirements

- MacOS 8.1 or later (for USB cradle)
--or--
MacOS 7.53 or later (for serial cradle)
- Apple Macintosh or compatible computer with a PowerPC processor
- 8 MB RAM (memory) *minimum*, 16 MB recommended
- 25 MB available hard disk space
- VGA monitor or better
- CD-ROM drive
- Mouse
- USB port (for USB cradle)
Serial port (for serial cradle)

Optional equipment

- Modem (such as a Springboard™ modem)
- Springboard expansion modules

Upgrade information

If you already own a Palm OS® handheld, Handspring recommends that you install the version of Palm Desktop software that comes with your Visor handheld into the same folder as your current Palm Desktop software. When you install the new version in the same folder as the previous version, all your data is preserved. If you use another personal information manager (PIM), you still need to install Palm Desktop software in order to update the HotSync Manager on your computer.

You perform HotSync operations in exactly the same way, so you can quickly synchronize your old data with your new handheld.

To upgrade:

1. Synchronize your old handheld with your old Palm Desktop software. This ensures that the latest information from your handheld is on your desktop computer.

2. (Optional) To ensure against any data loss, go to the folder that stores Palm Desktop software, copy your user name folder, and store the copy outside the Palm Desktop software folder.
3. Follow the installation instructions in “Installing Palm Desktop software” later in this chapter. Be sure to install the new software in the same folder as the old software.
4. To prepare for the first HotSync operation that synchronizes your new handheld with your new Palm Desktop software, open Palm Desktop software, open the HotSync menu, and then choose Conduit Settings.

Note: Be sure your user name appears in the box at the top of the Conduit Settings dialog box. If not, select your user name.

5. For all conduits, click Conduit Settings and select the option Macintosh overwrites handheld. Then click OK. See “Customizing HotSync application settings” in Chapter 8 for more information.
6. Place your new handheld in the cradle and press the HotSync button. If the User dialog box appears, select your user name.
7. Compare the applications on your old and new handhelds.
8. Beam any third party applications that did not transfer from your old handheld to your Visor handheld, or install them from the original files.

Each handheld must have a unique name

After you complete the upgrade process described above, you have two handhelds with the same name. This is an undesirable situation. Each handheld must have a unique name in order to prevent unexpected results during HotSync operations and other complications.

We strongly recommend that you perform a hard reset on your old handheld. See “Performing a hard reset” in Appendix A for details.

A hard reset not only erases all data from the old handheld; it also erases the name and makes that handheld a clean slate, ready to receive a new name. The next time you perform a HotSync operation with this old handheld, you are asked to give it a name. Be sure to give it a unique name.

Visor components

Locating front panel controls

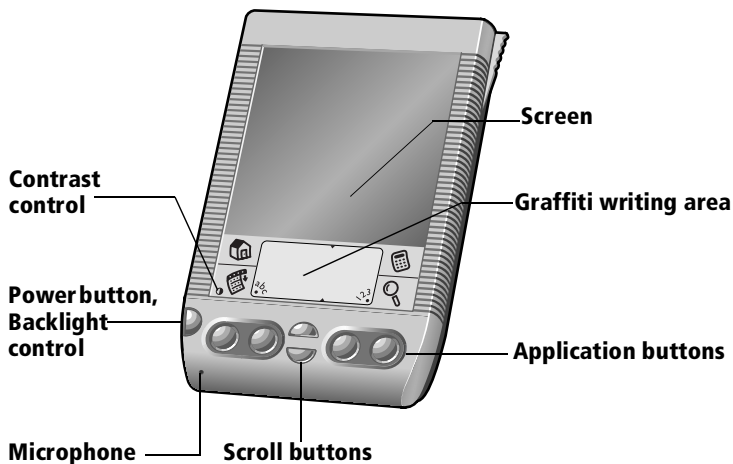

Visor handheld screen

Displays the applications and information stored in your Visor handheld. It is touch-sensitive and responds to the stylus.

Graffiti® writing area

The area where you write letters and numbers using the Graffiti® alphabet. See Chapter 2 to learn how to write Graffiti characters.

Application buttons

Activates the individual applications that correspond to the icons on the buttons: Date Book Plus, Address, To Do List, and Memo Pad. See “Buttons preferences” in Chapter 9 for details on reassigning these buttons to activate any application on your Visor handheld.

Tip: If your Visor handheld is turned off, pressing any application button activates the handheld and opens the corresponding application.

Scroll buttons

Displays text and other information that extends beyond the area of the Visor handheld screen. Pressing the bottom scroll button scrolls down to view information below the viewing area, and pressing the top scroll button scrolls up to view the information above the viewing area.

Contrast Control

Displays the contrast control screen where you can adjust the appearance of the screen for the clearest screen display. Depending on the lighting conditions or temperature of the environment where you use your handheld, you may need to adjust the contrast.

To adjust the contrast, drag the slider or tap the arrows to increase or decrease the contrast. To fine tune the contrast, press the scroll buttons on the front panel of your handheld.

Power button/backlight control

Turns your Visor handheld on or off and controls the backlight feature. If your Visor handheld is turned off, pressing the power button turns the unit on and returns you to the last screen you viewed.

If your Visor handheld is turned on, pressing the power button turns the unit off. Holding the power button down for about two seconds turns the backlight on or off.

Microphone Records sounds for use with Springboard expansion modules that support this feature.

Using the backlight

If you have difficulty seeing the information on your Visor handheld, you can use the backlight to illuminate your screen.

To activate the backlight:

- Press the power button and hold it down for about two seconds. Release the button when the backlight turns on.

Tip: In addition, you can assign the full-screen pen stroke to activate the backlight. See “Pen preferences” in Chapter 9 for more information.

To turn off the backlight:

- Press and hold the power button for about two seconds. The backlight also turns off automatically (after a period of inactivity) with the Auto-off feature. See “General preferences” in Chapter 9 for more information.

Protective cover

The cover protects the Visor handheld screen when it is not in use.

To remove the cover:

1. Unclip the top of the cover from your handheld.
2. Lift the cover off your handheld.

To reattach the cover:

1. Insert the pegs on the bottom of the cover into the holes on the bottom of your handheld.
2. Gently press the top of the cover onto your handheld until it clicks into place.

**Unclip top edge to
remove cover**

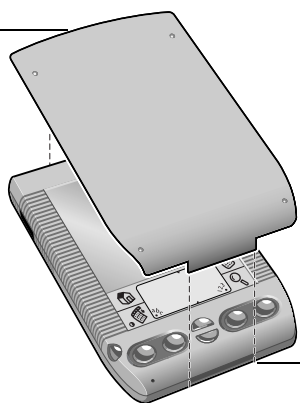

**Align pegs to
replace cover**

Locating back panel components

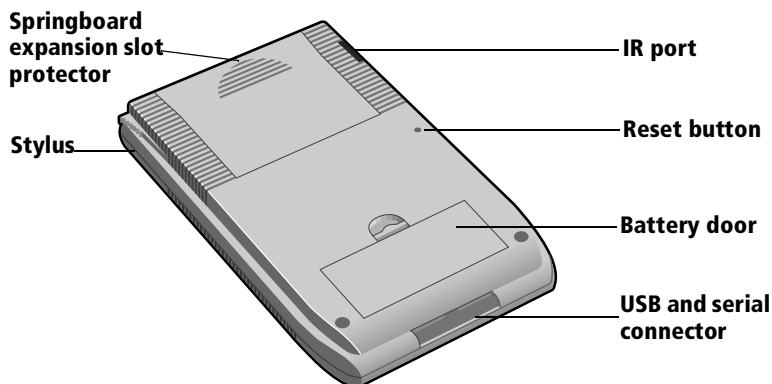

Springboard expansion slot protector

Slides in and out of the Springboard expansion slot. You can replace the slot protector with a Springboard expansion module to add features to your handheld.

Stylus

Slides in and out of the slot in the back panel of the handheld. To use the stylus, remove it from the slot and hold it as you would a pen or pencil.

IR port

Uses infrared technology to transmit data to and receive data from other Palm OS® handhelds. See “Beaming information” in Chapter 7 for more information. You can also use the IR port to update the information between your handheld and computer using HotSync technology. See “IR HotSync operations” in Chapter 8 for details.

Reset button

Under normal use, you should not have to use the reset button. See Appendix A for information about when and how to use the reset button.

Battery door

Covers the batteries that power your handheld.

USB and serial connector

The connector that connects your handheld to the cradle, which in turn connects to a USB port or serial port on your computer. This allows you to update the information between your handheld and computer using HotSync technology.

Installing the batteries

To use your Visor handheld, you must install two AAA alkaline batteries. The batteries fit behind the battery door on the back of the handheld. See "Battery considerations" in Appendix A for more information.

To install the batteries:

1. Press the latch on the battery door and lift the battery door away from your handheld.

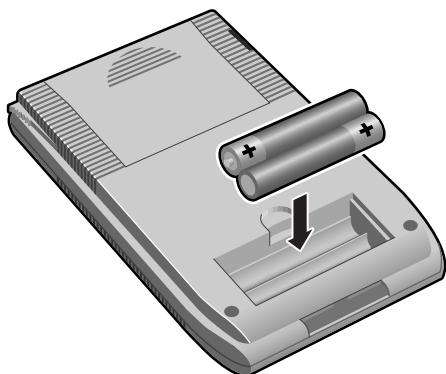

2. Install the two AAA alkaline batteries supplied with your handheld into the battery compartment.

Note: A diagram in the interior of the battery compartment shows + and - ends of the batteries. When correctly installed, the clips in the battery compartment secure the batteries in place.

3. Insert the battery door back into place so that it is flush with the back of your handheld and "clicks" into position.

Important: Do not force the battery door. When the batteries are correctly installed, the battery door clips smoothly into place. If you feel resistance when replacing the door, make sure the door is aligned with the slots on the back of your handheld, and that the batteries are firmly seated in the battery compartment.

Tapping and typing

Tap with the stylus to get things done

Like using a mouse to click elements on a computer screen, using the stylus to tap elements on your handheld screen is the basic action that gets things done on your handheld.

The first time you start your Visor handheld, setup instructions appear on the screen. These instructions include a calibration screen, or digitizer. Calibration aligns the internal circuitry of your handheld with its touch-sensitive screen so that when you tap an element on the screen, the handheld can detect exactly which task you want to perform.

Important: Always use the point of the stylus for tapping or making strokes on the handheld screen. Never use an actual pen, pencil, or other sharp object to write on the handheld screen.

With your handheld turned on, you can tap the handheld screen to perform many operations, such as the following:

- Open applications
- Choose menu commands
- Initiate a global Find operation
- Select options in dialog boxes
- Open the onscreen keyboards



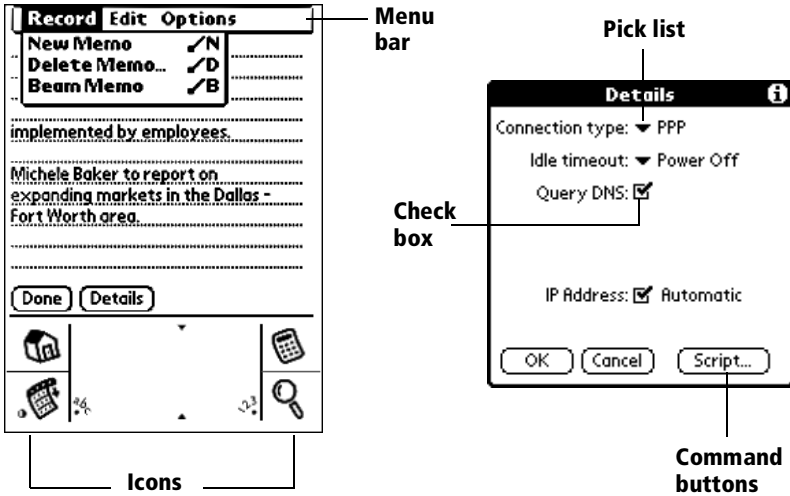

Just as you can drag the mouse to select text or move objects on your computer, you can also drag the stylus to select text. You can also use the stylus to drag the slider of any scroll bar.

Elements of the handheld interface



Menu bar A set of commands that are specific to the application. Not all applications have a menu bar.

Command buttons Tap a button to perform a command. Command buttons appear in dialog boxes and at the bottom of application screens.

Icons Tap the icons to open applications , menus , Calculator , and to find text anywhere in your data .

abc With the cursor in an input field, tap the dot to activate the alphabetic keyboard.

123 With the cursor in an input field, tap the dot to activate the numeric keyboard.

Check box When a check mark appears in a check box, the corresponding option is active. If a check box is empty, tapping it inserts a check mark. If a check box is checked, tapping it removes the check mark.

Pick list Tap the arrow to display a list of choices, and then tap an item in the list to select it.



Previous/next arrows



Scroll bar

Next/ previous arrows

Tap the up and down arrows to display the previous and next page of information; tap the left and right arrows to display the previous and next record.

Scroll bar

Drag the slider, or tap the top or bottom arrow, to scroll the display one line at a time. To scroll to the previous page, tap the scroll bar just above the slider. To scroll to the next page, tap the scroll bar just below the slider.

You can also scroll to the previous and next pages by pressing the scroll buttons on the front panel of your handheld.

Opening applications

You can use the Applications Launcher to open any application installed on your handheld. You can also open the four main applications — Date Book Plus, Address, To Do List, and Memo Pad — with the application buttons on the front panel of your handheld.

Tip: When you press an application button on the front panel, you have instant access to the selected application. You don't even need to turn on your handheld first.

In addition to providing a way for you to open applications, the Applications Launcher displays the current time, battery level, and application category.

To open an application:

1. Tap the Applications icon .



2. Tap the icon of the application that you want to open. If you have many applications installed on your Visor handheld, tap the scroll bar to see all of your applications.

Tip: To find an application quickly, you can write the Graffiti character for the first letter of its name. The Applications Launcher scrolls to the first application with a name that begins with that letter. You can also assign application icons to different categories. See “Categorizing applications” in Chapter 3.

Using menus

Menus on your handheld are easy to use. Once you have mastered them in one application, you can use them the same way in all other applications.

The menus of each application are illustrated in the section on that application in Chapter 4. The Edit menu is described in “Editing records” in Chapter 4.

To open the menu bar:

1. Do one of the following:
 - Open an application (such as Memo Pad) and then tap the Menu icon .
 - Tap the inverted tab at the top of any application’s screen (except Calculator).

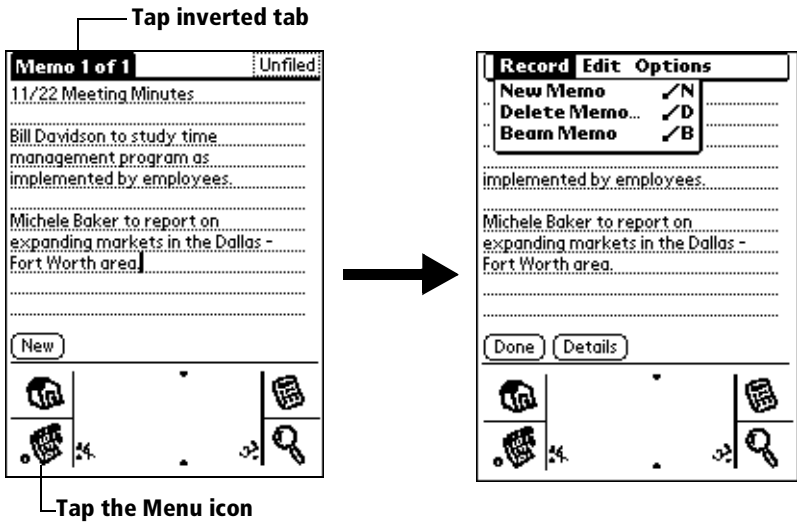

In this example, three menus are available: Record, Edit, and Options. The Record menu is selected and contains the commands New Memo, Delete Memo, and Beam Memo.

Choosing a menu

After you open the menu bar for an application, tap the menu that contains the command you want to use.

The menus and menu commands that are available depend on the application. Also, the menus and menu commands vary depending on *which part* of the application you're using. For example, in Memo Pad, the menus are different for the Memo list screen and the Memo screen.

Graffiti menu commands

Most menu commands have an equivalent Graffiti Command stroke, which is similar to the keyboard shortcuts used to execute commands on computers. The command letters appear to the right of the command names. To use the Graffiti menu commands, the menu bar must be closed.



To use the Graffiti menu commands:

1. In the Graffiti text area, draw a diagonal line from the lower left to upper right.

The Command toolbar appears for about four seconds.

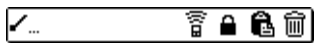

Command toolbar

2. Immediately write the corresponding command letter in the Graffiti letter area.

For example, to choose Select All in the Edit menu, draw the Command stroke, followed by the letter "s."

Tip: If you wait more than three seconds to write the menu command, you need to redraw the Graffiti Command stroke to redisplay the Command toolbar.

Command toolbar

The Command toolbar provides quick access to frequently used menu commands. The commands available vary based on the active screen.

To use the command toolbar:

1. In the Graffiti text area, draw a diagonal line from the lower left to upper right.

The Command toolbar appears for about four seconds.

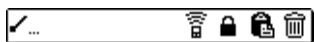

Command toolbar

2. Tap the icon for the command you want.

Tip: If you wait more than three seconds to tap the icon, you need to redraw the Graffiti Command stroke to redisplay the Command toolbar.

Displaying online tips

Many of the dialog boxes that appear on your handheld contain an online Tips icon in the upper-right corner. Online tips anticipate questions you have in a dialog box, provide shortcuts for using the dialog box, or give you other useful information.

To display an online tip:

1. Tap the Tips icon (i).
2. After you review the tip, tap Done.

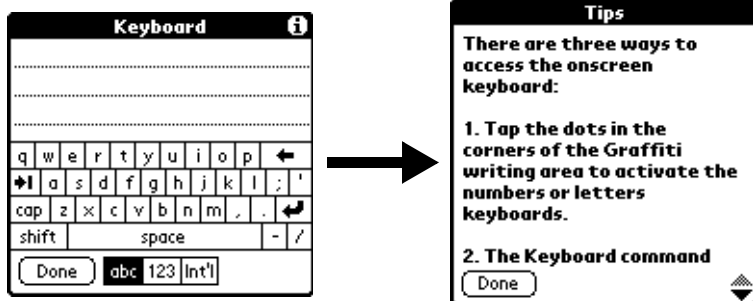

Four ways to enter data

There are four ways to enter data into your Visor handheld:

- Using Graffiti writing
- Using the onscreen keyboard
- Entering or importing data in Palm Desktop software and then synchronizing with your handheld
- Using an external keyboard

Graffiti writing

Your Visor handheld includes Graffiti writing software as the primary system for entering text and numbers. With Graffiti writing, you write simple strokes with the stylus and they are instantly recognized as letters or numbers.

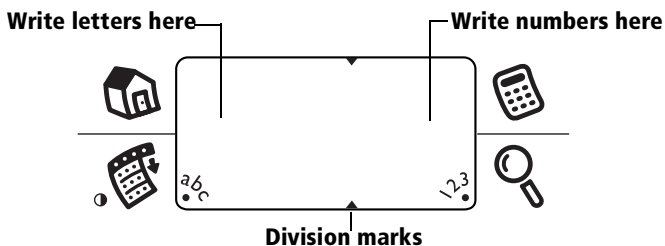

Your Visor handheld also includes Giraffe, a game you can use to practice Graffiti writing. See "Installing and removing applications" in Chapter 3 for installation instructions. The Memo Pad application is ideal for practicing Graffiti writing. This section explains how to open Memo Pad and use it to practice Graffiti writing.

To open Memo Pad:

1. Press the Memo Pad application button .
2. Tap New.

Note: A blinking cursor appears on the first line of the new memo to indicate where new text will appear.

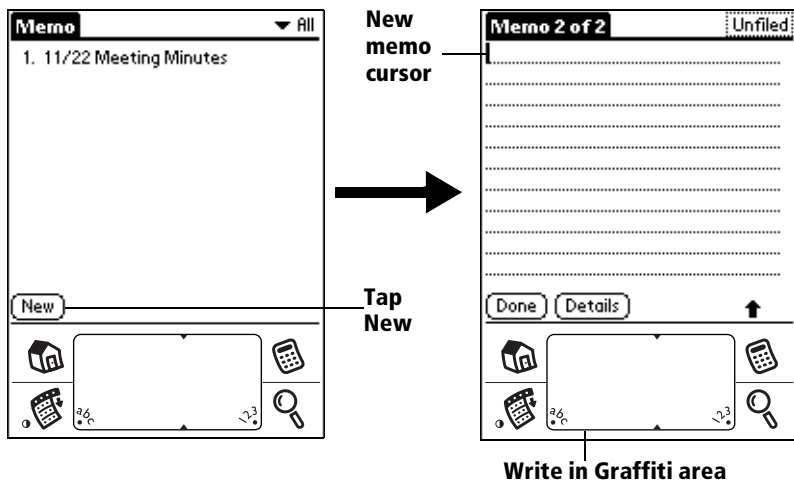

See “Using Graffiti writing to enter data” in Chapter 2 for more information.

Onscreen keyboard

When you create or edit a record in an application such as Address, you can open the onscreen alphabetic and numeric keyboards to enter data.

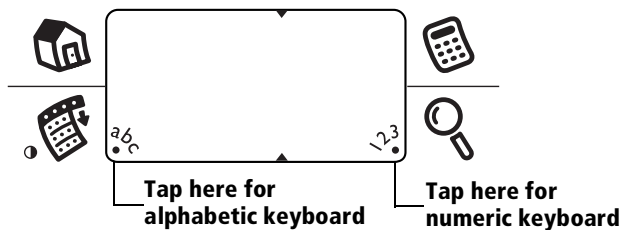

After a keyboard is open, you can tap to open any of the other keyboards, including the international keyboard. See “Using the onscreen keyboard” in Chapter 2 for more information.

Note: You cannot enter Graffiti characters while using the onscreen keyboard.

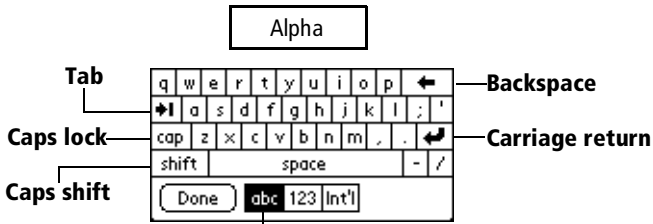

Tap here to display alphabetic keyboard

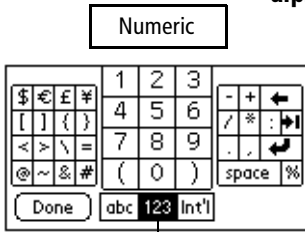

Tap here to display numeric keyboard

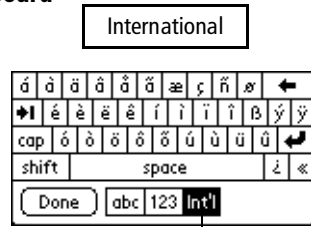

Tap here to display international keyboard

Using Palm Desktop software

If you have new records you want to add to your Visor handheld and prefer to use the computer keyboard rather than the onscreen keyboard, enter the data in Palm Desktop software or the PIM you have installed to use with your handheld.

After the information is in Palm Desktop software, perform a HotSync operation to synchronize your handheld with your computer. See “Exchanging and updating data: HotSync operations” in Chapter 5 for more information.

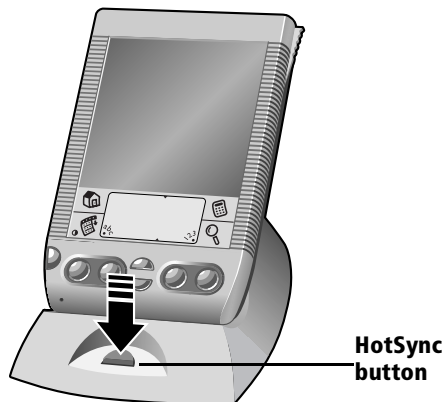

Importing data

If you already have data in a database on your computer, you can import it into Palm Desktop software. You can import data stored in computer applications such as spreadsheets and databases, or data from another Palm OS handheld. When you import data, you transfer the records to your Visor handheld without having to enter them manually. See "Importing data" in Chapter 2 for more information.



Using an external keyboard

You can connect an optional keyboard accessory to the connector on your handheld so you can type data directly into your handheld. External keyboards are very helpful when you need to enter large amounts of data quickly and accurately while you are away from your computer. For more information about external keyboard accessories, go to the web site: www.handspring.com.

Customizing your handheld

You can customize your handheld by using the Preferences application. You can enter personal information such as your name and address; change the time and date; view different date and time formats when you travel; turn off sounds; and configure your handheld to work with a modem or network. See Chapter 9 for more information on customizing your handheld.

To open the Preferences screens:

1. Tap the Applications icon .
2. Tap the Preferences icon .
3. Tap the category pick list in the upper-right corner of the screen.
4. Tap the Preferences category you want to view.

The following procedures for setting the time and date give you an example of how to customize your handheld. You make changes to the time and date in General preferences.

To set the current time:

1. Tap the Set Time box.

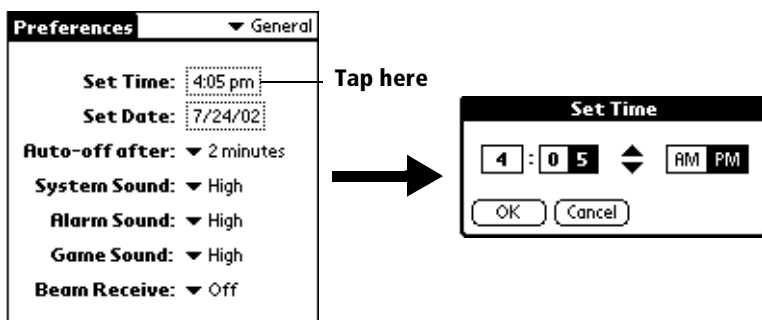

2. Tap the up or down arrows to change the hour.
3. Tap each minute number, and then tap the arrows to change them.
4. Tap AM or PM.

Note: Your handheld can also display time based on a 24-hour clock. See "Formats preferences" in Chapter 9 for more information.

5. Tap OK.

To set the current date:

1. Tap the Set Date box.
2. Tap the arrows to select the current year.

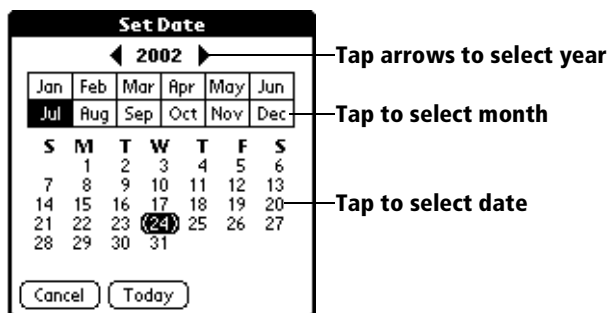

3. Tap a month.
4. Tap the current date.

Palm Desktop software

Palm Desktop software includes the same main applications as your Visor handheld: Daily Calendar (Date Book), Contact List (Address), Task (To Do List), and Note (Memo Pad). You can use the HotSync feature of this software to back up and exchange data between your handheld and your computer.

It is a good idea to back up your data in case something happens to the data on your Visor handheld. Changes you make on your Visor handheld or Palm Desktop software appear in both places after you synchronize.

With Palm Desktop software, you can do the following:

- Work with your Visor handheld applications on your computer. Palm Desktop software duplicates the Daily Calendar (Date Book), Contact List (Address), Task (To Do List), and Note (Memo Pad) applications on your handheld, so you can view, enter, and modify any data stored on your handheld.
- Back up the data stored on your handheld with HotSync technology and synchronize the data on your Palm Desktop software. Synchronization is a one-step procedure that ensures your data is always safe and up-to-date. See “Exchanging and updating data: HotSync operations” in Chapter 5 for more information.
- Import and export data, so you can easily transfer data from other desktop applications into any of your main applications. See “Importing data” in Chapter 2 for more information.
- Print your Palm Desktop information on any printer.

Connecting the cradle

The cradle that comes with your Visor handheld enables you to synchronize the information on your Visor handheld with your Palm Desktop software using HotSync technology.

Note: If your computer does not have a USB port, or it uses MacOS 8.0 or earlier, you need a serial cradle to connect to your computer. You can purchase a serial cradle from www.handspring.com.

To connect the cradle:

1. Plug the cable from the Visor handheld cradle into the USB port or serial port on your computer.

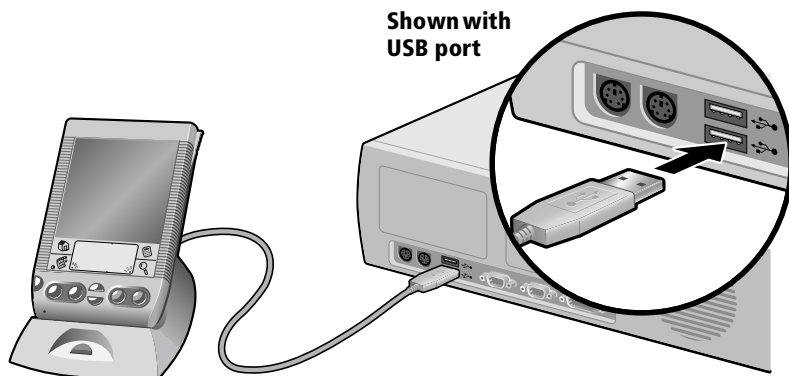

Note: If you are unsure about the exact location of the USB port or serial port on your computer, refer to the manual supplied with the computer.

Installing Palm Desktop software

The following instructions guide you through installing Palm Desktop software. After installation, refer to the online Help in Palm Desktop software for information about how to use the software.

Note: You must install the software that comes with your Visor handheld even if you already installed Palm Desktop software for a previous Palm organizer.

To ensure a safe and uninterrupted installation of Palm Desktop software, please do *not* simply copy the Palm Desktop software files to your computer's hard disk. You must use the installer to place the files in their proper locations and to decompress the files.

To install Palm Desktop software:

1. Exit any open programs, including those that run at startup, and disable any virus-scanning software.
2. Insert the Palm Desktop software CD-ROM into the computer's CD-ROM drive.
3. Double-click the Palm Desktop CD icon on the desktop.
4. Double-click the Installer icon to begin the installation process.
5. Follow the onscreen instructions to complete the installation.

Using your handheld with another PIM

If you prefer to use another personal information manager (PIM), you can use it if third-party connection software, called a conduit, is available for your PIM. You must install the software that came with your Visor handheld along with the conduit for your PIM to synchronize the data between your handheld and your PIM. For information on conduit software, go to this web site: www.handspring.com.

Installing a Springboard module

Springboard expansion modules enable you to extend the functions of your handheld. To install a Springboard module, simply remove the slot protector and insert the module in the Springboard expansion slot until the connectors are secure.

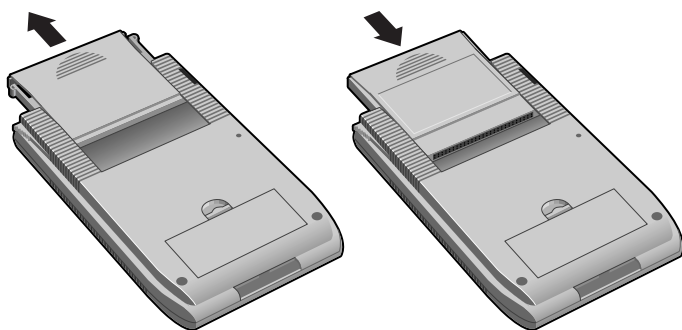

Chapter 2

Entering Data in Your Visor Handheld

This chapter explains how to enter data into your Visor handheld computer, by writing with the stylus in the Graffiti® writing area, by using the onscreen keyboard, by using the computer keyboard, by using an external keyboard, or by importing data from another application.

Using Graffiti writing to enter data

Chapter 1 introduced Graffiti writing and briefly described how to use it to enter text in your applications. In this section, you learn the procedures for creating letters, numbers, punctuation, and symbols as well as some Graffiti tips and tricks.

Writing Graffiti characters

Most people find they can enter text quickly and accurately with only minutes of practice. Graffiti writing includes any character you can type on a standard keyboard. The Graffiti strokes closely resemble the uppercase letters of the regular alphabet, which makes Graffiti writing easy to learn.

There are four basic concepts for success with Graffiti writing:

- If you draw the character shape exactly as shown in the tables later in this chapter (like the shapes shown in the following diagram), you achieve 100% accuracy.



- The heavy dot on each shape shows where to begin the stroke. Certain characters have similar shapes, but different beginning and end points. Always begin the stroke at the heavy dot (you should not create the heavy dot; it is only there to show you where to begin the stroke).

- Most characters require only a single stroke. When you lift the stylus from the Graffiti writing area, your handheld recognizes and displays the text character immediately. To accomplish single strokes, some Graffiti strokes are portions of the regular alphabet equivalents.
- The Graffiti writing area is divided into two parts: one for writing the letters of the alphabet and one for writing numbers. The small marks at the top and bottom of the Graffiti writing area indicate the two areas.

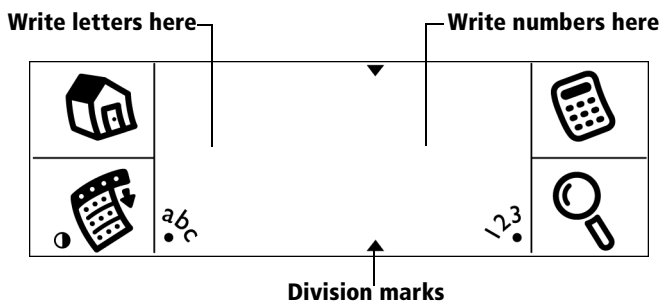

To write Graffiti letters:

1. Tap the screen where you want your text to go.

Note: You need to tap above the Graffiti writing area, and must see a blinking cursor before you write the text.

2. Use the tables on the following pages to find the stroke shape for the letter you want to create. For example, the stroke shown below creates the letter “n.”

Note: There are two different stroke shapes available for some letters. For these letters, choose the one that’s easiest for you.

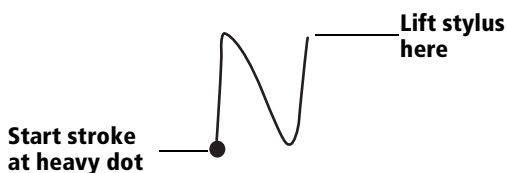

As you’ll see later, you use the same shape to create both the uppercase and lowercase version of a letter.

3. Position the stylus in the left-hand side of the Graffiti writing area.
4. Start your stroke at the heavy dot and draw the stroke shape as it appears in the tables.
5. Lift the stylus from the screen at the end of the stroke shape.

That's all there is to it! When you lift the stylus from the screen, your handheld recognizes your stroke immediately and prints the letter at the insertion point on the screen.

As soon as you lift the stylus from the screen, you can begin the stroke for the next character you want to write.



























Important: You must begin the character strokes in the Graffiti writing area. If you do not make Graffiti strokes in the Graffiti writing area, your handheld does not recognize them as text characters.

Graffiti tips

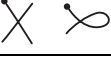
When using Graffiti writing, keep these tips in mind:

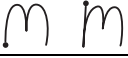
- Accuracy improves when you write large characters. You should draw strokes that nearly fill the Graffiti writing area.
- To delete characters, simply set the insertion point to the right of the character you want to delete and make the backspace stroke (a line from right to left) in the Graffiti writing area.
- Write at natural speed. Writing too slowly can generate recognition errors.
- Do not write on a slant. Vertical strokes should be parallel to the sides of the Graffiti writing area.
- Press firmly.

The Graffiti alphabet

Letter	Strokes	Letter	Strokes
A		N	
B		O	
C		P	
D		Q	
E		R	
F		S	
G		T	
H		U	
I		V	
J		W	
K		X	
L		Y	
M		Z	
Space		Back Space	
Carriage Return		Period	<i>tap twice</i>

Writing capital letters

You make capital letters with the same stroke shapes as the basic alphabet characters. To make capital letters, you must first “shift” to caps — just as you press the Shift key on a keyboard — and then write the character strokes.

Note: Graffiti writing includes a feature that automatically capitalizes the first letter when you create a new sentence or a new record (by tapping New or a blank line).

To draw the first letter of a word as a capital letter:

- Use the Caps Shift stroke:

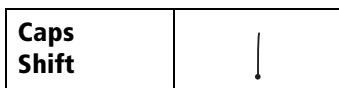

Tip: When Caps Shift is active, an “up arrow” symbol appears in the lower-right corner of the handheld screen. If you accidentally activate Caps Shift, backspace will cancel it.



To enter only capital letters (Caps Lock):

- Use the Caps Lock stroke:





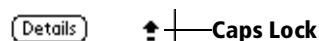







Tip: When Caps Lock is active, an underlined “up arrow” symbol appears in the lower-right corner of the handheld screen. To return to lowercase, make the Caps Shift stroke.



Writing numbers

Writing numbers with Graffiti writing is similar to writing letters of the alphabet, except that you make the character strokes on the right-hand side (numbers side) of the Graffiti writing area.

Graffiti numbers

Number	Strokes	Number	Strokes
0		5	
1		6	
2		7	
3		8	
4		9	

Writing punctuation marks

Graffiti writing can create any punctuation symbol that you can enter from a standard keyboard. All punctuation marks begin with a single tap on the Graffiti writing area. When you make this tap, you activate Punctuation Shift and a dot appears to show it is active. The next stroke you make with the stylus creates a punctuation mark.

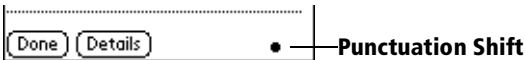

Note: When Punctuation Shift is active, you can make a symbol stroke anywhere in the Graffiti writing area (the letters *or* numbers side).

Symbol	Stroke	Symbol	Stroke
Period .	•	Dash —	—
Comma ,	,	Left Paren ((
Apostrophe '	'	Right Paren))
Question ?	?	Slash /	/
Exclamation !	!	Dollar \$	\$

Additional Graffiti punctuation

@	#	%	^	&	*	<	>	-	+	=	
@	#	%	^	&	*	<	>	-	+	=	
\	{	}	[]	~	`	:	:	"	tab	
\	{	}	[]	~	`	:	:	"	tab	

Writing symbols and extended characters

All symbols and extended characters begin with the stroke in the Graffiti writing area of your handheld:

Symbol Shift	
---------------------	--

When the Symbol Shift is active, a slanted shift symbol appears in the lower-right corner of the screen. The next stroke that you make creates the symbol or extended character.

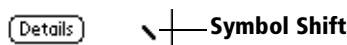

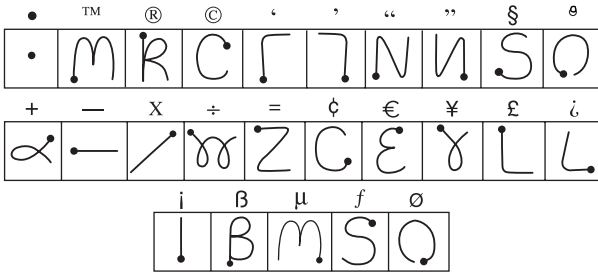

Writing accented characters

To create accented characters, draw the stroke normally used to create the letter, followed by an accent stroke. Graffiti writing then adds the accent to the letter.

For example, the following diagram shows the strokes required to draw an accented “e.”

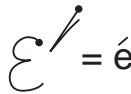

Accent strokes

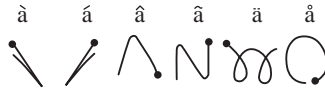

Using these accent strokes, you can write the following accented letters:

à á â ã ä å è é ì í î ò ó ô õ ù ú û ü ý ÿ ñ

Additional non-English characters



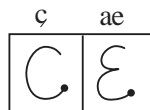

You can write the following characters in the lowercase alphabet mode without any special punctuation or shifting:



Note: You must write these non-English characters in the left side of the Graffiti writing area.

Navigation strokes

In addition to character symbols, Graffiti writing includes special strokes that you can use to navigate within text or fields in your applications.

Command	Stroke
Move cursor right	
Move cursor left	
Previous field (Address only)	
Next Field (Address only)	
Open Address Record (Address only)	

Graffiti ShortCuts

Graffiti ShortCuts make entering commonly used words or phrases quick and easy. ShortCuts are similar to the Glossary or Autotext features of some word processors.

Graffiti writing comes with several predefined ShortCuts, and you can also create your own. Each ShortCut can represent up to 45 characters. For example, you might create a ShortCut for your name, or for the header of a memo. See “ShortCuts preferences” in Chapter 9 to learn about creating your own ShortCuts.

To use a ShortCut, draw the ShortCut stroke followed by the ShortCut characters. When you draw the ShortCut stroke, the ShortCut symbol appears at the insertion point to show that you are in ShortCut mode.

ShortCut	
----------	---

Your handheld includes the following predefined Graffiti ShortCuts:

Entry	ShortCut
Date stamp	ds
Time stamp	ts
Date / time stamp	dts
Meeting	me
Breakfast	br
Lunch	lu
Dinner	di

Using the onscreen keyboard

You can open the onscreen keyboard anytime you need to enter text or numbers on your handheld. Note that you cannot enter Graffiti characters while using the onscreen keyboard.

To use the onscreen keyboard:

1. Open any application (such as Memo Pad).
2. Tap any record, or tap New.
3. Tap "abc" to open the alphabetic keyboard, or tap "123" to open the numeric keyboard.

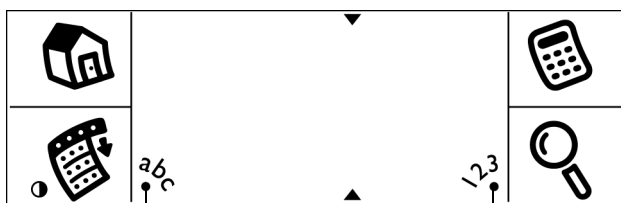

Tap here for alpha keyboard

Tap here for numeric keyboard

4. Tap the characters to enter text and numbers.

Note: The onscreen keyboard also includes a dialog box for international characters. You can switch among the three dialogs at any time to enter the exact text you need.

5. After you finish, tap Done to close the onscreen keyboard and place the text in the record.

Using your computer keyboard

If you have a lot of data to enter, or prefer to use the computer keyboard, you can use Palm™ Desktop software, or any supported PIM, to enter information. You can then perform a HotSync® operation to synchronize the information on your computer with the information on your handheld. All the main applications on your handheld are available in Palm Desktop software and in most PIMs. Refer to Palm Desktop online Help for more information on entering data on your computer.

Importing data

If you have data stored in computer applications such as spreadsheets and databases, you can transfer the data to your Visor handheld without having to key it in manually. Save the data in one of the file formats listed below, import it into Palm Desktop software, and then perform a HotSync operation to transfer the data to your handheld.

You can import data from any of the following PIM (personal information manager) products.

- Address Book Plus
- DateBook Pro
- DayMaker
- Dynodex
- Meeting Maker
- Now Contact
- Now Up-to-Date
- QuickDex
- TouchBase Pro

Palm Desktop software can open Claris Organizer files directly; you do not need to import them. To import data from PIM product files, you must export and save the entire file in text format first. You can import fields from TouchBase Pro, DateBook Pro, DayMaker, and QuickDex files in the proper order. You might have to adjust the field order of other PIM product files you import.

You can also import data from a FileMaker Pro database or a ClarisWorks database. In FileMaker Pro, be sure to export the database to the Tab-Separated Text file type. In ClarisWorks, be sure to save the database in ASCII text format and give it a different name so you don't overwrite the original file.

You can import data from a Newton that uses Newton Operating System 1.0. Simply use the Newton Connection Kit to export data from the Newton Names file, Date Book Calendar file, and Notepad, and then import the resulting files into Palm™ Desktop software. The Newton Connection Kit does not work with Newton Operating System 2.0.

To import data:

1. Export a text file from the other product.
2. Open Palm Desktop software.
3. From the File menu, choose Import.
4. Select the file you want to import.
5. Click Open.
6. In the Import dialog box, check each field name to be sure the correct data moves into the correct fields.

To change the order of a field in the file you're importing into, move the pointer over a field name in the Fields In list. When the pointer changes to double arrow, drag the name to a new location.

To prevent information from importing into a field, click the arrow between field names. The arrow changes to a dotted line.

To view the information in the file you're importing from, click the Scan Data arrows to see the information in each record.

7. From the Fields pop-up menu, choose the appropriate field.
8. From the Delimiters pop-up menu, choose the appropriate delimiter.

The field and delimiter are set automatically if you are importing a Claris Organizer, TouchBase Pro, DateBook Pro, DayMaker, or QuickDex file.

9. Click OK.

Using an external keyboard

You can connect an optional keyboard accessory to the connector on your handheld so you can type data directly into your handheld. External keyboards are very helpful when you need to enter large amounts of data quickly and accurately while you are away from your computer.

Chapter 3

Managing Your Applications

This chapter explains how to switch between applications on your Visor handheld computer, how to change application settings so they are personalized to your work methods, and how to categorize applications so you view them in related groups.

Using the Applications Launcher

To open the Applications Launcher, tap the Applications icon .

Selecting applications

Your Visor handheld is equipped with a variety of applications. All the applications installed on your handheld appear in the Applications Launcher. See “Opening applications” in Chapter 1 for details.



Switching between applications

When working in any application, tap the Applications icon  or press an application button on the front panel of your handheld to switch to another application. Your handheld automatically saves your work in the current application and displays it when you return to that application.

Categorizing applications

The category feature enables you to manage the number of application icons that appear onscreen in the Applications Launcher. You can assign an application to a category and then display a single category or all your applications.

To categorize an application:

1. Tap the Applications icon .
2. Tap the Menu icon .
3. Tap App, and then tap Category.
4. Tap the pick list next to each application to select a category.



Tip: To create a new category, tap Edit Categories from the pick list. Tap New, enter the category name, and then tap OK to add the category. Tap OK.

5. Tap Done.

To display applications by category:

1. Tap the Applications icon .
2. Do one of the following:



Tap the Applications icon repeatedly to cycle through all your categories.

Tap the pick list in the upper-right corner of the screen and select the category you want to display.

Changing the Applications Launcher display



By default, the Applications Launcher displays each application as an icon. As an alternative, you can choose to show a list of applications. You can also choose to view the same category of applications each time you open the Applications Launcher.

To change the Applications Launcher display:

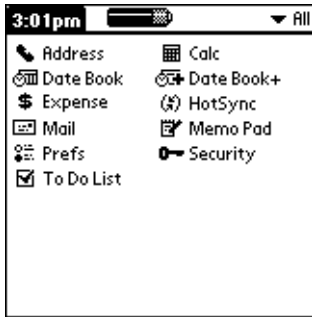
1. Tap the Applications icon .
2. Tap the Menu icon .
3. Tap Options, and then tap Preferences.
4. Tap the View By pick list and select List.
5. Tap OK.



To open the Applications Launcher to the last opened category:

1. Tap the Applications icon .
2. Tap the Menu icon .
3. Tap Options, and then tap Preferences.
4. Tap the Remember Last Category check box to select it.
5. Tap OK.

Choosing preferences

You can set options that affect an entire application in the application's Preferences dialog box.

To change preferences for an application:

1. Open an application.
2. Tap the Menu icon .
3. Tap Options, and then tap Preferences.

Note: Not all applications have a Preferences command.

4. Make changes to the settings.
5. Tap OK.

Installing and removing applications

This section explains how to install and remove applications on your Visor handheld and how to remove Palm™ Desktop software from your computer.

Installing add-on applications

Your Visor handheld comes with the Date Book, Date Book Plus, Address, To Do List, Memo Pad, Expense, Calculator, City Time, and Mail applications installed and ready to use.

You can also install additional applications on your handheld, such as games and other software. The Install Handheld Files dialog box makes it easy to install software on your Visor handheld during a HotSync® operation. There are a variety of third-party applications available for your Visor handheld. To learn more about these applications, go to the web site: www.handspring.com.

Note: Any game or application that you install on your handheld resides in RAM memory; you can delete them at any time.

To install add-on software on your handheld:

1. Copy or download the application you want to install into the add-on folder in your Palm folder on your computer.

Note: If the software you download is compressed, you need to decompress it into this folder. If you prefer to place the application into another folder, you need to navigate to that folder before you complete step 5.

2. Double-click the Palm Desktop icon on your desktop.
3. From the HotSync menu, choose Install Handheld Files.

Tip: You can also access the Install Handheld Files dialog box by double-clicking any file with a PRC file extension.

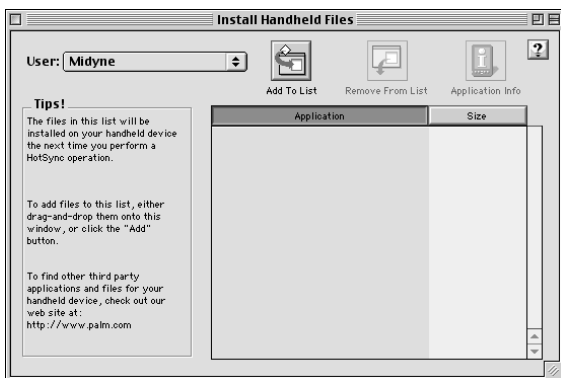

4. From the User pop-menu, select the name that corresponds to your Visor handheld.
5. Click Add to List.

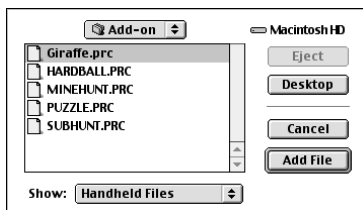

6. Select the application(s) you want to install on your handheld.
7. Click Add File.

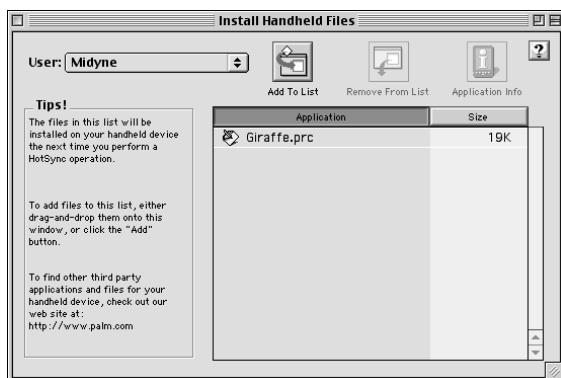

Note: Review the list of applications you selected in the Install Handheld Files dialog box. If you do not want to install an application, select it, and then click Remove From List. (This does not remove the application from your computer; it simply removes it from the list of applications to install.)

8. Close the Install Handheld Files dialog box.
9. Perform a HotSync operation to install the application(s) you selected in step 6. See “Exchanging and updating data: HotSync operations” in Chapter 5 for details.

Installing games

The CD-ROM also includes several games that you can install with the Install Tool:

- Giraffe
- HardBall
- MineHunt
- Puzzle
- SubHunt



Note: Giraffe is a fun, easy way for you to practice Graffiti® writing.

After you install and start a game, the instructions appear in the Game menu. Depending on the game, the Game menu may also contain commands to show high scores, to start a new game, or to set preferences for the game.

Removing applications

In the event that you run out of memory or decide that you no longer need an application you installed, you can remove applications from your handheld. You can remove only add-on applications, patches, and extensions that you install; you cannot remove the applications that reside in the ROM portion of your handheld.

To remove an add-on application:

1. Tap the Applications icon .
2. Tap the Menu icon .
3. Tap App, and then tap Delete.
4. Tap the application that you want to remove.



5. Tap Delete.
6. Tap Yes.
7. Tap Done.
8. Check the User folder in the Palm folder on your computer. If you find a PRC file for the application you just removed, delete the PRC file from the User folder.

Removing Palm Desktop software

If you no longer want to use Palm Desktop software, you can remove it from your computer.

To remove Palm Desktop software:

1. Insert the Palm Desktop software CD-ROM into your computer's CD-ROM drive.
2. Double-click the Palm Desktop CD icon on the desktop.
3. Double-click the Installer icon.
4. Click Continue on the splash screen and on the Palm Computing Readme file screen.
5. Click Agree on the End User Software License Agreement screen.
6. In the Palm Desktop Installer window, select Uninstall from the pop-up menu in the upper-left corner.

The Palm Desktop Installer shows the items you can uninstall.

7. Select all the items on the uninstall list by clicking the check box to the left of each selection.
8. Click Uninstall.
9. When prompted to select the files where your Palm files are installed, click the Palm folder.

Tip: If you installed the Palm Desktop software in a different folder, use the file selector to find the folder that contains these files.

10. Click Remove Palm and then click OK.

11. Restart your Macintosh.

Security

Your handheld comes with a Security application so that unauthorized users cannot view the entries you wish to protect.



In Security, you can do the following:

- Mask or hide entries you define as private. The Mask option displays a gray bar over private records, and the Hide option completely removes (hides) private records. See “Making records private” in Chapter 5 for more information.
- Assign a password to the Security viewing options. Assigning a password requires you to enter a password to view masked or hidden private entries; not assigning a password enables you (or anyone else) to view individual masked private entries by tapping them, and to view all hidden or masked private entries by selecting Show Records in the Security dialog box.
- Lock and turn off your handheld so that it does not operate until you enter the correct password.

Assigning a password

You can assign a password to protect your private records and to lock your handheld.

To assign a password:

1. Tap the Applications icon .
2. Tap the Security icon .
3. Tap the Password box.
4. Enter a password, and tap OK.

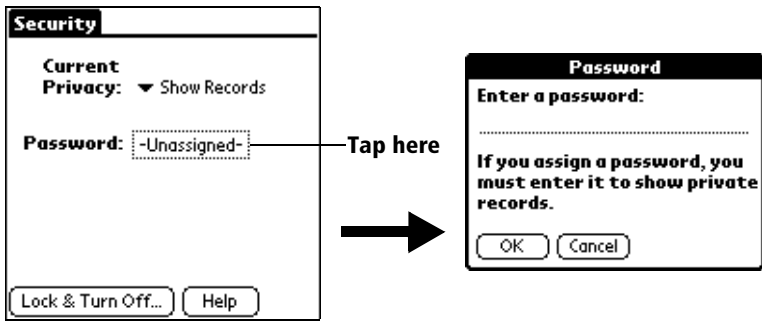

5. Enter the *same* password a second time, and tap OK.

Changing or deleting a password

Once you define a password for your handheld, you can change or delete it at any time. You must enter the current password before you can change or delete it.

To change or delete your password:

1. Tap the Password box.
2. Enter the current password.

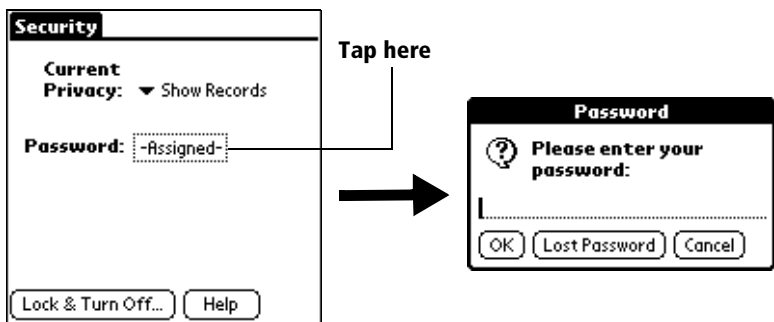

3. Tap OK.
4. Do one of the following:
 - To change the password, enter the new password, and tap OK.
 - To delete the password, tap Delete.



Locking your handheld

You can also lock your handheld so that you need to enter your password to operate it.

Important: If you lock your handheld, you must enter the exact password to re-activate your handheld. If you forget the password, you need to perform a hard reset to resume using your handheld. Performing a hard reset deletes all the records in your handheld; however, you can restore all previously synchronized data at the next HotSync operation. See “Performing a hard reset” in Appendix A for details.

To lock your handheld with a password:

1. Assign a password.
2. Tap Lock & Turn Off.

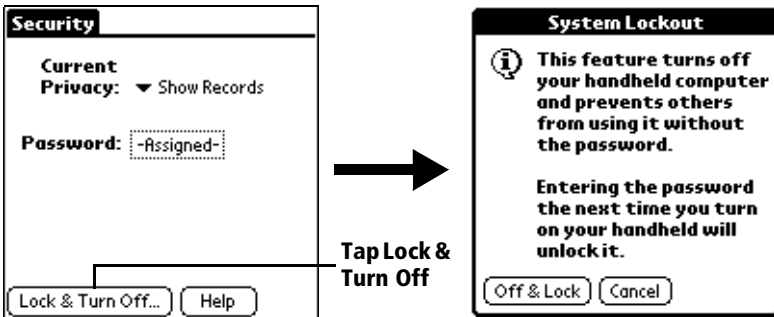

3. Tap Off & Lock.
4. To start your handheld, turn it on, and then enter the password.

Recovering from a forgotten password

If you did not activate the Off & Lock feature and you forget your password, you can delete the password from your handheld. Deleting a forgotten password also deletes all entries and files marked as Private.

Important: If you synchronize with your computer before deleting a forgotten password, your handheld restores your private entries the next time you perform a HotSync operation, but it does not restore the password.

To delete a forgotten password:

1. Tap the Password box.
2. Tap Lost Password.

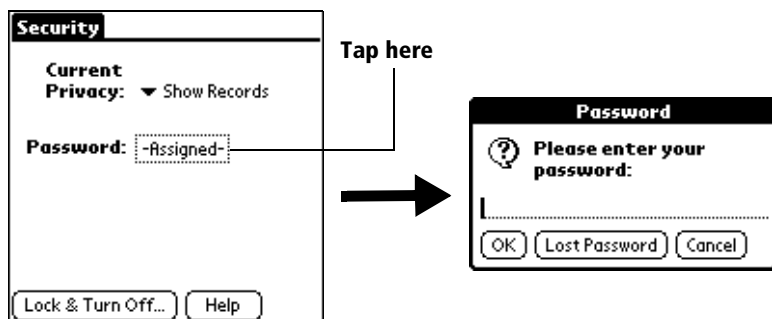

3. Tap Yes.

Chapter 4

Overview of Basic Applications

This chapter briefly describes each application and how to open it. Your Visor handheld computer includes these basic applications:

- Date Book
- Date Book Plus
- Address
- To Do List
- Memo Pad
- Calculator
- CityTime
- Expense

Date Book





Date Book lets you quickly and easily schedule appointments or any kind of activity associated with a time and date.

In Date Book, you can do the following:

- Enter a description of your appointment and assign it to a specific time and date.
- Display a chart of your appointments for an entire week. The Week View makes it easy to spot available times and any potential scheduling overlaps or conflicts.
- Display a monthly calendar to quickly spot days where you have morning, lunch, or afternoon appointments.
- Display an agenda with both your appointments and your To Do items.
- Set an alarm to sound prior to the scheduled activity.
- Create reminders for events that are based on a particular date, rather than time of day. Birthdays and anniversaries are easy to track with your handheld computer.
- Attach notes to individual events for a description or clarification of the entry in your Date Book.

To open Date Book:

1. Tap the Applications icon .
2. Tap the Date Book icon .



View icons

Note: Tap the view icons to select a Date Book view.

Date Book Plus



Date Book Plus is an enhanced version of the Date Book application. In addition to all the standard Date Book features, it provides a variety of advanced views and functions.

In Date Book Plus, you can do the following:

- View To Do items in select calendar views.
- Display a chart of your appointments for one or two weeks complete with descriptions of each event.
- Display a calendar of an entire year.
- Display a list of your appointments in List View.
- Create unscheduled events that float from one day to the next until you complete them.
- Create a Daily Journal to track events with automatic time stamps.
- Save event templates and use them to quickly create similar events.

To open Date Book Plus:

- Press the Date Book Plus application button on the front panel of your handheld. Date Book Plus opens to today's schedule.

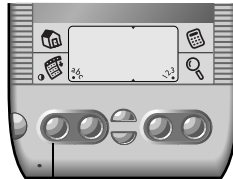

Date Book Plus button

Note: Press the Date Book Plus application button repeatedly to cycle through the Day, Week, Week with Text, Month, Year, and List views.

Address



Address enables you to keep names, addresses, phone numbers, and other information about your personal or business contacts.

In Address, you can do the following:

- Quickly look up, enter, or duplicate names, addresses, phone numbers, and other information.
- Enter up to five phone numbers (home, work, fax, mobile, etc.) or e-mail addresses for each name.
- Define which phone number appears in the Address list for each Address entry.
- Attach a note to each Address entry, in which you can enter additional information about the entry.
- Assign Address entries to categories so that you can organize and view them in logical groups.

To open Address:

- Press the Address application button on the front panel of your handheld. Address opens to display the list of all your records.

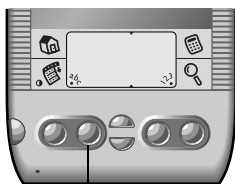

Address button

Note: Press the Address application button repeatedly to cycle through the categories in which you have records.

To Do List



To Do List is a convenient place to create reminders and prioritize the things that you have to do.

In To Do List, you can do the following:

- Make a quick and convenient list of things to do.
- Assign a priority level to each task.
- Assign a due date for any or all of your To Do items.
- Assign To Do items to categories so that you can organize and view them in logical groups.
- Sort your To Do items either by due date, priority level, or category.
- Attach notes to individual To Do items for a description or clarification of the task.

To open To Do List:

- Press the To Do List application button on the front panel of your handheld. To Do List opens to display the category of items you last viewed.

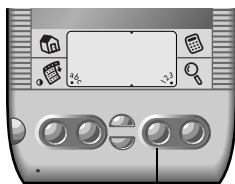

To Do List button

Note: Press the To Do List application button repeatedly to cycle through the categories in which you have items.

Memo Pad



Memo Pad provides a place to take notes that are not associated with records in Date Book, Address, or To Do List.

In Memo Pad, you can do the following:

- Take notes or write any kind of message on your handheld computer.
- Drag and drop memos into popular computer applications like Microsoft Word when you synchronize using Palm™ Desktop software and HotSync® technology.
- Assign memos to categories so that you can organize and view them in logical groups.
- Write down phone numbers and other types of information. Later, you can copy and paste this information to other applications.

To open Memo Pad:

- Press the Memo Pad application button on the front panel of your handheld. Memo Pad opens to display the last Memo Pad screen that you viewed.

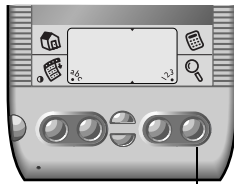

Memo Pad button

Note: Press the Memo Pad application button repeatedly to cycle through the categories in which you have memos.

Calculator



Calculator enables you to perform addition, subtraction, multiplication, division and a variety of advanced math and scientific calculations.

In Calculator, you can do the following:

- Select a view to perform specific types of calculations including: math, trigonometry, finance, logic, statistics, weight/temp, length, area, and volume.
- Store and retrieve values.
- Display the last series of calculations, which is useful for confirming a series of “chain” calculations.
- Create a custom view with the buttons you use most often.
- Switch to basic mode to perform simple calculations.

To open Calculator:

- Tap the Calculator icon  next to the Graffiti® writing area.

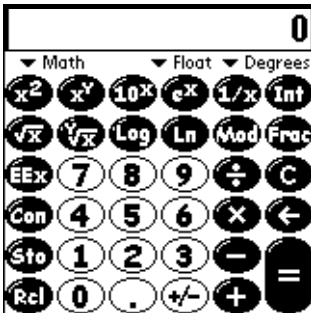

CityTime



CityTime helps you keep track of the time anywhere around the globe.

In CityTime, you can do the following:

- Select a home city as a point of reference.
- Display the day and time in four other cities simultaneously.
- Add a definition for any city that isn't in the default list.
- Display sunrise and sunset information for your home city.

To open CityTime:

1. Tap the Applications icon .
2. Tap the CityTime icon .

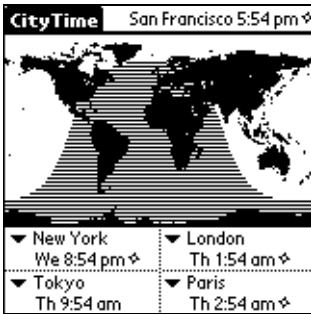

Expense



Expense lets you keep track of your expenses.

In Expense, you can do the following:

- Record dates, types of expenses, amount spent, payment method, and other details associated with any money that you spend.
- Assign expense items to categories so that you can organize and view them in logical groups.
- Keep track of vendors (companies) and people involved with each particular expense.
- Log miles traveled for a particular date or expense category.
- Sort your expenses by date or expense type.

To open Expense:

1. Tap the Applications icon
2. Tap the Expense icon

Expense		▼ All
4/14 Taxi	\$	20.00
4/14 Lunch	\$	42.75
4/14 Hotel	\$	98.25
4/14 Car Rental	\$	127.38

New Details... Show...

Note: You cannot use the Macintosh version of Palm Desktop software to synchronize Expense data between your handheld and your computer.

Chapter 5

Common Tasks

This chapter provides instructions on how to do tasks that you can do in most or all of the basic applications. It's easy to transfer what you learn in one application to the others because the structure and behavior of all the applications are quite similar. The term "records" is used to refer to an individual item in any of the basic applications: a single Date Book Plus event, Address entry, To Do List item, Memo Pad memo, or Expense item.

Creating records

You can use the following procedure to create a new record in Date Book, Date Book Plus, Address, To Do List, Memo Pad, and Expense.

To create a record:

1. Select the application in which you want to create a record.
2. Tap New.
3. In Date Book Plus only: Select a record type from the pop-up list, select the start and end times, and then tap OK.
4. Enter text for the record.
5. (Optional) Tap Details to select attributes for the record.
6. In Address and Memo Pad only: Tap Done.

There's no need to save the record because your handheld saves it automatically.

Editing records

After you create a record, you can change, delete, or enter new text at any time. Two screen features tell you when your handheld is in editing mode:

- A blinking cursor
- One or more edit lines

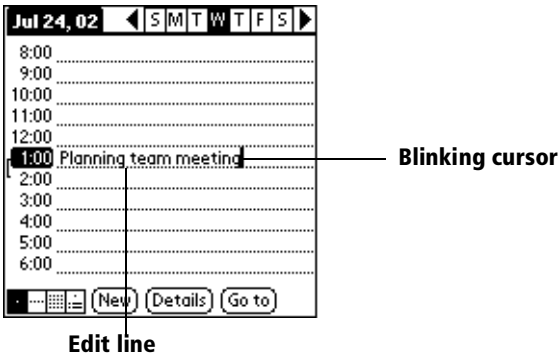

Entering text

For information on how to enter text using Graffiti writing, the onscreen keyboard, or the keyboard attached to your computer, see Chapter 2.

Edit menu

The Edit menu is available with any screen where you enter or edit text. In general, commands available in the Edit menu apply to text that you *select* in an application.

To select text in an application:

1. Tap the beginning of the text that you want to select.
2. Drag the stylus over the text to highlight it. You can drag *across* the text to select additional words, or drag *down* to select a group of lines.

Tip: To select a word, double-tap the word. To select a whole line, triple-tap the line.

The following commands may appear in an Edit menu:

- Undo** Reverses the action of the *last edit* command. For example, if you used Cut to remove text, Undo restores the text you removed. Undo also reverses deletions done by using backspace.
- Cut** Removes the selected text and stores it temporarily in the memory of your handheld. You can paste the text you cut into another area of the current application or into a different application.
- Copy** Copies the selected text and stores it temporarily in the memory of your handheld. You can paste the text that you copy into another area of the current application or into a different application.
- Paste** Inserts the text that you cut or copied at the selected point in a record. The text you paste replaces any selected text. If you did not previously cut or copy text, Paste does nothing.
- Select All** Selects all of the text in the current record or screen. This enables you to cut or copy all of the text and paste it elsewhere.
- Keyboard** Opens the onscreen keyboard. When you finish with the onscreen keyboard, tap Done.
- Graffiti Help** Opens screens that show all the Graffiti character strokes. Use this command anytime you forget a stroke for a character.

Deleting records

To delete a record in any of the basic applications:

1. Select the record you want to delete.
2. Tap the Menu icon .
3. Tap Record, and then tap the Delete command:

Date Book, Date Book Plus: Delete Event

Address: Delete Address

To Do List: Delete Item

Memo Pad: Delete Memo

Expense: Delete Item

A confirmation dialog box appears. If you want to save a copy of the deleted item to an archive file in Palm Desktop software, be sure that the check box is checked. If you don't want to save a copy, tap the check box to remove the check.

4. Tap OK.

If you choose to save a copy of the selected item, your handheld transfers it to the archive file on your desktop the next time you perform a HotSync operation.

Other ways to delete records

You can also delete records in the following ways:

- In the Details dialog box of the application, tap Delete, and then tap OK.
- Delete the text of the record.
- Tap the Delete icon  on the Command toolbar.

Note: In Date Book and Date Book Plus, if you delete the text of a repeating event, you delete all instances of that event.

Purging records

Over time, as you use Date Book or Date Book Plus, To Do List, and Expense, you'll accumulate records in these applications that have outlived their usefulness. For example, events that occurred months ago remain in the Date Book Plus, and To Do items that you marked as completed remain in the list, as do Expense items.

All these outdated records take up memory on your handheld, so it's a good idea to remove them by using Purge. If you think Date Book Plus or To Do List records might prove useful later, you can purge them from your handheld and save them in an archive file.

Purging is also available in Mail. See Chapter 7 for more information.

Purging is not available in Address or Memo Pad, so delete outdated records from these applications.

To purge records:

1. Open the application.
2. Tap the Menu icon .
3. Tap Record, and then tap Purge.

A confirmation dialog box appears.

Date Book, Date Book Plus: Tap the pick list and select how old a record must be to be purged. Purge deletes repeating events if the last of the series ends before the date that you purge records.

Date Book, Date Book Plus, To Do List: If you want to save a copy of the purged records to an archive file on your desktop, be sure that the check box is checked. If you don't want to save a copy, tap the check box to remove the check box.

4. Tap OK.

If you chose to save a copy of the purged records, your handheld transfers them to an archive file on your desktop the next time you perform a HotSync operation.

Note: Purging does not happen automatically. You must tap the command to make it happen.

Exchanging and updating data: HotSync operations

The HotSync process automatically synchronizes — that is, exchanges and updates — data between your handheld and Palm Desktop software. Changes you make on your handheld or Palm Desktop software appear in both places after a HotSync operation. HotSync technology synchronizes only the needed portions of files, thus reducing synchronization time. You can synchronize your data directly by connecting your handheld to your computer with the cradle or by beaming the data from the IR port on your handheld to the IR port on your computer, or indirectly with a modem or network. See Chapter 8 for information about performing HotSync operations via the IR port, a modem, or a network.

Performing a HotSync operation for the first time

The first time you synchronize your data, you need to enter user information on both the handheld and Palm Desktop software. After you enter this information and synchronize, the HotSync Manager recognizes your handheld and doesn't ask for this information again.

If you are a System Administrator preparing several handhelds for a group of users, you may want to create a user profile. See “Creating a user profile” in Chapter 8 before performing the following steps.

Important: You must use the cradle for your *first* HotSync operation.

The following steps assume that you have already installed the Palm Desktop software. If you have not installed this software, see “Installing Palm Desktop software” in Chapter 1 for instructions.

To perform a local HotSync operation:

1. Insert your handheld into the cradle.

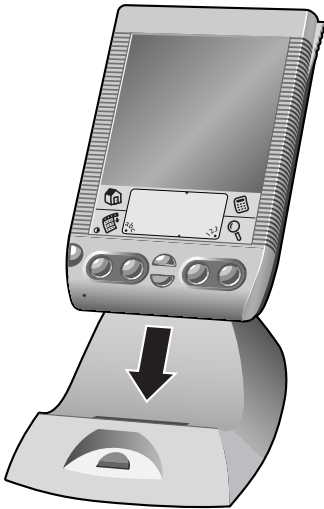

The bottom edge of the handheld should align smoothly with the cradle when it is inserted properly.

2. If the HotSync Manager is not enabled, activate it: Open Palm Desktop software, from the HotSync Menu, choose Setup. Click the HotSync Controls tab and select the Enabled option.
3. Press the HotSync button on the cradle.

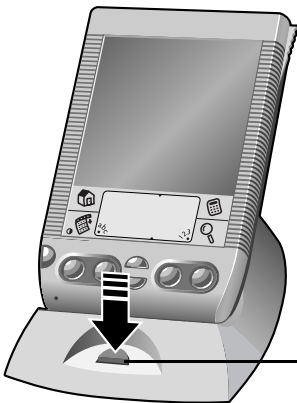

**HotSync
button**

4. From the Select User dialog box, choose the user name you assigned to your handheld.

The HotSync Progress dialog box appears and synchronization begins.

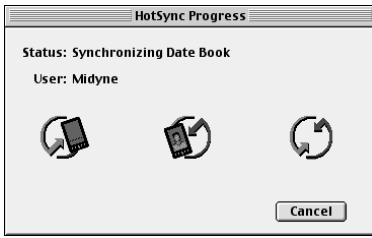

5. Wait for a message on your handheld indicating that the process is complete.

After the HotSync process is complete, you can remove your handheld from the cradle.

Categorizing records

Categorize records in the Address, To Do List, Memo Pad, and Expense applications so that they are grouped logically and are easy to review. (You can also categorize applications. See “Using the Applications Launcher” in Chapter 3 for more information.)

When you create a record, your handheld automatically places it in the category that is currently displayed. If the category is All, your handheld assigns it to the Unfiled category. You can leave an entry as Unfiled or assign it to a category at any time.

System-defined and user-defined categories

By default, your handheld includes system-defined categories, such as All and Unfiled, and user-defined categories, such as Business and Personal.

You cannot modify the system-defined categories, but you can rename and delete the user-defined categories. In addition, you can create your own user-defined categories. You can have a maximum of 15 user-defined categories in each application.

Address contains the QuickList user-defined category, in which you can store the names, addresses, and phone numbers you might need in emergencies (doctor, fire department, lawyer, etc.).

Expense contains two user-defined categories, New York and Paris, to show how you might sort your expenses according to different business trips.

Note: The illustrations in this section come from Address, but you can use these procedures in all the applications in which categories are available. Categories are not available in Date Book and Date Book Plus.

To move a record into a category:

1. Select the record you want to categorize.
2. In Address only: Tap Edit.
3. Tap Details.
4. Tap the Category pick list to display the list of available categories.



5. Select the category for the record.
6. Tap OK.

To display a category of records:

1. Tap the category pick list in the upper-right corner of the list screen.

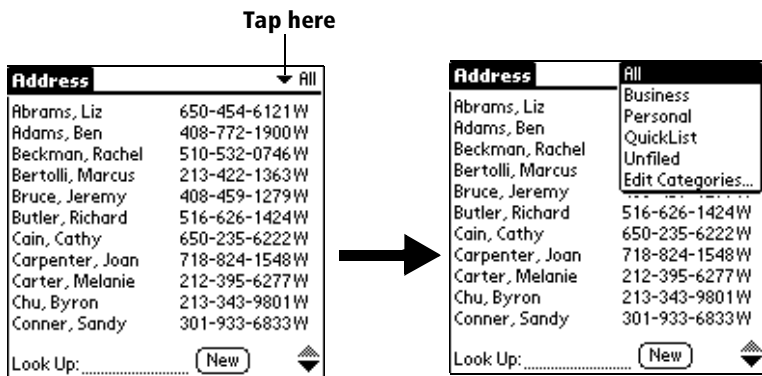

2. Select the category you want to view.

The list screen now displays only the records assigned to that category.

Tip: Pressing an application button on the front panel of the handheld toggles through all the categories of that application.

To define a new category:

1. Tap the category pick list in the upper-right corner of the screen.

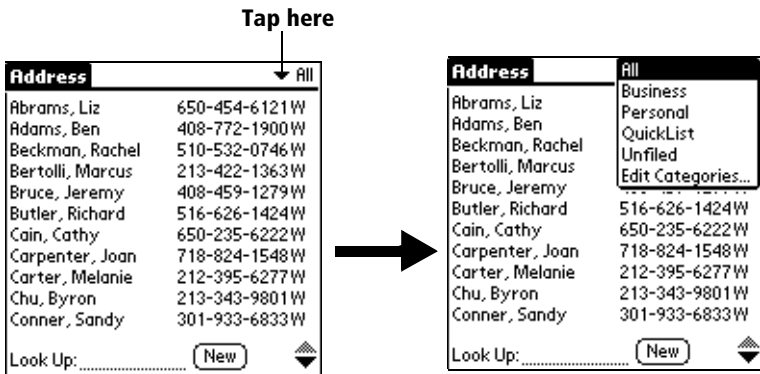

2. Tap Edit Categories.
3. Tap New.



4. Enter the name of the new category, and then tap OK.



5. Tap OK.

You can assign any of your records to the new category.

To rename a category:

1. Tap the category pick list in the upper-right corner of the screen.
2. Tap Edit Categories.
3. Select the category that you want to rename, and then tap Rename.



4. Enter the new name for the category, and then tap OK.



5. Tap OK.

Tip: You can group the records in two or more categories into one category by giving the categories the same name. For example, if you change the name of the Personal category to Business, all records formerly in the Personal category appear in the Business category.

Finding records

Your handheld offers several ways to find information quickly:

- **All applications:** Find locates any text that you specify, always starting with the current application.
- **Date Book, Date Book Plus, To Do List, Memo Pad:** Phone Lookup displays the Address list screen and lets you add the information that appears in this list to a record.
- **Address:** The Look Up line lets you enter the first letters of a name to scroll immediately to that name.
- **Expense:** Lookup displays the names in your Address list that have data in the Company field. You can add these names to a list of attendees associated with an Expense record.

Looking up Address records

When working with Address, the scroll buttons on the front panel of the handheld makes it easy to navigate among your address entries.

- In the Address list screen, the scroll buttons move up or down an entire screen of records. If you hold down a scroll button, you accelerate the scrolling and display every third screen.
- In the Address View screen, the scroll buttons move to the previous or next address record.

You can also use the Address Look Up feature to quickly scroll to any of your Address entries.

To look up an Address record:

1. Display the Address list screen.
2. Enter the first letter of the name you want to find.

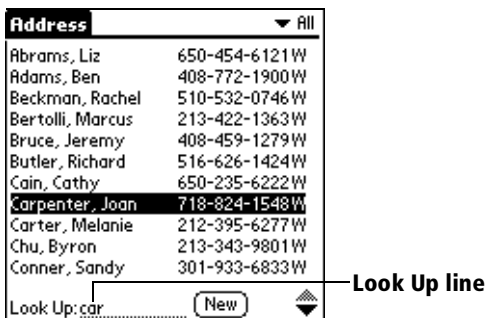

The list scrolls to the first entry that begins with that letter. If you write another letter, the list scrolls to the first entry that starts with those *two* letters. For example, writing an “s” scrolls to “Sands,” and writing “sm” scrolls further to “Smith.” If you sort the list by company name, the Look Up feature scrolls to the first letter of the company name.

3. Tap the record to view its contents.

Using Find

You can use Find to locate any text that you specify, in any application.

To use Find:

1. Tap the Find icon .

Tip: If you select text in an application before you tap Find, the selected text automatically appears in the Find dialog box.

2. Enter the text that you want to find.

Find is *not* case-sensitive. For example, searching for the name “davidson” also finds “Davidson.”

Find locates any word that begin with the text you enter. For example, searching for “plan” finds “planet,” but not “airplane.”

3. Tap OK.

Find searches for the text in all records and all notes.

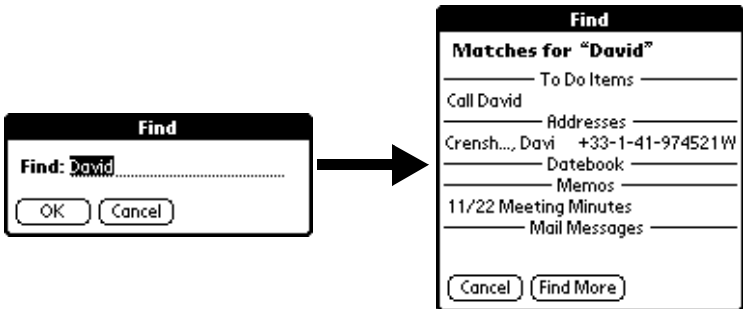

As your handheld searches for the text, you can tap Stop at any time. You may want to do this if the entry you want appears before your handheld finishes the search. To continue the search after you tap Stop, tap Find More.

4. Tap the text that you want to review.

Using Phone Lookup

Phone Lookup displays the Address list screen and lets you add the information that appears in this list to a record.

To use Phone Lookup:

1. Display the record in which you want to insert a phone number. The record can be in Date Book, Date Book Plus, To Do List, or Memo Pad.
2. Tap the Menu icon .
3. Tap Options, and then tap Phone Lookup.
4. Begin to spell the last name of the name you want to find.

The list scrolls to the first record in the list that starts with the first letter you enter. Continue to spell the name you're looking for, or when you see the name, tap it.



5. Tap Add.

The name you selected, along with the other information associated with it, is pasted into the record you selected in step 1.

Phone Lookup tips

Write the Graffiti Command stroke “/L” to activate the Phone Lookup feature. You can also activate it in the following circumstances:

- **While entering text:** For example, to insert the full name and phone number for someone with the last name “Williams,” write the Graffiti characters for “Wi” and then the Phone Lookup Command stroke “/L.” Assuming you have only one Address record that begins with “Wi,” your handheld inserts the full name “Fred Williams” (and its associated information). If you have more than one name that begins with “Wi,” the Phone Lookup screen appears and highlights the first record that begins with “Wi.”

- **For selected text:** Drag to highlight the text, and then write the Phone Lookup Command stroke “/L.” Your handheld replaces the selected text and adds the name and its associated information.

Looking up names to add to expense records

In Expense, Lookup displays the names in your Address list that have data in the Company field. You can add these names to a list of attendees associated with an Expense record.

To add names to an Expense record:

1. Tap the Expense record to which you want to add names.
2. Tap Details.



3. Tap Who.

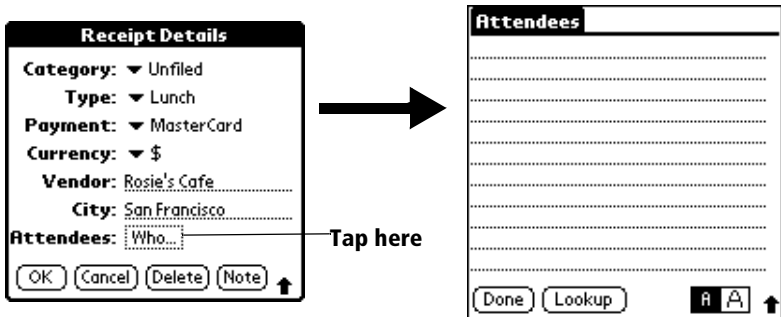

4. Tap Lookup.

The Attendees Lookup screen displays all the names in your Address list that have data in the Company field.

5. Select the name you want to add, and then tap Add.

The name appears in the Attendees screen.

6. Repeat steps 4 and 5 to add more names.
7. Tap Done, and then tap OK.

Sorting lists of records

You can sort lists of records in various ways, depending on the application. Sorting is available in applications that have list screens: Address, To Do List, Memo Pad, and Expense.

Note: You can also assign records to categories. See “Categorizing records” earlier in this chapter.

To sort records in To Do List and Expense:

1. Open the application to display the list screen.
2. Tap Show.
3. Tap the Sort by pick list and select an option.
4. Tap OK.

To sort records in Address and Memo Pad:

1. Open the application to display the list screen.
2. Tap the Menu icon .
3. Tap Options, and then tap Preferences.

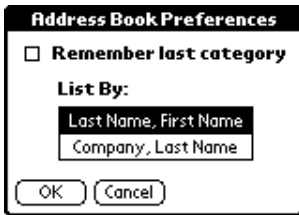

Address

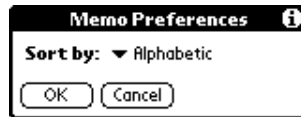

Memo Pad

4. Do one of the following:
 - Address:** Tap the setting you want.
 - Memo Pad:** Tap the Sort by pick list and select Alphabetic or Manual.
5. Tap OK.

To sort the Memo list manually, tap and drag a memo to a new location in the list.

Note: To make the list of your memos appear in Palm Desktop software as you manually sorted it on your handheld, open Memo Pad in Palm Desktop software and click List by. Then select Order on handheld.

Making records private

In all basic applications, except Mail and Expense, you can make individual records private. Private records remain visible and accessible, however, until you select the Security setting to hide or mask all private records. See “Security” in Chapter 3 for more information.

Hiding and masking private records

You can hide records that you mark as private. When you hide records, they do not appear anywhere in the application. When you mask records, a visual placeholder appears where the record would normally appear. If you define a password, you must enter it to display private records.

To make a record private:

1. Display the entry that you want to make private.
2. Tap Details.
3. Tap the Private check box to select it.
4. Tap OK.

To hide or mask all private records:

1. Make sure the records you want to mask are marked private.
2. Tap the Applications icon .
3. Tap Security.
4. Tap the Current Privacy pick list.

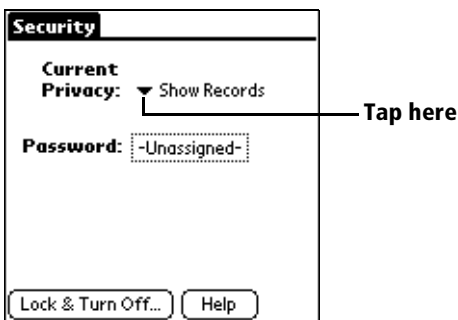

5. Tap either Hide Records or Mask Records.
6. Tap OK to confirm that you want to change the security setting.

To display all private records:

1. Tap the Applications icon .
2. Tap Security.
3. Tap the Current Privacy pick list.

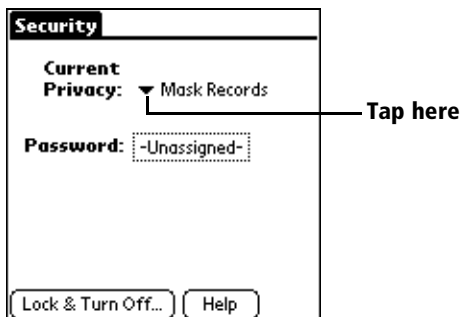

4. Tap Show Records.

If you do not have a password, private records become visible.

If you have a password, the Show Private Records dialog box appears. Enter your password in this dialog box, and tap OK.

To display a specific masked record:

1. Open the application that contains the record you want to view.
2. Tap the shaded bar that masks the record.

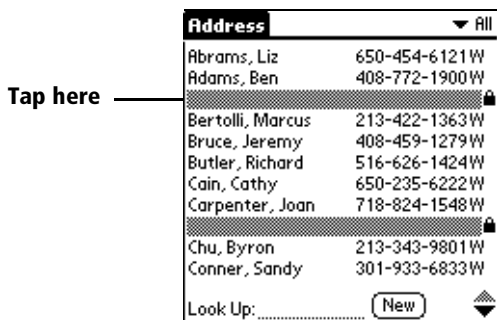

Note: If you have a password, you must enter your password and tap OK to view the record.

To display all private records in a specific application:

1. Open the application in which you want to display the records.
2. Tap the Menu icon .

3. Tap Options, and then tap Security.
4. Tap the Current Privacy pick list.



5. Tap Show Records.
6. Tap OK.

Attaching notes

In all basic applications except Memo Pad, you can attach a note to a record. A note can be up to several thousand characters long. For example, for an appointment in Date Book Plus, you can attach a note with directions to the location.

To attach a note to a record:

1. Display the entry to which you want to add a note.
2. In Address only: Tap Edit.
3. Tap Details.
4. Tap Note.
5. Enter your note.
6. Tap Done.

A small note icon appears at the right side of any item that has a note.

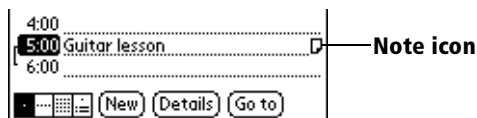

To review or edit a note:

1. Tap the Note icon .

To delete a note:

1. Tap the Note icon .
2. Tap Delete.
3. Tap Yes.

Choosing fonts

In all basic applications except Expense, you can change the font style to make text easier to read. You can choose a different font style for each application.

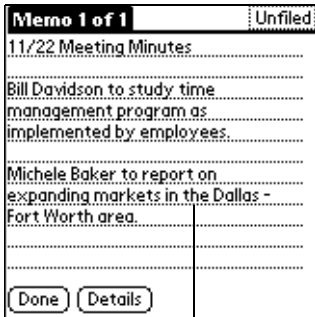

Small font



Large font



Bold font

To change the font style:

1. Open an application.
2. Tap the Menu icon .
3. Tap Options, and then tap Font.
4. Tap the font style you want to use.

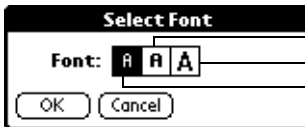

- Tap here for bold font
- Tap here for large font
- Tap here for small font

5. Tap OK.

Chapter 6

Application Specific Tasks

This chapter is organized by application and gives instructions on how to do tasks that are specific to each of the following applications:

- Date Book
- Date Book Plus
- Address
- To Do List
- Memo Pad
- Calculator
- CityTime
- Expense

Date Book

When you open Date Book, the screen shows the current date and a list of times for a normal business day.

Scheduling an event

A record in Date Book is called an “event.” An event can be any kind of activity that you associate with a day. You can enter a new event on any of the available time lines.

When you schedule an event, its description appears on the time line, and its duration is automatically set to one hour. You can easily change the start time and duration for any event.

Note: It’s possible to schedule events that overlap, but Date Book makes it easy to find such conflicts. See “Spotting event conflicts” later in this chapter.

You can also schedule events in your Date Book that occur on a particular date but have no specific start or end times, such as birthdays, holidays, and anniversaries. These are referred to as “untimed events.” Untimed events appear at the top of the list of times, marked with a diamond. You can have more than one untimed event on a particular date.

You can also schedule a repeating event, such as a weekly meeting, and continuous events, such as a three-day conference or a vacation.

To schedule an event for the current day:

1. Tap the time line that corresponds to the beginning of the event.

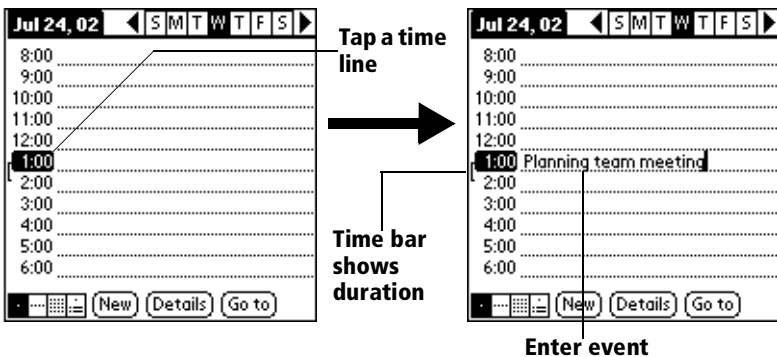

2. Enter a description of the event. You can enter up to 255 characters.

- If the event is one hour long, skip to step 7. If the event is longer or shorter than an hour, tap the time of the event to open the Set Time dialog box.

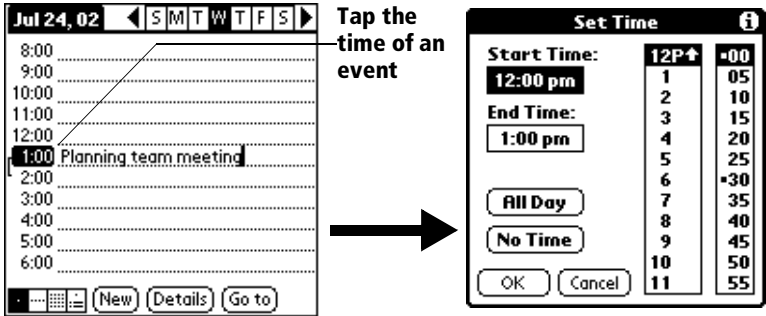

Tip: You can also open the Set Time dialog (to select a start time) by making sure no event is selected, and then writing a number on the number side of the Graffiti writing area.

- Tap the time columns on the right side of the Set Time dialog to set the Start Time.

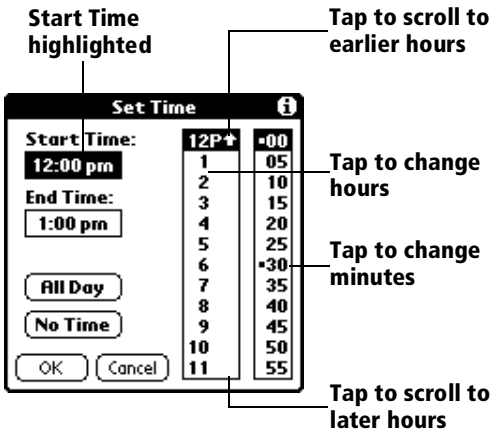

- Tap the End Time box, and then tap the time columns to set the End Time.
- Tap OK.
- Tap a blank area of the screen to deselect the event. A vertical line appears next to the time, indicating the duration of the event.

To schedule an event for another day:

1. Select the date you want for the event by doing one of the following:
 - Tap the day of the week that you want in the date bar at the top of the screen. If necessary, tap the Previous week or Next week scroll arrows to move to another week.

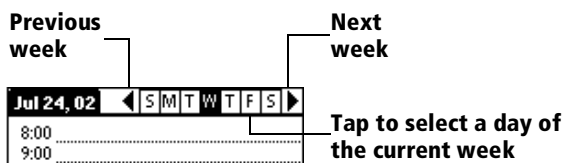

Tip: You can also use the scroll buttons on the front panel of your handheld to move forward or backward one day at a time.

- Tap Go To at the bottom of the screen to open the Go to Date dialog box. Select a date by tapping a year, month, and day in the calendar.

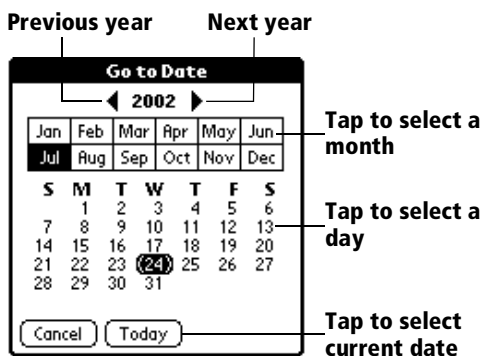

Tip: In the Go to Date dialog box, you can also use the scroll buttons on the front panel of your handheld to move forward or backward one month at a time.

2. After you locate the date, follow the steps for scheduling an event for the current day.

To schedule an untimed event:

1. Select the date that you want for the event as described in "To schedule an event for another day."
2. Tap New.
3. Tap OK, so that no start or end times are defined for the new event.

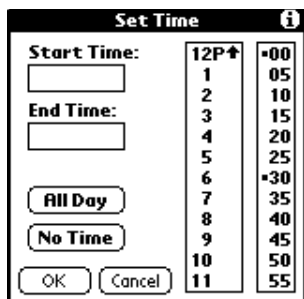

Tip: You can also create a new untimed event by making sure no event is selected and then writing letters in the Graffiti writing area.

4. Enter a description of the event.

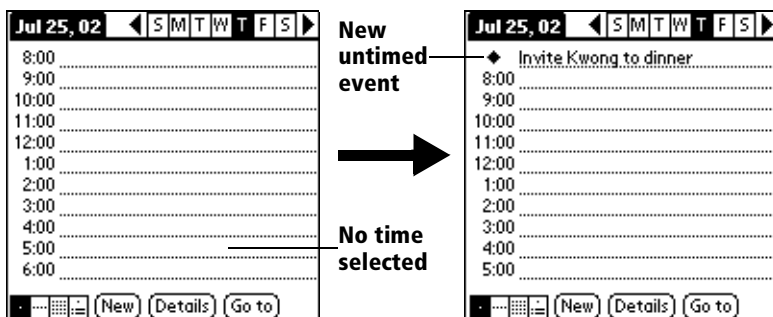

5. Tap a blank area on the screen to deselect the untimed event.

Note: If you create an event and decide later that there is no particular start or end time, you can easily change it to an untimed event. Tap the time of the event in the Date Book screen, tap No Time, and then tap OK.

Rescheduling an event

You can easily make changes to your schedule with your handheld.

To reschedule an event:

1. Tap the event you want to reschedule.
2. Tap Details.
3. To change the time, tap the Time box and select a new time.
4. To change the date, tap the Date box and select a new date.
5. Tap OK.

Setting an alarm for an event

The Alarm setting enables you to set an audible alarm for events in your Date Book. You can set an alarm to sound minutes, hours, or days before an event. The default Alarm setting is 5 minutes before the time of the event, but you can change this to any number of minutes, hours, or days.

When you set an alarm, this icon  appears to the far right of the event with the alarm. When the alarm tone sounds, a reminder message also appears onscreen.

To set an alarm for an event:

1. Tap the event to which you want to assign an alarm.
2. Tap Details.
3. Tap the Alarm check box to select it.

The default setting, 5 Minutes, appears.

4. Tap the pick list to select Minutes, Hours, or Days.
5. Select the 5 and enter any number from 0 to 99 (inclusive) as the number of time units.

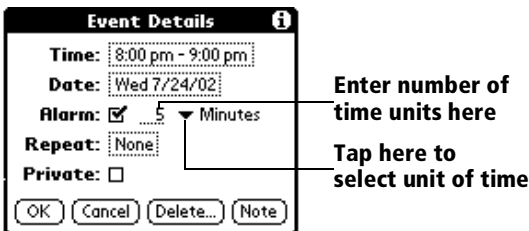

6. Tap OK.

Alarm for untimed events: You can set a silent alarm for an untimed event. In this case, the alarm triggers at the specified period of minutes, hours, or days before midnight (beginning) of the day of the untimed event. No audible alarm sounds for an untimed event; instead, the reminder message appears onscreen.

For example, you set an alarm for an untimed event that occurs on February 4th. If the alarm is set for 5 minutes, the reminder message appears at 11:55 PM on the night of February 3rd. The reminder remains onscreen until you turn on your handheld and tap OK to dismiss it.

To dismiss the alarm using the snooze option:

- When the alarm Reminder dialog box appears, tap Snooze to delay the alarm for five-minutes.



Note: Each time you tap Snooze, you dismiss the alarm for an additional five-minute period.

Scheduling repeating or continuous events

The Repeat function lets you schedule events that recur at regular intervals or extend over a period of consecutive days.

A birthday is a good example of an event that repeats annually. Another example is a weekly guitar lesson that falls on the same day of the week and the same time of day.

A business trip or a vacation is an example of a continuous event.

To schedule a repeating or continuous event:

1. Tap the event.

Typically, a continuous event is an untimed event.

2. Tap Details.

3. Tap the Repeat box to open the Change Repeat dialog box.

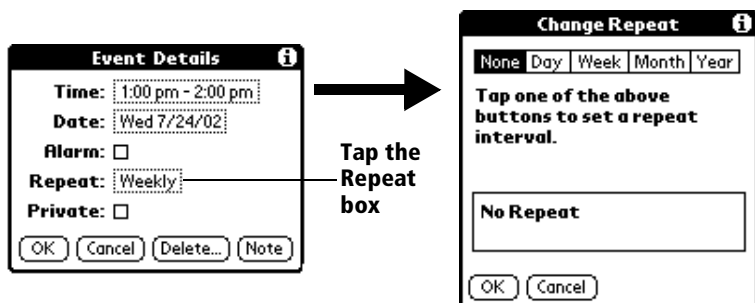

4. Tap Day, Week, Month, or Year to set how often event repeats.
For a continuous event, tap Day.
5. Enter a number that corresponds to how often you want the event to repeat on the Every line.
For example, if you select Month and enter the number 2, the event repeats every other month.
6. To specify an end date for the repeating or continuous event, tap the End on pick list and tap Choose Date. Use the date picker to select an end date.
7. Tap OK.

After you schedule a repeating or continuous event, this icon  appears to the far right of the event.

Changing and deleting repeating or continuous events

If you change or delete a repeating or continuous event you can apply the action to only the current event, to all instances of the event, or to the current event and instances that follow.

To change or delete repeating events:

1. Select the record you want to change or delete.
2. Tap Details.
3. Enter the change and tap OK, or tap Delete.
4. Tap one of the following:



Current. Changes or deletes only the current instance of the repeating event.

Future. Changes or deletes the current event and all future occurrences of this event.

All. Changes or deletes all past, current, and future occurrences of this event.

Considerations for repeating or continuous events

Keep the following points in mind:

- If you change the start date of a repeating event, your handheld calculates the number of days you moved the event. Your handheld then automatically changes the end date to maintain the duration of the repeating event.
- If you change the repeat interval (e.g., daily to weekly) of a repeating event, past occurrences (prior to the day on which you change the setting) are not changed, and your handheld creates a new repeating event.
- If you change the date of an occurrence of a repeating event (e.g., from January 14th to January 15th) and apply the change to All occurrences, the new date becomes the start date of the repeating event. Your handheld adjusts the end date to maintain the duration of the event. If you apply the change to Current or Future occurrences, past occurrences (prior to the day on which you change the setting) are not changed.
- If you change other repeat settings (e.g., time, alarm, private) of a repeating event and apply the change to Future occurrences, your handheld creates a new event. The start date of this new event is the day on which the setting is changed. Past occurrences (prior to the day of the change) are not changed.
- If you apply a change to a single occurrence of a repeating event (e.g., time), that occurrence no longer shows the Repeat icon .

Changing the Date Book view

In addition to displaying the calendar for a specific day, you can also display a whole week or month, as well as the current time.

Note: The Date Book Plus application includes additional calendar views and extended features. You can select Date Book Plus as your default Date Book application. See “Selecting the default Date Book” later in this chapter for details.

To cycle through Day, Week, and Month views:

- Press the Date Book application button repeatedly to display the next view.

To display the current time:

1. Tap and hold the stylus on the date in the date bar to display the current time.

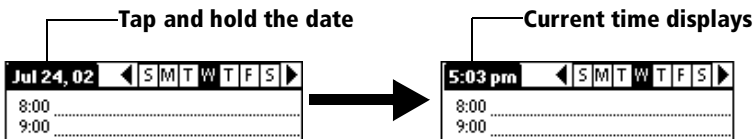

2. Drag the stylus below the date bar and then lift it.

Tip: If you lift the stylus while it is still on the date bar, the menu bar appears.

Working in Week View

Week View shows the calendar of your events for an entire week. This view lets you quickly review your appointments and available time slots. In addition, the graphical display helps you spot overlaps and conflicts in your schedule.

To display the Week View:

1. Tap the Week View button.



2. Tap the navigation controls to move forward or backward a week at a time, or to display details of an event.

Note: The Week View also shows untimed events and events that are before and after the range of times shown.

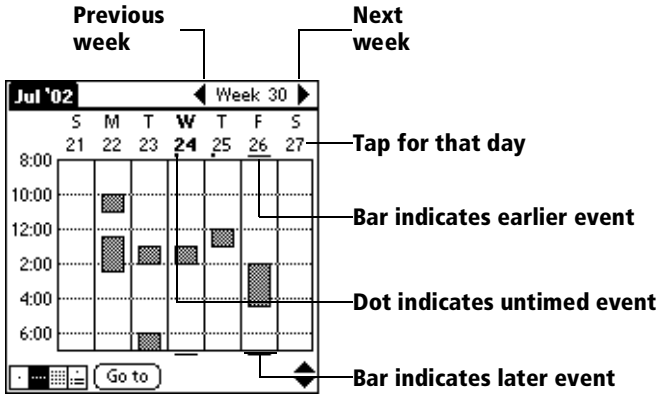

3. Tap an event to show a description of the event.

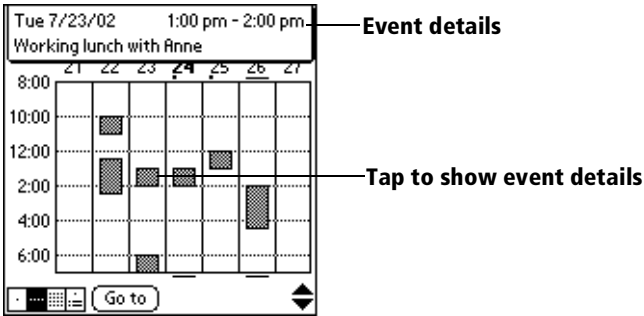

Tips for using Week View

Keep the following points in mind:

- To reschedule an event, tap and drag the event to a different time or day.
- Tap a blank time on any day to move to that day and have the time selected for a new event.
- Tap any day or date that appears at the top of the Week View to move directly to that day without selecting an event.
- The Week View shows the time span defined by the Start Time and End Time in the Date Book Preferences settings. If you have an event before or after this time span, a bar appears at the top or bottom of that day's column. Use the onscreen scroll arrows  to scroll to the event.

Working in Month View

The Month View screen shows which days have events scheduled. Dots and lines in the Month View indicate events, repeating events, and untimed events.

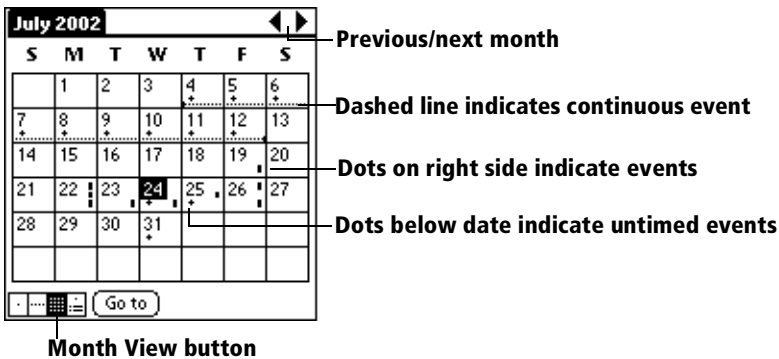

You can control the dots and lines that appear in the Month View. See “Options menu” later in this chapter.

Tips for using Month View

Keep the following points in mind:

- Tap a day in the Month View to display that day in the Day View.
- Tap the scroll arrows in the upper-right corner to move forward or backward a month.
- Tap Go to to open the date selector and select a different month.
- Use the scroll buttons on the front panel of your handheld to move between months. Press the upper half of the button to display the previous month, the lower half to display the next month.

Working in Agenda view

The Agenda view lets you view appointments, untimed events, and To Do items in a single screen. Although it is primarily a viewing option, you can also use the Agenda view to check off completed To Do items. To go to a Day View of any event on the Agenda view screen, simply tap the desired event.



Tips for using Agenda view

- Tap any appointment while in Agenda view to display the Day View of the appointment.
- Check off completed To Do items in the Agenda view, or click a description of an item to go directly into the To Do List application.

Spotting event conflicts

With the ability to define specific start and end times for any event, it's possible to schedule events that overlap (an event that starts before a previous event finishes).

An event conflict (time overlap) appears in the Week View as overlapping bars. The Day View displays overlapping brackets to the left of the conflicting times.

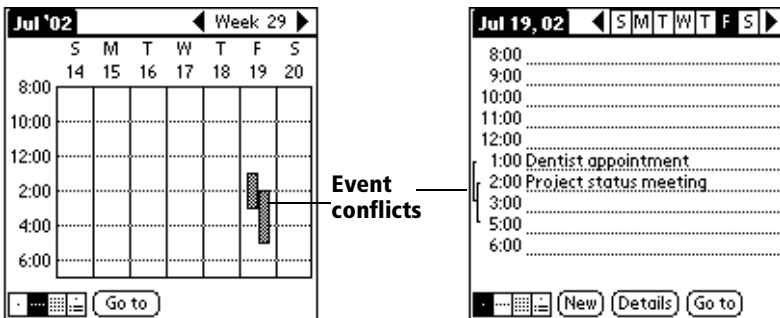

Date Book menus

Date Book menus are shown here for your reference, and Date Book features that are not explained elsewhere in this guide are described here.

See "Using menus" in Chapter 1 for information about choosing menu commands.

Record menu



Options menu

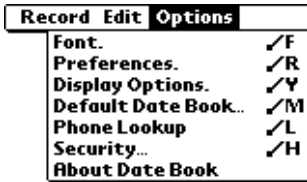

Day View

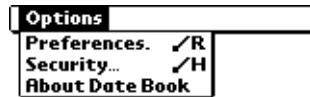

Week View

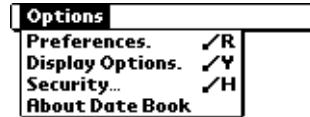

Month View

Display Options Enables you to change Date Book's appearance and which events display.



- **Show Time Bars.** Activates the time bars that appear in the Day View. The time bars show the duration of an event and illustrate event conflicts.
- **Compress Day View.** Controls how times appear in the Day View. When Compress Day View is off, all time slots display. When it is on, start and end times display for each event, but blank time slots toward the bottom of the screen disappear to minimize scrolling.
- **Month View settings.** These check boxes apply to the Month View of the Date Book. You can activate any or all of these settings to show that you have Timed, Untimed, or Daily Repeating events in the Month View *only*.

Preferences



- **Start/End Time.** Defines the start and end times for Date Book screens. If the time slots you select do not fit on one screen, you can tap the scroll arrows  to scroll up and down.
- **Alarm Preset.** Automatically sets an alarm for each new event. The silent alarm for untimed events is defined by minutes, days, or hours before midnight of the date of the event.
- **Alarm Sound.** Sets the tone of the alarm.
- **Remind Me.** Defines how many times the alarm sounds. The choices are Once, Twice, 3 Times, 5 Times, and 10 Times.
- **Play Every.** Defines how often the alarm sounds. The choices are Minute, 5 minutes, 10 minutes, and 30 minutes.

About Date Book

Shows version information for Date Book.

Date Book Plus

In addition to all the standard Date Book features, Date Book Plus provides three extra views: Week View with Text, Year View, and List View. Date Book Plus also includes useful features such as floating events, To Do List integration, the Daily Journal, and templates.

This section describes the views and features which are unique to Date Book Plus. See “Date Book” earlier in this chapter for information on the standard Date Book features.

Working in Week View with Text

The Week View with Text shows an entire week with a description of each scheduled event. This view can display one or two weeks at a time and can include To Do items that are due on the dates shown.

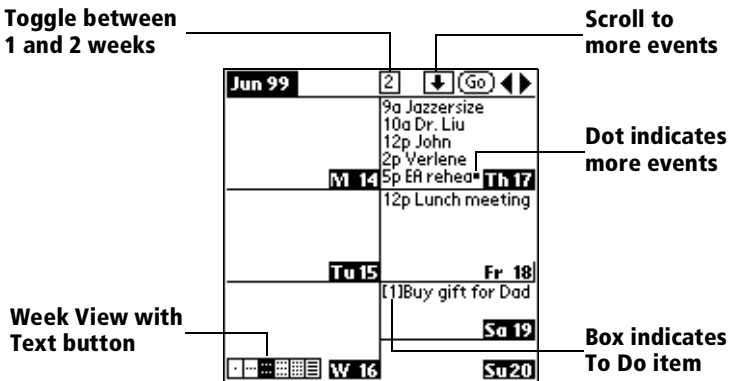

Tips for using Week View with Text

Keep the following points in mind:

- Tap a day to display that day in the Day View.
- Tap the scroll arrows in the upper-right corner to move forward or backward a week. You can also use the scroll buttons on the front panel of your handheld.
- Tap Go to open the date selector and select a different week or a specific date.
- Tap the number of weeks to toggle between a one week view and a two week view.

Working in Year View

The Year View shows an overview of your calendar for an entire year.

Description of event
on selected date

Indicates
selected date

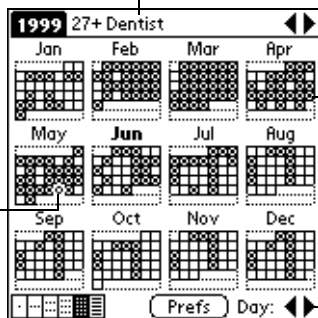

Dot indicates
scheduled events

Scroll to
other days

Year View button

Tips for using Year View

Keep the following points in mind:

- Tap a day to display events for that day in the title bar. A minus sign indicates only one event is scheduled on that day. A plus sign indicates multiple events are scheduled on that day.
- Tap the scroll arrows in the upper-right corner to move forward or backward a year. You can also use the scroll buttons on the front panel of your handheld.
- Tap the scroll arrows in the lower-right corner to move forward or backward a day.
- Tap Prefs to set display options.

Working in List View

The List View is a text oriented view that is integrated with To Do List. It displays a list of events and To Do items for the selected week(s).

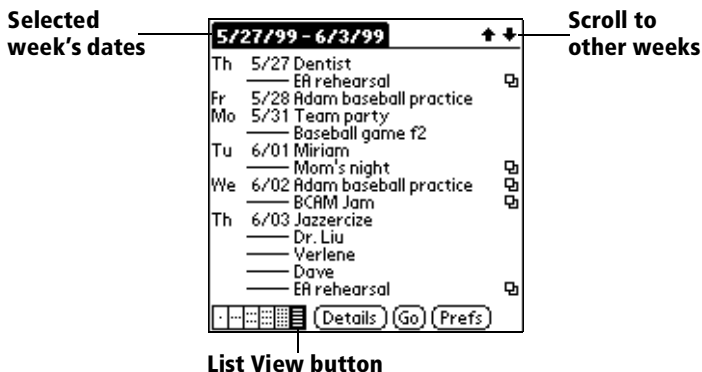

Tips for using List View

Keep the following points in mind:

- Tap a line to select it. The start and end time display briefly in the title bar. To redisplay the event details, tap to the left of the description.
- Tap the description of the selected line to display the event in Day View.
- Tap the scroll arrows in the upper-right corner to move forward or backward a week. You can also use the scroll buttons on the front panel of your handheld.
- Tap Go to open the date selector and select a different week or a specific date.
- Tap Prefs to set display options.

Working with floating events

Date Book Plus can include events that are a combination of a To Do item and a Date Book event. These events are called "floating events." Floating events are not assigned to a specific date, but can still be timed or untimed, can have alarms, and can repeat. If a floating event is not completed by midnight, it automatically advances to the next day until you mark it complete.

You can distinguish a floating event from an integrated To Do item by the circle that appears next to the floating event (in place of the To Do item priority number and check box). Floating events appear in alphabetical order at the top of the Day View screen between any integrated To Do items and untimed events.

To create a floating event:

1. Tap the Day View button.
2. Tap New and select Floating Event from the list.

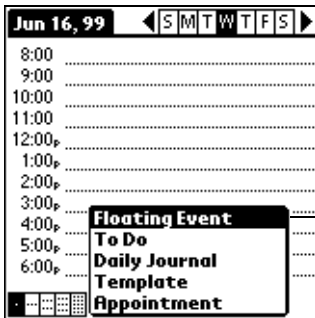

3. Enter a description of the event.
4. Tap a blank area on the screen to deselect the floating event.

To mark a floating event complete:

- Tap the circle to the right or left of the event.

Tips for using floating events:

- To prioritize floating events, enter a number followed by a space or dash as the first few characters of the description.
- To convert an existing event to a floating event, select the event, tap Details and select Float as the Type.
- When you complete a repeating floating event, it marks only the current occurrence of the event as complete.
- Avoid scheduling a floating event that repeats daily. These events can accumulate quickly unless you complete them each day.
- When viewing a floating event in a desktop application, the Note field will contain a series of characters: ##f@@@@@ for an incomplete event and ##c@@@@@ for a complete event. **Do not remove or edit these characters.**

Working with To Do items

Date Book Plus can create and display To Do items. To Do items appear in priority order at the top of the Day View screen.

To create To Do items in Date Book Plus:

1. Tap the Day View button.
2. Tap New and select To Do from the list.

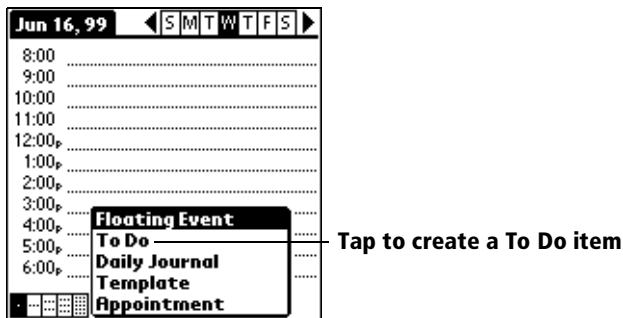

3. Enter a description of the To Do item.
4. Tap a blank area on the screen to deselect the item.

To mark a To Do item complete:

- Tap the check box next to the item.

Tips for using To Do items:

- When you create a To Do item in Date Book Plus, the priority and category are based on the settings in the Create Options dialog box. See "To Do Preferences" later in this chapter for details.
- If a To Do item does not appear in Date Book Plus, confirm that the category assigned to the item is selected. See "To Do Preferences" later in this chapter for more information.
- If you do not complete a To Do item on or before the due date, then an ! (exclamation mark) appears next to the item as a reminder that it is overdue.

Using the Daily Journal

You can use the Daily Journal feature to record events as they occur. Events are recorded with automatic time-stamping as Date Book Plus Notes so they do not clutter your schedule. The Daily Journal is especially useful for tracking activities such as sales calls, start and end times for consulting or other work, or keeping a record of how you spend your time at the office.

To create a Daily Journal entry:

1. Tap the Day View button.
2. Tap New and select Daily Journal from the list.

Date Book Plus creates an untimed event, opens a Note for this event, and inserts the current time. If you've already started a journal for the current day, Date Book Plus opens the existing journal and inserts a new entry.

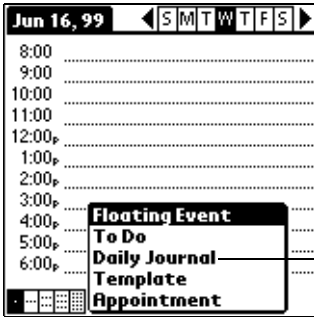

Tap to create a Daily Journal

3. Enter a description for the journal entry.
4. Tap Done.

Using templates

You can use templates to create a list of standard events. You can then select an event from this list and add it to your calendar. Since Date Book Plus saves all the event attributes, including alarms and notes, templates can really save you time when entering reminder notices or events that recur on different days and times.

To create a template:

1. Select the event you want to save as a template.
2. Tap the Menu icon .
3. Tap Record, and then tap Create Template.

To schedule a template event:

1. Go to the date on which you want to schedule the event.
2. Tap the time line that corresponds to the beginning of the event.
3. Tap the Day View button.
4. Tap New and select Template from the list.



Tap to create an event from a template

5. Select the event from the Appointment Templates list.
6. Tap OK.

Using snooze alarms

When you set alarms in Date Book Plus, the Reminder & Snooze dialog box appears in place of the standard reminder message. You can use this dialog box to reset the alarm to sound in a specified period of time.



Selecting the default Date Book

The default Date Book is the application that appears when you press the Date Book button on the front of your handheld. By default, this is the Date Book Plus application. If you prefer, you can select Date Book as your default application.

To select the default Date Book:

1. Tap the Menu icon .
2. Tap Options, and then tap Default Date Book.
3. Tap Date Book or Date Book+.
4. Tap OK.

Date Book Plus menus

Date Book Plus menus are shown here for your reference, and Date Book Plus features that are not explained elsewhere in this guide are described here.

See "Using menus" in Chapter 1 for information about choosing menu commands.

Record menu

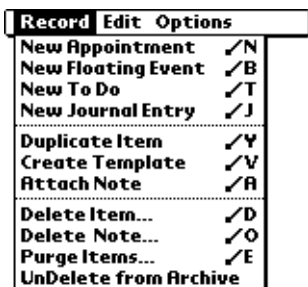

New To Do Creates a new To Do item and adds it to your Date Book Plus and To Do List database.

Duplicate Item Creates a copy of the selected event and opens the Details dialog box for the new event.

UnDelete from Archive Restores the last event you deleted from Date Book Plus (provided it was stored in the Archive file). You can select this command repeatedly to restore additional events.

Options menu



Day View

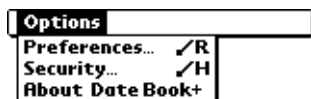

Week View

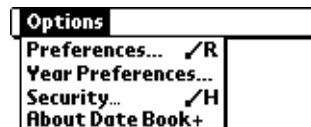

Year View

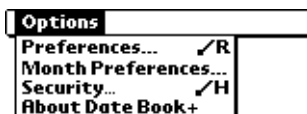

Month View

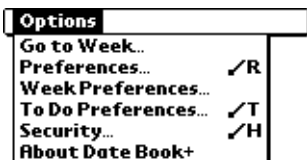

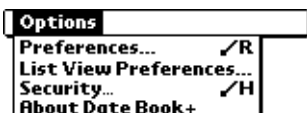

Week View with Text

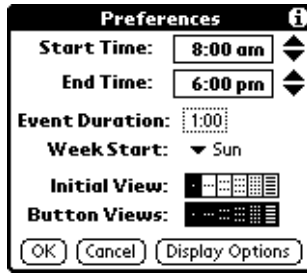

List View

Preferences



- **Start/End Time.** Defines the start and end times for Date Book Plus screens. If the time slots you select do not fit on one screen, you can tap the scroll arrows  to scroll up and down.
- **Event Duration.** Defines the default duration for new events.
- **Week Start.** Defines the first day of the week. This setting overrides the System Preferences setting for all Date Book Plus views.
- **Initial View.** Defines the view that appears when you start Date Book Plus.
- **Button Views.** Defines which views display when you press the Date Book button repeatedly. By default, all views appear.
- **Display Options.** Opens the Display Options dialog box where you can define the following options:

Display Options



- **Show Time Bars.** Activates the time bars that appear in the Day View. The time bars show the duration of an event and illustrate event conflicts
- **Compress Day View.** Controls how times appear in the Day View. When Compress Day View is off, all time slots display. When it is on, start and end times display for each event, but blank time slots toward the bottom of the screen disappear to minimize scrolling.
- **Show PM Label.** Displays a “p” after PM times.
- **Hide End Times.** Removes all time bars and end times from the display.
- **Scroll Before Day Move.** Determines whether the front panel scroll buttons will scroll up and down within the current day before scrolling to the previous or next day.
- **Auto-scroll Time.** Displays events based on the time of day when the Day View contains more than one screen of information.
- **Float Advance at Midnight.** Advances floating events to the next day at midnight of the current day.
- **Hide Completed Floating Events.** Removes completed floating events from the Date Book Plus display.

Alarm Preferences



- **Alarm Sound.** Sets the tone of the alarm.
- **Snooze Sound.** Sets the tone of the snooze alarm.
- **Remind Sound.** Sets the tone of the reminder alarm. The reminder alarm sounds when the snooze alarm is not acknowledged.
- **Play Sound.** Defines how many tones the alarm emits before it stops. The choices are Once, Twice, 3 Times, 5 Times, 10 Times, and 100 Times.
- **Repeat Alarm.** Defines how many times the alarm repeats when it is not acknowledged. The choices are Once, Twice, 3 Times, 5 Times, and 10 Times.
- **Every.** Defines how often the alarm sound repeats. The choices are Minute, 5 minutes, 10 minutes, and 30 minutes.
- **Alarm Preset.** Automatically sets an alarm for each new event. The silent alarm for untimed events is defined by minutes, days, or hours before midnight of the date of the event.

To Do Preferences

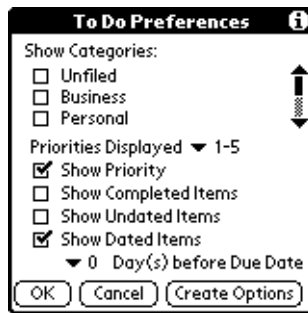

- **Show Categories.** Displays the To Do items in the categories you select.
- **Priorities Displayed.** Displays To Do items with the selected priority level. The choices are 1 only, 1-2, 1-3, 1-4, and 1-5.
- **Show Priority.** Displays the priority level for To Do items.
- **Show Completed Items.** Displays completed To Do items.
- **Show Undated Items.** Shows all To Do items that have not been assigned a due date.
- **Show Dated Items.** Shows all To Do items that have been assigned a due date.
- **Days before Due Date.** Defines the number of days before the due date that an item will appear in Day View as a To Do item.
- **Create Options.** Opens the Create Options dialog box where you can select the default priority and category for To Do Items you create in Date Book Plus.

Go to Week

Enables you to jump to a specific week by tapping the week number in the current year.

Week Preferences



- **Time Format.** Defines the format of the time display. The choices are No Time, 11p, 11:30p, 23, 23:30.
- **Display To Do.** Defines where To Do items will appear on the Date Book Plus screen. The choices are Top, Bottom, and Hide.
- **Week Start.** Defines the first day of the week for Week View with Text.
- **Wordwrap Single Entry.** Wraps text in cells that contain a single event to display as much text as will fit in the cell.
- **Hide Untimed Floating Events.** Removes untimed floating events from the Week View with Text display.
- **Show Journal.** Displays a Daily Journal entry.
- **Include Week Numbers in Title.** Displays the selected week number in the title bar.

Month Preferences



- **Show Timed Events.** Displays events that you assigned to a specific time.
- **Show Untimed Events.** Displays events that you assigned to a date, but did not assign to a specific time.
- **Show Daily Repeating Events.** Displays events that repeat each day.
- **Include Week Numbers in Title.** Displays week numbers in the title bar for the first and last weeks in the month.
- **Show Zero Duration Events.** Displays events that have no duration in the Month View display.

Year Preferences



- **Hide Floating and Done Items.** Removes floating events and completed To Do items from the Year View display.
- **Hide Untimed Events.** Removes untimed events from the Year View display.
- **Hide Zero Duration Events.** Removes events without a duration from the Year View display.
- **Hide Events <.** Removes events that are shorter than the time you specify from the Year View display. The choices are 0.5, 1, 2, 4, 8, and 12.
- **Hide Daily Repeating Events.** Removes events that repeat daily from the Year View display.

List View Preferences

List Preferences ⓘ

Date Book:

Appt Float Done

Alarms Only

Repeat events only appear once

To Do: ▼ All

Filter by Text

Find:

Show: Day Name Time

OK Cancel

- **Date Book.** Determines which type of events appear in the List View display. The choices are: Appt, Float, Done, Alarms Only, and Repeat events only appear once.
- **To Do.** Determines which type of To Do items appear in the List View display. The choices are All, Not Complete, Complete, and None. If you choose either Not Complete or Complete, you also have the following choices: Dated & Undated, Dated only, and Undated only.
- **Filter by Text.** Displays events that contain the text you enter in this field and hides events that do not contain this text.
- **Show.** Determines the type of information that will appear for each event. The choices are Day Name and Time.

About Date Book+

Shows version information for Date Book Plus.

Address

Address is the application in which you store name and address information about people or businesses.

Creating an Address entry

A record in Address is called an “entry.” You can create entries on your handheld, or you can use Palm Desktop software to create entries on your computer and then download the entries to your handheld with your next HotSync operation.

Palm Desktop software also has data import capabilities that enable you to load database files into Address on your handheld.

See “Importing data” in Chapter 2 and Palm Desktop online Help for more information.

To create a new Address entry:

1. Press the Address application button  on the front of your handheld to display the Address list.
2. Tap New.

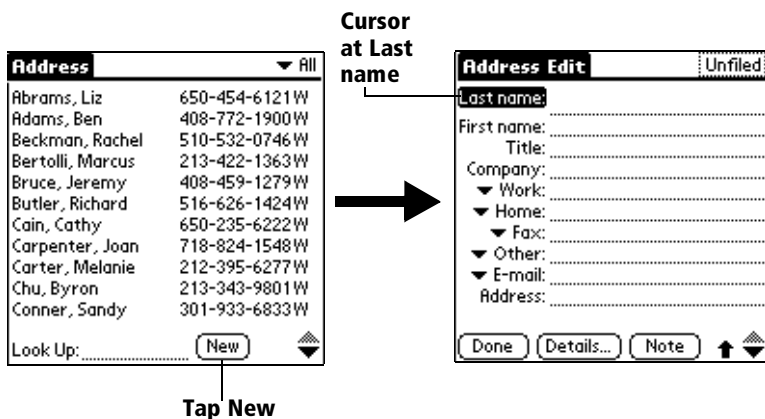

3. Enter the last name of the person you want to add to your Address list.

Note: The handheld automatically capitalizes the first letter of each field (except numeric and e-mail fields). You do not have to use the Graffiti capital stroke to capitalize the first letter of the name.

- Use the Next Field Graffiti stroke to move to the First Name field.



Tip: You can also move to any field by tapping it directly.

- Enter the person's first name in the First Name field.
- Enter the other information that you want to include in this entry.
- Tap the scroll arrows  to move to the next page of information.
- After you finish entering information, tap Done.

Tap Done

Tip: To create an entry that always appears at the top of the Address list, begin the Last name or Company field with a symbol, as in *If Found Call*. This entry can contain contact information in case you lose your handheld.

Duplicating an entry

You can duplicate existing entries, which can be helpful when you want to enter multiple people from a single organization. When you duplicate an entry, the word *Copy* appears next to the name in the First Name field.

To duplicate an entry:

- From the Address list, tap a name you want to duplicate.
 - Tap the Menu icon .
 - Tap Record, and then tap Duplicate Record.
 - Edit the entry as necessary.

Selecting types of phone numbers

You can select the types of phone numbers or e-mail addresses that you associate with an Address entry. Any changes you make apply only to the current entry.

To select other types of phone numbers in an entry:

1. Tap the entry that you want to change.
2. Tap Edit.
3. Tap the pick list next to the label you want to change.

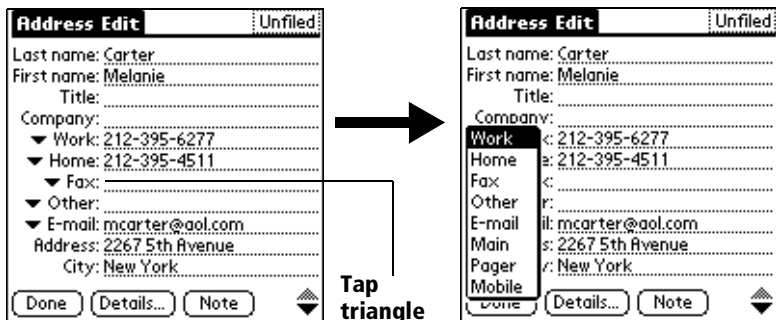

4. Select a new label.

Changing Address Entry details

The Address Entry Details dialog box provides a variety of options that you can associate with an entry.

To open the Address Entry Details dialog box:

1. Tap the entry whose details you want to change.
2. Tap Edit.
3. Tap Details.



4. Select any of the following settings:

Show in List Select which type of phone or other information appears in the Address list screen. Your options are Work, Home, Fax, Other, and E-mail.

Category Assign the entry to a category.

Private Hide this entry when Security is turned on.

Address menus

Address menus are shown here for your reference, and Address features that are not explained elsewhere in this guide are described here.

See “Using menus” in Chapter 1 for information about choosing menu commands.

The Record and Options menus differ depending on whether you’re displaying the Address list screen or the Address View screen.

Record menus

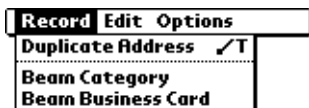

Address list

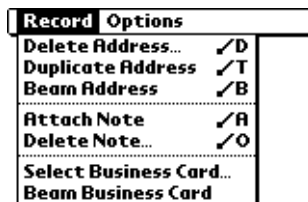

Address View

Options menus



Address list



Address View

Preferences

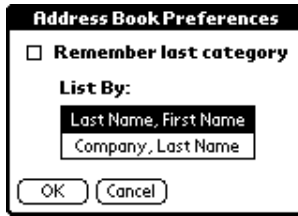

- **Remember last category.** Determines how Address appears when you return to it from another application. If you select this check box, Address shows the last category you selected. If you clear it, Address displays the All category.

Rename Custom Fields

These custom fields appear at the end of the Address Edit screen. Rename them to identify the kind of information you enter in them. The names you give the custom fields appear in all entries.



About Address Book

Shows version information for Address Book.

To Do List

A To Do item is a reminder of some task that you have to complete. A record in To Do List is called an “item.”

To create a To Do item:

1. Press the To Do List application button  on the front of your handheld to display the list of To Do items.
2. Tap New.

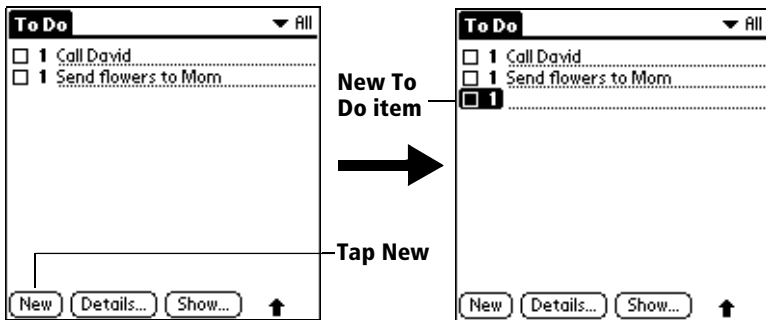

3. Enter the text of the To Do item. The text can be longer than one line.
4. Tap anywhere onscreen to deselect the To Do item.

Tip: If no To Do item is currently selected, writing in the Graffiti writing area automatically creates a new item.

Setting priority

The priority setting for items lets you arrange your To Do items according to their importance or urgency. The default setting is to arrange To Do items by priority and due date, with priority 1 items at the top. If you have a number of items in your list, changing an item’s priority setting may move its position in the list.

Note: When you create a new To Do item, its priority is automatically set to level 1, the highest (most important) level. If you select another item first, however, the item you create appears beneath the selected item and is given the same priority as the selected item.

To set the priority of a To Do item:

1. Tap the Priority number on the left side of the To Do item.

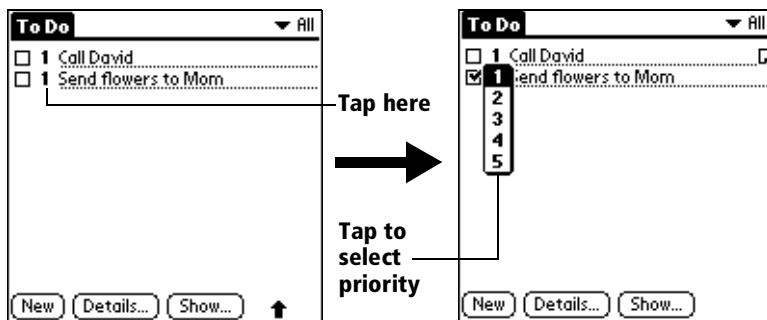

2. Tap the Priority number that you want to set (1 is most important).

Checking off a To Do item

You can check off a To Do item to indicate that you've completed it. You can set To Do List to record the date that you complete the To Do item, and you can choose to show or hide completed items. See "To Do Show Options" later in this chapter.

To check off a To Do item:

- Tap the check box on the left side of the item.

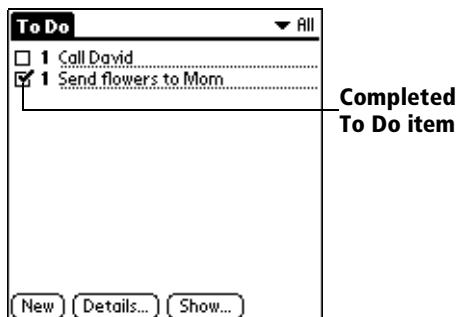

Changing To Do item details

The To Do Item Details dialog box enables you to change settings for individual items.

To display the To Do Item Details dialog box:

1. Tap the text of the item whose details you want to change.
2. Tap Details.



Setting a due date

You can associate a due date with any To Do item. You can also sort the items that appear in the list based on their due date.

To set a due date for a To Do item:

1. In the Details dialog box, tap “No Date” to open the Due Date pick list.

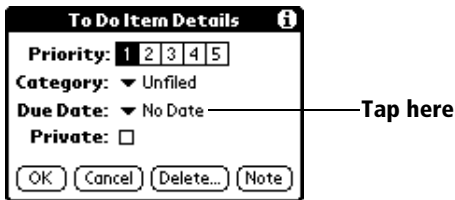

2. Tap the date that you want to assign the item:

Today	Assigns the current date.
Tomorrow	Assigns tomorrow’s date.
One week later	Assigns the date exactly one week from the current date.
No Date	Removes the due date from the item.
Choose date	Opens the date selector, where you can choose any date that you want for the item.

3. Tap OK.

Tip: If you turn on the Show Due Dates option in the To Do Show options dialog, you can tap directly on the due date in the To Do list to open the pick list shown in step 2.

To Do Show Options

The Show Options dialog box enables you to control the appearance of the To Do list screen.

To change the Show Options settings:

1. In To Do list screen, tap Show.



2. Select any of the following settings:

Show Completed Items

Displays your completed items in the To Do list screen. If you turn off this setting, your To Do items disappear from the list when you complete (check) them.

Items that no longer appear on the list because you turn off this setting have not been deleted. They are still in the memory of your handheld. Purge completed items to remove them from memory.

Show Only Due Items

Shows only the items that are currently due, past due, or have no due date specified. When this setting is active, items that are not yet due do not appear in the list until their due date.

Record Completion Date

Replaces the due date with the actual date when you complete (check) the item. If you do not assign a due date to an item, the completion date still records when you complete the item.

Show Due Dates Displays the due dates associated with To Do items and displays an exclamation mark next to items that remain incomplete after the due date passes.

Show Priorities Shows the priority setting for each item.

Show Categories Shows the category for each item.

3. Tap OK.

To Do List menus

To Do List menus are shown here for your reference, and To Do List features that are not explained elsewhere in this guide are described here.

See “Using menus” in Chapter 1 for information about choosing menu commands.

Record menu

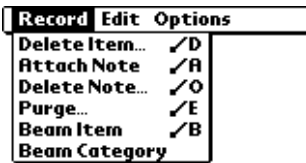

Options menu



About To Do List Shows version information for To Do List.

Memo Pad

A memo can contain up to 4,000 characters. The number of memos you can store is dependent only on the memory available on your handheld. A record in Memo Pad is called a "memo."

To create a new memo:

1. Press the Memo Pad application button  on the front of your handheld to display the Memo list.
2. Tap New.

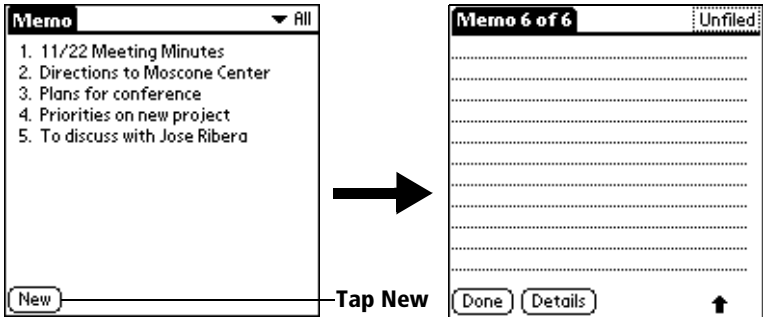

Tip: In the Memo list screen, you can also begin writing in the Graffiti writing area to create a new memo. The first letter is automatically capitalized and begins your new memo.

3. Enter the text you want to appear in the memo. Use the carriage return stroke to move down to new lines in the memo.
4. Tap Done.

Reviewing memos

The first line of a memo appears in the Memo list. This makes it easy to locate and review your memos.

To review a memo:

1. In the Memo list, tap the text of the memo.



Tap a memo to review its contents

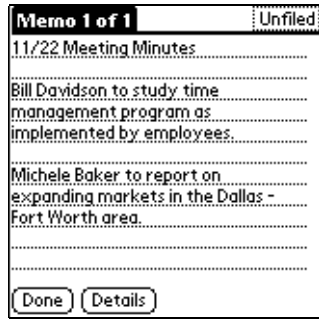

2. Review or edit the text in the memo.
3. Tap Done.

Memo Pad menus

Memo Pad menus are shown here for your reference, and Memo Pad features that are not explained elsewhere in this guide are described here.

See “Using menus” in Chapter 1 for information about choosing menu commands.

The Record and Options menus differ depending on whether you’re displaying the Memo list or an individual memo.

Record menus

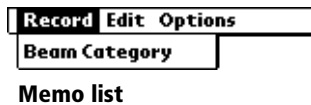

Memo list

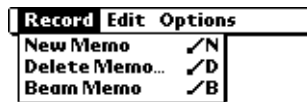

Memo screen

Options menus



Memo list



Memo screen

Preferences

Displays the Memo Preferences dialog box, where you define the sort order for memos.

About Memo Pad

Shows version information for Memo Pad.



Calculator

Calculator includes two operating modes: Basic and Advanced. In Basic mode you can perform simple mathematical calculations. In Advanced mode you can access scientific functions and perform sophisticated math calculations. This section explains how to select the operating mode and use the buttons and menu options available in each mode.

Selecting the Calculator mode

The Change Mode dialog enables you to choose whether you want to work in Basic Calculator mode or Advanced Calculator mode. You can change modes at any time.

To select the Calculator mode:

1. Tap the Calculator icon  next to the Graffiti® writing area.
2. Tap the Menu icon .
3. Tap Options, and then tap Change Mode.
4. Tap Basic or Advanced as the mode.
5. Tap OK.

Using the Basic Calculator buttons

The Basic Calculator includes the following buttons.



Clears the last number you entered. Use this button if you make a mistake while entering a number in the middle of a calculation. This button enables you to re-enter the number without starting the calculation over.



Clears the entire calculation and enables you to begin a fresh calculation.



Toggles the current number between a negative and positive value. If you want to enter a negative number, enter the number first *and then press* the +/- button.



Places the current number in memory. Each new number you enter with the M+ button is *added to the total* already stored in memory. You can add either a calculated value or a number you enter by pressing the number buttons. Pressing this button has no effect on the current calculation (or series of calculations); it merely places the value into memory until it is recalled.



Recalls the stored value from memory and inserts it in the current calculation.



Clears any value that is stored in the Calculator memory.

Displaying Recent Calculations

The Basic Calculator's Recent Calculations command enables you to review the last series of calculations and is particularly useful for confirming a series of "chain" calculations.

To display recent calculations:

1. Tap the Menu icon .
2. Tap Options, and then tap Recent Calculations.

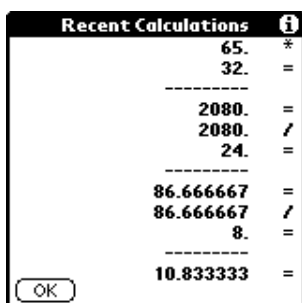

3. After you finish reviewing the calculations, tap OK.

Using the Advanced Calculator mode



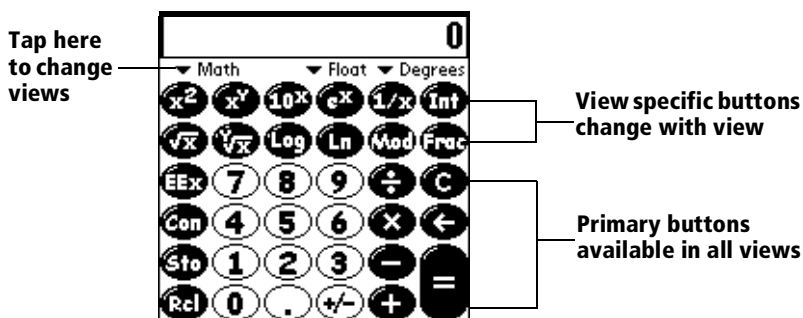



The Advanced Calculator screen consists of three regions. Each region performs a different function to help you perform a variety of calculations.









Using the Advanced Calculator buttons

In addition to most of the Basic Calculator buttons, the Primary buttons are available in all the Advanced Calculator views. The remaining buttons are available only in specific views.

Primary buttons

-  Clears the entire calculation and enables you to begin a fresh calculation.
-  Clears the last digit you entered. Use this button if you make a mistake while entering a number in the middle of a calculation. This button enables you to re-enter the number without starting the calculation over.
-  Enters an exponent symbol in the calculation.
-  Opens the Constants dialog box where you can select a constant to include in the calculation.
-  Opens the Store in which memory dialog box where you can select the memory bank in which you want to store the current value. Advanced Calculator has ten memory banks.
-  Opens the Recall which memory dialog box where you can select the memory bank from which you want to recall a value.

Math buttons

-  Squares the current value.
-  Calculates the value of x raised to the y power.
-  Calculates the value of a common (base 10) antilogarithm.
-  Calculates the value of a natural (base e) antilogarithm.
-  Calculates the reciprocal of the current number.
-  Displays the integer portion of a decimal value.
-  Calculates the square root of the current number.



Calculates the inverse of x to the y power.



Calculates the common (base 10) logarithm.



Calculates the natural (base e) logarithm.



Displays the remainder of x/y .



Displays the decimal portion of a decimal value.

Trigonometry buttons



Calculates the sine of the current number.



Calculates the cosine of the current number.



Calculates the tangent of the current number.



Calculates the hyperbolic sine of the current number.



Calculates the hyperbolic cosine of the current number.



Calculates the hyperbolic tangent of the current number.



Calculates the arc (inverse) sine of the current number.



Calculates the arc (inverse) cosine of the current number.



Calculates the arc (inverse) tangent of the current number.



Calculates the arc (inverse) hyperbolic sine of the current number.



Calculates the arc (inverse) hyperbolic cosine of the current number.



Calculates the arc (inverse) hyperbolic tangent of the current number.

Finance buttons

Finance buttons enable you to find an unknown variable value based on a group of known variable values.

For example, to calculate the monthly payment for a 30-year home loan of \$100,000 with an annual interest rate of 8%, you would enter the following variables:













- $\text{Payments/year} = 12$
- $N = 360$ (30 years \times 12 months)
- $\text{APR} = 8$
- $\text{PV} = 100,000$
- $\text{FV} = 0$

Using these variables, the answer would be -733.76 per month.













To solve this example:

1. Enter a value and then tap the corresponding variable button. Repeat this process until you've entered the following four variables:
 - $N = 360$ (30 years \times 12 months)
 - $\text{APR} = 8$
 - $\text{PV} = 100,000$
 - $\text{FV} = 0$
2. Enter 12 and tap the P/Yr button to enter the number of payments/year.
3. Tap Edit.
4. Tap the Pmt line and erase all values on the line including zero.
5. Tap Solve.
6. Tap Done.





You can use a similar process to solve other financial equations by entering four of the variables to find the value of the fifth variable.

-  Stores the current number as the total number of payments over the life of the loan.
-  Stores the current number as the annual percentage rate of interest.
-  Stores the current number as the number of payments per year.
-  Stores the current number as the initial loan amount.
-  Stores the current number as the payment amount.
-  Stores the current number as the compounded loan amount including interest.
-  Opens the Time Value of Money dialog box where you can modify values and solve the equation.
-  Stores the remaining balance, interest, and principal (amortization) based on the supplied values.
-  Calculates a given percentage of a value. To use this button, enter a value, tap this button, enter the percent, and then tap the equal sign button.
-  Calculates the change in a value by a given percentage. To use this button, enter a value, tap this button, enter the percent, and then tap the equal sign button.
-  Calculates the percentage of one number relative to another number. To use this button, enter the first number, tap this button, enter the second number, and then tap the equal sign button.
-  Calculates the percentage required to get to one value from another value. To use this button, enter the result number, tap this button, enter the starting number, and then tap the equal sign button.

Logic buttons

-  Shifts the value to the left and fills the new places with zeros.
-  Enters D in a hexadecimal calculation.
-  Enters E in a hexadecimal calculation.
-  Enters F in a hexadecimal calculation.
-  Calculates bit-by-bit commonalities between two arguments.
-  Calculates bit-by-bit unique occurrences in two arguments.
-  Shifts the sign bit to the right in signed mode.
-  Enters A in a hexadecimal calculation.
-  Enters B in a hexadecimal calculation.
-  Enters C in a hexadecimal calculation.
-  Calculates the inverse of each bit of the argument.
-  Calculates the exclusive OR between two arguments.

Statistics buttons

-  Adds the current value to the end of the statistics memory list. You can store up to 200 values.
-  Calculates the mean of the values in the statistics memory list.
-  Calculates the standard deviation based on a population of n .
-  Calculates the standard deviation based on a population of $n-1$.
-  Calculates the sum of the values in the statistics memory list.



Calculates the square of the sum of the values in the statistics memory list.



Opens the Statistical Data dialog box where you can view, edit, delete, and clear values in the statistics memory list.



Displays the number of values in the statistics memory list.



Calculates the factorial of any integral from 0 to 170.



Generates a random number between 0 and 32767 and then divides this number by 32768 to generate a random fraction between 0 and .99997.



Returns the number of combinations of n items taken m at a time.



Returns the number of permutations of n items taken m at a time.

Weight/Temp buttons



Indicates the current value is entered in ounces. When you tap this button after tapping another unit of measure, it converts the value to ounces.



Indicates the current value is entered in pounds. When you tap this button after tapping another unit of measure, it converts the value to pounds.



Indicates the current value is entered in tons. When you tap this button after tapping another unit of measure, it converts the value to tons.



Indicates the current value is entered in milligrams. When you tap this button after tapping another unit of measure, it converts the value to milligrams.



Indicates the current value is entered in grams. When you tap this button after tapping another unit of measure, it converts the value to grams.



Indicates the current value is entered in kilograms. When you tap this button after tapping another unit of measure, it converts the value to kilograms.



Indicates the current value is entered in degrees Fahrenheit. When you tap this button after tapping another unit of measure, it converts the value to degrees Fahrenheit.



Indicates the current value is entered in degrees Celsius. When you tap this button after tapping another unit of measure, it converts the value to degrees Celsius.

Length buttons



Indicates the current value is entered in inches. When you tap this button after tapping another unit of measure, it converts the value to inches.



Indicates the current value is entered in feet. When you tap this button after tapping another unit of measure, it converts the value to feet.



Indicates the current value is entered in yards. When you tap this button after tapping another unit of measure, it converts the value to yards.



Indicates the current value is entered in miles. When you tap this button after tapping another unit of measure, it converts the value to miles.



Indicates the current value is entered in nautical miles. When you tap this button after tapping another unit of measure, it converts the value to nautical miles.



Indicates the current value is entered in millimeters. When you tap this button after tapping another unit of measure, it converts the value to millimeters.



Indicates the current value is entered in centimeters. When you tap this button after tapping another unit of measure, it converts the value to centimeters.



Indicates the current value is entered in meters. When you tap this button after tapping another unit of measure, it converts the value to meters.



Indicates the current value is entered in kilometers. When you tap this button after tapping another unit of measure, it converts the value to kilometers.

Area buttons



Indicates the current value is entered in square inches. When you tap this button after tapping another unit of measure, it converts the value to square inches.



Indicates the current value is entered in square feet. When you tap this button after tapping another unit of measure, it converts the value to square feet.



Indicates the current value is entered in square yards. When you tap this button after tapping another unit of measure, it converts the value to square yards.



Indicates the current value is entered in acres. When you tap this button after tapping another unit of measure, it converts the value to acres.



Indicates the current value is entered in square miles. When you tap this button after tapping another unit of measure, it converts the value to square miles.



Indicates the current value is entered in square millimeters. When you tap this button after tapping another unit of measure, it converts the value to square millimeters.



Indicates the current value is entered in square centimeters. When you tap this button after tapping another unit of measure, it converts the value to square centimeters.



Indicates the current value is entered in square meters. When you tap this button after tapping another unit of measure, it converts the value to square meters.















Indicates the current value is entered in hectares. When you tap this button after tapping another unit of measure, it converts the value to hectares.



Indicates the current value is entered in square kilometers. When you tap this button after tapping another unit of measure, it converts the value to square kilometers.



Volume buttons

-  Indicates the current value is entered in teaspoons. When you tap this button after tapping another unit of measure, it converts the value to teaspoons.
-  Indicates the current value is entered in fluid ounces. When you tap this button after tapping another unit of measure, it converts the value to fluid ounces.
-  Indicates the current value is entered in cups. When you tap this button after tapping another unit of measure, it converts the value to cups.
-  Indicates the current value is entered in pints. When you tap this button after tapping another unit of measure, it converts the value to pints.
-  Indicates the current value is entered in quarts. When you tap this button after tapping another unit of measure, it converts the value to quarts.
-  Indicates the current value is entered in gallons. When you tap this button after tapping another unit of measure, it converts the value to gallons.
-  Indicates the current value is entered in tablespoons. When you tap this button after tapping another unit of measure, it converts the value to tablespoons.
-  Indicates the current value is entered in milliliters. When you tap this button after tapping another unit of measure, it converts the value to milliliters.
-  Indicates the current value is entered in liters. When you tap this button after tapping another unit of measure, it converts the value to liters.
-  Indicates the current value is entered in cubic inches. When you tap this button after tapping another unit of measure, it converts the value to cubic inches.
-  Indicates the current value is entered in cubic feet. When you tap this button after tapping another unit of measure, it converts the value to cubic feet.
-  Indicates the current value is entered in cubic meters. When you tap this button after tapping another unit of measure, it converts the value to cubic meters.

Creating a custom view

You can modify any existing Advanced Calculator view to create your own view. While customizing a view, you can change the button names as well as the button definitions.

To create a custom view:

1. From the Advanced Calculator screen, tap the Menu icon .
2. Tap Program, and then tap Export.
3. Tap the pick list and select the view you want to modify.
4. Tap Export and then tap OK.
5. Tap Done.
6. In Memo Pad, open the memo containing the definition you selected in step 3.
7. Modify the definition, and then tap Done.
8. From the Advanced Calculator screen, tap the Menu icon .
9. Tap Program, and then tap Import.
10. Tap the pick list and select the view you modified.
11. Tap Import.
12. Tap Replace to change an existing definition, or tap Add to create an additional definition.
13. Tap OK, and then tap Done.

Calculator menus

Calculator menus are shown here for your reference, and Calculator features that are not explained elsewhere in this guide are described here. See “Using menus” in Chapter 1 for information about choosing menu commands.

Options menus

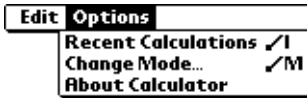

Basic Calculator



Advanced Calculator

About Calculator Shows version information for Calculator.

Program menu



Advanced Calculator

Export Opens the Export dialog box where you can select a view definition to export to Memo Pad.

Import Opens the Import dialog box where you can select a view definition to import to Memo Pad.

Delete View Opens the Delete View dialog box where you can delete a user-defined view.

Restore Defaults Returns all the view definitions to the preset default values.



CityTime

CityTime enables you to display the day and time in your home city and in four other cities around the globe. Whether you're travelling or at home, now it's easy to keep track of the best time to reach your business associates, friends, and family in far away places.

Setting your home city

The home city serves as a point of reference for your other city selections. The information displayed for all the other cities is based on the day and time in your home city. When you use CityTime for the first time (or when your travel or move to another city), make sure you set your home city location. Setting your home city location ensures that CityTime displays accurate information for the other cities you select.

To set your home city:

1. Tap the Applications icon .
2. Tap the CityTime icon .
3. Tap the Menu icon .
4. Tap Options, and then tap Select Home City.
5. Tap the Home City pick list and select the city closest to where you are located.

Tip: If a nearby city isn't in the list, you can use the Edit Cities command to add a new city to the list. See "Adding cities" later in this section for details.

6. Tap OK.

Selecting remote cities

In addition to your home city, you can display the day and time for four other cities anywhere around the globe. These other cities are called remote cities.

To set your remote cities:

1. Tap a pick list in the lower part of the CityTime screen and select the city closest to the city you want to display.



**Tap to select
a remote city**

Tip: If a nearby city isn't in the list, you can use the Edit Cities command to add a new city to the list. See the next section "Adding cities" for details.

2. Tap the remaining pick lists and select the other three cities you want to display.

Tip: You can temporarily display the day and time for any other city by tapping the city's location on the map display.

Adding cities

If the city you want to display is not in the predefined list, you can use the Edit Cities command to add it.

To add a city to the list:

1. Tap the Menu icon .
2. Tap Options, and then tap Edit Cities.
3. Tap New.
4. Enter the city name and other information.
5. Tap OK.

CityTime menus

CityTime menus are shown here for your reference, and CityTime features that are not explained elsewhere in this guide are described here. See “Using menus” in Chapter 1 for information about choosing menu commands.

Options menu

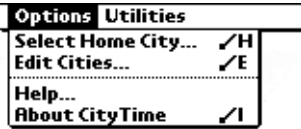

About CityTime Shows version information for CityTime.

Help Displays online help for the CityTime screens.

Utilities menu





Change Location Opens the Change Location dialog box where you can select the city to which you are moving or travelling. Changing the location updates the system time and date.

Sun Rise/Set Opens the Sun Rise/Set dialog box where you can view sunrise and sunset information for your home city. To view this information for another city, tap the City pick list and select the city from the list. To view this information for another date, tap the scroll arrows next to the date box.

Expense

Expense enables you to record the date, expense type, and the amount that you spent. A record in Expense is called an "item." You can sort your Expense items into categories or add other information that you want to associate with the item.

To create an Expense item:

1. Tap the Applications icon .
2. Tap the Expense icon .
3. Tap New.

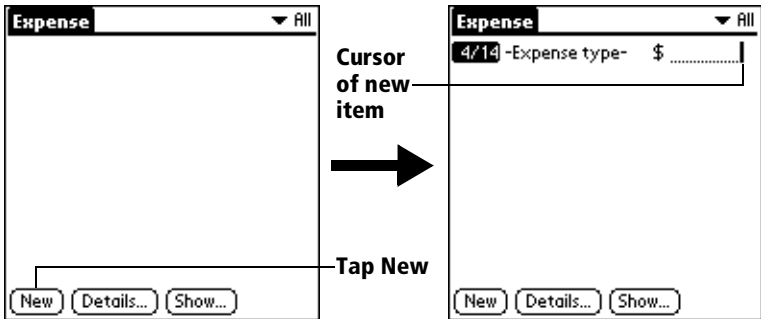

Tip: You can also create a new Expense item by writing on the number side of the Graffiti writing area while in the Expense list screen. The first number you write begins your new Expense item.

4. Enter the amount of the expense.
5. Tap the Expense type pick list and select a type from the list.

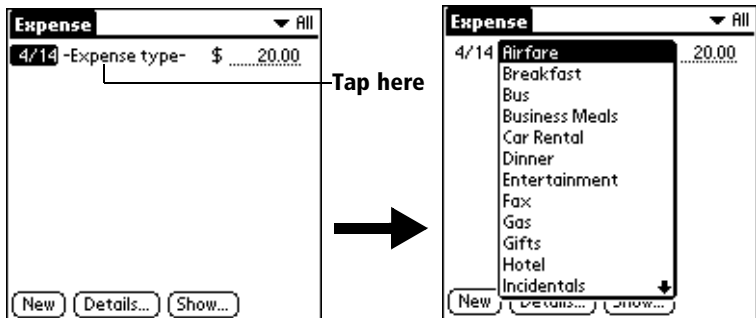

Note: As soon as you select an expense type, your handheld saves the entry. If you don't select an expense type, it doesn't save the entry.

Tip: A quick way to create a new Expense item is to make sure that no Expense item is selected in the Expense list, write the first letter(s) of the expense type, and then write the numerical amount. This technique takes advantage of the automatic fill feature. See “Options menu” later in this chapter for details.

Changing the date of an Expense item

Initially, Expense items appear with the date you enter them. You can use Expense to change the date associated with any Expense item.

To change the date of an Expense item:

1. Tap the Expense item you want to change.
2. Tap the date of the selected item.

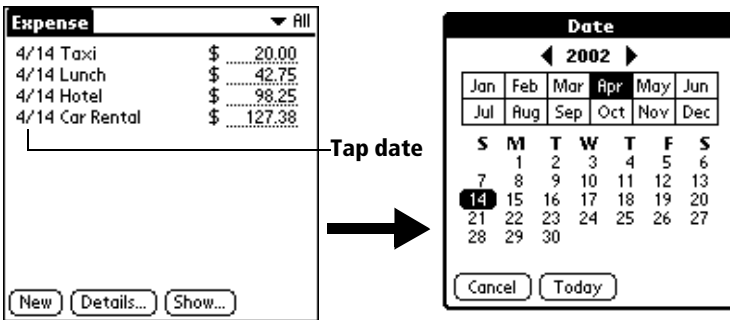

3. Tap the new date.

Entering receipt details

Expense provides a variety of options that you can associate with an item. These options appear in the Receipt Details dialog box.

To open the Receipt Details dialog box:

1. Tap the Expense item to which you want to assign details.
2. Tap Details.

The 'Receipt Details' dialog box contains the following fields and options:

- Category:** ▼ Unfiled
- Type:** ▼ Lunch
- Payment:** ▼ Unfiled
- Currency:** ▼ \$
- Vendor:**
- City:**
- Attendees:** Who...

Buttons at the bottom: OK, Cancel, Delete, Note, and an upward arrow.

3. Select any of the following options:

Category	See “Categorizing records” in Chapter 5.
Type	Opens a pick list of expense types.
Payment	Lets you choose the payment method used to pay the Expense item. If the item is prepaid (such as airline tickets supplied by your company), you can choose Prepaid to place your expense in the appropriate place on your expense report.
Currency	Enables you to choose the type of currency used to pay the Expense item. The default currency unit is defined in the Preferences dialog (see “Options menu” later in this chapter). You can also display up to four other common types of currency. See “Customizing the Currency pick list” later in this chapter for more information.
Vendor and City	Lets you record the name of the vendor (usually a company) associated with the expense and the city where the expense was incurred. For example, a business lunch might be at Rosie's Cafe (Vendor) in San Francisco (City).
Attendees	See “Using Phone Lookup” in Chapter 5.

4. Tap OK.

Customizing the Currency pick list

You can select the currencies and symbols that appear in the Currency pick list.

To customize the Currency pick list:

1. Tap the Currency pick list in the Receipt Details dialog box, and then select Edit currencies.

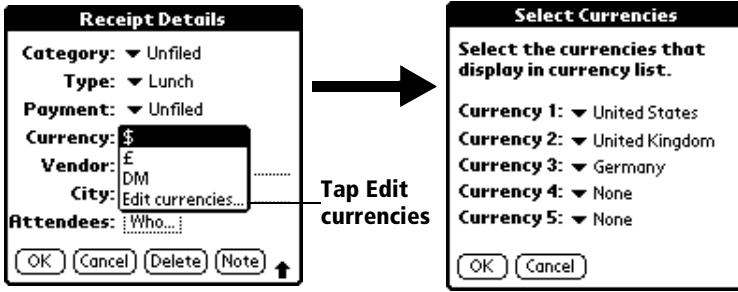

2. Tap each Currency pick list and select the country whose currency you want to display on that line.
3. Tap OK to close the Select Currencies dialog box.
4. Tap OK.

Defining a custom currency symbol

If the currency you want to use is not in the list of countries, you can create your own custom country and currency symbol.

To define a custom currency symbol:

1. Tap the Menu icon .
2. Tap Options, and then tap Custom Currencies.
3. Tap one of the four Country boxes.

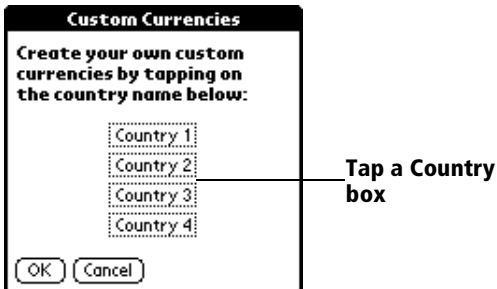

4. Enter the name of the country and symbol to appear in Expense.



5. Tap OK to close the Currency Properties dialog box.
6. Tap OK.

Note: If you want to use your custom currency symbol as the default for all Expense items, select the symbol in the Preferences dialog box. If you want to use your custom currency symbol only for a particular Expense item, select the symbol in the Receipt Details dialog box associated with that item.

Show Options

Show Options define the sort order and other settings that relate to your Expense items.

To open the Show Options dialog box:

1. In the Expense list, tap Show.
2. Select any of the options.

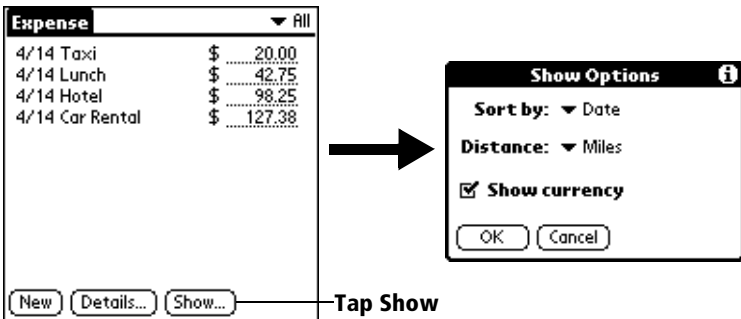

- Sort by** Enables you to sort expense items by date or type.
- Distance** Enables you to display Mileage entries in miles or kilometers.
- Show currency** Shows or hides the currency symbol in the Expense list.

3. Tap OK.

Expense menus

Expense menus are shown here for your reference, and Expense features that are not explained elsewhere in this guide are described here.

See “Using menus” in Chapter 1 for information about choosing menu commands.

Record menu

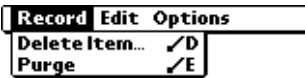

Options menu



Preferences

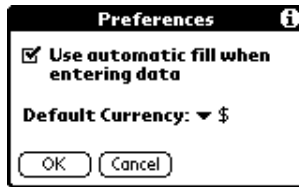

- **Use automatic fill.** Lets you select an expense type by writing the first letter of an expense type in the Graffiti writing area. For example, if you write the letter “T,” it enters the “Taxi” expense type. Writing “T” and then “E” enters “Telephone” which is the first expense type beginning with the letters “TE.”
- **Default currency.** Sets the default currency symbol for Expense.

About Expense Shows version information for Expense.

Chapter 7

Communicating Using Your Handheld

The previous chapter described the features of your Visor handheld computer that help you stay organized. This chapter describes the features that help you stay connected.

- **Managing desktop E-Mail:** Using your handheld, you can read, reply to, compose, and delete e-mail from your desktop E-Mail application while you're away from your desk. (Third-party software required, sold separately.)
- **IR beaming:** The infrared port located on the side of your handheld lets you send data from your handheld — including entire applications — to any other Palm OS® handheld that's close by and has an IR port. You can also use the infrared port to perform HotSync operations. See "IR HotSync operations" in Chapter 8 for details.

Managing desktop E-Mail away from your desk



Mail lets you manage the e-mail that you send and receive through the E-Mail application on your desktop computer. You can read, reply to, compose, and delete e-mail on your handheld. To send or receive e-mail, you must perform a HotSync® operation either locally, using the handheld cradle or infrared port, or remotely, using a modem.

The key to Mail is that it truly synchronizes the mail in the Inbox of your desktop E-Mail application with the mail on your handheld. For example, if you delete e-mail items from Mail, your next HotSync operation also deletes the e-mail items from your desktop E-Mail application, so you never have to delete e-mail items twice. Similarly, if you read an e-mail item on your handheld and leave it in your Inbox, your next HotSync operation marks it as read in your desktop E-Mail application.

In Mail, you can do the following:

- View, delete, file, and reply to incoming mail.
- Create outgoing e-mail items and drafts of e-mail items.
- Create simple or complex filters, which allow you to decide the type of e-mail that your handheld retrieves from your desktop E-mail application.
- Use your handheld in its cradle or infrared communication to send and retrieve e-mail items from your desktop E-Mail application. (Third-party software required, sold separately.)

Setting up Mail on the desktop



Before you use Mail for the first time, make sure your desktop E-Mail application is up and running. You must also set up Palm™ Desktop software for use with your desktop E-Mail application. For information on using Mail with a Macintosh, visit the web site: www.handspring.com.

Synchronizing Mail with your E-Mail application

After you enable and configure Mail, you need to perform a HotSync operation to synchronize Mail with your desktop E-Mail application. For a complete explanation of HotSync technology, see Chapter 8.

Opening the Mail application on your handheld

To open Mail:

1. Tap the Applications icon .
2. Tap the Mail icon .

Viewing e-mail items

The Message list displays a list of your incoming e-mail items, who sent them, and the date they were received. E-mail items you've read have a check next to them. High-priority e-mail items appear in bold.

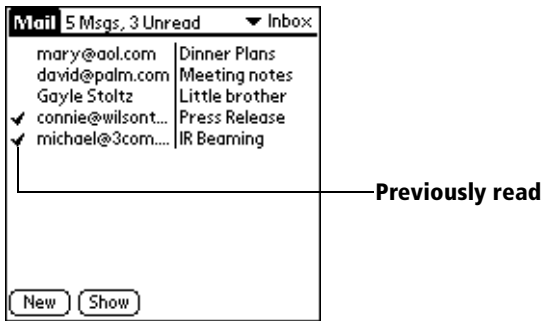

To open an e-mail item:

- Tap an e-mail item to open it.

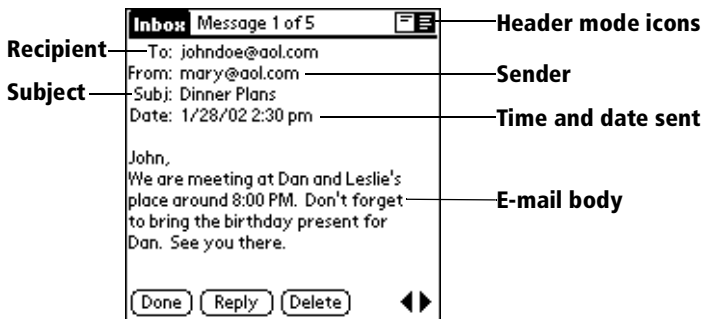

To close an e-mail item:

- Tap Done to close the e-mail item.

Displaying full header information

By default, Mail displays abbreviated header information, which comprises only the From: and Subj: fields. The full header provides complete information about the sender, receiver, and copied recipients, in addition to the subject and date the e-mail item was created. Mail uses the header type you select for all your e-mail items.

To display full header information:

1. Open an e-mail item.
2. Tap the Complete Header icon.

Tip: To redisplay the abbreviated header, tap the Abbreviated Header icon.

Creating e-mail items

You create e-mail items with your handheld the same way you create e-mail with your desktop E-mail application: you identify the recipient(s) of the e-mail item, define a subject, and create the body of the e-mail item.

You create original e-mail items and replies in the New Message screen. All e-mail items must, at the very least, contain information in the To: and Subj: fields.

To create an e-mail item:

1. Tap New.

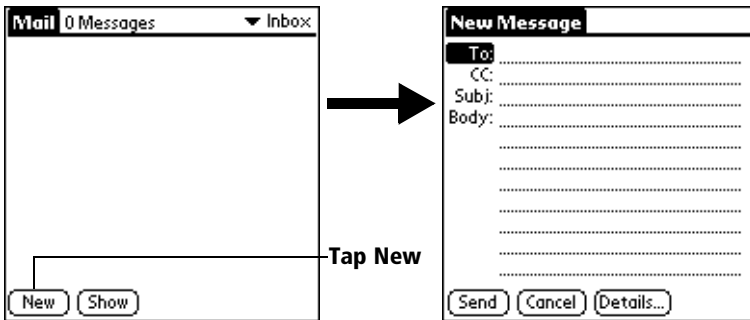

Tip: You can also create an e-mail item by tapping New from the Message menu.

2. Enter the e-mail address of the recipient.

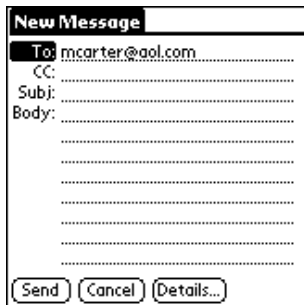

Note: Enter the address as if you were entering it from your desktop E-Mail application. For example, network users sending an e-mail item to a user on the same network do not need to add Internet information, such as @mycorp.com.

- To send a copy of this e-mail item to additional recipients, tap the CC: field, and then enter the e-mail addresses of the additional recipients, separating the addresses with a comma followed by a space.
- Tap the Subj: field and enter a subject for your e-mail item.
- Tap the Body: field and enter the text of your e-mail item.

Tip: If the address, CC, subject, or body exceeds the capacity of the screen display, tap the name of the field (for example, tap "To:") to expand that field. Tap the Done button to return to the New Message screen.

Tap the name of the field to open

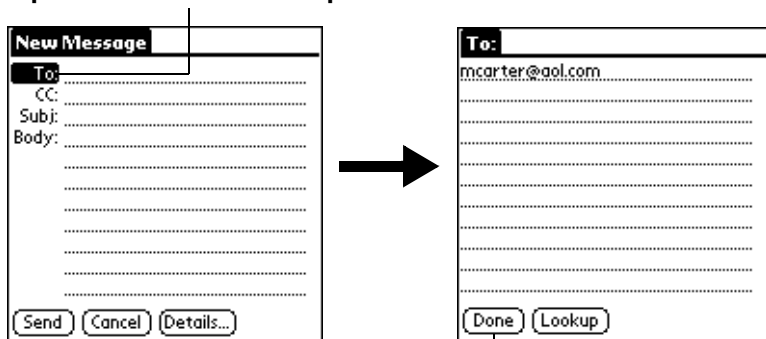

Tap to return to New Message screen

To reply to an e-mail item:

- Tap an e-mail item in the Message list to display it onscreen.
- Tap Reply.
- Select whom you want to receive the reply: Sender only, All recipients, or someone who didn't see the original e-mail item (Forward).



- Select whether you want to include original text or comment original text.
- Tap OK.

6. Enter the text of your reply.

Tip: You have several options including setting the priority. See “Adding details to e-mail items” later in this chapter.

7. Tap Send to place your reply in the Outbox.

Looking up an address

To identify the recipient of an e-mail item, you need to enter that person’s e-mail address. You can do this either by entering the data directly into the field or by using the Look Up command to access the information in your Address list.

To look up an e-mail address:

1. Tap either the To: or CC: field name to expand it.
2. Enter the first few letters of the last name of the person whose address you want to find.
3. Tap Lookup.
4. If the letters you enter identify a unique listing from your Address list, your handheld completes the address for you. If not, the Lookup dialog box appears and lists all records that contain information in an E-mail field.

Tip: You can also open the Look Up dialog box in the New Message screen by tapping Lookup from the Options menu or by using the Graffiti® Command stroke /L.

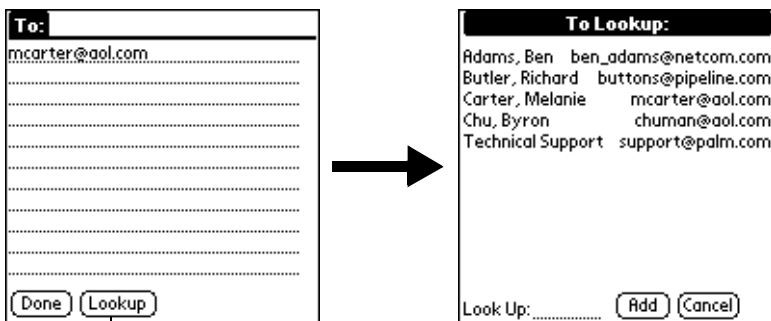

Tap Lookup

5. Enter the first letter of the entry you want to find to scroll to the first entry that begins with that letter. If you write an additional letter, the list scrolls to the first entry that starts with those two letters. For example, writing an “s” scrolls to “Sanders,” and writing “sm” scrolls to “Smith.”

6. Tap an address to select it.
7. Tap Add.

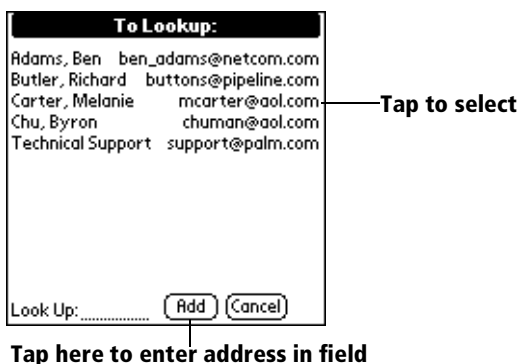

Adding details to e-mail items

Before you send your e-mail item, you can attach additional attributes to it, such as a signature or a priority level. These features are dependent on the desktop E-mail application you use. If your application does not support the attribute you select, your handheld cannot attach that attribute to the e-mail item.

The following details are available:

Priority	Flags an e-mail item as High, Normal, or Low priority.
BCC	Creates a blind carbon copy field in the New Message screen.
Signature	Attaches previously defined text as the closing of an e-mail item. See “Adding a signature to your e-mail item” later in this chapter.
Confirm Read	Requests a confirmation telling you when the e-mail item was read.
Confirm Delivery	Requests a confirmation telling you when the e-mail item was delivered.

Note: The Priority and BCC settings are valid only for the current e-mail item and must be set for each item you create.

Setting a priority

To set a priority for your e-mail item:

1. In the New Message screen, tap Details.

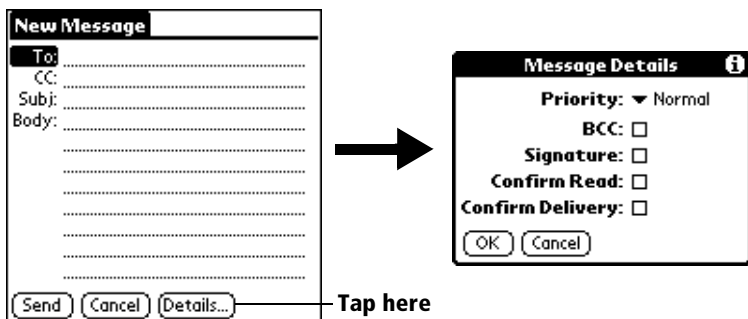

2. Tap the Priority pick list and select the priority you want.

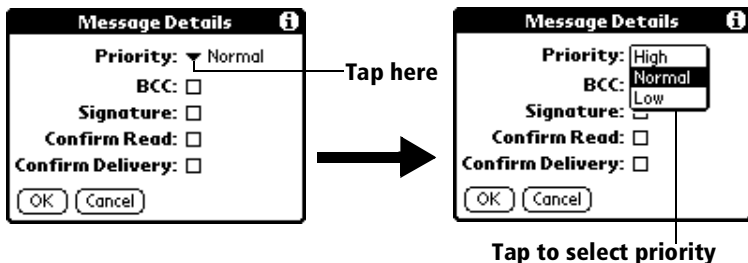

3. Tap OK.

Tip: Your handheld can flag e-mail items with a specific priority only if your desktop E-Mail application supports this feature.

Sending a blind carbon copy

To add a BCC field to your e-mail item:

1. In the New Message screen, tap Details.
2. Tap the BCC check box to select it.
3. Tap OK.

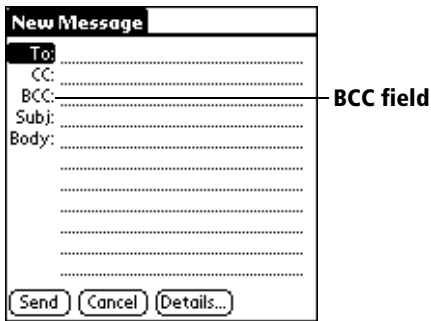

4. Tap the BCC: field and enter an address.

Adding a signature to your e-mail item

A signature consists of information about yourself that is appended to your e-mail item as its closing. For example, a signature can contain your name, address, phone and fax numbers, and any other text you want to include. By defining such information as a signature, you save yourself the trouble of having to enter it every time you create an e-mail item.

Adding a signature to your message is a two-part process. First, you create your signature. Then you select the Signature option.

To create a signature:

1. Tap the Menu icon .
2. Tap Options, and then tap Preferences.
3. Tap the Signature text field and enter the text of your signature.

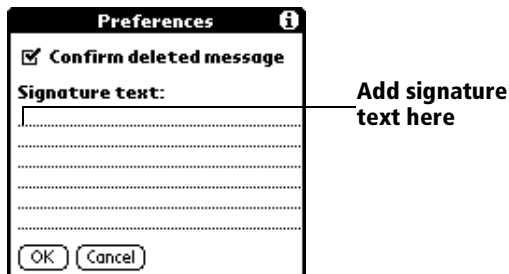

4. Tap OK.

To add a signature to your e-mail item:

1. In the New Message screen, tap Details.
2. Tap the Signature check box to select it and add your signature to the e-mail item.

Note: The check box stays selected, so all subsequent e-mail items you create will also contain your signature until you deselect the Signature option.

3. Tap OK.

Note: The signature does not display in your e-mail item; only your recipient sees the signature.

Requesting confirmations

To receive a confirmation when your e-mail item is read:

1. In the New Message screen, tap Details.
2. Tap the Confirm Read check box to select it.
3. Tap OK.

To receive a confirmation when your e-mail item is delivered:

1. In the New Message screen, tap Details.
2. Select the Confirm Delivery check box to select it.
3. Tap OK.

Storing e-mail to be sent later

When you send e-mail from your handheld, it actually stores the e-mail in the Outbox folder until the next time you synchronize your handheld with your computer. During synchronization, all e-mail stored in the Outbox folder is transferred to the Outbox folder in your desktop E-Mail application. E-mail created on your handheld is sent out the next time you send mail from your desktop E-Mail application.

To send e-mail:

- After you create an e-mail item, tap Send.

Editing unsent e-mail

You can make changes to an e-mail that has not yet been sent, as long as you have not yet performed a HotSync operation. When you edit an e-mail item, your handheld removes the item from the Outbox folder and takes you back to the New Message screen, where you can edit the item and resend it, save it as a draft, or delete it.

To retrieve an e-mail item:

1. In the Message list, tap Outbox from the pick list in the upper-right corner.

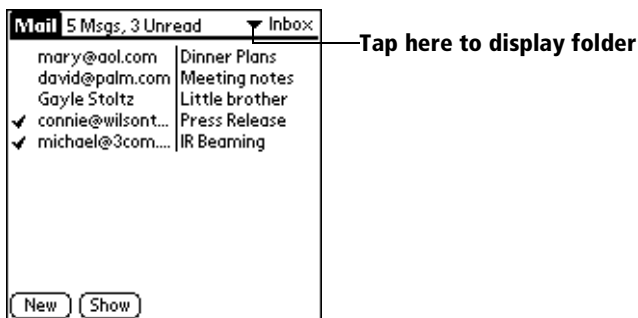

2. Tap the e-mail item you want to retrieve.

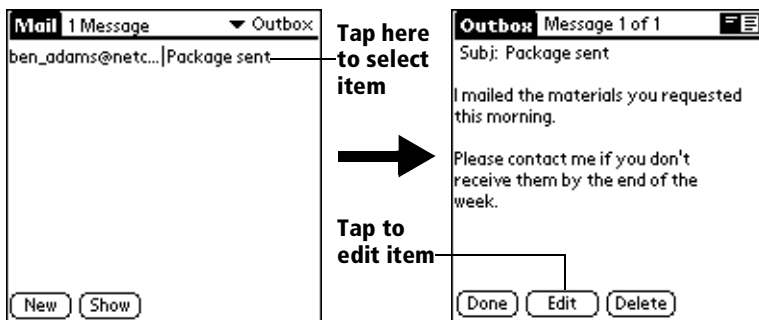

3. Tap Edit.

Draft e-mail

Sometimes you may not want to send an e-mail item immediately; for example, you may want to add additional information before sending it. Your handheld stores such e-mail items in the Draft folder until you are ready to edit them again.

Note: When you're creating or editing an e-mail item, you can also save the item as a draft by canceling it. When you cancel an item, your handheld opens a dialog asking if you want to save the e-mail item. If you tap Yes, your handheld saves the item in the Draft folder.

To save an e-mail item as a draft:

1. Create an e-mail item.
2. Tap the Menu icon .
3. Tap Message, and then tap Save Draft.

To edit an e-mail item saved as a draft:

1. In the Message list, tap Draft from the pick list in the upper-right corner.
2. Tap the draft you want to display.

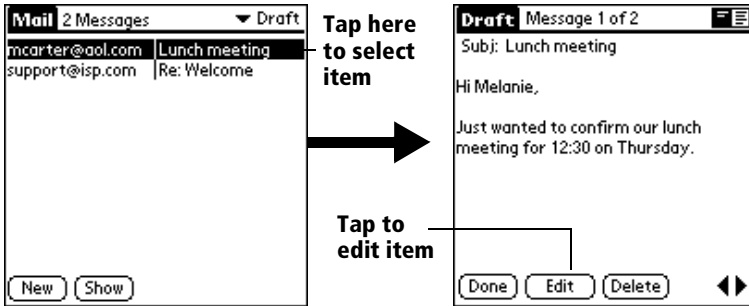

3. Tap Edit.
4. Enter your changes; then either save the e-mail item again as a draft, or tap Send to move the item to your Outbox folder.

Filing e-mail

Your handheld can store e-mail you receive or create in the Filed folder. The contents of this folder do not automatically synchronize with your desktop E-Mail application during a HotSync operation. Your handheld, however, stores a backup copy of the Filed folder on your computer hard disk.

To file e-mail:

1. Open an e-mail item.
2. Tap the Menu icon .
3. Tap Message, and then tap File.
4. Tap No to save the e-mail item and move it to the Filed folder, or tap Yes to file the item and keep a copy in the Inbox.

To remove e-mail from the Filed folder:

1. In the Message list, tap Filed from the pick list in the upper-right corner.
2. Tap the e-mail item you want to restore.
3. Tap Edit to display and modify the item.

Tip: After you display and modify the e-mail item, you can send it, save it as a draft, or return it to the Filed folder.

Deleting e-mail

Your handheld stores deleted e-mail in the Deleted folder until you perform the next HotSync operation. If you delete an e-mail item from the handheld, it is also deleted from your desktop E-Mail application when you perform the next HotSync operation.

To delete e-mail:

1. Open the e-mail item you want to delete.
2. Tap Delete.
3. If you selected the Preferences option to confirm deletion, tap Yes.

Removing e-mail from the Deleted folder

You can reverse the deletion of an e-mail item (by removing it from the Deleted folder) as long as you have not performed a HotSync operation or purged the contents of the Deleted folder.

To remove an e-mail item you received from the Deleted folder:

1. In the Message list, tap Deleted from the pick list in the upper-right corner.
2. Tap the e-mail item you want to restore.
3. Tap Undelete to move the selected item to the Inbox and mark it as read.

To remove an e-mail item you created from the Deleted folder:

1. In the Message list, tap Deleted from the pick list in the upper-right corner.
2. Tap the e-mail item you want to restore.
3. Tap Edit to display and modify the item.

Note: After you display and modify the e-mail item, you can send it or save it as a draft.

Purging deleted e-mail

Because your handheld stores deleted e-mail in the Deleted folder until you perform a HotSync operation, deleted e-mail can monopolize storage space. To avoid or correct this problem, purge the contents of your Deleted folder. E-mail that you purge is still deleted from your desktop E-Mail application when you perform the next HotSync operation.

To purge the contents of the Deleted folder:

1. Tap the Menu icon .
2. Tap Message, and then tap Purge Deleted.
3. Tap Yes.

Note: You cannot restore e-mail items after you purge them.

Message list options

Message list options enable you to manage the way the Message list displays information.

Folders

Your handheld provides folders for categorizing your mail. The Message list displays the e-mail items in the folder you select.

To select a folder:

1. Tap the pick list in the upper-right corner to open the list of folders:

- | | |
|----------------|---|
| Inbox | Contains the e-mail from your desktop E-Mail application Inbox, minus any that you have excluded using filtering options. See “Creating special filters” later in this chapter. |
| Outbox | Contains the e-mail you created and sent on the handheld since the last HotSync operation. |
| Deleted | Contains the e-mail you deleted since the last HotSync operation. |
| Filed | Contains the e-mail you want to store on the handheld. |
| Draft | Contains the e-mail you created using the handheld but are not yet ready to send. |

2. Select the folder you want to display in the Message list screen.

Date column

The Date column is optional in the Message list. By default, the Date column is hidden to increase the available screen space.

To show the Date column:

1. In the Message list, tap Show.

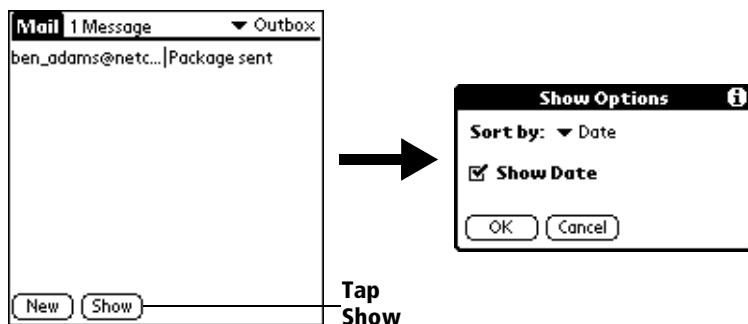

2. Tap the Show Date check box to select it.
3. Tap OK.

Sorting the Message list

You can sort e-mail items by the date sent, by sender, or by subject.

Note: High-priority e-mail items always appear first, no matter how you sort the list.

To sort the Message list:

1. In the Message list, tap Show.
2. Tap the Sort by pick list and select one of the following options:

Date Sorts e-mail by date and displays the most recent e-mail item at the top of the screen.

Sender Sorts e-mail by the sender's user name and displays items in ascending alphabetical order, based on the first word of the From: field.

Subject Sorts e-mail by the subject and displays items in ascending alphabetical order, based on the first word of the Subj: field.

3. Tap OK.

HotSync options

HotSync options enable you to manage your e-mail more effectively by selecting which e-mail items download when you synchronize your computer and your handheld. You can define different settings for local and remote synchronization. For example, you may want to download all of your e-mail during local synchronization and only urgent e-mail during remote synchronization. Once defined, your handheld determines if synchronization is occurring locally or remotely and uses the appropriate settings for the HotSync operation.

Note: The default setting is All. So, if your e-mail Inbox has lots of messages, synchronization could be time consuming.

To open the HotSync Options dialog box:

1. Tap the Menu icon .
2. Tap Options, and then tap HotSync Options.
3. Tap the Settings for pick list and select Local HotSync or Remote HotSync.

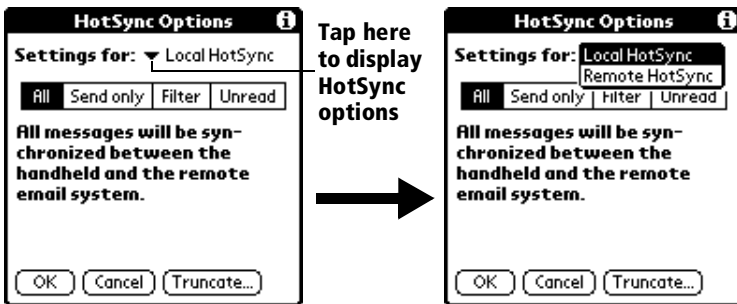

Note: For more information about Local and Remote HotSync operations, see Chapter 8.

4. Tap the filtering option you want to apply:

All During synchronization, all e-mail items in your desktop E-Mail Inbox synchronize with your handheld, and all e-mail items in your handheld Outbox are sent to your desktop E-Mail application.

- Send Only** During synchronization, only the e-mail items in your handheld Outbox are sent to your desktop E-Mail application; from there, they are sent to their destinations.
- Filter** During synchronization, all e-mail items in your handheld Outbox are sent to your desktop E-Mail application, and items in your desktop E-Mail Inbox that meet specific criteria download to your handheld. When you select the Filter setting, the HotSync Options dialog box opens and displays additional filter settings. See “Creating special filters” later in this chapter.
- Unread** During synchronization, only unread e-mail items download to your handheld from your desktop E-Mail Inbox, and all items in your handheld Outbox are sent to your desktop E-Mail application.

Note: The All setting does not mean that all information included in each e-mail item downloads to your handheld. Truncation settings (explained in a following section) for long e-mail items still apply. Also, Mail never downloads any attachments to your handheld. The e-mail item and any text information appear, but the attachment is left in your desktop E-Mail application.

5. If you selected All, Send only, or Unread, tap OK. If you selected Filter, continue to the next section.

Creating special filters

You can create special filters to control the type of e-mail items that download to your handheld during synchronization. Special filters work on the premise of ignoring or retrieving items that contain specific information in their header fields.

To create a special filter, you must decide whether you want to ignore or retrieve certain e-mail items. Then, based on that decision, you must tell your handheld what it needs to look for in the To:, From:, and Subj: fields to single out those e-mail items.

To access the special filter settings:

- Tap the Filter box in the HotSync Options dialog box.

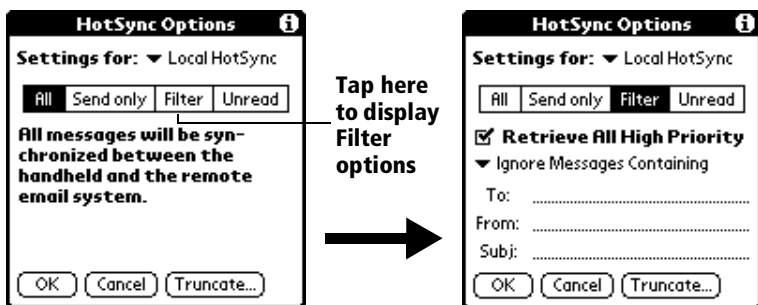

Ignoring or receiving e-mail

The first step in establishing a special filter is to determine whether you want to ignore or retrieve e-mail that matches the information you specify.

To define whether to ignore or receive e-mail:

- Tap the pick list in the center of the HotSync Options dialog box and select one of the following settings:

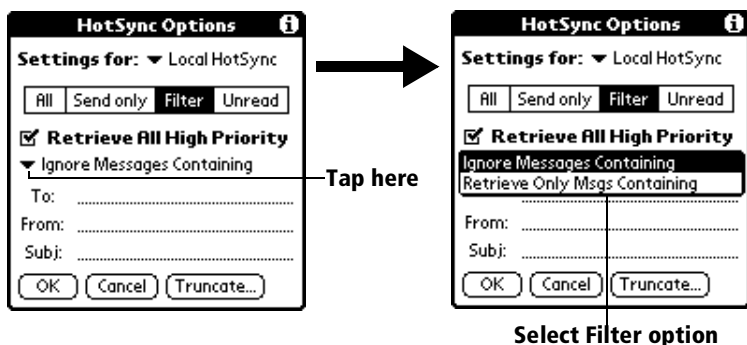

Ignore Messages Containing

Tells your handheld to *exclude* the e-mail items that meet the criteria you define and download *all other e-mail items* during synchronization. In general, this filter downloads more e-mail during synchronization because it blocks only one defined subset of e-mail.

**Retrieve
Only Msgs
Containing**

Tells your handheld to *include* only the e-mail items that meet the criteria you define and to ignore all other e-mail items during synchronization. This filter has the potential to block more e-mail during synchronization because it downloads only one subset of e-mail.

Defining filter strings

E-mail items are filtered based on the information contained in their To:, From:, and Subj: fields. The information that defines what your handheld is looking for is called a *filter string*. You create a filter string by listing the words you want your handheld to find and separating them with either a comma or a space. Each word in the filter string is joined by an implicit OR, so you do not need to enter logical connectors like AND or OR.

To create a more complex filter, you can define filter strings for the To:, From:, and Subj: fields simultaneously. Your handheld joins the filter strings for these fields using an implicit AND; once again, you do not need to add the logical connector. Your handheld does that for you.

For example, suppose you want to receive only e-mail items from John Smith (jsmith@aol.com) or Jack Jones (jjones@aol.com) concerning the Apollo Project. You would create the following filter strings:

In the To: field: jsmith@aol.com, jjones@aol.com

In the Subj: field: Apollo Project

Your handheld interprets this as, "Accept e-mail items about the Apollo Project from John Smith or Jack Jones. Do not accept e-mail items from other people. Do not accept e-mail items from John or Jack about any other subject."

When you define a string, note that your handheld searches for any instance of that *sequence* of characters. For example, if you create a filter that retrieves only e-mail items containing the string "info," your handheld considers "**info**," "**rainforest**" and "**kinfolk**" appropriate matches.

To define a filter string:

1. Tap a header field in the HotSync Options dialog box.

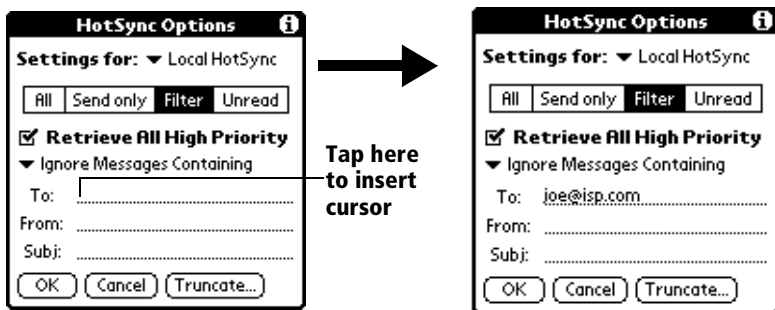

2. Enter your filter string, using commas or spaces to separate the words. Do not add connectors, such as AND or OR, between words in a string.
3. If your string exceeds the length of the field, tap the name of the field to display the Notes screen for that header field. For more information about header field Notes screens, see "Creating e-mail items" earlier in this chapter.

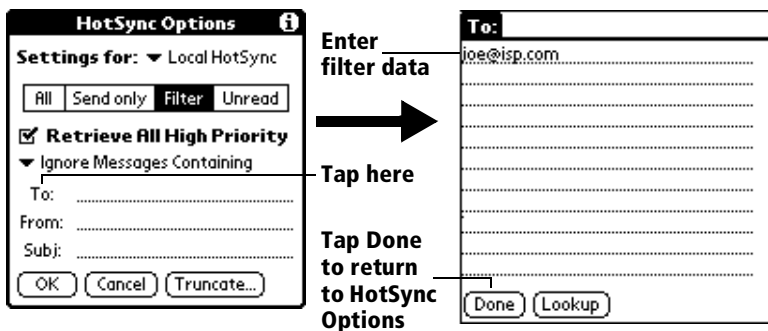

4. Tap Done to return to the HotSync Options dialog box.
5. Tap OK.

High-priority e-mail

The Retrieve All High Priority setting lets you retrieve e-mail items marked high-priority, even if those items would have been blocked by a defined filter.

To retrieve high-priority e-mail items:

1. Tap the Filter box in the HotSync Options dialog box.

2. Tap the Retrieve All High Priority check box to select it.

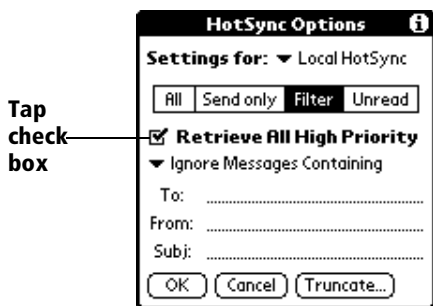

3. Tap OK.

Note: This setting is applicable only if your E-Mail application has the capacity to flag high-priority e-mail items.

Truncating e-mail items

The Truncate feature lets you set a point at which long e-mail items truncate when downloading to your handheld. By default, this Truncate value is 4,000 characters. By truncating long messages, you reduce the time it takes to synchronize your desktop E-Mail and Mail, as well as the amount of storage space e-mail uses on your handheld.

Note: Truncation is separate and independent from filtering.

To truncate e-mail items:

1. Tap Truncate in the HotSync Options dialog box.

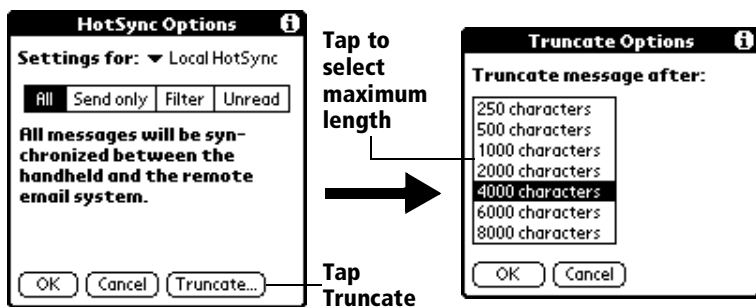

2. Tap to select the truncation setting you want.

Tip: If you select the maximum setting, messages can be 8,000 characters; longer messages are truncated. If you select a lower value, you'll have more room for e-mail items.

3. Tap OK.

Mail menus

Mail menus are shown here for your reference, and Mail features that are not explained elsewhere in this guide are described here.

See "Using menus" in Chapter 1 for information about choosing menu commands.

Message menus

The Message menu varies depending on whether you are viewing an e-mail item, creating an e-mail item, or viewing the Message list.

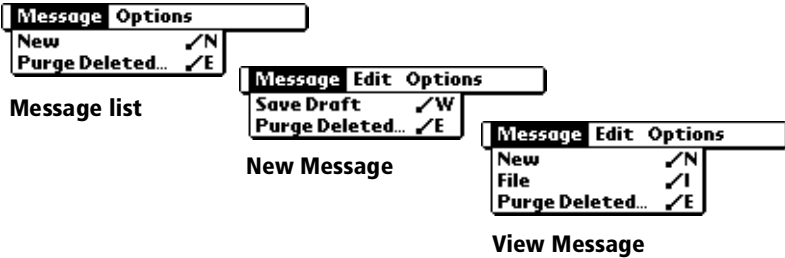

Options menus

The Options menu varies depending on whether you are creating or editing an e-mail item.



About Mail

Shows version information for Mail.

Beaming information

Your Visor handheld is equipped with an IR (infrared) port that you can use to beam information to another Palm OS handheld that's close by and also has an IR port. The IR port is located on the side of the handheld, behind the small dark shield.

You can beam the following information between Palm OS handhelds:

- The record currently displayed in Date Book, Address, To Do List, or Memo Pad

Note: You cannot beam records from Date Book Plus.

- All records of the category currently displayed in Address, To Do List, or Memo Pad
- A special Address record that you designate as your personal business card, containing information you want to exchange with business contacts
- An application installed in RAM memory

To select a business card:

1. Create an Address record that contains the information you want on your personal business card.
2. Tap the Menu icon .
3. Tap Record, and then tap Select Business Card.
4. Tap Yes.

To beam a record, business card, or category of records:

1. Locate the record, business card, or category you want to beam.
2. Tap the Menu icon .
3. Tap Record, and then tap one of the following:
 - The Beam command for an individual record
 - In Address only: Beam Business Card
 - Beam Category
4. When the Beam Status dialog box appears, point the IR port directly at the IR port of the receiving handheld.

Tip: For best results, Visor handhelds should be between 10 centimeters (approximately 4 inches) and 1 meter (approximately 39 inches) apart, and the path between the two devices must be clear of obstacles. Beaming distance to other Palm OS handheld may be different.

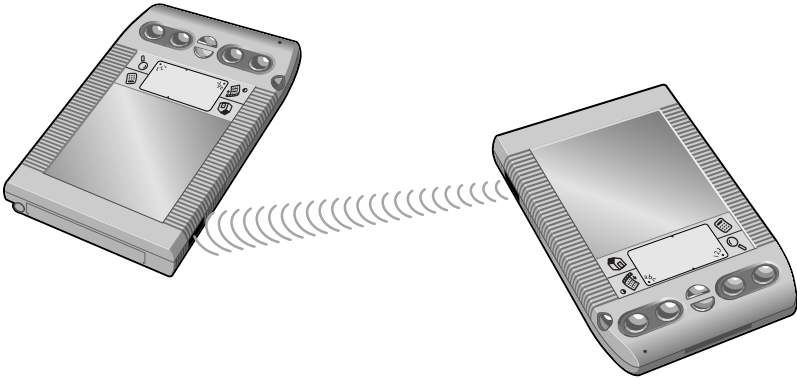

5. Wait for the Beam Status dialog box to indicate that the transfer is complete before you continue working on your handheld.

To beam an application:

1. Open the Applications Launcher.
2. Tap the Menu icon .
3. Tap App, and then tap Beam.
4. Tap the application you want to transfer.

Note: Some applications are copy-protected and cannot be beamed. These are listed with a lock icon next to them.

5. Tap Beam.
6. When the Beam Status dialog box appears, point the IR port directly at the IR port of the receiving handheld.
7. Wait for the Beam Status dialog box to indicate that the transfer is complete before you continue working on your handheld.

To receive beamed information:

1. Turn on your handheld.
2. Point the IR port directly at the IR port of the transmitting handheld to open the Beam Status dialog box.
3. When the Beam dialog box appears, select a category for the entry.

Tip: If you do not select a category the entry is placed in the Unfiled category.

4. Tap Yes.

Tips on beaming information

- You can press the Address application button  for about two seconds to beam your business card.
- You can set the full-screen pen stroke to beam the current entry. See “Pen preferences” in Chapter 9 for more information.
- You can use the Graffiti Command stroke /B to beam the current entry.

Chapter 8

Advanced HotSync® Operations

HotSync® technology enables you to synchronize data between one or more Palm OS® handhelds and Palm™ Desktop software. To synchronize data, you must connect your Visor handheld and Palm Desktop software either directly, by placing your handheld in the cradle attached to your computer or using infrared communication, or indirectly, with a modem.

This chapter describes how to select HotSync options and perform a HotSync operation via the infrared port or a modem. See “Exchanging and updating data: HotSync operations” in Chapter 5 for information about performing your first and subsequent local HotSync operations.

Selecting HotSync setup options

You can choose when you want HotSync Manager to run. If necessary, you can adjust the local and modem HotSync settings as well.

To set the HotSync options:

1. Open Palm Desktop software.
2. From the HotSync menu, choose Setup.

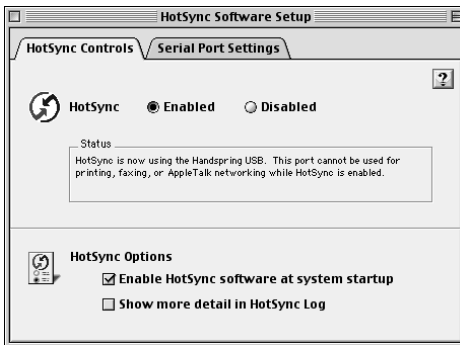

3. Click the HotSync Controls tab and adjust the following options:

Enabled

Prepares your computer to synchronize with your handheld. Serial Port Monitor controls the serial port you specified, prevents you from using the port for other operations, such as printing, faxing or AppleTalk networking.

Disabled

Turns off the Serial Port Monitor and makes the serial port available for use by other applications.

Enable HotSync software at system startup

Starts Serial Port Monitor automatically when you start your computer. You must restart your computer before this option takes affect.

If this option is not checked, you must enable Serial Port Monitor manually in this dialog box.

Show more detail in HotSync Log

Provides troubleshooting information in the log when you perform a HotSync operation. If you are having trouble synchronizing your handheld with your computer, choose this option.

Tip: If you're not sure which options to use, keep the default settings: Enabled and Enable HotSync software at system startup.

4. Click the Serial Port Settings tab to display the settings for the connection between your computer and the handheld cradle, and adjust the following options as needed.

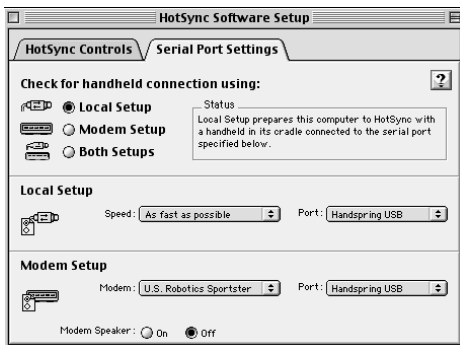

Check for a connection using

Determines the method used to synchronize your handheld and your desktop applications:

- **Local Setup.** Synchronizes while your handheld is in the cradle connected to your computer. Indicate which serial port the cradle is connected to and the speed of the data transfer in the Local Setup options in this dialog box.
- **Modem Setup.** Synchronizes while the handheld communicates to your computer across a telephone line. Indicate which modem this computer uses and which serial port the modem is connected to in the Modem Setup options in this dialog box.
- **Both Setups.** Synchronizes using the cradle or the modem. Indicate the connection details in both Local Setup and Modem Setup options in this dialog box.

Note: Choosing Both Setups prevents you from using either port for other operations such as printing, faxing, or AppleTalk networking.

Local Setup

Specifies how the cradle connects to your computer:

- **Speed.** Determines the speed at which data transfers between your handheld and Palm Desktop software. Try the As Fast As Possible rate first, and adjust downward if you experience problems. This setting allows Palm Desktop software and your handheld to find and use the fastest speed.
- **Port.** Identifies the modem or printer port where you connected the handheld cradle. To connect using the USB cradle, select Handspring USB port.

Modem Setup

Specifies how your handheld communicates with your computer modem. See “Conducting a HotSync operation via modem” later in this chapter for more information.

5. Close the HotSync Software Setup dialog box.

Customizing HotSync application settings

For each application, you can define a set of options that determines how records are handled during synchronization. These options are called a “conduit.” By default, a HotSync operation synchronizes all files between the handheld and Palm Desktop software.

In general, you should leave the settings to synchronize all files. The only reason you might want to change these settings is to overwrite data on either your handheld or Palm Desktop software, or to avoid synchronizing a particular type of file because you don’t use it.

In addition to the conduits for Date Book, Address, To Do List, and Memo Pad, Palm Desktop software includes System and Install conduits. The System conduit backs up the system information stored on your handheld, including Graffiti® ShortCuts. The Install conduit installs applications on your handheld.

To customize HotSync application settings:

1. Open Palm Desktop software.
2. From the HotSync menu, choose Conduit Settings.

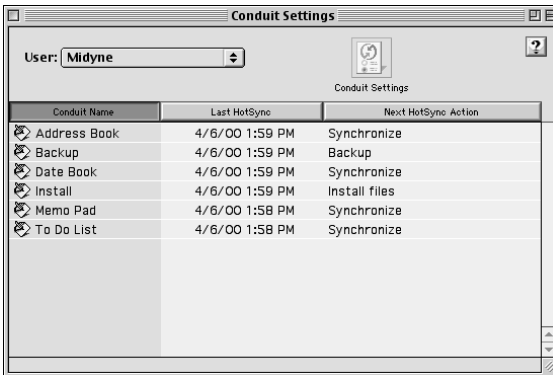

3. From the User pop-up menu, select your user name.
4. Select an application in the Conduit list.
5. Click Conduit Settings.

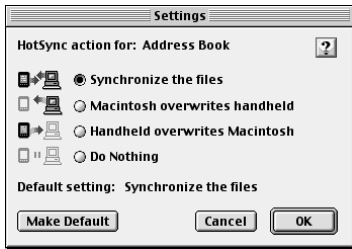

6. Click the direction in which you want to write data, or click Do Nothing to skip data transfer for an application.

Note: Changing the HotSync setting from the default affects only the *next* HotSync operation. Thereafter, the HotSync Actions revert to their default settings. To use a new setting on an ongoing basis, click Make Default. Thereafter, whatever you selected as the default setting is used when you perform a HotSync operation.

7. Click OK.
8. Repeat steps 4 through 7 to change conduit settings for other applications.
9. Close the Conduit Settings dialog box.

IR HotSync operations

Your handheld is equipped with an infrared (IR) port that supports the IrCOMM implementation of the standards for infrared communication established by the Infrared Data Association (IrDA). This means that you can beam data to any other device that supports the IrCOMM implementation of the IrDA standards. Most importantly, you can use the IR port to perform HotSync operations. When you use the IR port on your handheld to perform HotSync operations, you don't need your cradle. You simply enable infrared communication on your computer and your handheld and then perform an IR HotSync operation. So there's no need to carry your cradle when you're on the road with an infrared-enabled laptop.

Preparing your computer for infrared communication

To perform an IR HotSync operation, the computer you want to synchronize with must have an enabled infrared port or be connected to an infrared device that supports the IrCOMM implementation of the IrDA standards.

Desktop computers are likely to require an infrared device attached to a physical COM port. Laptops are likely to have a built-in IR port. Your computer must also have an installed infrared driver.

Does your computer supports infrared communication?

Check the documentation that came with your computer to see if it supports infrared communication.

Configuring HotSync Manager for infrared communication

Next you need to go to the HotSync Manager and specify the port used for infrared communication.

To configure HotSync Manager for infrared communication:

1. Open Palm Desktop software.
2. From the HotSync menu, choose Setup.
3. In the HotSync Controls tab, select Enabled.
4. Click the Serial Port Settings tab.
5. Under Check for handheld connection using, select Local Setup.
6. Under Local Setup, select Infrared Port from the Port pop-up menu.

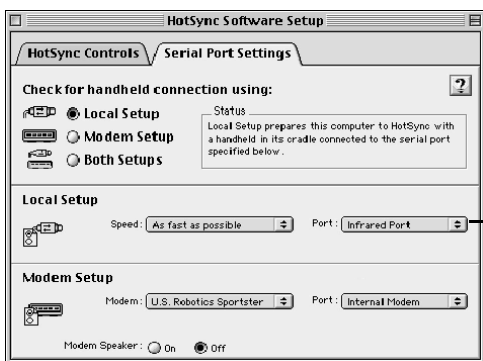

Select
Infrared
Port

7. Close the HotSync Software Setup dialog box.



The HotSync Manager is now communicating with the port defined for infrared communication.

Note: You cannot use your cradle again until you reconfigure the HotSync Manager to communicate with the port defined for cradle synchronization.

Performing an IR HotSync operation

After you complete the steps to prepare for an IR HotSync operation it is easy to perform the actual operation.

To perform an IR HotSync operation:

1. Tap the Applications icon .
2. Tap the HotSync icon .
3. Tap Local.
4. Tap the pick list below the HotSync icon and select IR to a PC/Handheld.

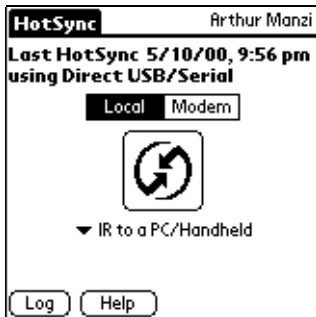

5. Position your handheld's IR port within a couple of inches of your computer's infrared port.
6. Tap the HotSync icon to start the IR HotSync operation.

Returning to cradle HotSync operations

It's easy to return to using the cradle for HotSync operations.

To return to cradle HotSync operations:

1. If needed, connect the cradle to your computer.
2. Open Palm Desktop software.
3. From the HotSync menu, choose Setup.
4. In the HotSync Controls tab, select Enabled.
5. Click the Serial Port Settings tab.
6. Under Check for handheld connection using, select Local Setup.
7. Under Local Setup, select the port where your cradle is connected from the Port pop-up menu.
8. Close the HotSync Software Setup dialog box.

The next time you want to perform a HotSync operation just press the HotSync button on the cradle. You can leave the HotSync application on your handheld set to perform IR HotSync operations and still use the cradle. This is useful if you perform HotSync operations with both your desktop computer and a laptop. When you are in the office just place your handheld in the cradle and press the HotSync button. When you travel, you don't have to carry a cradle or cable.

Conducting a HotSync operation via modem

You can use a modem, such as the Springboard™ modem accessory, to synchronize your handheld when you are away from your computer.

Note: The first HotSync operation must be local, using the cradle. After that, you can perform a modem HotSync operation.

To perform a HotSync operation via modem you must complete the following steps:

- Connect a modem to your computer
- Configure the Palm Desktop software for use with your modem
- Connect a modem to your handheld
- Configure the Modem Preferences on your handheld for use with your modem

Preparing your computer

There are a few steps you must perform to prepare your computer for a modem HotSync operation. Be sure to perform these steps before you leave your office so that your computer is ready to receive a call from your handheld.

To prepare your computer for a modem HotSync operation:

1. Confirm that the computer modem is connected and turned on, and that no communications applications, such as fax or telephony software, are running on a COM port.

Note: Make sure the computer is disconnected from all online services, such as America Online (AOL) and CompuServe. This helps to avoid port conflicts.

2. Open Palm Desktop software.
3. From the HotSync menu, choose Setup.
4. On the HotSync Controls tab, make sure that HotSync is Enabled.

5. Click the Serial Port Settings tab.
6. Under Check for handheld connection using, select Modem Setup.
7. Under Modem Setup, adjust the following options as needed:

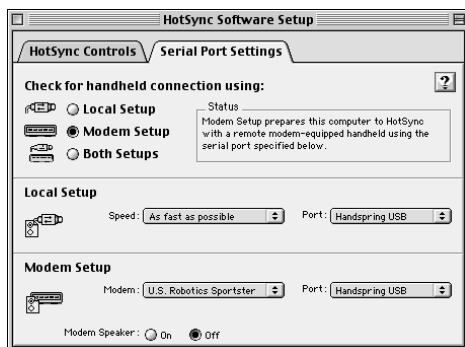

Modem

Identifies the modem type or manufacturer. Refer to your modem manual or face plate for its type or settings. If you're not sure of your modem type or your modem doesn't match any that appear in the list, select Hayes Basic. If you chose Custom from the Modem pop-up menu, a Custom field appears. Use this field to enter a custom modem setup string.

Port

Identifies the port for your computer modem.

Speaker



Turns the computer modem speaker on or off. If you're having trouble connecting, turn on the modem speaker to make sure that it is responding to incoming calls.

8. Close the HotSync Software Setup dialog box.

Preparing your handheld

There are a few steps you must perform to prepare your handheld for a modem HotSync operation.

To prepare your handheld for a modem HotSync operation:

1. Tap the Applications icon .
2. Tap the HotSync icon .
3. Tap Modem.

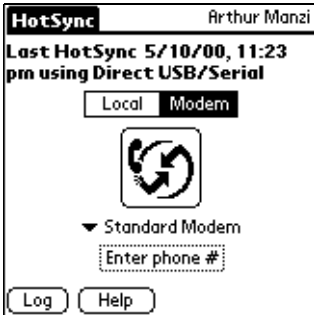

4. Tap the pick list below the HotSync icon and select Standard Modem.
5. Tap the Enter Phone # field.

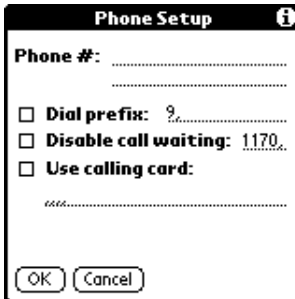

6. Enter the telephone number to access the modem connected to your computer.
7. If needed, enter a dial prefix (such as "9") to access an outside line, and then tap the Dial Prefix check box.



Tip: You can enter a comma in the field to introduce a "pause" in the dialing sequence. Each comma equals a two second pause.

8. If the phone line you're using for the handheld has Call Waiting, select the Disable call waiting check box to avoid an interruption during the modem HotSync operation.
9. If you want to use a calling card to place the call, select the check box and enter the calling card number.
10. Tap OK.
11. Tap the Menu icon .
12. Tap Options, and then tap Modem Setup.
13. Enter the settings. See "Network preferences and TCP/IP software" in Chapter 9 for more information.

Selecting the conduits for a modem HotSync operation

The Conduit Setup dialog box on your handheld enables you to define which files and/or applications synchronize during a modem HotSync operation. You can use these settings to minimize the time required to synchronize data with a Springboard modem accessory.

To change the Conduit Setup for a modem HotSync operation:

1. Tap the Applications icon .
2. Tap the HotSync icon .
3. Tap the Menu icon .
4. Tap Options, and then tap Conduit Setup.
5. Tap the check boxes to deselect the files and applications that you do *not* want to synchronize during a modem HotSync operation. The default setting is to synchronize all files.





Note: Applications that do not have a database (such as games) do not synchronize — even if you select the item in the Conduit Setup dialog box.

6. Tap OK.

Performing a HotSync operation via a modem

After you prepare your computer and your handheld, and select your Conduit Setup options, you are ready to perform a modem HotSync operation.

To perform a modem HotSync operation:

1. Tap the Applications icon .
2. Tap the HotSync icon .
3. Tap the Modem icon  to dial the Palm Desktop modem and synchronize the applications.
4. Wait for the HotSync operation to finish. If you have any problems conducting a successful HotSync operation, see Appendix B.

Creating a user profile

If you need to configure several Palm OS® handhelds with specific information (such as a company phone list) before distributing them to their actual users, you can create a user profile to load the data into a handheld without associating that data with a user name. The User Profile feature is designed only for the first-time HotSync operation, before you assign a User ID to a particular handheld.

To create a user profile:

1. Open Palm Desktop software.
2. From the User pop-up menu, choose Edit Users.

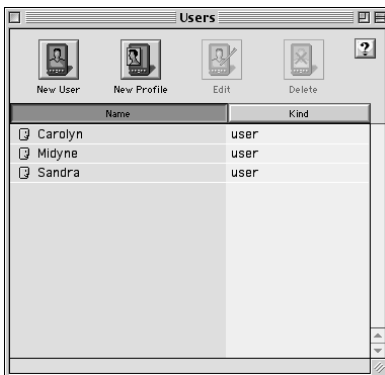

3. Click New Profile.



4. Enter the name of the profile and click OK.
5. Close the Users dialog box.
6. From the User pop-up menu, choose the profile name and create the data for the profile (e.g., company phone list, etc.).

To use a profile for the first-time HotSync operation:

1. Place the new handheld in the cradle.
2. Press the HotSync button on the cradle.
3. Select the profile that you want to load on the handheld, and click OK.

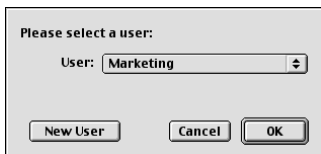

4. Click Yes to transfer all the profile data to the handheld.

The next time you perform a HotSync operation, Palm Desktop software prompts you to assign a user name to the handheld.

Chapter 9

Setting Preferences for Your Handheld



The Preferences screens enable you to customize the configuration options on your Visor handheld.

In the Preferences screens, you can do the following:

Buttons	Assign different applications to the buttons on the front panel of your handheld and the HotSync® button on the cradle, and reassign the full-screen pen stroke command.
Connection	Configure your handheld for use with a modem, such as the Springboard™ modem accessory, with infrared communication, or a cradle.
Digitizer	Calibrate the screen on your handheld.
Formats	Set the country default and the formats for dates, times, calendar, and numbers.
General	Set the current date and time, the auto shut-off interval, the Beam Receive feature, and the system, alarm, and game sounds.
Network	Configure your handheld for use with a network.
Owner	Assign your name, phone number, and other owner information to your handheld.
ShortCuts	Define a list of Graffiti® abbreviations.

Viewing preferences

To open the Preferences screens:

1. Tap the Applications icon .
2. Tap the Preferences icon .
3. Tap the pick list in the upper-right corner of the screen.
4. Select the Preferences screen you want to view.

Buttons preferences

The Buttons Preferences screen enables you to associate different applications with the buttons on the front of the handheld.

For example, if you find that you seldom use To Do List and often use Expense, you can assign the To Do List button to start Expense.

Any changes you make in the Buttons Preferences screen become effective immediately; you do not have to change to a different screen or application.

If you assign a different application to a button, you can still access the original application using the Applications Launcher.

To change the Buttons preferences:

1. Tap the pick list next to the button you want to re-assign.

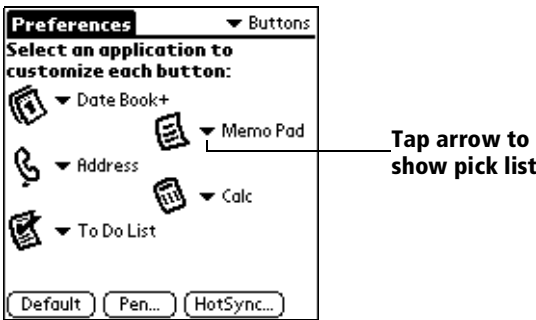

2. Tap the application that you want to assign to the button.

Tip: To restore all of the buttons to their factory settings, tap Default.

Pen preferences

The Buttons Preferences screen enables you to change the assignment of the full-screen pen stroke. By default, the full-screen pen stroke activates Graffiti Help.

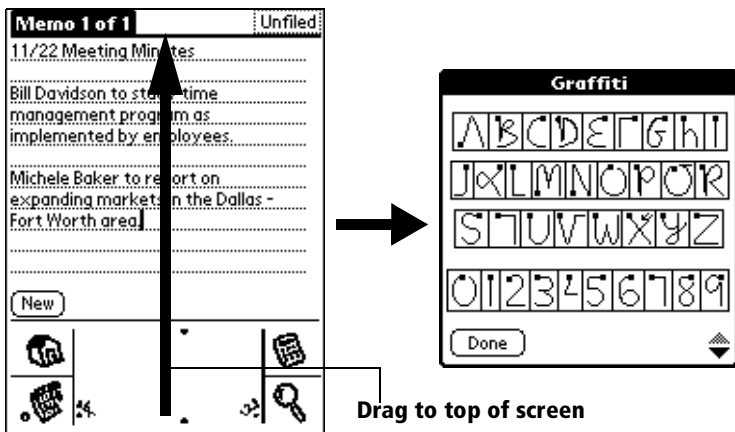

To change the Pen preferences:

1. Tap Pen.

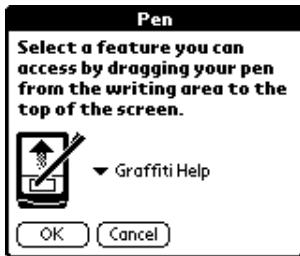

2. Tap the pick list and select one of the following settings for the full-screen pen stroke:

- Backlight** Turns on the backlight of your handheld.
- Keyboard** Opens the onscreen keyboard for entering text characters.
- Graffiti Help** Opens a series of screens that show the complete Graffiti character set.
- Turn Off & Lock** Turns off and locks the handheld. You must assign a password to lock the handheld. When locked, you need to enter the password to use your handheld.
- Beam Data** Beams the current record to another Palm OS® handheld.

3. Tap OK.

HotSync buttons preferences

The Buttons Preferences screen also enables you to associate different applications with the HotSync button on the cradle and the HotSync button on the optional Springboard modem. Any changes that you make in the HotSync Buttons dialog box become effective immediately; you do not have to change to a different screen or application.

To change the HotSync buttons preferences:

1. Tap HotSync.
2. Tap the pick list next to the button you want to assign.

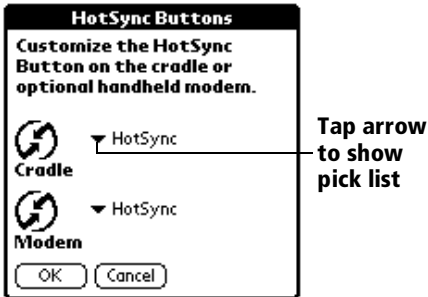

3. Tap the application that you want to assign to each button.
The default setting for each button is the HotSync setting, which means the cradle and optional Springboard modem perform their normal HotSync functions.
4. Tap OK.

Connection preferences

The Connection Preferences screen allows you to create configurations for communicating with a PC or a Modem. Configurations, or profiles, once activated are available to various end-user applications running on the handheld. The Connection Preferences screen displays a list of available configurations that can be modified to reflect the required settings. This list will vary depending on the software you have added to your handheld.

Connection Types

There are six types of connections you can choose from when configuring your preferences:

Serial to PC This connection type defines the direct serial connection between your handheld and your desktop computer. It is used to perform a local HotSync operation when your handheld is connected by its serial connector to the cradle. The cradle is attached by its cable to a serial (COM) port on your desktop computer.

Serial to Modem This connection type defines a connection between a modem attached to the serial connector on your handheld and a modem that is part of your computer or laptop.

USB/Serial to PC This connection type defines a direct serial or USB connection between your handheld and your desktop computer. When you select this option, your handheld detects which type of cradle you have connected to your computer.

USB to PC This connection type defines the direct USB connection between your handheld and your desktop computer. It is used to perform a local HotSync operation when your handheld is connected by its USB connector to the cradle. The cradle is attached by its cable to a USB port on your desktop computer.

IrCOMM to PC This connection type defines a connection between the IR port of your handheld and the infrared device of your computer or laptop.

IrCOMM to Modem This connection type defines a connection between the IR port of your handheld and a modem. The modem can be attached to a computer or some other device containing an IR port.

Setting modem configurations

Modem configurations enable your Visor handheld to use a Springboard modem to communicate with remote devices, such as your ISP or dial-in server.

To connect to remote devices using the TCP/IP software included in the handheld operating system, you must set Network preferences in addition to configuring Modem settings.

Note: You can purchase a Springboard modem for use with your handheld. See www.handspring.com.

To set Serial to Modem preferences:

1. From the Connection Preferences screen, select Standard Modem.

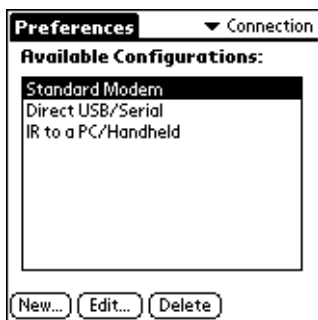

2. Tap Edit.



The name of the current configuration appears at the top of the screen.

3. Tap the Connection Method pick list and select Serial to Modem.
4. Tap the Dialing pick list and select TouchTone or Rotary.

Note: Select Rotary only if your telephone service does not support TouchTone dialing.

5. Tap the Volume pick list and select the speaker volume for the modem.
6. Tap Details.

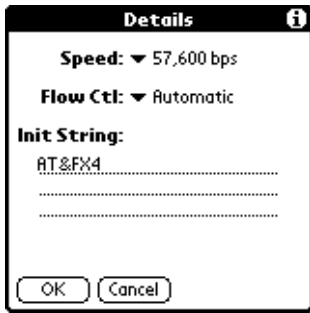

7. Tap the Speed pick list and select the maximum speed for your modem.

Note: This is the speed at which your modem communicates with your handheld, not the speed at which your modem communicates with your telephone service.

8. Tap the Flow Control (Flow Ctl) pick list, and select Automatic, On (Xon), or Off (Xoff) flow control for the modem connection.
9. If needed, edit the Init String to change the modem setup string.
10. Tap OK twice to return to the Connection Preferences screen.

The following steps demonstrate how to create a modem connection that enables IR HotSync through an IR enabled modem. This modem would then dial a modem attached to your desktop to perform the remote HotSync operation.

To create an IrCOMM to Modem connection:

1. In the Connection Preferences screen, tap New.
2. Enter a name for this configuration.
3. Tap the Connection Method pick list and select IrCOMM to Modem.



4. Tap the Dialing pick list and select TouchTone or Rotary.

Note: Select Rotary only if your telephone service does not support TouchTone dialing.

5. Tap the Volume pick list and select the speaker volume.
6. Tap Details.

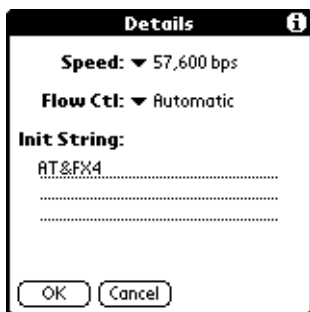

7. Enter the initialization string appropriate for the modem attached to your handheld.
8. Tap OK twice to return to the Connection Preferences screen.

Digitizer preferences

The Digitizer Preferences screen opens the digitizer calibration screen. This is the same screen that appears when you start your handheld for the first time.

You can recalibrate your screen after a hard reset, or if your digitizer drifts.

Formats preferences

Use the Formats Preferences screen to set the country default and the display format of the dates, times, and numbers on your handheld.

Country default

The country default sets date, time, week start day, and number conventions based on geographic regions where you might use your handheld. For example, in the United Kingdom, time often is expressed using a 24-hour clock. In the United States, time is expressed using a 12-hour clock with an AM or PM suffix.

All your handheld applications use the Country default settings. You can, however, customize your own preferences. See the “Time, date, week start, and numbers formats” section later in this chapter.

To set the country default:

1. Tap the country name pick list.

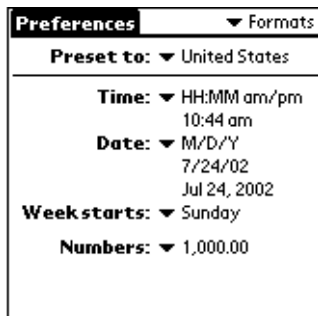

2. Tap the setting you want to use.

Time, date, week start, and numbers formats

The Time setting defines the format for the time of day. The time format that you select appears in all applications on your handheld.

To select the time, date, week start, and numbers format:

1. Tap the Time pick list and select a format.
2. Tap the Date pick list and select a format.
3. Tap the Week starts pick list, and select whether you want the first day of the week to be Sunday or Monday.

Note: This setting controls the Day, Week, Month, Year, and List views in Date Book Plus and all other aspects of your handheld that display a calendar.

4. Tap the Numbers pick list, and select formats for the decimal point and thousands separator.

General preferences

The General Preferences screen enables you to set the time, date, auto shutoff interval, and sounds for your handheld.

See Chapter 1 for information on setting the time and date.

Auto-off delay

Your handheld has an automatic shutoff feature that turns off the power and backlight after a period of inactivity. This feature helps conserve battery power in case you forget to turn off your handheld.

If you find that your handheld shuts itself off before you finish reviewing the information on the screen, you should increase the time setting of the automatic shutoff feature.

To set the Auto-off delay:

1. Tap the Auto-off pick list.
2. Tap the setting you want to use for the automatic shutoff feature: 30 seconds, 1 minute, 2 minutes, or 3 minutes.

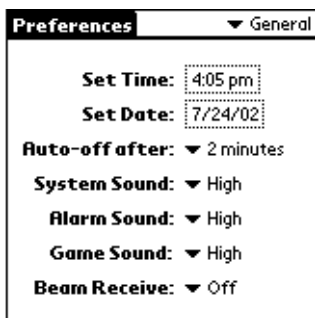

System, alarm, and game sounds

Your handheld uses a variety of sounds. The System, Alarm, and Game Sound settings enable you to turn the sounds on or off, and to adjust the volume level.

To set the system and alarm sounds:

1. Tap the System Sound pick list and select the sound level.

Note: When you turn off the System Sounds, you also turn off the “chime” tones associated with the HotSync operation.

2. Tap the Alarm Sound pick list and select the sound level.
3. Tap the Game Sound pick list and select the sound level.

Note: The Game Sound setting works only with games that are programmed to respond to this setting. Older games typically do not respond to this setting.

Network preferences and TCP/IP software

Network Preferences let you set a password, telephone number, DNS number, IP address, as well as create a login script for remote connections. You can use a preset service template for your ISP or dial-in server, and edit, save, and reuse settings. Or you can create your own service template.

The Network Preferences settings also enable you to use the TCP/IP software that is included in the handheld operating system. You can use the TCP/IP software to connect with Internet Service Providers (ISPs) or dial-in (remote access) servers. Because the TCP/IP software is a feature of the operating system, you configure all parameters relating to it from the Preferences application.

To use TCP/IP, you must first configure the Connection Preferences and then the Network Preferences settings.

After you configure both the Network and Connection Preferences, you can establish a PPP (Point-to-Point Protocol), SLIP (Serial Line Internet Protocol), or CSLIP (Compressed Serial Line Internet Protocol) connection with your ISP or dial-in server. You can do this either by using menu commands from the Network Preferences screen or by using a third-party application.

Note: TCP/IP provides the ability to connect to your ISP or dial-in server with applications that allow you to view the transmitted data. Visit the web site www.handspring.com for information on third-party applications that take advantage of TCP/IP.

Selecting a service

Use the Service setting to select the service template for your Internet Service Provider or a dial-in server. Service templates are a set of ISP and dial-in server configuration settings that you can create, save, and reuse.

To select a service:

1. Tap the Service pick list.

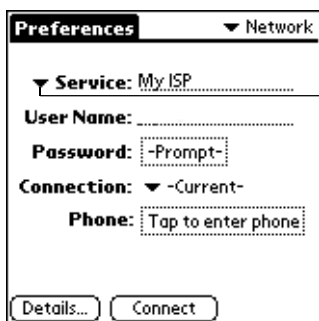

The screenshot shows a 'Preferences' dialog box with a 'Network' dropdown menu. The 'Service' field is expanded to show a list of service templates. The 'User Name' field is empty, the 'Password' field is set to '-Prompt-', the 'Connection' field is set to '-Current-', and the 'Phone' field is set to 'Tap to enter phone'. There are 'Details...' and 'Connect' buttons at the bottom.

Tap here to display a list of service templates

2. Tap the predefined service template you want to use or enter a name for a new service template.

Entering a user name

The User Name setting identifies the name you use when you log into your Internet Service Provider or your dial-in server. Although this field can contain multiple lines of text, only two lines appear onscreen.

To enter a user name:

1. Tap the User Name field.
2. Enter your user name.

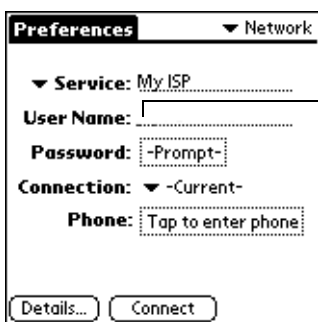

The screenshot shows the same 'Preferences' dialog box as above, but the 'User Name' field is now highlighted with a black border, indicating it is the active field for text entry.

Enter your user name here

Note: Most dial-in servers do not accept spaces in the user name.

Entering a password

The Password box identifies the password you use to log into your server or ISP. Your entry in this field determines whether your handheld prompts you to enter a password each time you log into your network:

- If you do not enter a password, your handheld displays the word “Prompt” in this field and asks you to enter a password during the login procedure.
- If you enter a password, your handheld displays the word “Assigned” in this field and does not prompt you to enter a password during the login procedure.

Note: If you are concerned about security, select the Prompt option and do not enter a password.

To enter a password:

1. Tap the Password field.
2. Enter the password you use to log into your server.

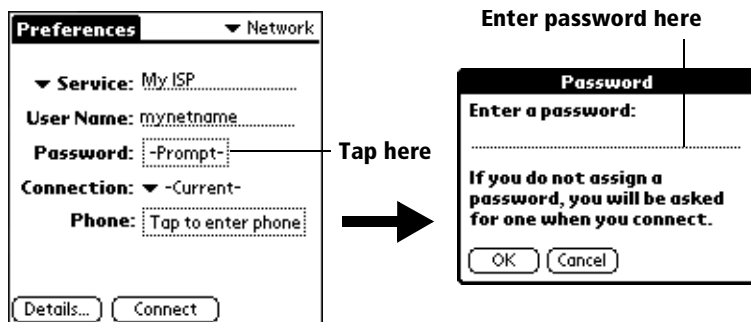

3. Tap OK.

Note: The Password field updates to display the word “Assigned.”

Selecting a connection

The Connection Preferences settings enable your Visor handheld to use a modem to communicate with remote devices. For example, you can communicate with your ISP server, or with your computer if you are away on travel. See “Connection preferences” earlier in this chapter for a complete explanation on how to configure Connection Preferences.

1. Tap the Connection pick list.

The list displays the configurations in your Connection Preferences panel.

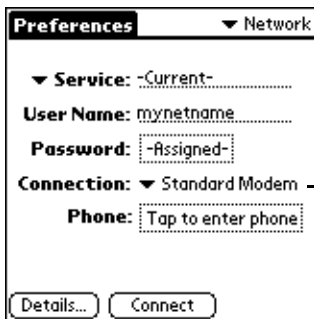

The screenshot shows a dialog box titled "Preferences" with a "Network" dropdown menu. The fields are: "Service: -Current-", "User Name: mynetname", "Password: -Assigned-", "Connection: Standard Modem", and "Phone: Tap to enter phone". At the bottom are "Details..." and "Connect" buttons.

Tap to display a list of connection configurations

2. Select the appropriate Connection.

Adding telephone settings

When you select the Phone field, your handheld opens a dialog box in which you define the telephone number you use to connect with your ISP or dial-in server. In addition, you can also define a prefix, disable Call Waiting, and give special instructions for using a calling card.

Note: The Phone Setup dialog box works correctly for AT&T and Sprint long-distance services. However, because MCI works differently, MCI customers need to put the calling card number in the Phone # field and the phone number in the Use calling card field.

To enter your server phone number:

1. Tap the Phone field.
2. Enter the phone number you use to reach your ISP or dial-in server.

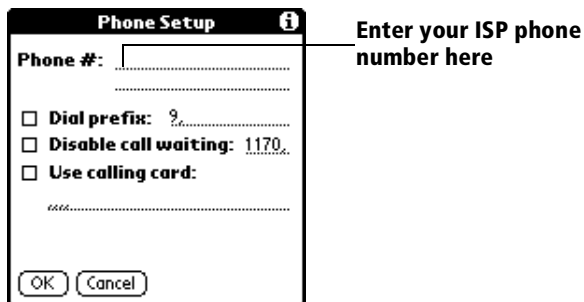

3. If you need to enter a prefix or disable Call Waiting, skip to those procedures. Otherwise, tap OK.

Entering a prefix

A prefix is a number that you dial before the telephone number to access an outside line. For example, many offices require that you dial "9" to dial a number outside the building.

To enter a prefix:

1. Tap the Dial Prefix check box to select it.

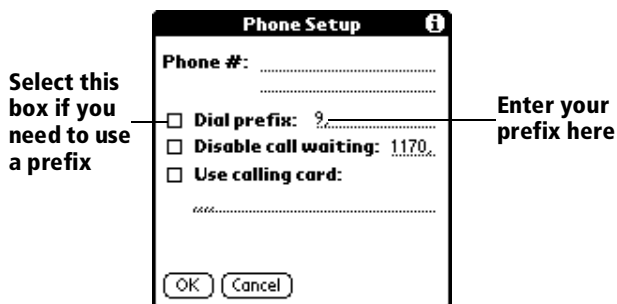

2. Enter the prefix.
3. Tap OK.

Disabling Call Waiting

Call Waiting can cause your session to terminate if you receive a call while you are connected. If your telephone has Call Waiting, you need to disable this feature before logging into your ISP or dial-in server.

To disable Call Waiting:

1. Tap the Disable call waiting check box to select it.

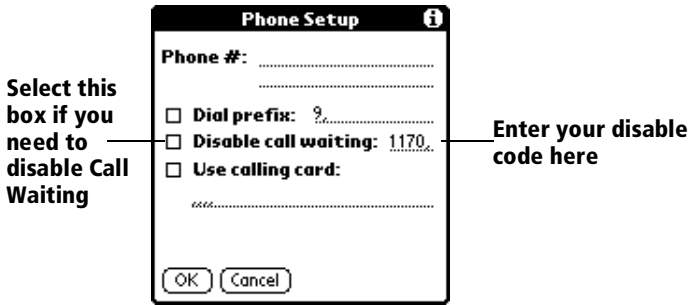

2. Enter the code to disable Call Waiting on the Disable call waiting line.

Note: Each telephone company assigns a code to disable Call Waiting. Contact your local telephone company for the code that is appropriate for you.

3. Tap OK.

Using a calling card

The Use calling card field enables you to use your calling card when dialing your ISP or Intranet server. Keep in mind that there is usually a delay before you enter your calling card number. When you define your calling card number, you need to add commas at the beginning to compensate for this delay. Each comma delays transmission of your calling card number for two seconds.

To use a calling card:

1. Tap the Use calling card check box to select it.

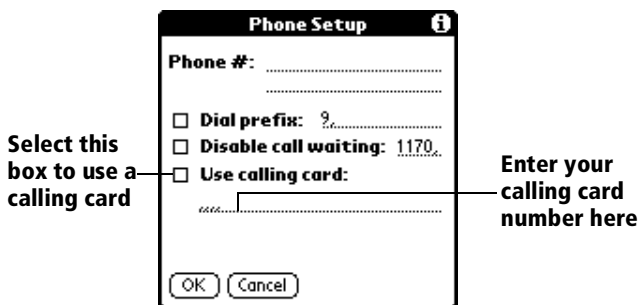

2. Enter your calling card number on the Use calling card line.

Note: It's a good idea to add at least three commas at the beginning of your calling card number to compensate for the cue delay.

Tip: MCI customers must enter the calling card number in the Phone # field, and the phone number in the Use Calling Card field.

3. Tap OK.

Connecting to your service

After you set your Connection and Network Preferences, establishing a connection to your Internet Service Provider (ISP) or your company's network (dial-in server) is easy.

Note: If you are connecting to an ISP, you need a third-party application, such as a web browser or news reader, to take advantage of this connection. For information about third-party applications that support TCP/IP, check the web site www.handspring.com.

To establish a connection:

- Tap Connect to dial the current service and display the Service Connection Progress messages.

Tip: To see expanded Service Connection Progress messages, press the bottom scroll button.

To close a connection:

- Tap Disconnect to terminate the connection between your handheld and your service.

Creating additional service templates

You can create additional service templates from scratch or by duplicating existing templates and editing information. After you create a new or duplicate template, you can add and edit settings.

To add a new service template:

1. Tap the Menu icon .
2. Tap Service, and then tap New.

A new service template (called Untitled) is added to the Service pick list.

To duplicate an existing service template:

1. Tap the Service pick list.
2. Tap the predefined service template you want to duplicate.
3. Tap the Menu icon .
4. Tap Service, and then tap Duplicate.

A copy of the service template is added to the Service pick list.

Adding detailed information to a service template

If you are using one of the predefined service templates, you probably only need to enter your user name and telephone number. If you are creating a new service template, you may need to provide additional information to your ISP or dial-in server. You use the Details dialog box to add additional information to a selected service template.

To select a connection type:

1. Tap the service field.
2. Tap Details.

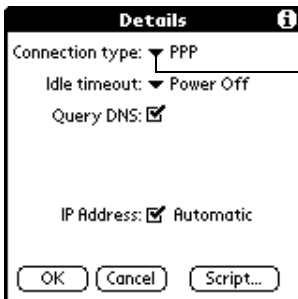

Select connection type

3. Tap the Connection type pick list and select one of the following connection types:

PPP	Point-to-Point protocol
SLIP	Serial Line Internet Protocol
CSLIP	Compressed Serial Line Internet Protocol

Note: If you are not sure, try PPP; if that doesn't work, ask your Internet Service Provider or your System Administrator for the correct connection type.

Idle timeout

The Idle timeout setting defines how long your handheld waits before dropping the connection with your ISP or dial-in server when you switch out of a TCP/IP application.

To set the Idle timeout:

1. Tap the Idle timeout pick list and select one of the following options:

Immediate	Drops the connection to your ISP immediately when you switch to another application.
1 minute	Waits one minute for you to open another application before it drops the connection.
2 minutes	Waits two minutes.
3 minutes	Waits three minutes.
Power Off	Keeps your PPP or SLIP connection until you turn off your handheld (or until it times out). This option works best with the Springboard modem.

2. Tap OK.

Defining primary and secondary DNS

The Domain Naming System (DNS) is a mechanism in the Internet for translating the names of host computers into IP addresses. When you enter a DNS number (or IP address), you are identifying a specific server that handles the translation services.

Each IP address has four sections, separated by periods. In the Details dialog box, you enter each section separately. Each section of an IP address is made up of a number from 0 to 255; numbers are the only allowable characters in this field.

Ask your Internet Service Provider or System Administrator for the correct Primary or Secondary DNS IP numbers.

Tip: Many systems do not require that you enter a DNS. If you are not sure, leave the DNS field blank.

To enter a primary and secondary DNS:

1. Tap the Query DNS check box to deselect it.
2. Tap the space to the left of the first period in the Primary DNS field, and then enter the first section of the IP address.

Note: Each section must be a number from 0 to 255.

3. Repeat step 2 for the second, third, and last sections of the Primary DNS field.
4. Repeat steps 2 and 3 for the Secondary DNS number.
5. Tap OK.

IP address

Everyone who logs on to the Internet needs to have a unique identifier (an IP address), whether permanent or temporary. Some networks dynamically assign a temporary IP address when clients log in. The IP Address field lets you identify whether your network provides automatic (dynamic) temporary IP addressing.

Note: If your IP address is permanently assigned, you need to get that information from your System Administrator. If you are not sure, select Automatic.

To identify dynamic IP addressing:

- Tap the IP Address check box to select it.

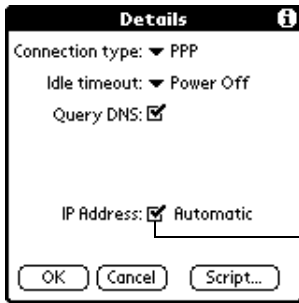

Tap to select automatic IP address

To enter a permanent IP address:

1. Tap the IP Address check box to deselect it and display a permanent IP address field below the check box.
2. Tap the space to the left of the first period then enter the first section of the IP address.

Note: Each section must be a number from 0 to 255.

3. Tap and enter the remaining sections of the IP address.
4. Tap OK.

Creating a login script

A login script is a series of commands, similar to an autoexec.bat file, that automates logging into your ISP. You can create login script files by selecting commands from the Command pick list in the Login Script dialog. Some commands from the Command pick list, such as Send, require you to supply additional information. Those commands have a parameter field so that you can add the necessary data.

Note: You can also use non-ASCII and literal characters in your login script. See Appendix C for more information.

To create a login script:

1. Tap Script.
2. Tap the End pick list.

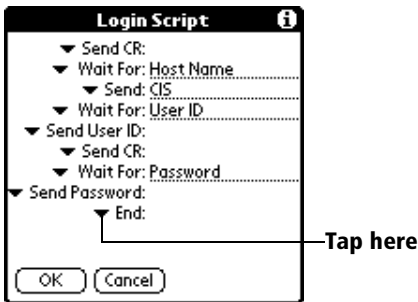

3. Tap the command you want from the Command list. If the command requires additional information, a field appears to the right of it for you to enter the information. The following commands are available:

Wait For Tells your handheld to wait for specific characters from the TCP/IP server before executing the next command.

Wait For Prompt Detects a challenge-response prompt from the server and displays a dynamically generated challenge value. When you enter the challenge value into your token card, this generates a response value for you to enter on your handheld. This command takes two arguments, separated by a vertical bar (|) on the input line.

Send Transmits specific characters to the TCP/IP server to which you are connecting.

Send CR Transmits a carriage return or LF character to the TCP/IP server to which you are connecting.

Send User ID Transmits the User ID information entered in the User ID field of the Network Preferences screen.

Send Password	Transmits the password entered in the Password field of the Network Preferences screen. If you did not enter a password, this command prompts you to enter one. The Password command is usually followed by a Send CR command.
Delay	Tells your handheld to wait a specific number of seconds before executing the next command in the login script.
Get IP	Reads an IP address and uses it as the IP address for your handheld. This command is used with SLIP connections.
Prompt	Opens a dialog box and prompts you to enter text of some kind (for example, a password or a security code).
End	Identifies the last line in the login script.

4. Repeat steps 2 and 3 until the login script is complete.
5. Tap OK.

Deleting a service template

There is only one way to delete a service template: use the Delete command from the Service menu.

To delete a service template:

1. Tap the Service pick list.
2. Tap the service template you want to delete.
3. Tap the Menu icon .
4. Tap Service, and then tap Delete.
5. Tap OK.

Network preferences menu commands

The Network Preferences screen includes menu commands to make it fast and easy to create and edit service templates. TCP/IP application menus are show here for your reference.

See “Using menus” in Chapter 1 for more information about choosing menu commands.

Service menu

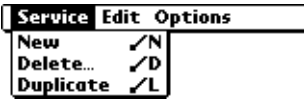

Options menu



TCP/IP troubleshooting

If you are having a problem establishing a network connection using TCP/IP, check this section and try the suggestions listed.

Displaying expanded Service Connection Progress messages

It's helpful to identify at what point in the login procedure the connection fails. An easy way to do this is to display the expanded Service Connection Progress messages. Expanded Service Connection Progress messages describe the current stage of the login procedure. Press the bottom scroll button at any point during login to display these messages.

Viewing the Network Log

If viewing the expanded Service Connection Progress messages does not give you enough information to find out why you cannot connect to your ISP or dial-in server, take a look at the Network Log. The Network Log lists all of the communication that occurs between your modem and your dial-in server during the login procedure. The information in the Network Log can help your ISP or your System Administrator pinpoint where the login procedure communication fails and why.

To view the Network Log:

1. Tap Options, and then tap View Log.
2. Tap the up and down arrows of the scroll bar to see the entire Network Log.
3. Tap Done.

Adding a DNS number

If your ISP or dial-in server requires a DNS number and you did not enter that information in the Network Preferences screen, it will appear that you successfully logged into your network. When you try to use an application or look up information, however, the connection fails. If this occurs, try adding a DNS number. Ask your ISP or your System Administrator for the correct Primary and Secondary DNS IP numbers.

Owner preferences

The Owner Preferences screen enables you to record a name, company name, phone number, or any other information that you want to associate with your handheld.

If you use the Security application to turn off and lock your handheld with a password, information that you put in the Owner Preferences displays the next time you turn on your handheld. See Chapter 1 for more information.

To enter the Owner preferences:

- Enter the text that you want to associate with your handheld in the Owner Preferences screen. If you enter more text than can fit on one screen, a scroll bar automatically appears on the right side of the screen.



The screenshot shows a screen titled "Preferences" with a dropdown menu set to "Owner". The screen contains a form with the following text and input fields:

- This device is owned by:
- Midyne Spear
- Creative Spearit
- Bonny Doon, CA
- 408-555-1212
- If found, please contact me.
-
-

If you assign a password with the Security application, the information in the Owner Preferences screen cannot be changed. In this case, an Unlock button appears at the bottom of the screen.

To unlock the Owner Preferences screen:

1. Tap Unlock.
2. Enter the password that you defined in the Security application.
3. Tap OK.

ShortCuts preferences

The ShortCuts Preferences screen enables you to define abbreviations for entering text with Graffiti strokes. This section describes how to create, edit, and delete a ShortCut. See Chapter 2 for more information on the use of ShortCuts.

Creating a ShortCut

You can create a ShortCut for any words, letters, or numbers. All ShortCuts you create appear on the list in the ShortCut Preferences screen. All the ShortCuts are available in any of your handheld applications and are backed up on your computer when you perform a HotSync operation.

To create a ShortCut:

1. Tap New.
2. On the ShortCut name line, enter the letters you want to use to activate the ShortCut.

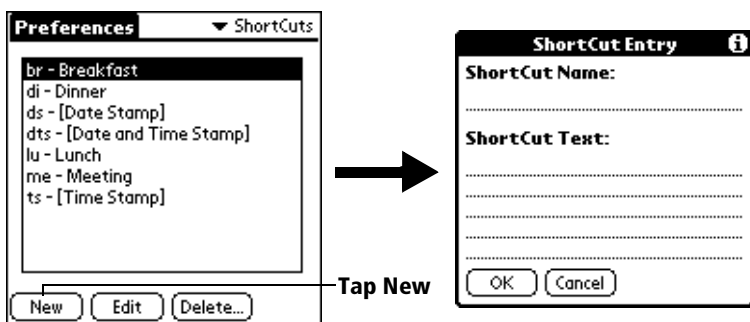

3. Tap the ShortCut Text area and enter the text that you want to appear when you write the ShortCut characters.

Tip: You may want to add a space (space character) after the last word in your ShortCut text. This way, a space automatically follows the ShortCut text.

4. Tap OK.

Tip: To use a ShortCut, draw the ShortCut stroke followed by the ShortCut characters. When you draw the ShortCut stroke, the ShortCut symbol appears at the insertion point to show that you are in ShortCut mode.



Editing a ShortCut

After you create a ShortCut, you can modify it at any time.

To edit a ShortCut:

1. Tap the ShortCut you want to edit.
2. Tap Edit.
3. Make the changes you want and tap OK.

Deleting a ShortCut

If you no longer need a ShortCut, you can delete it from the list of ShortCuts.

To delete a ShortCut:

1. Tap the ShortCut you want to delete.
2. Tap Delete.
3. Tap Yes.

Appendix A

Maintaining Your Handheld

This chapter provides information on the following:

- Proper care of your handheld
- Prolonging battery life
- Resetting your handheld

Caring for your handheld

Your handheld is designed to be rugged and reliable and to provide years of trouble-free service. Please observe the following general tips when using your handheld:

- Take care not to scratch the screen of your handheld. Keep the screen clean. When working with your handheld, use the supplied stylus or plastic-tipped pens intended for use with a touch-sensitive screen. Never use an actual pen or pencil or other sharp object on the surface of the handheld screen.
- Your handheld is not waterproof and should not be exposed to rain or moisture. Under extreme conditions, water may enter the circuitry through the front panel buttons. In general, treat your handheld as you would a pocket calculator or other small electronic instrument.
- The touch-sensitive screen of your handheld contains a glass element. Take care not to drop your handheld or subject it to any strong impact. Do not carry your handheld in your back pocket: if you sit on it, the glass may break.
- Protect your handheld from temperature extremes. Do not leave your handheld on the dashboard of a car on a hot day, and keep it away from heaters and other heat sources.
- Do not store or use your handheld in any location that is extremely dusty, damp, or wet.
- Use a soft, damp cloth to clean your handheld. If the surface of the handheld screen becomes soiled, clean it with a soft cloth moistened with a diluted window-cleaning solution.

Battery considerations

Please note the following considerations when replacing the batteries in your handheld:

- Under normal conditions, your handheld batteries should provide several months of use. You can conserve battery life by minimizing the use of the backlight feature, and changing the Auto-off setting that automatically turns the handheld off after a period of inactivity. See “General preferences” in Chapter 9 for more information.
- If the batteries become low in the course of normal use, an alert appears on the handheld screen describing the low battery condition. If this alert appears, perform a HotSync® operation to back up your data before you replace the batteries. This helps prevent accidental data loss.
- When replacing the batteries, begin by turning your handheld off (so there is no screen display). Never remove the batteries while your handheld is turned on.
- When replacing the batteries, always use good quality batteries of the same type. Use only alkaline batteries with your handheld.
- When you remove the batteries, the built-in backup power of your handheld maintains memory data **for a period of up to one minute**. Whenever you remove the batteries, replace them immediately. If you encounter any difficulties in the course of battery replacement, reinstall the original batteries and wait a few minutes for the backup power to recharge.
- If the batteries drain to the point where your handheld does not operate, it stores your data safely for about a month. In this case, there is enough residual energy in the batteries to store the data, but not enough to turn on your handheld. If your handheld does not turn on when you press the power button, you should replace the batteries immediately.
- If you leave drained batteries in your handheld for an extended period of time, you can lose all of the stored data. If this happens, replace the batteries and use the reset button to reset your handheld. (See “Resetting your handheld” later in this chapter for details.) After you reset your handheld, perform a HotSync operation to restore the data from your computer.

Resetting your handheld

Under normal circumstances, you will not have to use the reset button. On rare occasions, however, your handheld may no longer respond to buttons or the screen. In this case, you need to perform a reset to get your handheld running again.

Performing a soft reset

A soft reset tells your handheld to stop what it's doing and start over again. All records and entries stored in your handheld are retained with a soft reset. After a soft reset, the Welcome screen appears, followed by the General Preferences screen (to set time and date).

To perform a soft reset:

1. Unscrew the tip of the stylus to access the reset tool.

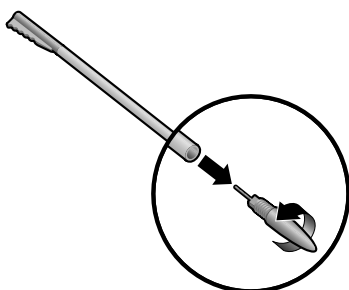

2. Use the reset tool to gently press the reset button inside the hole on the back panel of your handheld.

Tip: You can also use the tip of an unfolded paper clip (or similar object *without* a sharp tip).

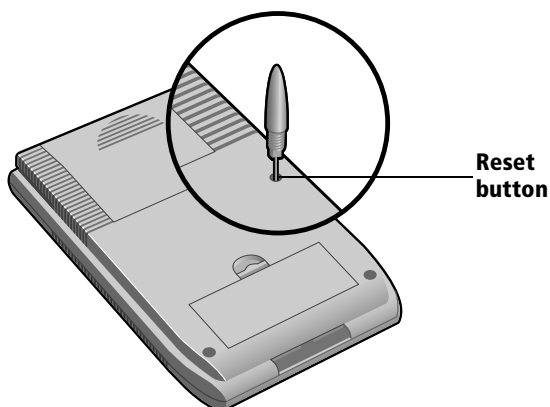

Performing a warm reset

A warm reset bypasses system extensions on your handheld, such as HackMaster hacks or system patches. Performing a warm reset enables you to uninstall a third-party application that may be causing a problem.

To perform a warm reset:

1. Hold down the Page Up button on the front panel of the handheld.
2. While holding down the Page Up button, use the reset tool (or similar object *without* a sharp tip) to gently press the reset button.
3. When the Palm Computing logo appears, release the Page Up button.

Performing a hard reset

With a hard reset, all records and entries stored in your handheld are erased. Never perform a hard reset unless a soft reset does not solve your problem.

Note: You can restore any data previously synchronized with your computer during the next HotSync operation.

To perform a hard reset:

1. Hold down the power button on the front panel of the handheld.
2. While holding down the power button, use the reset tool (or similar object *without* a sharp tip) to gently press the reset button.
3. Release the power button.
4. When a message appears on the handheld screen warning that you are about to erase all the data stored on your handheld, do one of the following:

Press the top scroll button on the front panel of your handheld to complete the hard reset and display the Digitizer screen.

Press any other button to perform a soft reset.

Note: With a hard reset, the current date and time are retained. Formats Preferences and other settings are restored to their factory default settings.

To restore your data after a hard reset:

1. Open Palm Desktop software.
2. From the HotSync menu, choose Conduit Settings.

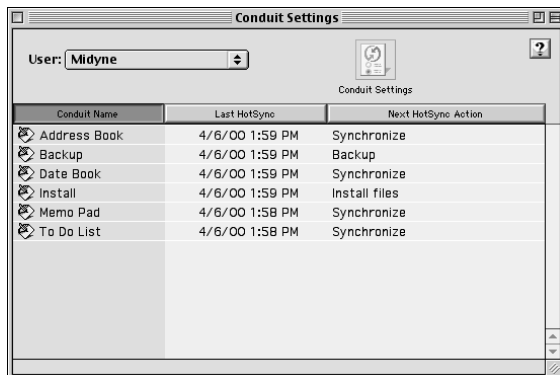

3. From the User pop-up menu, select your user name.
4. Select an application in the Conduit list.
5. Click Conduit Settings.

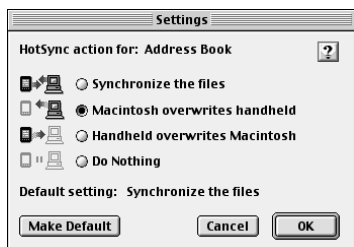

6. Select Macintosh overwrites handheld.

Note: Changing the HotSync setting from the default affects only the *next* HotSync operation. Thereafter, the HotSync Actions revert to their default settings. To use a new setting on an ongoing basis, click Make Default. Thereafter, whatever you selected as the default setting is used when you perform a HotSync operation.

7. Click OK.
8. Repeat steps 4 through 7 to change conduit settings for other applications.
9. Close the Conduit Settings dialog box.
10. Perform a HotSync operation.

Appendix B

Troubleshooting Tips

If you encounter a problem with your Visor handheld:

- Review this section to see if your problem is listed
- Check our web site at www.handspring.com for the latest technical support information

Note: Thousands of third-party add-on applications have been written for Palm OS® handhelds. Unfortunately, we are not able to support such a large number of third-party applications. *If you are having a problem with a third-party application, please contact the developer or publisher of that software.*

Operating problems

Problem

Solution

My handheld won't turn on.

Try each of these in turn:

- Adjust the contrast control.
- Make sure the batteries are installed properly.
- Replace the batteries.
- Perform a soft reset; see Appendix A.
- If your handheld still does not operate, try a hard reset; see Appendix A.

I replaced the batteries, but I am still getting a low battery warning.

The battery warning message may appear immediately after replacing the batteries. Also, if you check the battery gauge in the Applications Launcher *immediately* after replacing the batteries, the gauge may start at "empty" and slowly rise to "full." This is normal. It takes a few minutes for the battery gauge to accurately show the condition of the batteries.

My handheld keeps turning itself off.

Your handheld is designed to turn itself off after a period of inactivity. This period can be set at one, two, or three minutes. Check the Auto-off setting. See "General preferences" in Chapter 9.

My handheld is not making any sounds.

Check the System Sound setting. See "General preferences" in Chapter 9.

My handheld has frozen.

Perform a soft reset. See "Resetting your handheld" in Appendix A.

I don't see anything on my handheld's screen.

- Change the contrast settings.
- Replace the batteries.
- Perform a soft reset.

Tapping and writing problems

Problem

When I tap the buttons or screen icons, it activates the wrong feature.

When I tap the Menu icon , nothing happens.

I can't get my handheld to recognize my handwriting.

Solution

Calibrate the screen. See "Digitizer preferences" in Chapter 9.

Not all applications or screens have menus. Try changing to a different application.

- For your handheld to recognize handwriting input with the stylus, you need to use Graffiti® writing. See "Using Graffiti writing to enter data" in Chapter 2.
- Make the Graffiti character strokes in the Graffiti writing area, not on the display part of the screen.
- Write Graffiti strokes for letters in the left-hand side, and the strokes for numbers in the right-hand side of the Graffiti writing area.
- Make sure that Graffiti is not shifted into extended or punctuation modes. See "Using Graffiti writing to enter data" in Chapter 2.
- See "Graffiti tips" in Chapter 2 for tips on increasing your accuracy when you write Graffiti characters.

Application problems

Problem

I tapped the Today button, but it does not show the correct date.

I know I entered some records, but they do not appear in the application.

I am having problems listing memos the way I want to see them.

I created an event in Date Book Plus, but it doesn't appear in the Week View.

Solution

Your handheld is not set to the current date. Make sure the Set Date box in the General Preferences screen displays the current date. See "General preferences" in Chapter 9 for more information.

- Check the Categories pick list (upper-right corner of the screen). Choose All to display all of the records for the application.
- Check Security and make sure that the Private Records setting is set to Show private records.
- In To Do List, tap Show and check whether Show Only Due Items is selected.
- If you cannot manually arrange the order of the memos in the list screen, check the Memo Preferences setting. Make sure that Sort by is set to Manual.
- If you choose to view your memos alphabetically on Palm Desktop software and then perform a HotSync® operation, the memos on your handheld still appear in the order defined in the Memo Preferences setting. In other words, the sort settings that you use with Palm Desktop software *are not* transferred to your handheld.

In the Week View, you cannot select overlapping events that have the same start time. If you have two or more events with the same start time, choose the Day View for the particular day to see the overlapping events.

HotSync problems

Problem

I cannot do a HotSync operation; what should I check to make sure I am doing it correctly?

Solution

- Perform a soft reset. See “Resetting your handheld” in Appendix A.
- Make sure the HotSync Manager is enabled. Open Palm Desktop software, from the HotSync menu, choose Setup. Make sure that the Enabled option is selected.
- Check the HotSync Manager Local Setup settings. Open Palm Desktop software, from the HotSync menu, choose Setup. Click the Serial Port Settings tab and make sure Local option is selected and that the Speed and Port settings match the port where you attached the cradle.
- Make sure the cradle is connected securely to your computer.
- Make sure your handheld is seated securely in the cradle.
- Make sure you installed the software that came with your handheld. You must install this software even if you upgraded from a Palm organizer.
- Make sure you are using the correct type of cradle. If your computer does not have a USB port, or is running MacOS 8.0 or earlier, you must use a serial cradle.

I did a HotSync operation, but one of my applications did not synchronize.

- Make sure the correct options are selected in the Conduit Settings dialog box.

I cannot launch the HotSync Manager.

- Make sure you are not running another program, such as America Online, CompuServe, or WinFax, that uses the port you selected in the Setup dialog box.
- Reinstall the Palm Desktop software.

I tried to do a local HotSync operation, but it did not complete successfully.

Try each of these in turn:

- Make sure the HotSync Manager is enabled. Open Palm Desktop software, from the HotSync menu, choose Setup. Make sure that the Enabled option is selected.
- Check the HotSync Manager Local Setup settings. Open Palm Desktop software, from the HotSync menu, choose Setup. Click the Serial Port Settings tab and make sure Local option is selected and that the Speed and Port settings match the port where you attached the cradle.
- Check the cable connection between the cradle and the port on your computer.
- Make sure you installed the software that came with your handheld. You must install this software even if you upgraded from a Palm organizer.
- Make sure you selected your user name in Palm Desktop software before beginning the HotSync operation.
- Make sure you are not running another program, such as America Online or CompuServe that uses the port you selected in the Setup dialog.
- Make sure your handheld is seated in the cradle correctly.
- Perform a soft reset. See "Resetting your handheld" in Appendix A.

I tried to do a modem HotSync operation, but it did not complete successfully.

Check the following on your computer:

- Make sure your computer is turned on and that it does not shut down automatically as part of an energy-saving feature.
- Make sure the modem connected to your computer is turned on and is connected to the outgoing phone line.
- Make sure the HotSync Manager is enabled. Open Palm Desktop software, from the HotSync menu, choose Setup. Make sure that the Enabled option is selected.
- Check the HotSync Manager Modem Setup settings. Open Palm Desktop software, from the HotSync menu, choose Setup. Click the Serial Port Settings tab and make sure the Modem Setup option is selected and that the Modem and Port settings match your computer modem.
- Make sure the modem you are using with your handheld has an on-off switch. Your handheld cannot “wake up” a modem that has an auto-off feature.
- Make sure the modem is connected properly to a port on your computer and is connected to the incoming phone line.
- You may need to select a different Modem Type or enter a custom Setup String. Most modems have a Setup String that causes them to send initial connection sounds to a speaker. You can use these sounds to check the modem connection.

I tried to do a modem HotSync operation, but it did not complete successfully.
(continued)

Check the following on your computer:
(continued)

- Make sure you are not running another program, such as WinFax, CompuServe, or America Online, that uses the serial port you selected in the Setup dialog box.
- Make sure your modem resets before you try again. (Turn off your modem, wait a minute, then turn it back on.)

Check the following on your handheld:

- Confirm that the telephone cable is securely attached to your modem.
- Make sure the dialing instruction dials the correct phone number.
- If you need to dial an outside line prefix, make sure you selected the Dial Prefix option on your handheld and entered the correct code.
- If the telephone line you are using has Call Waiting, make sure you selected the Disable call waiting option under Modem Sync Phone Setup on your handheld and entered the correct code.
- Make sure the telephone line you are using is not noisy, which can interrupt communications.
- If you are using an external modem, make sure your modem resets before you try again. (Turn off your modem, wait a minute, then turn it back on.)
- Check the batteries in your modem and replace them if necessary.

Beaming problems

Problem

I cannot beam data to another Palm OS handheld.

Solution

- Confirm that your handheld and the other Visor handheld are between ten centimeters (approximately 4") and one meter (approximately 39") apart, and that the path between the two devices is clear of obstacles. Beaming distance to other Palm OS handhelds may be different.
- Check the General Preferences screen and make sure the Beam Receive setting is on.
- Move your handheld closer to the receiving device.
- Perform a soft reset. See "Performing a soft reset" in Appendix A for more information.

When someone beams data to my handheld, I get a message telling me it is out of memory.

- Your handheld requires at least twice the amount of memory available as the data you are receiving. For example, if you are receiving a 30K application, you must have at least 60K free.
- Perform a soft reset. See "Performing a soft reset" in Appendix A for more information.

Password problems

Problem

I forgot the password, and my handheld is not locked.

Solution

You can use Security to delete the password. If you do this, your handheld deletes all entries marked as private. You can, however, perform a HotSync operation *before* you delete the password: the HotSync process backs up all entries, whether or not they are marked private. In this case, the following procedure restores your private entries and lets you access them:

1. Use the Palm Desktop software and the cradle to synchronize your data.
2. Tap Forgotten Password in Security to remove the password and delete all private records.
3. Perform a HotSync operation to synchronize your data and restore the private records by transferring them from your computer to your handheld.

I forgot the password and my handheld is locked.

- If you assign a password and lock your handheld, you must perform a hard reset to continue using your handheld. See "Performing a hard reset" in Appendix A for more information.



Technical support

If you cannot solve your problem after reviewing the sources listed at the beginning of this appendix, check our web site www.handspring.com for the latest technical support information.

Before requesting support, please experiment a bit to reproduce and isolate the problem. When you do contact support, please be ready to provide the following information:

- The name and version of the operating system you are using
- The actual error message or state you are experiencing
- The steps you take to reproduce the problem
- The version of handheld software you are using and available memory

To find version and memory information:

1. Tap the Applications icon .
2. Tap the Menu icon .
3. Tap App, and then tap Info.

Note: Thousands of third-party add-on applications have been written for Palm OS handhelds. Unfortunately, we are not able to support such a large number of third-party applications. *If you are having a problem with a third-party application, please contact the developer or publisher of that software.*

4. Tap Version to see version numbers, and tap Size to see the amount of free memory, in kilobytes.

Appendix C

Non-ASCII Characters for Login Scripts

The following information enables you to create custom login scripts that require non-ASCII characters. It is provided for advanced users who understand the use and requirements of such characters in a custom login script.

Use of ^char

You may use the caret (^) to transmit ASCII command characters. If you send ^*char*, and the ASCII value of *char* is between @ and _, then the character is automatically translated to a single-byte value between 0 and 31.

For example, ^M is converted to a carriage return. If *char* is a value between a and z, then the character sequence is translated to a single-byte value between 1 and 26. If *char* is any other value, then the character sequence is not subject to any special processing.

For example, the string "Joe^M" transmits Joe, followed by a carriage return.

Carriage return and line feed

You may include carriage return and line feed commands as part of the login script, when entered in the following format:

<cr>	Sends or receives a carriage return
<lf>	Sends or receives a line feed

For example, the string "waitfor Joe<cr><lf>" waits to receive Joe followed by a carriage return and line feed from the remote computer before executing the next command in the script.

Literal characters

The backslash (\) character defines that the *next character* is transmitted as a literal character, and is not subject to any special processing ordinarily associated with that character.

Examples:

- \^ Includes a caret as part of the string
- \< Includes a < as part of the string
- \\ Includes a backslash as part of the string

Warranty and Other Product Information

Handspring, Inc. Limited Warranty

HARDWARE: Handspring, Inc. ("Handspring"), warrants to the original end user ("Customer") that this product will be free from defects in workmanship and materials, under normal intended use, for one year from the date of original purchase from Handspring. Handspring's sole obligation under this express warranty shall be, at Handspring's option and expense, to replace the product or part with a comparable product or part, repair the product or part, or if neither repair nor replacement is reasonably available, Handspring may, in its sole discretion, refund to Customer the purchase price paid for the product or part. Replacement products or parts may be new or reconditioned. Handspring warrants any replaced or repaired product or part, and any hardware upgrade to which Customer is entitled under an agreement between Customer and Handspring, for a period of ninety (90) days from shipment, or through the end of the original warranty, whichever is longer. All products or parts that are replaced become the property of Handspring.

Accessory products, as listed in the applicable Handspring catalogue, are not covered under this Limited Warranty. Handspring shall not be responsible for Customer's software, firmware, information, or memory data contained in, stored on, or integrated with any products returned to Handspring for repair, whether under warranty or not.

SOFTWARE: Handspring warrants to Customer that the Desktop organizer software licensed from it will perform in substantial conformance to their program specifications, for a period of ninety (90) days from the date of original purchase from Handspring. Handspring warrants the media containing software against failure during the warranty period. No updates are provided. Handspring does not provide any warranty for any third party applications software that is licensed to Customer by the third party. Handspring's sole obligation with respect to this express warranty shall be (at Handspring's discretion) to refund the purchase price paid by Customer for any defective software product, or to replace any defective media with software which substantially conforms to applicable Handspring published specifications. Handspring makes no warranty or representation that its software products will meet Customer's requirements or will work in combination with any hardware or applications software products provided by third parties, that the operation of the software products will be uninterrupted or error free, or that all defects in the software products will be corrected.

OBTAINING WARRANTY SERVICE: Customer must contact Handspring within the applicable warranty period to obtain warranty service authorization. Dated proof of original purchase from Handspring will be required. Handspring is not responsible for Customer products or parts received without a warranty service authorization. In the United States, Handspring may ship a replacement product or part prior to receiving the original product or part ("advance exchange"). If advance exchange is not available, then the repaired product or part will be shipped as soon as reasonably possible, which will be no later than thirty (30) days after Handspring receives the original product or part. Repaired or replacement products will be shipped to Customer at Handspring's expense. The repair and replacement process for products or parts in locations outside of the United States will vary depending on Customer's location.

Products or parts shipped by Customer to Handspring must be sent prepaid and packaged appropriately for safe shipment, and it is recommended that they be insured or sent by a method that provides for tracking of the package. When an advance exchange is provided and Customer fails to return the original product or part to Handspring within thirty (30) days from the date the warranty service authorization is issued, Handspring will charge Customer the then current published catalogue price of such product or part.

WARRANTIES EXCLUSIVE: IF THIS PRODUCT DOES NOT OPERATE AS WARRANTED ABOVE, CUSTOMER'S SOLE REMEDY FOR BREACH OF THAT WARRANTY SHALL BE REPLACEMENT OR REPAIR OF THE PRODUCT OR PART OR REFUND OF THE PURCHASE PRICE PAID, AT HANDSPRING'S OPTION. TO THE FULL EXTENT ALLOWED BY LAW, THE FOREGOING WARRANTIES AND REMEDIES ARE EXCLUSIVE AND ARE IN LIEU OF ALL OTHER WARRANTIES, TERMS, OR CONDITIONS, EXPRESS OR IMPLIED, EITHER IN FACT OR BY OPERATION OF LAW, STATUTORY OR OTHERWISE, INCLUDING WARRANTIES, TERMS, OR CONDITIONS OF MERCHANTABILITY, FITNESS FOR A PARTICULAR PURPOSE, SATISFACTORY QUALITY, CORRESPONDENCE WITH DESCRIPTION, AND NON INFRINGEMENT, ALL OF WHICH ARE EXPRESSLY DISCLAIMED BY HANDSPRING AND ITS SUPPLIERS. HANDSPRING NEITHER ASSUMES NOR AUTHORIZES ANY OTHER PERSON TO ASSUME FOR IT ANY OTHER LIABILITY IN CONNECTION WITH THE SALE, INSTALLATION, MAINTENANCE OR USE OF ITS PRODUCTS.

HANDSPRING AND ITS SUPPLIERS SHALL NOT BE LIABLE UNDER THIS WARRANTY IF ITS TESTING AND EXAMINATION DISCLOSE THAT THE ALLEGED DEFECT OR MALFUNCTION IN THE PRODUCT DOES NOT EXIST OR WAS CAUSED BY CUSTOMER'S OR ANY THIRD PERSON'S MISUSE, NEGLIGENCE, IMPROPER INSTALLATION OR TESTING, UNAUTHORIZED ATTEMPTS TO OPEN, REPAIR, OR MODIFY THE PRODUCT, OR ANY OTHER CAUSE BEYOND THE RANGE OF THE INTENDED USE, OR BY ACCIDENT, FIRE, LIGHTNING, OTHER HAZARDS, OR ACTS OF GOD. THIS WARRANTY DOES NOT COVER PHYSICAL DAMAGE TO THE SURFACE OF THE PRODUCT, INCLUDING CRACKS OR SCRATCHES ON THE LCD TOUCHSCREEN OR OUTSIDE CASING. THIS WARRANTY DOES NOT APPLY WHEN THE MALFUNCTION RESULTS FROM THE USE OF THIS PRODUCT IN CONJUNCTION WITH ACCESSORIES, OTHER PRODUCTS, OR ANCILLARY OR PERIPHERAL EQUIPMENT AND HANDSPRING DETERMINES THAT THERE IS NO FAULT WITH THE PRODUCT ITSELF. THIS WARRANTY DOES NOT APPLY TO ANY MALFUNCTION OR FAILURE OF THE PRODUCT OR PART DUE TO ANY COMMUNICATION SERVICE CUSTOMER MAY SUBSCRIBE TO OR USE WITH THE PRODUCT.

LIMITATION OF LIABILITY: TO THE FULL EXTENT ALLOWED BY LAW, HANDSPRING ALSO EXCLUDES FOR ITSELF AND ITS SUPPLIERS ANY LIABILITY, WHETHER BASED IN CONTRACT OR TORT (INCLUDING NEGLIGENCE), FOR INCIDENTAL, CONSEQUENTIAL, INDIRECT, SPECIAL, OR PUNITIVE DAMAGES OF ANY KIND, OR FOR LOSS OF REVENUE OR PROFITS, LOSS OF BUSINESS, LOSS OF INFORMATION OR DATA, OR OTHER FINANCIAL LOSS ARISING OUT OF OR IN CONNECTION WITH THE SALE, INSTALLATION, MAINTENANCE, USE, PERFORMANCE, FAILURE, OR INTERRUPTION OF THIS PRODUCT, EVEN IF HANDSPRING HAS BEEN ADVISED OF THE POSSIBILITY OF SUCH DAMAGES, AND LIMITS ITS LIABILITY TO REPLACEMENT, REPAIR, OR REFUND OF THE PURCHASE PRICE PAID, AT HANDSPRING'S OPTION. THIS DISCLAIMER OF LIABILITY FOR DAMAGES WILL NOT BE AFFECTED IF ANY REMEDY PROVIDED HEREIN SHALL FAIL OF ITS ESSENTIAL PURPOSE.

NOTICE TO CONSUMERS: Some countries, states, or provinces do not allow the exclusion or limitation of implied warranties or the limitation of incidental or consequential damages for certain products supplied to consumers, or the limitation of liability for personal injury, so the above limitations and exclusions may be limited in their application to you. When the implied warranties are not allowed to be excluded in their entirety, they will be limited to the duration of the applicable written warranty. This warranty gives you specific legal rights which may vary depending on local law.

GOVERNING LAW: This Limited Warranty shall be governed by the laws of the State of California, U.S.A. as such laws are applied to agreements entered into and to be performed entirely within California between California residents and by the laws of the United States, excluding its conflicts of laws principles and excluding the United Nations Convention on Contracts for the International Sale of Goods.

Handspring, Inc.

End User Software License Agreement

THIS PRODUCT CONTAINS SOFTWARE, THE USE OF WHICH IS LICENSED BY HANDSPRING, INC. AND ITS SUPPLIERS (COLLECTIVELY, "HANDSPRING"), TO ITS CUSTOMERS FOR THEIR USE ONLY AS SET FORTH BELOW.

SOFTWARE LICENSE: Handspring grants you a nonexclusive license to use the accompanying software program(s) (the "Software") subject to the terms and restrictions set forth in this End User Software License Agreement ("License Agreement"). You are not permitted to lease or rent, distribute or sublicense the Software or to use the Software in a time-sharing arrangement or in any other unauthorized manner. Further, no license is granted to you in the human readable code of the Software (source code). Except as provided below, this License Agreement does not grant you any rights to patents, copyrights, trade secrets, trademarks, or any other rights in respect to the Software.

The Software is licensed to be used solely on or in connection with Handspring products. With respect to the Desktop Software, you may reproduce and provide one (1) copy of such Software for each personal computer on which such Software is used as permitted hereunder. With respect to the Device Software, you may use such Software only on one (1) Handspring product. Otherwise, the Software and supporting documentation may be copied only as essential for backup or archive purposes in support of your use of the Software as permitted hereunder. You must reproduce and include all copyright notices and any other proprietary rights notices appearing on the Software on any copies that you make.

Notwithstanding any other provision of this License Agreement, this License Agreement shall not be deemed to apply to any applications software licensed to you by third parties that is included on the same media as Handspring's Software ("Other Software") if the Other Software provides that the use of the Other Software is subject to the terms and conditions of the third party's license agreement.

Portions of the Software are licensed to Handspring, and from Handspring to you, pursuant to the GNU Library General Public License ("GNU Software"), a copy of which is supplied herewith and incorporated herein in its entirety by this reference. Notwithstanding any other provision of this License Agreement, this License Agreement shall not be deemed to apply to the GNU Software. Source code versions of the GNU Software are available at Handspring's web site, currently located at www.handspring.com.

PAYMENT OF FEES: The effectiveness of the licenses granted hereunder is conditioned on the receipt by Handspring of any applicable fees.

NO ASSIGNMENT; NO REVERSE ENGINEERING: You may transfer the Software and this License Agreement to another party in connection with a transfer of the Handspring product upon which the Software is used, if the other party agrees in writing to accept the terms and conditions of this License Agreement. If you transfer the Software, you must at the same time either transfer all copies of the Software as well as the supporting documentation to the same party or destroy any such materials not transferred. Except as set forth above, you may not transfer or assign the Software or your rights under this License Agreement.

Modification, reverse engineering, reverse compiling, or disassembly of the Software is expressly prohibited. However, if you are a European Union ("EU") resident, information necessary to achieve interoperability of the Software with other programs within the meaning of the EU Directive on the Legal Protection of Computer Programs is available to you from Handspring upon written request.

EXPORT RESTRICTIONS: You agree that you will not export or re-export the Software or accompanying documentation (or any copies thereof) or any products utilizing the Software or such documentation in violation of any applicable laws or regulations of the United States or the country in which you obtained them. The software covered by this License Agreement may contain strong data encryption code which cannot be exported outside of the U.S. or Canada. You agree that you will not export/reexport, either physically or electronically, the encryption software or accompanying documentation without obtaining written authorization from the U.S. Department of Commerce.

UNITED STATES GOVERNMENT LEGEND: If you are acquiring the Software on behalf of any unit or agency of the United States Government, the following provisions apply. The Software constitutes a "commercial item", as that term is defined at Federal Acquisition Regulation (FAR) 2.101 (Oct. 1995), consisting of "commercial computer software" and "commercial computer software documentation", as such terms are used in FAR 12.212 (Sept. 1995), and is provided to the U.S. Government only as commercial software (with "Restricted Rights", if applicable). Use, duplication, or disclosure by the U.S. Government is subject to restrictions set forth in this License Agreement and as provided in DFARS 227.7202-1(a) and 227.7202-3(a) (1995), DFARS 252.227-7013(c)(1)(ii) (OCT 1988), FAR 12.212(a) (1995), FAR 52.227-19, or FAR 52.227-14 (ALT III), as applicable.

TERM AND TERMINATION: This License Agreement is effective until terminated. You may terminate it at any time by destroying the Software and documentation together with all copies and merged portions in any form. It will also terminate immediately if you fail to comply with any term or condition of this License Agreement. Upon such termination you agree to destroy the Software and documentation, together with all copies and merged portions in any form.

GOVERNING LAW: This License Agreement shall be governed by the laws of the State of California as such laws are applied to agreements entered into and to be performed entirely within California between California residents and by the laws of the United States. You agree that the conflicts of laws principles of such laws and the United Nations Convention on Contracts for the International Sale of Goods (1980) are hereby excluded in its entirety from application to this License Agreement.

LIMITED WARRANTY; LIMITATION OF LIABILITY: All warranties and limitations of liability applicable to the Software are as stated on the Limited Warranty or in the product manual accompanying the Software. Such warranties and limitations of liability are incorporated herein in their entirety by this reference.

SEVERABILITY: In the event any provision of this License Agreement is found to be invalid, illegal or unenforceable, the validity, legality and enforceability of any of the remaining provisions shall not in any way be affected or impaired and a valid, legal and enforceable provision of similar intent and economic impact shall be substituted therefor.

ENTIRE AGREEMENT: This License Agreement sets forth the entire understanding and agreement between you and Handspring, supersedes all prior agreements, whether written or oral, with respect to the Software, and may be amended only in a writing signed by both parties.

GNU Library General Public License

Version 2, June 1991

Copyright (C) 1991 Free Software Foundation, Inc.

59 Temple Place - Suite 330, Boston, MA 02111-1307, USA.

Everyone is permitted to copy and distribute verbatim copies of this license document, but changing it is not allowed.

[This is the first released version of the library GPL. It is numbered 2 because it goes with version 2 of the ordinary GPL.]

PREAMBLE: The licenses for most software are designed to take away your freedom to share and change it. By contrast, the GNU General Public Licenses are intended to guarantee your freedom to share and change free software—to make sure the software is free for all its users.

This license, the Library General Public License, applies to some specially designated Free Software Foundation software, and to any other libraries whose authors decide to use it. You can use it for your libraries, too.

When we speak of free software, we are referring to freedom, not price. Our General Public Licenses are designed to make sure that you have the freedom to distribute copies of free software (and charge for this service if you wish), that you receive source code or can get it if you want it, that you can change the software or use pieces of it in new free programs; and that you know you can do these things.

To protect your rights, we need to make restrictions that forbid anyone to deny you these rights or to ask you to surrender the rights. These restrictions translate to certain responsibilities for you if you distribute copies of the library, or if you modify it. For example, if you distribute copies of the library, whether gratis or for a fee, you must give the recipients all the rights that we gave you. You must make sure that they, too, receive or can get the source code. If you link a program with the library, you must provide complete object files to the recipients so that they can relink them with the library, after making changes to the library and recompiling it. And you must show them these terms so they know their rights.

Our method of protecting your rights has two steps: (1) copyright the library, and (2) offer you this license which gives you legal permission to copy, distribute and/or modify the library.

Also, for each distributor's protection, we want to make certain that everyone understands that there is no warranty for this free library. If the library is modified by someone else and passed on, we want its recipients to know that what they have is not the original version, so that any problems introduced by others will not reflect on the original authors' reputations.

Finally, any free program is threatened constantly by software patents. We wish to avoid the danger that companies distributing free software will individually obtain patent licenses, thus in effect transforming the program into proprietary software. To prevent this, we have made it clear that any patent must be licensed for everyone's free use or not licensed at all.

Most GNU software, including some libraries, is covered by the ordinary GNU General Public License, which was designed for utility programs. This license, the GNU Library General Public License, applies to certain designated libraries. This license is quite different from the ordinary one; be sure to read it in full, and don't assume that anything in it is the same as in the ordinary license.

The reason we have a separate public license for some libraries is that they blur the distinction we usually make between modifying or adding to a program and simply using it. Linking a program with a library, without changing the library, is in some sense simply using the library, and is analogous to running a utility program or application program. However, in a textual and legal sense, the linked executable is a combined work, a derivative of the original library, and the ordinary General Public License treats it as such.

Because of this blurred distinction, using the ordinary General Public License for libraries did not effectively promote software sharing, because most developers did not use the libraries. We concluded that weaker conditions might promote sharing better.

However, unrestricted linking of non-free programs would deprive the users of those programs of all benefit from the free status of the libraries themselves. This Library General Public License is intended to permit developers of non-free programs to use free libraries, while preserving your freedom as a user of such programs to change the free libraries that are incorporated in them. (We have not seen how to achieve this as regards changes in header files, but we have achieved it as regards changes in the actual functions of the Library.) The hope is that this will lead to faster development of free libraries.

The precise terms and conditions for copying, distribution and modification follow. Pay close attention to the difference between a "work based on the library" and a "work that uses the library". The former contains code derived from the library, while the latter only works together with the library.

Note that it is possible for a library to be covered by the ordinary General Public License rather than by this special one.

Terms and Conditions for Copying, Distribution and Modification

0. This License Agreement applies to any software library which contains a notice placed by the copyright holder or other authorized party saying it may be distributed under the terms of this Library General Public License (also called "this License"). Each licensee is addressed as "you".

A "library" means a collection of software functions and/or data prepared so as to be conveniently linked with application programs (which use some of those functions and data) to form executables.

The "Library", below, refers to any such software library or work which has been distributed under these terms. A "work based on the Library" means either the Library or any derivative work under copyright law: that is to say, a work containing the Library or a portion of it, either verbatim or with modifications and/or translated straightforwardly into another language. (Hereinafter, translation is included without limitation in the term "modification".)

"Source code" for a work means the preferred form of the work for making modifications to it. For a library, complete source code means all the source code for all modules it contains, plus any associated interface definition files, plus the scripts used to control compilation and installation of the library.

Activities other than copying, distribution and modification are not covered by this License; they are outside its scope. The act of running a program using the Library is not restricted, and output from such a program is covered only if its contents constitute a work based on the Library (independent of the use of the Library in a tool for writing it). Whether that is true depends on what the Library does and what the program that uses the Library does.

1. You may copy and distribute verbatim copies of the Library's complete source code as you receive it, in any medium, provided that you conspicuously and appropriately publish on each copy an appropriate copyright notice and disclaimer of warranty; keep intact all the notices that refer to this License and to the absence of any warranty; and distribute a copy of this License along with the Library.

You may charge a fee for the physical act of transferring a copy, and you may at your option offer warranty protection in exchange for a fee.

2. You may modify your copy or copies of the Library or any portion of it, thus forming a work based on the Library, and copy and distribute such modifications or work under the terms of Section 1 above, provided that you also meet all of these conditions:

- a) The modified work must itself be a software library.
- b) You must cause the files modified to carry prominent notices stating that you changed the files and the date of any change.
- c) You must cause the whole of the work to be licensed at no charge to all third parties under the terms of this License.
- d) If a facility in the modified Library refers to a function or a table of data to be supplied by an application program that uses the facility, other than as an argument passed when the facility is invoked, then you must make a good faith effort to ensure that, in the event an application does not supply such function or table, the facility still operates, and performs whatever part of its purpose remains meaningful. (For example, a function in a library to compute square roots has a purpose that is entirely well-defined independent of the application. Therefore, Subsection 2d requires that any application-supplied function or table used by this function must be optional: if the application does not supply it, the square root function must still compute square roots.)

These requirements apply to the modified work as a whole. If identifiable sections of that work are not derived from the Library, and can be reasonably considered independent and separate works in themselves, then this License, and its terms, do not apply to those sections when you distribute them as separate works. But when you distribute the same sections as part of a whole which is a work based on the Library, the distribution of the whole must be on the terms of this License, whose permissions for other licensees extend to the entire whole, and thus to each and every part regardless of who wrote it.

Thus, it is not the intent of this section to claim rights or contest your rights to work written entirely by you; rather, the intent is to exercise the right to control the distribution of derivative or collective works based on the Library.

In addition, mere aggregation of another work not based on the Library with the Library (or with a work based on the Library) on a volume of a storage or distribution medium does not bring the other work under the scope of this License.

3. You may opt to apply the terms of the ordinary GNU General Public License instead of this License to a given copy of the Library. To do this, you must alter all the notices that refer to this License, so that they refer to the ordinary GNU General Public License, version 2, instead of to this License. (If a newer version than version 2 of the ordinary GNU General Public License has appeared, then you can specify that version instead if you wish.) Do not make any other change in these notices.

Once this change is made in a given copy, it is irreversible for that copy, so the ordinary GNU General Public License applies to all subsequent copies and derivative works made from that copy.

This option is useful when you wish to copy part of the code of the Library into a program that is not a library.

4. You may copy and distribute the Library (or a portion or derivative of it, under Section 2) in object code or executable form under the terms of Sections 1 and 2 above provided that you accompany it with the complete corresponding machine-readable source code, which must be distributed under the terms of Sections 1 and 2 above on a medium customarily used for software interchange.

If distribution of object code is made by offering access to copy from a designated place, then offering equivalent access to copy the source code from the same place satisfies the requirement to distribute the source code, even though third parties are not compelled to copy the source along with the object code.

5. A program that contains no derivative of any portion of the Library, but is designed to work with the Library by being compiled or linked with it, is called a “work that uses the Library”. Such a work, in isolation, is not a derivative work of the Library, and therefore falls outside the scope of this License.

However, linking a “work that uses the Library” with the Library creates an executable that is a derivative of the Library (because it contains portions of the Library), rather than a “work that uses the library”. The executable is therefore covered by this License. Section 6 states terms for distribution of such executables.

When a “work that uses the Library” uses material from a header file that is part of the Library, the object code for the work may be a derivative work of the Library even though the source code is not. Whether this is true is especially significant if the work can be linked without the Library, or if the work is itself a library. The threshold for this to be true is not precisely defined by law.

If such an object file uses only numerical parameters, data structure layouts and accessors, and small macros and small inline functions (ten lines or less in length), then the use of the object file is unrestricted, regardless of whether it is legally a derivative work. (Executables containing this object code plus portions of the Library will still fall under Section 6.)

Otherwise, if the work is a derivative of the Library, you may distribute the object code for the work under the terms of Section 6. Any executables containing that work also fall under Section 6, whether or not they are linked directly with the Library itself.

6. As an exception to the Sections above, you may also compile or link a “work that uses the Library” with the Library to produce a work containing portions of the Library, and distribute that work under terms of your choice, provided that the terms permit modification of the work for the customer's own use and reverse engineering for debugging such modifications.

You must give prominent notice with each copy of the work that the Library is used in it and that the Library and its use are covered by this License. You must supply a copy of this License. If the work during execution displays copyright notices, you must include the copyright notice for the Library among them, as well as a reference directing the user to the copy of this License. Also, you must do one of these things:

- a) Accompany the work with the complete corresponding machine-readable source code for the Library including whatever changes were used in the work (which must be distributed under Sections 1 and 2 above); and, if the work is an executable linked with the Library, with the complete machine-readable “work that uses the Library”, as object code and/or source code, so that the user can modify the Library and then relink to produce a modified executable containing the modified Library. (It is understood that the user who changes the contents of definitions files in the Library will not necessarily be able to recompile the application to use the modified definitions.)
- b) Accompany the work with a written offer, valid for at least three years, to give the same user the materials specified in Subsection 6a, above, for a charge no more than the cost of performing this distribution.

c) If distribution of the work is made by offering access to copy from a designated place, offer equivalent access to copy the above specified materials from the same place.

d) Verify that the user has already received a copy of these materials or that you have already sent this user a copy.

For an executable, the required form of the “work that uses the Library” must include any data and utility programs needed for reproducing the executable from it. However, as a special exception, the source code distributed need not include anything that is normally distributed (in either source or binary form) with the major components (compiler, kernel, and so on) of the operating system on which the executable runs, unless that component itself accompanies the executable.

It may happen that this requirement contradicts the license restrictions of other proprietary libraries that do not normally accompany the operating system. Such a contradiction means you cannot use both them and the Library together in an executable that you distribute.

7. You may place library facilities that are a work based on the Library side-by-side in a single library together with other library facilities not covered by this License, and distribute such a combined library, provided that the separate distribution of the work based on the Library and of the other library facilities is otherwise permitted, and provided that you do these two things:
 - a) Accompany the combined library with a copy of the same work based on the Library, uncombined with any other library facilities. This must be distributed under the terms of the Sections above.
 - b) Give prominent notice with the combined library of the fact that part of it is a work based on the Library, and explaining where to find the accompanying uncombined form of the same work.
8. You may not copy, modify, sublicense, link with, or distribute the Library except as expressly provided under this License. Any attempt otherwise to copy, modify, sublicense, link with, or distribute the Library is void, and will automatically terminate your rights under this License. However, parties who have received copies, or rights, from you under this License will not have their licenses terminated so long as such parties remain in full compliance.
9. You are not required to accept this License, since you have not signed it. However, nothing else grants you permission to modify or distribute the Library or its derivative works. These actions are prohibited by law if you do not accept this License. Therefore, by modifying or distributing the Library (or any work based on the Library), you indicate your acceptance of this License to do so, and all its terms and conditions for copying, distributing or modifying the Library or works based on it.
10. Each time you redistribute the Library (or any work based on the Library), the recipient automatically receives a license from the original licensor to copy, distribute, link with or modify the Library subject to these terms and conditions. You may not impose any further restrictions on the recipients' exercise of the rights granted herein. You are not responsible for enforcing compliance by third parties to this License.
11. If, as a consequence of a court judgment or allegation of patent infringement or for any other reason (not limited to patent issues), conditions are imposed on you (whether by court order, agreement or otherwise) that contradict the conditions of this License, they do not excuse you from the conditions of this License. If you cannot distribute so as to satisfy simultaneously your obligations under this License and any other pertinent obligations, then as a consequence you may not distribute the Library at all. For example, if a patent license would not permit royalty-free redistribution of the Library by all those who receive copies directly or indirectly

through you, then the only way you could satisfy both it and this License would be to refrain entirely from distribution of the Library.

If any portion of this section is held invalid or unenforceable under any particular circumstance, the balance of the section is intended to apply, and the section as a whole is intended to apply in other circumstances.

It is not the purpose of this section to induce you to infringe any patents or other property right claims or to contest validity of any such claims; this section has the sole purpose of protecting the integrity of the free software distribution system which is implemented by public license practices. Many people have made generous contributions to the wide range of software distributed through that system in reliance on consistent application of that system; it is up to the author/donor to decide if he or she is willing to distribute software through any other system and a licensee cannot impose that choice.

This section is intended to make thoroughly clear what is believed to be a consequence of the rest of this License.

12. If the distribution and/or use of the Library is restricted in certain countries either by patents or by copyrighted interfaces, the original copyright holder who places the Library under this License may add an explicit geographical distribution limitation excluding those countries, so that distribution is permitted only in or among countries not thus excluded. In such case, this License incorporates the limitation as if written in the body of this License.
13. The Free Software Foundation may publish revised and/or new versions of the Library General Public License from time to time. Such new versions will be similar in spirit to the present version, but may differ in detail to address new problems or concerns.

Each version is given a distinguishing version number. If the Library specifies a version number of this License which applies to it and "any later version", you have the option of following the terms and conditions either of that version or of any later version published by the Free Software Foundation. If the Library does not specify a license version number, you may choose any version ever published by the Free Software Foundation.

14. If you wish to incorporate parts of the Library into other free programs whose distribution conditions are incompatible with these, write to the author to ask for permission. For software which is copyrighted by the Free Software Foundation, write to the Free Software Foundation; we sometimes make exceptions for this. Our decision will be guided by the two goals of preserving the free status of all derivatives of our free software and of promoting the sharing and reuse of software generally.

NO WARRANTY

15. BECAUSE THE LIBRARY IS LICENSED FREE OF CHARGE, THERE IS NO WARRANTY FOR THE LIBRARY, TO THE EXTENT PERMITTED BY APPLICABLE LAW. EXCEPT WHEN OTHERWISE STATED IN WRITING THE COPYRIGHT HOLDERS AND/OR OTHER PARTIES PROVIDE THE LIBRARY "AS IS" WITHOUT WARRANTY OF ANY KIND, EITHER EXPRESSED OR IMPLIED, INCLUDING, BUT NOT LIMITED TO, THE IMPLIED WARRANTIES OF MERCHANTABILITY AND FITNESS FOR A PARTICULAR PURPOSE. THE ENTIRE RISK AS TO THE QUALITY AND PERFORMANCE OF THE LIBRARY IS WITH YOU. SHOULD THE LIBRARY PROVE DEFECTIVE, YOU ASSUME THE COST OF ALL NECESSARY SERVICING, REPAIR OR CORRECTION.

16. IN NO EVENT UNLESS REQUIRED BY APPLICABLE LAW OR AGREED TO IN WRITING WILL ANY COPYRIGHT HOLDER, OR ANY OTHER PARTY WHO MAY MODIFY AND/OR REDISTRIBUTE THE LIBRARY AS PERMITTED ABOVE, BE LIABLE TO YOU FOR DAMAGES, INCLUDING ANY GENERAL, SPECIAL, INCIDENTAL OR CONSEQUENTIAL DAMAGES ARISING OUT OF THE USE OR INABILITY TO USE THE LIBRARY (INCLUDING BUT NOT LIMITED TO LOSS OF DATA OR DATA BEING RENDERED INACCURATE OR LOSSES SUSTAINED BY YOU OR THIRD PARTIES OR A FAILURE OF THE LIBRARY TO OPERATE WITH ANY OTHER SOFTWARE), EVEN IF SUCH HOLDER OR OTHER PARTY HAS BEEN ADVISED OF THE POSSIBILITY OF SUCH DAMAGES.

END OF TERMS AND CONDITIONS

How to Apply These Terms to Your New Library

If you develop a new library, and you want it to be of the greatest possible use to the public, we recommend making it free software that everyone can redistribute and change. You can do so by permitting redistribution under these terms (or, alternatively, under the terms of the ordinary General Public License).

To apply these terms, attach the following notices to the library. It is safest to attach them to the start of each source file to most effectively convey the exclusion of warranty; and each file should have at least the "copyright" line and a pointer to where the full notice is found.

One line to give the library's name and an idea of what it does.
Copyright (C) year name of author

This library is free software; you can redistribute it and/or modify it under the terms of the GNU Library General Public License as published by the Free Software Foundation; either version 2 of the License, or (at your option) any later version.

This library is distributed in the hope that it will be useful, but WITHOUT ANY WARRANTY; without even the implied warranty of MERCHANTABILITY or FITNESS FOR A PARTICULAR PURPOSE. See the GNU Library General Public License for more details.

You should have received a copy of the GNU Library General Public License along with this library; if not, write to the Free Software Foundation, Inc., 59 Temple Place - Suite 330, Boston, MA 02111-1307, USA.

Also add information on how to contact you by electronic and paper mail. You should also get your employer (if you work as a programmer) or your school, if any, to sign a "copyright disclaimer" for the library, if necessary. Here is a sample; alter the names:

Yoyodyne, Inc., hereby disclaims all copyright interest in the library `Frob' (a library for tweaking knobs) written by James Random Hacker.

Signature of Ty Coon, 1 April 1990
Ty Coon, President of Vice

That's all there is to it!

FCC Statement

This device complies with part 15 of the FCC rules. Operation is subject to the following two conditions: (1) This device may not cause harmful interference, and (2) this device must accept any interference received, including interference that may cause undesired operation.

Note: This equipment has been tested and found to comply with the limits for a Class B digital device, pursuant to Part 15 of the FCC rules. These limits are designed to provide reasonable protection against harmful interference in a residential installation. This equipment generates, uses, and can radiate radio frequency energy and, if not installed and used in accordance with the instructions, may cause harmful interference to radio communications. However, there is no guarantee that interference will not occur in a particular installation. If this equipment does cause harmful interference to radio or television reception, which can be determined by turning the equipment off and on, the user is encouraged to try to correct the interference by one or more of the following measures:

- Reorient or relocate the receiving antenna.
- Increase the separation between the equipment and receiver.
- Connect the equipment into an outlet on a circuit different from that to which the receiver is connected.
- Consult the dealer or an experienced radio/TV technician for help.

The use of shielded I/O cables is required when connecting this equipment to any and all optional peripheral or host devices. Failure to do so may violate FCC rules.

Caution: Changes or modifications not covered in this manual must be approved in writing by the manufacturer's Regulatory Engineering Department. Changes or modifications made without written approval may void the user's authority to operate this equipment.



Canadian RFI Statement

This Class B digital apparatus meets all requirements of the Canadian Interference-Causing Equipment Regulations.

Cet appareil numérique de la classe B respecte toutes les exigences du Règlement sur le matériel brouilleur du Canada.

Acknowledgments

We would like to thank the following developers whose contributions were an integral part of the Handspring product:

- **C.E. Steuart Dewar**
Pimlico Software, Inc.
www.gorilla-haven.org/pimlico
- **Darren Beck**
Code City
www.codacity.com.au
- **Rick Huebner**
www.probe.net/~rhuebner/index.html

Index

A

Accented characters

- Graffiti writing 32
- onscreen keyboard 34

Add-on applications 40–43

Address Book

- *If Found Call* entry 112
- adding custom fields 115
- business card for beaming 167
- categorizing records 66
- conduit for synchronizing 174
- creating records 59, 111–112
- deleting records 62
- displaying category 115
- displaying data in the Address List 114
- finding records 70
- fonts 78
- menus 114
- notes for records 77
- opening 52
- overview 52
- pressing button to beam information 169
- private records 75
- sorting records 74

Alarm

- preset 94, 106
- reminder 106
- setting 84
- sound 94, 106, 194, 220
- for untimed events 85

Alphabet

- Graffiti writing 28
- onscreen keyboard 12, 18

Anniversaries. *See* Repeating events

Application buttons 6, 13, 51, 52, 53, 54, 169, 186

Applications

- Address Book 52
- beaming 167–168
- Calculator 55

categories 37–38

CityTime 56

Date Book 50

Expense 57

font style 78

installing 40–42

Memo Pad 54

opening 14

preferences for 39

removing 42

security 44

size in kilobytes 229

To Do List 53

version of 229

viewing as icons 38

viewing as list 38

See also Add-on applications

Applications Launcher 13–14, 37–39

Appointments. *See* Date Book

Archive files

saving deleted records 62

saving purged records 63

Automatic fill, in Expense 144

Auto-off delay 194

Autotext. *See* Graffiti ShortCuts

B

Backlight 7, 187

Backup. *See* HotSync

Batteries

battery door 9

installing 10

Battery

conserving power 194

gauge 13

BCC (blind carbon copy) 152

Beaming

See also Infrared

Beaming information 167–169

location of IR port 9

pen stroke to activate 187

problems with 227

Birthdays. *See* Repeating events

Bold font for text 78

Brightness Control 7

Business card for beaming 167

Buttons preferences 186

C

Calculator

- Advanced mode 124
- Area view 132
- Basic mode 123
- buttons explained 123–124,
125–133
- Finance view 127
- Length view 131
- Logic view 129
- Math view 125
- memory 123
- menus 135
- opening 55, 123
- overview 55
- recent calculations 55, 124
- selecting mode 123
- Statistics view 129
- Trigonometry view 126
- Volume view 133
- Weight/Temp view 130

Calibration 11, 192, 221

Call Waiting, disabling 181, 200

Calling card, using in phone settings 181, 200

Capital letters (Graffiti writing) 29

Caring for the handheld 213

Categories

- application 37–38
- assigning records to 66–67
- beaming 167–168
- creating 68
- default 66
- displaying 67, 115, 222
- folders for e-mail 158
- merging 69
- renaming 69
- using in Applications
Launcher 38

Chain calculations 124

Characters, Graffiti 25

Check boxes 12

CityTime

- adding cities 137

home city 136

menus 138

opening 56

overview 136

remote cities 137

Clearing Calculator entries 123, 125

COM port. *See* USB, port *and* Serial port

Combining categories 69

Command buttons 12

Command equivalents (Graffiti writing) 15

Compressing Day view 93, 105

Computer keyboard, entering data with 19

Conduits

for connecting to PIMs 24

for modem HotSync

operations 181

for synchronizing

applications 223,
174–175

See also HotSync

Confirming e-mail 154

Conflicting events 91

Connecting

service templates 202

to server or ISP 201

Contact information. *See* Address Book

Continuous events

changing 86

deleting from Date Book 62, 86

scheduling 85

Contrast Control 7

Copying text 61

Country default setting 193

Cover 8

Cradle

connecting to computer 9, 22

for local HotSync operations 64,
65

serial 22

USB 23

Creating

Address Book entries 111–112

categories 37–38, 68

- currency symbols 142
 - custom fields in Address Book 115
 - Date Book events 80
 - e-mail 148–150
 - Expense items 139
 - memos 121
 - notes for records 77
 - records 59
 - To Do List items 116
 - Currency
 - default 144
 - defining 142
 - for Expense items 141, 142
 - Current date 21, 222
 - Current time 13
 - displaying in Date Book 88
 - setting 21
 - Customizing
 - categories 69
 - currencies and symbols 142
 - fields in Address Book 115
 - HotSync settings 174
 - See also* Preferences
 - Cutting text 61
 - Cycling through views 51, 52, 53, 54
- D**
- Daily
 - calendar 80–84
 - events. *See* Repeating events
 - Journal 100
 - Data
 - entry. *See* Entering data
 - transfer. *See* HotSync
 - transmitting to other handhelds.
 - See* Beaming information
 - Date Book
 - adding Address Book data to records 72–73
 - alarm 84
 - changing event time 84
 - changing event to untimed 83
 - changing repeating events 86
 - conduit for synchronizing 174
 - conflicting events 91
 - continuous events 85–87
 - creating records 59, 80–84
 - Day view 88
 - deleting records 62
 - deleting repeating events 86
 - display options 93
 - end time for Day view 94, 104
 - fonts 78
 - menus 92
 - Month view 90
 - notes for records 77
 - opening 50
 - overview 50
 - private records 75
 - purging records 63
 - repeating events 62, 85–87
 - scheduling events 80–84
 - selecting dates 82
 - selecting default 102
 - start time for Day view 94, 104
 - Sunday or Monday to start week 193
 - switching views 88
 - untimed events 80, 83
 - Week view 88, 193, 222
 - Date Book Plus
 - Daily Journal 100
 - Event tracking 100
 - floating events 97
 - List View 97
 - menus 102
 - opening 51
 - overview 51
 - templates 101
 - To Do List items 99
 - Week View with Text 95
 - Year View 96
 - Dates
 - Expense item 140
 - setting current 21, 222
 - showing in Mail list 159
 - To Do List record due 118
 - Day (Date Book view) 80, 93, 105
 - Decimal point 193
 - Default
 - categories 66

- currency in Expense 144
- settings. *See* Preferences
- Deleted
 - data, saving in archive files 62
 - e-mail, recovering 157
- Deleting
 - applications 40, 42
 - Desktop software 43
 - e-mail 157
 - Graffiti characters 27
 - passwords 45
 - records 62
 - service templates 207
 - text 61
 - See also* Purging records
- Delivering e-mail 151, 154
- Desktop E-Mail application
 - managing 145–166
 - support of Mail features 151
- Desktop software 22–23
 - configuring mail 146
 - for entering data 19
 - removing 43
 - saving deleted data to an archive file 62
 - system requirements 4
 - upgrading 4
 - See also* PIM
- Digitizer 11, 192, 221
- Display, contrast (brightness) control 7
- DNS (Domain Naming System) 204
- Docking station. *See* Cradle
- Double-booked events 91
- Draft e-mail 155
- Dragging
 - memos into other applications 54
 - stylus to activate features 187
 - using the stylus 11

E

- Editing
 - records 60–61
 - unsent e-mail 154
- E-mail addresses

- in Address Book 113, 114
- looking up 150–151
- E-mail items. *See* Mail
- Entering data 17–20
 - importing from other applications 35–36
 - problems with 221
 - using Graffiti writing 25–34
 - using the computer keyboard 35
 - using the onscreen keyboard 34
- Entries. *See* Address Book
- Events. *See* Date Book
- Exchanging data. *See* HotSync
- Exclamation marks in To Do List 120
- Expansion slot 24
- Expense

- adding Address Book data to records 73
- categorizing records 66
- creating records 59, 139
- currency 141, 142, 144
- date of item 140
- defining new currency 142
- deleting records 62
- menus 144
- notes for records 77
- opening 57
- overview 57
- purging records 63
- receipt details 140
- sorting records 74
- type 141, 144
- vendor 141

F

- FCC Statement 245
- Filing e-mail 156
- Filters for e-mail 161–165
- Finding
 - applications, using Graffiti writing 14
 - e-mail addresses 150–151
 - information in
 - applications 69–73
 - phone numbers 72–73
 - using the Find application 71

Floating events 97
Folders for e-mail 158
Fonts 78
Formats preferences 192
Frozen handheld 220

G

Games 42, 194
General preferences
 alarm sounds 194
 auto-off delay 194
 system sounds 194
Glossary. *See* Graffiti ShortCuts
Graffiti
 accented characters 32
 alphabet 25, 28
 basic concepts 25
 capital letters 29
 Command stroke 16
 defined 17
 Giraffe game for practicing 42
 how to write characters 26
 menu commands 15
 moving the cursor 33
 numbers 29
 online Help 61, 186
 problems using 221
 punctuation marks 30
 ShortCuts for entering data 33,
 210–211
 symbols 31
 tips 27
 writing 25–34
 writing area 6, 26

H

Handheld
 battery door 9
 battery installation 10
 contrast control 7
 cover 8
Hard reset 216
Header information (e-mail) 147, 149
Help
 Graffiti 61

 online tips 16
Hiding
 records 75
 See also Private records
High Priority e-mail filter 164
HotSync
 buttons preferences 188
 conduits for synchronizing
 applications 174–175
 customizing 174
 defined 64
 first-time operation 64–66,
 182–183
 for managing desktop
 E-Mail 146
 HotSync Manager 64
 IR operation 175–178
 local operation 65, 224
 modem operation 173, 178–182,
 225–226
 operations using IR
 port 175–178
 options for filtering
 e-mail 160–165
 problems with 223–226
 setting options 171–173
 for synchronizing data 22

I

Icons
 alarm 84
 application 12, 38
 note 77
 online Tips 16
 onscreen 221
 repeating event 86
Idle timeout of ISP or server
 connection 203
Ignoring e-mail. *See* Filters for e-mail
Importing data 20, 35–36
Inbox 158
Infrared
 HotSync operations 175–178
 port 175
 requirements for computer 175
Infrared port. *See* IR port

Installing

- applications 40–42
- batteries 10
- conduit to install
 - applications 174
- Desktop software 23
- Mail. *See* Mail, desktop configuration

International characters

- Graffiti writing 32
- onscreen keyboard 34

IP address 202, 204

IR port 9

See also Beaming information

IR. *See* Infrared

Items. *See* To Do List or Expense

K

Keyboard

- computer 35
- onscreen 12, 34, 187

L

Letters

- font style 78
- Graffiti 25, 28
- onscreen keyboard 34

Linking

- with desktop software. *See* HotSync

List (Date Book Plus view) 97

List, in Applications Launcher 38

Locking

- handheld with a password 46, 187, 209
- records. *See* Security

Login scripts 205, 231

- Looking up Address Book data
 - to add to other records 72–73
 - scrolling in Address List 70
 - to add to e-mail
 - addresses 150–151

Looking up. *See* Finding

Lost handheld, contact for 112

Lost records 222

M

Mail

- address lookup 150–151
- attachments 161
- BCC (blind carbon copy) 151, 152
- closing 147
- confirm delivery 151, 154
- confirm read 151, 154
- creating 148–150
- deleting e-mail 157
- draft e-mail 155
- editing unsent e-mail 154
- filing e-mail 156
- filtering options 160–165
- folders 158
- menus 166
- opening 146
- overview 145–146
- priority of delivery 151, 152
- purging deleted e-mail 158
- recovering deleted 157
- replying to e-mail 149
- sending 154
- showing dates 159
- signature 151, 153–154
- sorting 159
- synchronizing 146
- truncating 165
- viewing e-mail 146

Main applications 13

Maintenance information 213

Meetings. *See* Date Book

Memo Pad

- adding Address Book data to records 72–73
- categorizing records 66
- conduit for synchronizing 174
- creating records 59, 121
- deleting records 62
- dragging memos into other applications 54
- fonts 78
- menus 122
- opening 54
- overview 54
- private records 75

- reviewing memos 121
- sorting records 74, 222
- See also* Notes
- Memory
 - amount of free 229
 - for beaming 227
 - Calculator 123
 - regaining 63
- Memos. *See* Memo Pad
- Menus 14–16, 221
 - Address Book 114
 - choosing 15
 - command equivalents (Graffiti writing) 15
 - Date Book 92, 102
 - Edit menu 60–61
 - Expense 144
 - Mail 166
 - Memo Pad 122, 135, 138
 - menu bar 12, 14
 - Network Preferences 208
 - To Do List 120
- Modem
 - HotSync operations via 178–182, 225–226
- Modem port 179
- Monday, to start week 193
- Month (Date Book view) 90, 93
- Moving
 - Date Book events 84
 - the cursor (Graffiti writing) 33
- Multi-day events. *See* Repeating events

N

- Network
 - connecting 201
 - connection type 203
 - idle timeout 203
 - login scripts 205
 - password 197
 - phone settings 198
 - preferences 198–209
 - primary DNS 204
 - secondary DNS 204
 - selecting service 195

- TCP/IP 195
- user name 196

Notes

- attaching to records 77
- See also* Memo Pad

Numbers

- decimal point and thousands separator 193
- Graffiti writing 29
- onscreen keyboard 12, 18, 34

O

- Onscreen keyboard 18, 34, 61
 - pen stroke to open 187

Opening

- Address Book 52
- applications 13–14
- Calculator 55, 123
- CityTime 56
- Date Book 50
- Date Book Plus 51
- Expense 57
- Mail 146
- Memo Pad 54
- To Do List 53

- Outbox 154, 158
- Overlapping events 91
- Owner preferences 209

P

- Palm Desktop software. *See* Desktop software

- Passwords 44–47

- changing 45
- creating 44
- deleting 45
- for network 197
- forgotten 47, 228

- Pasting text 61

- Payment, Expense item 141

- Pen. *See* Stylus

- Personal information managers. *See*

- PIM

- Phone Lookup 72–73

- Phone numbers

- selecting for Address List 114
- selecting types 113
- Phone settings for ISP or dial-in server 198–201
- Pick lists 12
- PIM (personal information manager)
 - using with handheld 24
- Pointer. *See* Stylus
- Ports
 - IR on handheld 175
- Ports. *See* USB, port *and* Serial port
- Power button 7
- PPP 202
- PRC (application file extension) 40
- Preferences 20
 - Buttons 186
 - choosing 39
 - Digitizer 192
 - Formats 192
 - General 193
 - HotSync buttons 188
 - Network 198–209
 - Owner 209
 - ShortCuts 210
- Primary DNS 204
- Printing
 - records from applications 22
- Prioritizing To Do List records 116, 120
- Priority of delivery (e-mail) 152
- Private records
 - displaying and creating 75, 222
 - lost with forgotten password 47
 - See also* Security
- Profiles 182
- Punctuation marks
 - Graffiti writing 30
 - onscreen keyboard 34
- Purging
 - deleted e-mail 158
 - records 63
 - See also* Deleting

R

- Range of times in Day view 94, 104
- Reading e-mail on handheld 146

- Receipts, recording in Expense 140
- Receiving data. *See* Beaming information

Records

- Address Book 111
- beaming 167–168
- choosing categories 66
- creating 59
- Date Book 80
- defined 59
- deleting 62, 86
- displaying a category of 67
- editing 60–61
- Expense 139
- fonts 78
- hiding private 44, 75
- lost 222
- Memo Pad 121
- notes for 77
- number of 229
- private 75
- purging 63
- sorting 74
- To Do List 116

Recovering

- deleted e-mail 157
- filed mail 157

Recurring events

- deleting 62
- scheduling 85

Reminder. *See* Alarm

Removing

- applications 42
- Desktop software 43

Renaming categories 69

Repeating events

- deleting from Date Book 62
- scheduling 85

Replying to e-mail 149

Rescheduling events 84

Resetting handheld

- hard reset 216
- location of reset button 9, 215
- soft reset 215

Retrieving e-mail. *See* Filters for e-mail

S

Saving

- data 37, 59, 62
- draft e-mail 155

Scheduling events 80–84

Screen

- backlight 7
- blank 220
- brightness control 7
- calibrating 11, 192
- caring for 213
- contrast control 7
- touching 6

Scroll bar 13

Scroll buttons 6

Searching. *See* Finding

Secondary DNS 204

Security 44–47

- changing password 45
- deleting password 45
- displaying owner's name 209
- forgotten password 47
- locking the handheld 46
- private records 75

Selecting

- date for event 82
- e-mail to be synchronized. *See*
Filters for e-mail
- phone numbers in Address
Book 113
- text 60, 61

Sending

- data. *See* Beaming information
- e-mail 148–150, 154

Serial port 9, 178, 225, 226

Service templates 202, 207

Service, selecting for network 195

Settings. *See* Preferences

ShortCuts

- backing up 174
- managing 210–211
- menu commands 15
- predefined 34
- using 33

Showing dates in Mail list 159

Signature for e-mail 153–154

Soft reset 215

Sorting

- applications 38
- e-mail items 159
- records 74, 222

Sounds. *See* Alarm and System sounds

Springboard expansion module 9, 24

Stand. *See* Cradle

Standing Meetings. *See* Repeating events

Starting applications 14

Storing e-mail 156

Stylus

- dragging with 11
- full-screen pen stroke 186–187
- pen stroke to activate a
feature 186
- tapping with 11
- writing with 9, 25

Sunday, to start week 193

Symbols

- for currency 142
- in Graffiti writing 31

Synchronizing data. *See* HotSync

System conduit 174

System requirements for Desktop software 4

System sounds 194

T

Tapping 11, 221

Task. *See* To Do List

TCP/IP 195, 208

Technical Support 229

Templates

- for Date Book Plus 101

Text

- copying 61
- cutting 61
- entry. *See* Entering data
- finding 69
- fonts for 78
- importing data from files 35
- selecting all 61

Thousands separator 193

Time

- alarm setting 84
- format 193
- setting current 21
- setting event 80
- start and end for Date Book Day
 - view 94, 104
- Time bars in Date Book 93, 105
- Time stamps 100
- Tips, online 16
- To Do List
 - adding Address Book data to records 72–73
 - categorizing records 66, 107, 120
 - checking off items 99, 117
 - completed items 119
 - completion date 119
 - conduit for synchronizing 174
 - creating items in Date Book Plus 99
 - creating records 59, 116
 - deleting records 62
 - due date 118, 119, 120
 - fonts 78
 - menus 120
 - notes for records 77
 - opening 53
 - overview 53
 - prioritizing records 116, 120
 - private records 75
 - purging records 63, 119
 - sorting records 74
 - viewing items in Date Book Plus 95, 97
- Today. *See* Current date
- Tracking events 100
- Transferring data. *See* HotSync
- Transmitting data. *See* Beaming information
- Truncating e-mail 165
- Turning off handheld
 - automatically 194
 - pen stroke for 187

- problems with 220
- Turning on handheld
 - application buttons 6
 - displaying owner's name 209
 - power button 7
 - problems with 220

U

- Undoing actions 61
- Uninstalling Desktop software 43
- Unresponsive handheld 220
- Unsent e-mail, editing 154
- Untimed events 80, 83, 85
- Updating data. *See* HotSync
- Upgrading Desktop software 4
- USB
 - connector 9
 - port 23
- User name
 - for ISP 196
 - identifying handheld 209
- User profiles 182

V

- Vendor for Expense item 141

W

- Web sites 24
- Week (Date Book view) 88–89, 193, 222
- Week with Text (Date Book Plus view) 95
- Writing area 6
- Writing. *See* Entering data

Y

- Year (Date Book Plus view) 96

Free Manuals Download Website

<http://myh66.com>

<http://usermanuals.us>

<http://www.somanuals.com>

<http://www.4manuals.cc>

<http://www.manual-lib.com>

<http://www.404manual.com>

<http://www.luxmanual.com>

<http://aubethermostatmanual.com>

Golf course search by state

<http://golfingnear.com>

Email search by domain

<http://emailbydomain.com>

Auto manuals search

<http://auto.somanuals.com>

TV manuals search

<http://tv.somanuals.com>