

**CENTRAL PNEUMATIC®**

# **TWIN TANK 2 HP AIR COMPRESSOR**

**Model 65410**

## **SET UP AND OPERATING INSTRUCTIONS**



Visit our website at: <http://www.harborfreight.com>



**Read this material before using this product.  
Failure to do so can result in serious injury.  
SAVE THIS MANUAL.**

Copyright© 2008 by Harbor Freight Tools®. All rights reserved. No portion of this manual or any artwork contained herein may be reproduced in any shape or form without the express written consent of Harbor Freight Tools. Diagrams within this manual may not be drawn proportionally. Due to continuing improvements, actual product may differ slightly from the product described herein. Tools required for assembly and service may not be included.

**For technical questions or replacement parts, please call 1-800-444-3353.**

Revised Manual 09k

---

## SAVE THIS MANUAL

---

Keep this manual for the safety warnings and precautions, assembly, operating, inspection, maintenance and cleaning procedures. Write the product's serial number in the back of the manual near the assembly diagram (or month and year of purchase if product has no number). Keep this manual and the receipt in a safe and dry place for future reference.

---

## IMPORTANT SAFETY INFORMATION

---

In this manual, on the labeling, and all other information provided with this product:



This is the safety alert symbol. It is used to alert you to potential personal injury hazards. Obey all safety messages that follow this symbol to avoid possible injury or death.

### **DANGER**

**DANGER** indicates a hazardous

situation which, if not avoided, will result in death or serious injury.

### **WARNING**

**WARNING** indicates a

hazardous situation which, if not avoided, could result in death or serious injury.

### **CAUTION**

**CAUTION**, used with the safety

alert symbol, indicates a hazardous situation which, if not avoided, could result in minor or moderate injury.

### **NOTICE**

**NOTICE** is used to address practices not related to personal injury.

### **CAUTION**

**CAUTION**, without the safety alert symbol, is used to address practices not related to personal injury.

---

## General Safety Warnings

---



**WARNING** Read all safety warnings and instructions. *Failure to follow the warnings and instructions may result in explosion, fire and/or serious injury.*

Save all warnings and instructions for future reference.

1. **Work area safety**
  - a. **Keep work area clean and well lit.** *Cluttered or dark areas invite accidents.*
  - b. **Do not operate tools in explosive atmospheres, such as in the presence of flammable liquids, gases or dust.** *Tools become hot which may ignite the dust or fumes.*
  - c. **Keep children and bystanders away while operating a tool.** *Distractions can cause you to lose control.*
2. **Electrical safety**
  - a. **Tool plugs must match the outlet. Never modify the plug in any way. Do not use any adapter plugs with grounded tools.** *Unmodified plugs and matching outlets will reduce risk of electric shock.*
  - b. **Avoid body contact with grounded surfaces such as pipes, radiators, ranges and refrigerators.** *There is*

*an increased risk of electric shock if your body is grounded.*

- c. **Do not expose tools to rain or wet conditions.** *Water entering a tool will increase the risk of electric shock.*
  - d. **Do not abuse the cord. Never use the cord for carrying, pulling or unplugging the tool. Keep cord away from heat, oil, sharp edges or moving parts.** *Damaged or entangled cords increase the risk of electric shock.*
  - e. **If operating a tool in a damp location is unavoidable, use a Ground Fault Circuit Interrupter (GFCI) protected supply.** *Use of a GFCI reduces the risk of electric shock.*
  - f. **Do not use an Extension cord with this product.**
3. **Personal safety**
- a. **Stay alert, watch what you are doing and use common sense when operating this tool. Do not use this tool while you are tired or under the influence of drugs, alcohol or medication.** *A moment of inattention while operating tools may result in serious personal injury.*
  - b. **Use personal protective equipment. Always wear eye protection.** *Safety equipment such as dust mask, non-skid safety shoes, hard hat, or hearing protection used for appropriate conditions will reduce personal injuries.*
  - c. **Prevent unintentional starting. Ensure the switch is in the off-position before connecting to power source or moving the tool.**
  - d. **Do not overreach. Keep proper footing and balance at all times.**

*This enables better control of the tool in unexpected situations.*

- e. **Dress properly. Do not wear loose clothing or jewelry. Keep your hair, clothing and gloves away from moving parts.** *Loose clothes, jewelry or long hair can be caught in moving parts.*
  - f. **Only use safety equipment that has been approved by an appropriate standards agency.** *Unapproved safety equipment may not provide adequate protection. Eye protection must be ANSI-approved and breathing protection must be NIOSH-approved for the specific hazards in the work area.*
4. **Tool use and care**
- a. **Do not force the tool. Use the correct tool for your application.** *The correct tool will do the job better and safer at the rate for which it was designed.*
  - b. **Do not use the tool if the switch does not turn it on and off.** *Any tool that cannot be controlled with the switch is dangerous and must be repaired.*
  - c. **Disconnect the plug from the power source of the tool before making any adjustments, changing accessories, or storing tools.** *Such preventive safety measures reduce the risk of starting the tool accidentally.*
  - d. **Store idle tools out of the reach of children and do not allow persons unfamiliar with the tool or these instructions to operate it.** *Tools are dangerous in the hands of untrained users.*

- e. **Maintain tools. Check for misalignment or binding of moving parts, breakage of parts and any other condition that may affect the tool's operation. If damaged, have the tool repaired before use. Many accidents are caused by poorly maintained tools.**
  - f. **Use the tool in accordance with these instructions, taking into account the working conditions and the work to be performed. Use of the tool for operations different from those intended could result in a hazardous situation.**
5. **Service**
- a. **Have your tool serviced by a qualified repair person using only identical replacement parts. This will ensure that the safety of the tool is maintained.**

### **Air Compressor Safety Warnings**

1. Risk of fire or explosion - do not spray flammable liquid in a confined area or towards a hot surface. Spray area must be well-ventilated. Do not smoke while spraying or spray where spark or flame is present. Arcing parts - keep compressor at least 20 feet away from explosive vapors, such as when spraying with a spray gun.
2. Risk of bursting - do not adjust regulator to result in output pressure greater than marked maximum pressure of attachment.
3. Risk of injury - do not direct air stream at body. To reduce the risk of electric shock, do not expose to rain. Store indoors.
4. Do not use to supply breathing air.
5. Do not direct air flow from the Compressor at people or animals.
6. Industrial applications must follow OSHA requirements.
7. Maintain labels and nameplates on the tool. These carry important safety information. If unreadable or missing, contact Harbor Freight Tools for a replacement.
8. Avoid unintentional starting. Prepare to begin work before turning on the tool.
9. Do not leave the tool unattended when it is plugged into an electrical outlet. Turn off the tool, and unplug it from its electrical outlet before leaving.
10. This product is not a toy. Keep it out of reach of children.
11. **WARNING:** The brass components of this product contain lead, a chemical known to the State of California to cause birth defects (or other reproductive harm). (California Health & Safety code § 25249.5, *et seq.*)
12. People with pacemakers should consult their physician(s) before use. Electromagnetic fields in close proximity to heart pacemaker could cause pacemaker interference or pacemaker failure. In addition, people with pacemakers should:
  - Avoid operating alone.
  - Do not use with power switch locked on.
  - Properly maintain and inspect to avoid electrical shock.
  - Any power cord must be properly grounded. Ground Fault Circuit Inter-

rupter (GFCI) should also be implemented – it prevents sustained electrical shock.

13. Some dust created by power sanding, sawing, grinding, drilling, and other construction activities, contains chemicals known [to the State of California] to cause cancer, birth defects or other reproductive harm. Some examples of these chemicals are:
- Lead from lead-based paints
  - Crystalline silica from bricks and cement or other masonry products
  - Arsenic and chromium from chemically treated lumber
- Your risk from these exposures varies, depending on how often you do this type of work. To reduce your exposure to these chemicals: work in a well ventilated area, and work with approved safety equipment, such as those dust masks that are specially designed to filter out microscopic particles. (California Health & Safety Code § 25249.5, *et seq.*)

14. **WARNING:** Handling the cord on this product will expose you to lead, a chemical known to the State of California to cause cancer, and birth defects or other reproductive harm. Wash hands after handling. (California Health & Safety Code § 25249.5, *et seq.*)

15. The warnings, precautions, and instructions discussed in this instruction manual cannot cover all possible conditions and situations that may occur. It must be understood by the operator that common sense and caution are factors which cannot be built into this product, but must be supplied by the operator.



## SAVE THESE INSTRUCTIONS.

---

### GROUNDING

---

#### **WARNING**

**TO PREVENT ELECTRIC SHOCK**



**AND DEATH FROM INCORRECT GROUNDING WIRE CONNECTION:** Check with a qualified electrician if you are in doubt as to whether the outlet is properly grounded. Do not modify the power cord plug provided with the tool. Never remove the grounding prong from the plug. Do not use the tool if the power cord or plug is damaged. If damaged, have it repaired by a service facility before use. If the plug will not fit the outlet, have a proper outlet installed by a qualified electrician.

---

#### **Grounded Tools: Tools with Three Prong Plugs**

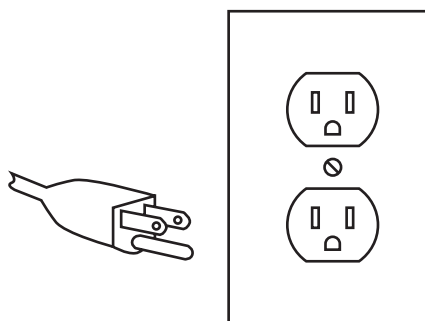





**3-Prong Plug and Outlet**

1. Tools marked with “Grounding Required” have a three wire cord and three prong grounding plug. The plug must be connected to a properly grounded outlet. If the tool should

electrically malfunction or break down, grounding provides a low resistance path to carry electricity away from the user, reducing the risk of electric shock. **(See 3-Prong Plug and Outlet.)**

2. The grounding prong in the plug is connected through the green wire inside the cord to the grounding system in the tool. The green wire in the cord must be the only wire connected to the tool's grounding system and must never be attached to an electrically "live" terminal. **(See 3-Prong Plug and Outlet.)**
3. The tool must be plugged into an appropriate outlet, properly installed and grounded in accordance with all codes and ordinances. The plug and outlet should look like those in the preceding illustration. **(See 3-Prong Plug and Outlet.)**

### Symbology

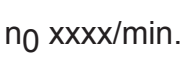
	Double Insulated
	Canadian Standards Association
	Underwriters Laboratories, Inc.
	Volts Alternating Current
	Amperes
	No Load Revolutions per Minute (RPM)

## SPECIFICATIONS

Electrical Requirements	120 V~ / 60 Hz / 14 A
Air Hose Connection	1/4" 18 NPT
Maximum Air Pressure	115 PSI
Air Tank Capacity	5 Gallons
Air Flow Capacity	5 SCFM @ 90 PSI 7.8 SCFM @ 40 PSI
Oil Tank Capacity	1/2 Quart
Oil Type	30W Non-Detergent Compressor Oil
Sound Level	98 dB @ 3'
Motor	2 HP

## UNPACKING

When unpacking, make sure that the item is intact and undamaged. If any parts are missing or broken, please call Harbor Freight Tools at the number shown on the cover of this manual as soon as possible.

## INSTRUCTIONS FOR PUTTING INTO USE



Read the **ENTIRE IMPORTANT SAFETY INFORMATION** section at the beginning of this manual including all text under subheadings therein before set up or use of this product.

### **WARNING**

#### **TO PREVENT SERIOUS INJURY**

#### **FROM ACCIDENTAL OPERATION:**

Turn the Power Switch of the tool to its "OFF" position and unplug the tool from its electrical outlet before assembling or making any adjustments to the tool.

**Note:** For additional information regarding the parts listed in the following pages, refer to the Assembly Diagram near the end of this manual.

## Assembly

1. Thread the Air Filter (44) onto the Cylinder Head (45), as shown below.

Connect Air Filter (44) here



2. Connect a 1/4" NPT air hose (rated 165 PSI or higher) to the air connection (47). The air hose must be long enough to reach the work area with enough extra length to allow free movement while working.
3. Incorporate an in-line oiler, shut-off valve, regulator with pressure gauge, and filter for best service, as shown in the diagram below. An in-line shutoff valve is an important safety device because it controls the air supply even if the air hose is ruptured.

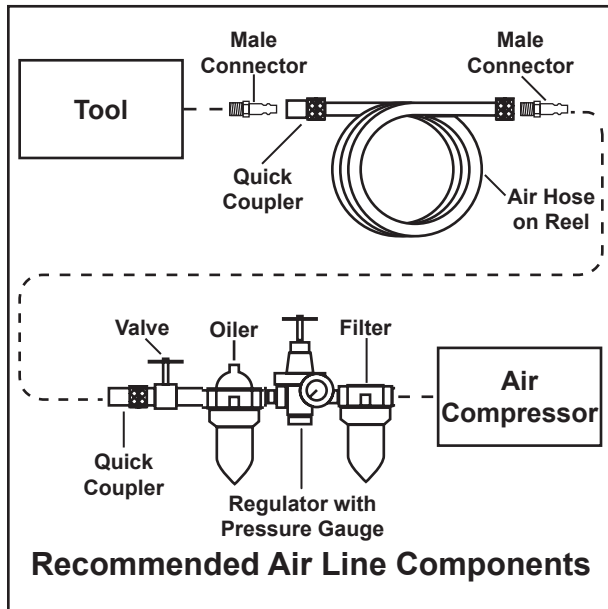

3. Close the in-line safety valve between the compressor and the tool.
4. Connect an air hose rated to the intended PSI that will be used with the tool to the Air Connection (47). The air hose must be long enough to reach the work area with enough extra length to allow free movement while working.
5. Plug the Power Cord into a grounded 120 V electrical outlet. Do not use an extension cord with this product.
6. Pull the Power Switch up to turn it on.

## OPERATING INSTRUCTIONS



Read the **ENTIRE IMPORTANT SAFETY INFORMATION** section at the beginning of this manual including all text under subheadings therein before set up or use of this product.

### **WARNING** TO PREVENT SERIOUS INJURY

**FROM ACCIDENTAL OPERATION:**  
Turn the Power Switch of the tool to its “OFF” position and unplug the tool from its electrical outlet before performing any inspection, maintenance, or cleaning procedures.

1. Make sure the air tool’s throttle or switch is in the off position.
2. Connect the tool that will be used for the job to the airline.



7. Allow the Air Compressor to build up pressure until it cycles off.
8. Open the Pressure Valve.
9. Adjust the air compressor’s Regulator so that the air output is enough



to properly power the tool, but the output will not exceed the tool's maximum air pressure at any time. Turn the knob clockwise to increase pressure and counter-clockwise to decrease pressure. Adjust the pressure gradually, while checking the air output gauge to set the right pressure range.

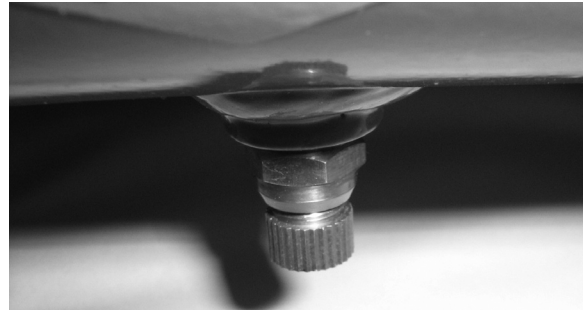

**Drain Valve**

10. The Air Compressor will cycle up to 115 PSI before shutting off. It will start to build pressure again when the PSI of the Compressor drops to 85 PSI.
11. After the job is complete, move the Power Switch to the OFF position.
12. Close the Pressure Valve.
13. Pull down on the Safety Valve underneath the Gauges to release pressure. Squeeze the Trigger of the air tool to release pressure from the line
15. Disconnect the air hose and tool.
16. To prevent accidents, disconnect its power supply after use. Clean, then store the tool indoors out of children's reach.

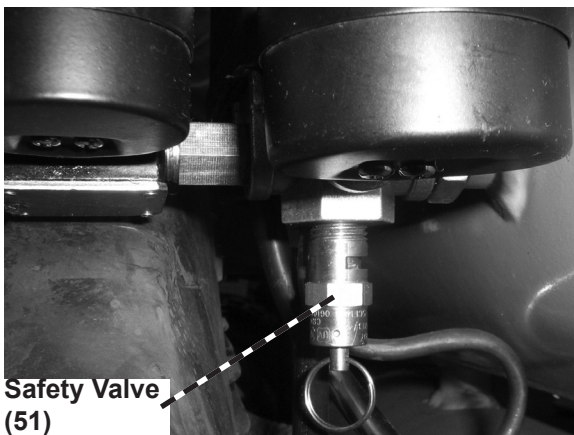

14. Turn the Drain Valve at the bottom of the Tank two turns to release any built-up moisture. Close the valve after moisture has drained out. Do not remove the Drain Valve.

---

## MAINTENANCE AND SERVICING

---



Procedures not specifically explained in this manual must be performed only by a qualified technician.

### **⚠️ WARNING**

#### **TO PREVENT SERIOUS INJURY**

##### **FROM ACCIDENTAL OPERATION:**

Turn the Power Switch of the tool to its “OFF” position and unplug the tool from its electrical outlet before performing any inspection, maintenance, or cleaning procedures.

##### **TO PREVENT SERIOUS INJURY FROM TOOL FAILURE:**

Do not use damaged equipment. If abnormal noise or vibration occurs, have the problem corrected before further use.

be replaced only by a qualified service technician.

---

### **PLEASE READ THE FOLLOWING CAREFULLY**

THE MANUFACTURER AND/OR DISTRIBUTOR HAS PROVIDED THE PARTS LIST AND ASSEMBLY DIAGRAM IN THIS MANUAL AS A REFERENCE TOOL ONLY. NEITHER THE MANUFACTURER OR DISTRIBUTOR MAKES ANY REPRESENTATION OR WARRANTY OF ANY KIND TO THE BUYER THAT HE OR SHE IS QUALIFIED TO MAKE ANY REPAIRS TO THE PRODUCT, OR THAT HE OR SHE IS QUALIFIED TO REPLACE ANY PARTS OF THE PRODUCT. IN FACT, THE MANUFACTURER AND/OR DISTRIBUTOR EXPRESSLY STATES THAT ALL REPAIRS AND PARTS REPLACEMENTS SHOULD BE UNDERTAKEN BY CERTIFIED AND LICENSED TECHNICIANS, AND NOT BY THE BUYER. THE BUYER ASSUMES ALL RISK AND LIABILITY ARISING OUT OF HIS OR HER REPAIRS TO THE ORIGINAL PRODUCT OR REPLACEMENT PARTS THERETO, OR ARISING OUT OF HIS OR HER INSTALLATION OF REPLACEMENT PARTS THERETO.

---

### **Cleaning, Maintenance, and Lubrication**

1. **BEFORE EACH USE**, inspect the general condition of the tool. Check for loose screws, misalignment or binding of moving parts, cracked or broken parts, damaged electrical wiring, and any other condition that may affect its safe operation.
2. **AFTER USE**, clean external surfaces of the tool with clean cloth.
3. **⚠️ WARNING!** If the supply cord of this power tool is damaged, it must

## Troubleshooting

<b>Problem</b>	<b>Possible Causes</b>	<b>Likely Solutions</b>
Overheating	<ol style="list-style-type: none"><li>1. Poor ventilation.</li><li>2. Dirty cooling surfaces.</li><li>3. Compressor undersized for application.</li></ol>	<ol style="list-style-type: none"><li>1. Move the compressor to an area with better air circulation.</li><li>2. Clean compressor.</li><li>3. Check air requirements of tools.</li></ol>
Compressor operates, but with low air output	<ol style="list-style-type: none"><li>1. Valve or regulator loose or leaking.</li><li>2. Valve or regulator damaged.</li><li>3. Air tank not pressurized yet.</li></ol>	<ol style="list-style-type: none"><li>1. Repair leaks.</li><li>2. Have valve or regulator repaired by a qualified technician.</li><li>3. Allow pressure to build.</li></ol>
Incorrect pressure gauge reading	<ol style="list-style-type: none"><li>1. Pressure gauge worn or damaged.</li></ol>	<ol style="list-style-type: none"><li>1. Have pressure gauge replaced by a qualified technician.</li></ol>



**Follow all safety precautions whenever diagnosing or servicing the tool. Disconnect air supply before service.**

## PARTS LIST

Part	Description
1	Cowl
2	Spring Washer
3	Washer
4	Pan Head Screw M5x14
5	Fan
6	Screw M5x15
7	Motor Rear Cover
8	Wave Washer
9	Bearing
10	Stator Assembly
11	Rotor Assembly
12	Capacitor
13	Bearing
14	Oil Seal
15	Nut M8
16	Crankcase
17	Crank
18	Screw M8x16
19	Crankcase Gasket
20	Crankcase Cover
21	Oil Leveler
22	Hex Head Screw
23	Pan Head Screw M6x14
24	Breather Assembly
25	Spring Washer 8
26	Washer 8
27	Screw M6x14
28	Connecting Rod
29	Piston
30	Circlip 12
31	Piston Pin
32	Cylinder Gasket
33	Cylinder
34	Spring Washer 6
35	Washer 6
36	Screw M6x40

## PARTS LIST

Part	Description
37	Oil Gasket
38	Seal Ring
39	Valve Plate Gasket
40	Valve Plate Assembly
41	Air Intake Valve
42	Limit Pin
43	Cylinder Head Gasket
44	Air Filter
45	Cylinder Head
46	Elbow Connector
47	Coupler
48	Pressure Regulator
49	Tool Pressure Gauge
50	Connector
51	Safety Valve Assembly
52	Pressure Switch Assembly
53	Tank Pressure Gauge
54	Hex Head Screw M6x25
55	Washer 6
56	Washer 6
57	Nut M6
58	Tank Assembly
59	Nut M8
60	Washer 8
61	Handle Sleeve
62	Washer 8
63	Hex Head Screw M8x40
64	Drain Valve
65	Nut
66	Rubber Foot
67	Cord/Plug
68	Pipe Assembly
69	Check Valve Assembly
70	Rear Motor Cover Gasket
71	Frame Assembly
72	Exhaust Pipe

**Record Product's Serial Number Here:** \_\_\_\_\_

**Note:** If product has no serial number, record month and year of purchase instead.

**Note:** Some parts are listed and shown for illustration purposes only, and are not available individually as replacement parts.

# ASSEMBLY DIAGRAM

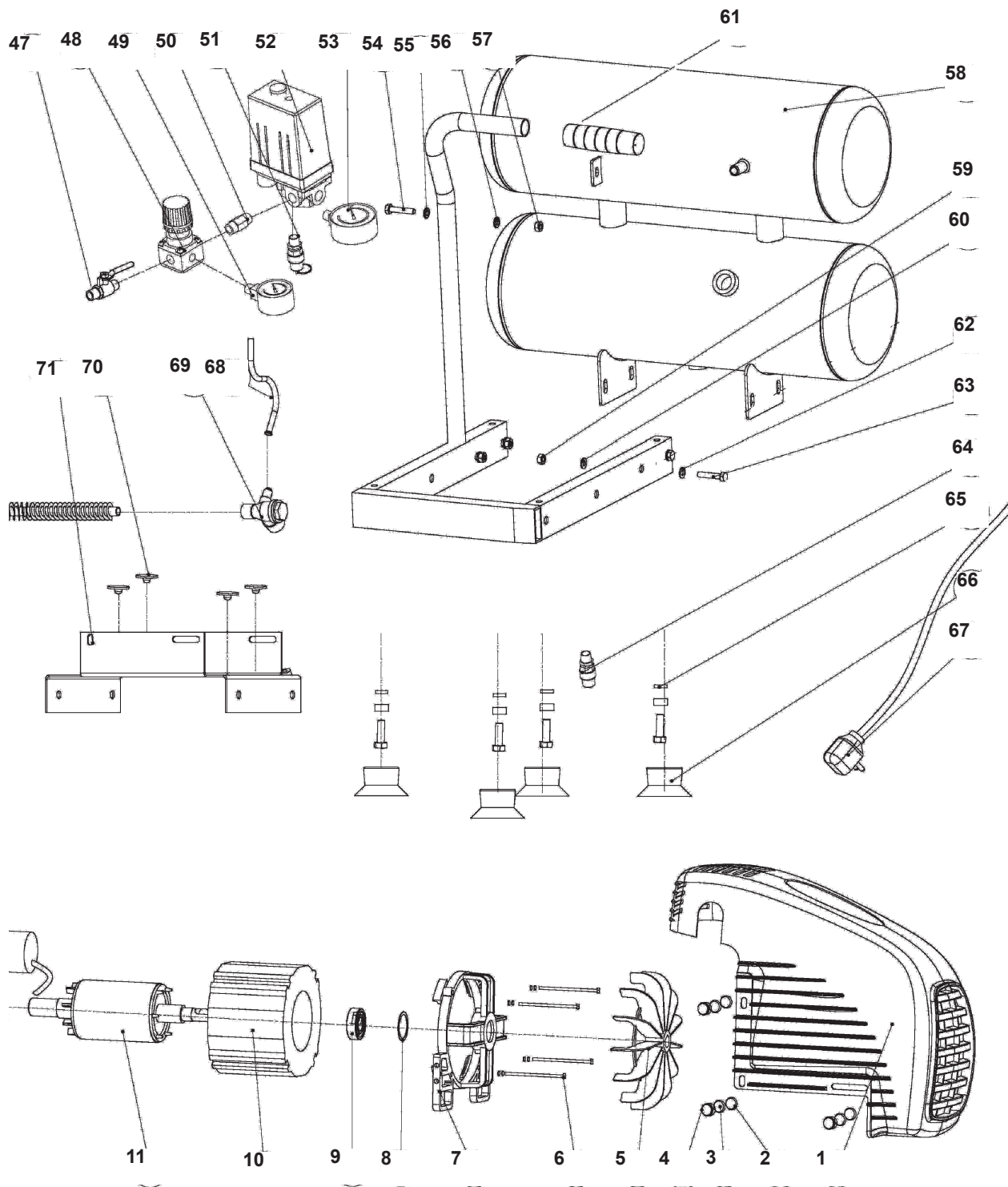

# ASSEMBLY DIAGRAM, CONTINUED

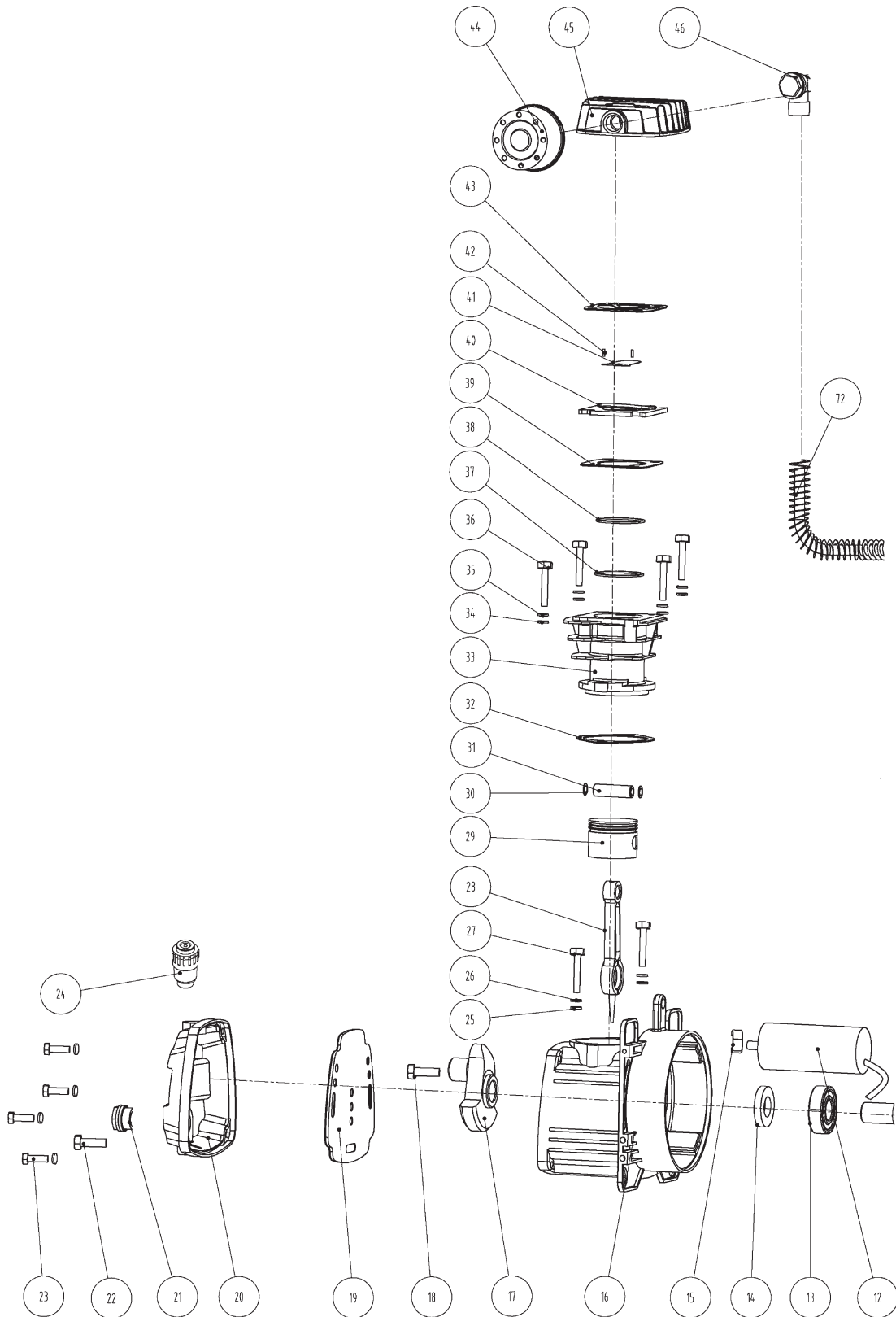

---

## LIMITED 1 YEAR / 90 DAY WARRANTY

---

Harbor Freight Tools Co. makes every effort to assure that its products meet high quality and durability standards, and warrants to the original purchaser that for a period of one year from date of purchase that the tank is free of defects in materials and workmanship (90 days if used by a professional contractor or if used as rental equipment). Harbor Freight Tools also warrants to the original purchaser, for a period of ninety days from date of purchase, that all other parts and components of the product are free from defects in materials and workmanship. This warranty does not apply to damage due directly or indirectly to misuse, abuse, negligence or accidents, repairs or alterations outside our facilities, normal wear and tear, or to lack of maintenance. We shall in no event be liable for death, injuries to persons or property, or for incidental, contingent, special or consequential damages arising from the use of our product. Some states do not allow the exclusion or limitation of incidental or consequential damages, so the above limitation of exclusion may not apply to you. THIS WARRANTY IS EXPRESSLY IN LIEU OF ALL OTHER WARRANTIES, EXPRESS OR IMPLIED, INCLUDING THE WARRANTIES OF MERCHANTABILITY AND FITNESS.

To take advantage of this warranty, the product or part must be returned to us with transportation charges prepaid. Proof of purchase date and an explanation of the complaint must accompany the merchandise. If our inspection verifies the defect, we will either repair or replace the product at our election or we may elect to refund the purchase price if we cannot readily and quickly provide you with a replacement. We will return repaired products at our expense, but if we determine there is no defect, or that the defect resulted from causes not within the scope of our warranty, then you must bear the cost of returning the product.

This warranty gives you specific legal rights and you may also have other rights which vary from state to state.

**3491 Mission Oaks Blvd. • PO Box 6009 • Camarillo, CA 93011 • (800) 444-3353**

## Free Manuals Download Website

<http://myh66.com>

<http://usermanuals.us>

<http://www.somanuals.com>

<http://www.4manuals.cc>

<http://www.manual-lib.com>

<http://www.404manual.com>

<http://www.luxmanual.com>

<http://aubethermostatmanual.com>

Golf course search by state

<http://golfingnear.com>

Email search by domain

<http://emailbydomain.com>

Auto manuals search

<http://auto.somanuals.com>

TV manuals search

<http://tv.somanuals.com>