



18 VOLT CORDLESS HAMMER DRILL KIT

Model 91176

ASSEMBLY AND OPERATING INSTRUCTIONS



3491 Mission Oaks Blvd., Camarillo, CA 93011
Visit our Web site at: <http://www.harborfreight.com>

Copyright© 2004 by Harbor Freight Tools®. All rights reserved. No portion of this manual or any artwork contained herein may be reproduced in any shape or form without the express written consent of Harbor Freight Tools.

For technical questions, please call 1-800-444-3353.

PRODUCT SPECIFICATIONS

Chuck Type	1/2" - Keyless Chuck
Revolutions Per Minute	0-500 RPM (low), 0-1600 RPM (high)
Torque Settings	7 (from 4.4 to 70.7 in.-Lbs.) Refer to <i>Torque Settings</i> chart on page 12.
Battery	18 VDC, Rechargeable NiCd
Weight (Drill Only)	5 Lbs.
Kit includes: Case, 5 drill bits, 5 driver bits, 2" Long Extender Adapter/Charger.	

SAVE THIS MANUAL

You will need this manual for the safety warnings and precautions, assembly, operating, inspection, maintenance and cleaning procedures, parts list and assembly diagram. Keep your invoice with this manual. Write the invoice number on the inside of the front cover. Keep this manual and invoice in a safe and dry place for future reference.

GENERAL SAFETY RULES

WARNING!

READ AND UNDERSTAND ALL INSTRUCTIONS
Failure to follow all instructions listed below may result in
electric shock, fire, and/or serious injury.
SAVE THESE INSTRUCTIONS

WORK AREA

1. **Keep your work area clean and well lit.** Cluttered benches and dark areas invite accidents.
2. **Do not operate power tools in explosive atmospheres, such as in the presence of flammable liquids, gases, or dust.** Power tools create sparks which may ignite the dust or fumes.
3. **Keep bystanders, children, and visitors away while operating a power tool.** Distractions can cause you to lose control. Protect others in the work area from debris such as chips and sparks. Provide barriers or shields as needed.

ELECTRICAL SAFETY

4. **Grounded adapters/chargers must be plugged into an outlet properly installed and grounded in accordance with all codes and ordinances. Never remove the grounding prong or modify the plug in any way. Do not use any adapter plugs. Check with a qualified electrician if you are in doubt as to whether the outlet is properly grounded.** If the Adapter/Charger should electrically malfunction or break down, grounding provides a low resistance path to carry electricity away from the user.
5. **Double insulated tools are equipped with a polarized plug (one blade is wider than the other). This plug will fit in a polarized outlet only one way. If the plug does not fit fully in the outlet, reverse the plug. If it still does not fit, contact a qualified electrician to install a polarized outlet. Do not change the plug in any way.** Double insulation eliminates the need for the three wire grounded power cord and grounded power supply system.
6. **Avoid body contact with grounded surfaces such as pipes, radiators, ranges, and refrigerators.** There is an increased risk of electric shock if your body is grounded.
7. **Do not expose power tools to rain or wet conditions.** Water entering a power tool will increase the risk of electric shock.
8. **Do not abuse the Power Cord. Never use the Power Cord to carry the tools or pull the Plug from an outlet. Keep the Power Cord away from heat, oil, sharp edges, or moving parts. Replace damaged Power Cords immediately.** Damaged Power Cords increase the risk of electric shock.
9. **When operating a power tool outside, use an outdoor extension cord marked “W-A” or “W”.** These extension cords are rated for outdoor use, and reduce the risk of electric shock.

PERSONAL SAFETY

10. **Stay alert. Watch what you are doing, and use common sense when operating a power tool. Do not use a power tool while tired or under the influence of drugs, alcohol, or medication.** A moment of inattention while operating power tools may result in serious personal injury.
11. **Dress properly. Do not wear loose clothing or jewelry. Contain long hair. Keep your hair, clothing, and gloves away from moving parts.** Loose clothes, jewelry, or long hair can be caught in moving parts.

12. **Avoid accidental starting. Be sure the Trigger is off before plugging in.** Carrying power tools with your finger on the Trigger, or adding a battery with the Trigger depressed, invites accidents.
13. **Remove adjusting keys or wrenches before turning the power tool on.** A wrench or a key that is left attached to a rotating part of the power tool may result in personal injury.
14. **Do not overreach. Keep proper footing and balance at all times.** Proper footing and balance enables better control of the power tool in unexpected situations.
15. **Use safety equipment. Always wear eye protection.** Dust mask, non-skid safety shoes, hard hat, or hearing protection must be used for appropriate conditions.

TOOL USE AND CARE

16. **Use clamps (not included) or other practical ways to secure and support the workpiece to a stable platform.** Holding the work by hand or against your body is unstable and may lead to loss of control.
17. **Do not force the tool. Use the correct tool for your application.** The correct tool will do the job better and safer at the rate for which it is designed.
18. **Do not use the power tool if the Trigger does not turn it on or off.** Any tool that cannot be controlled with the Trigger is dangerous and must be replaced.
19. **Disconnect the Power Cord Plug from the power source before making any adjustments, changing batteries, or storing the Charger.**
20. **Store idle tools out of reach of children and other untrained persons.** Tools are dangerous in the hands of untrained users.
21. **Maintain tools with care. Keep tools clean and bits sharp.** Properly maintained tools and sharp bits are less likely to bind and are easier to control. Do not use a damaged tool. Tag damaged tools "Do not use" until repaired.
22. **Check for misalignment or binding of moving parts, breakage of parts, and any other condition that may affect the tool's operation. If damaged, have the tool serviced before using.** Many accidents are caused by poorly maintained tools.



23. **Use only accessories that are recommended by the manufacturer for your model.** Accessories that may be suitable for one tool may become hazardous when used on another tool.

SERVICE

24. **Tool service must be performed only by qualified repair personnel.** Service or maintenance performed by unqualified personnel could result in a risk of injury.
25. **When servicing a tool, use only identical replacement parts. Follow instructions in the “*Inspection, Maintenance, And Cleaning*” section of this manual.** Use of unauthorized parts or failure to follow maintenance instructions may create a risk of electric shock or injury.

SPECIFIC SAFETY RULES

1. **Maintain labels and nameplates on the Hammer Drill.** These carry important information. If unreadable or missing, contact Harbor Freight Tools for a replacement.
2. **Always wear safety impact eye goggles and heavy work gloves when using the Hammer Drill.** Using personal safety devices reduce the risk for injury. Safety impact eye goggles and heavy work gloves are available from Harbor Freight Tools.
3. **Maintain a safe working environment.** Keep the work area well lit. Make sure there is adequate surrounding workspace. Always keep the work area free of obstructions, grease, oil, trash, and other debris. Do not use a power tool in areas near flammable chemicals, dusts, and vapors. Do not use this product in a damp or wet location.
4. **When using a handheld power tool, always maintain a firm grip on the tool with both hands to resist starting torque.**
5. **Avoid unintentional starting.** Make sure you are prepared to begin work before turning on the Hammer Drill.
6. **Do not force the Hammer Drill.** This tool will do the work better and safer at the speed and capacity for which it was designed.

7. **Always remove the Battery Pack (14) before operation, inspection, maintenance, or cleaning procedures.**
8. **Know what you are drilling into.** When drilling into a structure, make sure no electrical wires, cables, or plumbing is behind the surface.
9.  **WARNING!** Some dust created by power sanding, sawing, grinding, drilling, and other construction activities, contain chemicals known (to the State of California) to cause cancer, birth defects or other reproductive harm. Some examples of these chemicals are: lead from lead-based paints, crystalline silica from bricks and cement or other masonry products, arsenic and chromium from chemically treated lumber. Your risk from these exposures varies, depending on how often you do this type of work. To reduce your exposure to these chemicals: work in a well ventilated area, and work with approved safety equipment, such as those dust masks that are specially designed to filter out microscopic particles. *(California Health & Safety Code 25249.5, et seq.)*
10.  **WARNING!** People with pacemakers should consult their physician(s) before using this product. Electromagnetic fields in close proximity to a heart pacemaker could cause interference to or failure of the pacemaker.
In addition, people with pacemakers should adhere to the following:
 - Avoid operating power tools alone.
 - Don't use a power tool with the power switch locked on.
 - If powered via a power cord be certain that the tool is properly grounded. A ground fault interrupt (GFCI) system is also a good precaution. This inexpensive device is a good safety measure because it prevents a sustained electrical shock.
 - Properly maintain and inspect all tools before use to avoid electrical shock.

GROUNDING

WARNING!

Improperly connecting the grounding wire can result in the risk of electric shock. Check with a qualified electrician if you are in doubt as to whether the outlet is properly grounded. Do not modify the power cord plug provided with the tool. Never remove the grounding prong from the plug. Do not use the tool if the power cord or plug is damaged. If damaged, have it repaired by a service facility before use. If the plug will not fit the outlet, have a proper outlet installed by a qualified electrician.

GROUNDING TOOLS: TOOLS WITH THREE PRONG PLUGS

1. Tools marked with “Grounding Required” have a three wire cord and three prong grounding plug. The plug must be connected to a properly grounded outlet. If the tool should electrically malfunction or break down, grounding provides a low resistance path to carry electricity away from the user, reducing the risk of electric shock. **(See Figure A.)**
2. The grounding prong in the plug is connected through the green wire inside the cord to the grounding system in the tool. The green wire in the cord must be the only wire connected to the tool’s grounding system and must never be attached to an electrically “live” terminal. **(See Figure A.)**
3. Your tool must be plugged into an appropriate outlet, properly installed and grounded in accordance with all codes and ordinances. The plug and outlet should look like those in the following illustration. **(See Figure A.)**

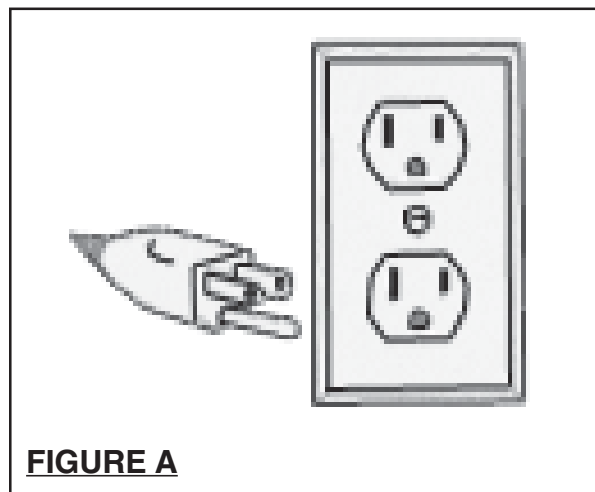

DOUBLE INSULATED TOOLS: TOOLS WITH TWO PRONG PLUGS

4. Tools marked "Double Insulated" do not require grounding. They have a special double insulation system which satisfies OSHA requirements and complies with the applicable standards of Underwriters Laboratories, Inc., the Canadian Standard Association, and the National Electrical Code. **(See Figure B.)**
5. Double insulated tools may be used in either of the 120 volt outlets shown in the following illustration. **(See Figure B.)**

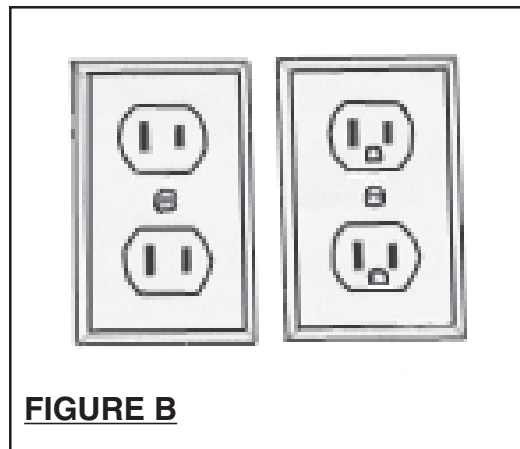

EXTENSION CORDS



1. **Grounded** tools require a three wire extension cord. **Double Insulated** tools can use either a two or three wire extension cord.
2. As the distance from the supply outlet increases, you must use a heavier gauge extension cord. Using extension cords with inadequately sized wire causes a serious drop in voltage, resulting in loss of power and possible tool damage. **(See Figure C, next page.)**
3. The smaller the gauge number of the wire, the greater the capacity of the cord. For example, a 14 gauge cord can carry a higher current than a 16 gauge cord. **(See Figure C.)**
4. When using more than one extension cord to make up the total length, make sure each cord contains at least the minimum wire size required. **(See Figure C.)**
5. If you are using one extension cord for more than one tool, add the nameplate amperes and use the sum to determine the required minimum cord size. **(See Figure C.)**

6. If you are using an extension cord outdoors, make sure it is marked with the suffix "W-A" ("W" in Canada) to indicate it is acceptable for outdoor use.
7. Make sure your extension cord is properly wired and in good electrical condition. Always replace a damaged extension cord or have it repaired by a qualified electrician before using it.
8. Protect your extension cords from sharp objects, excessive heat, and damp or wet areas.

RECOMMENDED MINIMUM WIRE GAUGE FOR EXTENSION CORDS* (120 VOLT)					
NAMEPLATE AMPERES (At Full Load)	EXTENSION CORD LENGTH				
	25 FEET	50 FEET	75 FEET	100 FEET	150 FEET
0 - 2.0	18	18	16	16	16
2.1 - 3.4	18	18	16	14	14
3.5 - 5.0	18	18	16	14	12
5.1 - 7.0	18	16	14	12	12
7.1 - 12.0	18	14	12	10	-
12.1 - 16.0	14	12	10	-	-
16.1 - 20.0	12	10	-	-	-

FIGURE C *Based on limiting the line voltage drop to five volts at 150% of the rated amperes.

SYMBOLOLOGY

	Double Insulated
	Canadian Standards Association
	Underwriters Laboratories, Inc.
V ~	Volts Alternating Current
A	Amperes
n_oxxxx/min.	No Load Revolutions per Minute (RPM)

UNPACKING

When unpacking, check to make sure all the parts shown on the **Parts List on page 14** are included. If any parts are missing or broken, please call Harbor Freight Tools at the number shown on the cover of this manual as soon as possible.

OPERATING INSTRUCTIONS

NOTE: For additional information regarding the parts listed in the following pages, refer to the **Assembly Diagram on page 15**.

Battery Pack (14) and Adapter (20) Use

1. Plug the Adapter power cord into an outlet. When the Adapter (20) is plugged in, but not connected to the battery, both lights should be lit (if this is not happening exchange the adapter). When the battery is connected only the red light should be lit. When the battery is fully charged the red light should go out and the green light should come on. This may take up to 5 hours
2. Slide the Adapter into the slot on the top of the Battery Pack (14) until it clicks into place. To remove the Adapter, press the release button on the Battery Pack (14) and slide the Adapter (20) out. The Battery Pack (14) needs an initial charge of approximately 5 hours. After the initial charge, recharge the unit for approximately 3 to 5 hours. **Never charge the battery more than 5 hours.** See **FIGURES 1** and **3**.
3. To check the power level on the Battery Pack (14), press the TEST button on the Battery Pack (14). See **FIGURE 2**. Always after charging, use the TEST button to make sure a fully lit green light is on, showing a fully charged battery. When pushing the TEST button, if the lights are partially lit, that indicates a partial charge. When fully lit, Red = low charge, Yellow = 1/2 charge, Green = Full Charge. Test the Battery Pack periodically during operation and charge as needed.
Note: These lights show the approximate level of charge.
4. To load the Battery Pack (14) onto the Hammer Drill, just slide it along the bottom of the Base (13/17) until it clicks into place. Press the release button to remove the Battery Pack (14). See **FIGURE 3**.

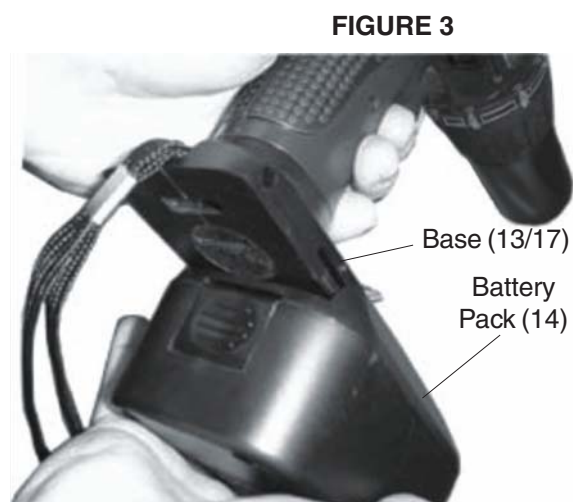
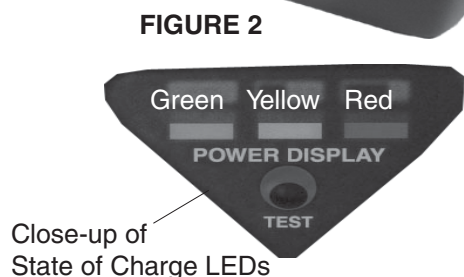
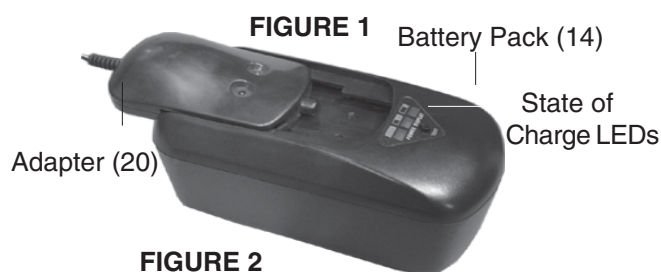

OPERATING INSTRUCTIONS (Continued)

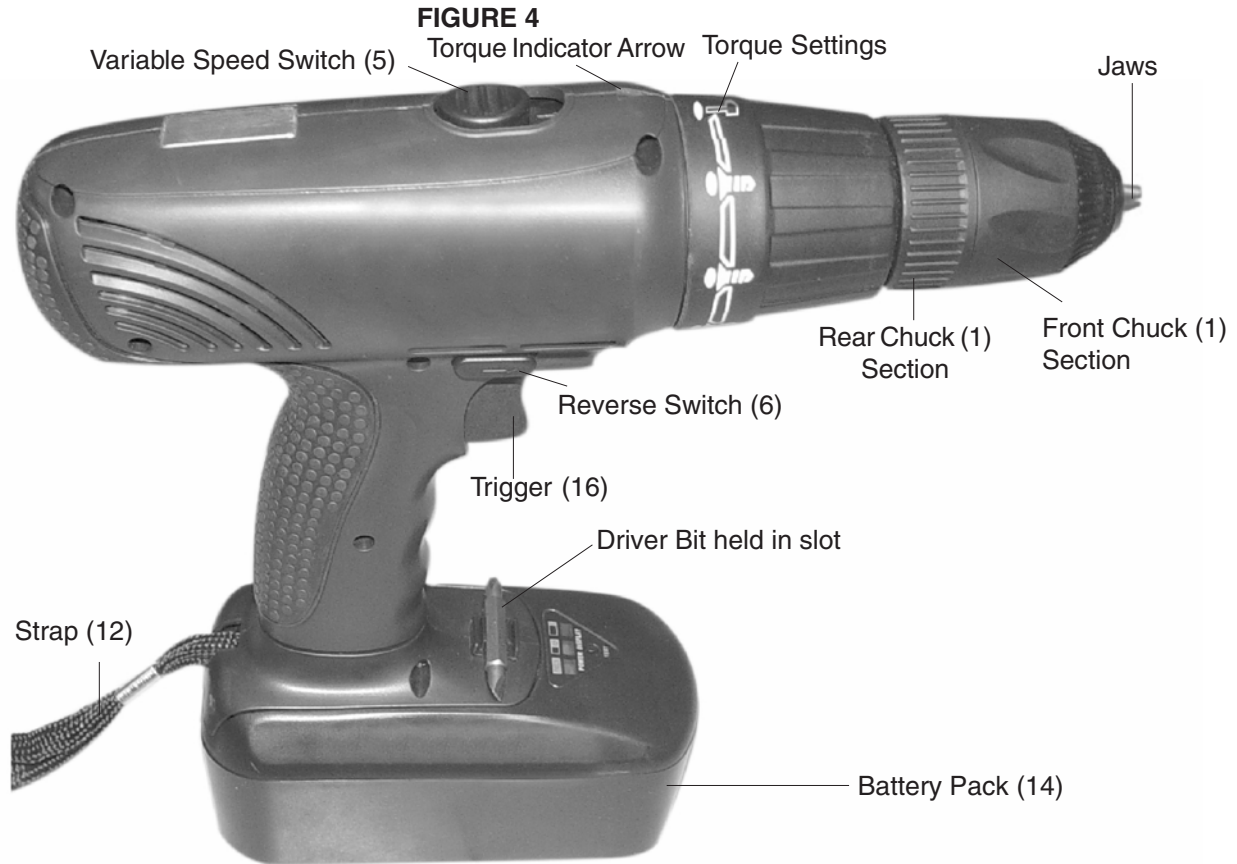

NOTE: Always switch to a fresh battery when tool performance begins to diminish. Severe heat is most destructive to a battery; the more heat generated, the faster the battery loses power. A battery that gets too hot can be permanently damaged. Never over-discharge a battery by continuing to pull the tool trigger. When tool performance begins to diminish, stop the tool, recharge the battery, and use a fresh battery for optimal performance.

1. **CAUTION:** Always make sure the Battery Pack (14) is not attached to the Hammer Drill *prior* to making any adjustments and adding or removing bits to the tool.
2. Determine the size bit you will use. With one hand, hold the rear section of the Chuck (1) firmly. With the other hand, turn the front section of the Chuck (1) counterclockwise to loosen the Chuck (1) and open the Jaws. See **FIGURE 4**. Insert the non-cutting end of the bit into the Jaws at least 1/4". Holding the rear section of the Chuck (1) firmly, turn the front section of the Chuck (1) clockwise to tighten the Chuck (1) and close the Jaws. Make sure the bit is securely held in the Jaws of the Chuck (1) by putting on a thick work glove and pulling on the bit.

ASSEMBLY AND OPERATING INSTRUCTIONS (Continued)

- Set the speed by adjusting the Variable Speed Switch (5) to either 1 (low) or 2 (high). High speed is generally used for drilling applications and low speed is generally used for screw driving applications. See **FIGURE 5**.

- Set the Torque by aligning the desired Torque setting with the Torque Indicator Arrow. See **FIGURE 5**. There are seven Torque setting icons. They range from low driving settings, to drill settings, to the impact or hammer drill setting. When using the Hammer Drill setting, line up the Hammer Icon with the Torque Indicator Arrow as shown in **FIGURE 5**. When using the Hammer Drill as a driver, use the Driver Icons, also shown. The Drill Icon is not shown in figure 5 but looks like a drill bit. Higher torque settings (Drill Icon or Hammer) will break the heads off of screws. Only use the Drill setting to bore or drill into an object. The Hammer Setting works well when drilling/chipping into concrete. It is generally used to bore holes with the purpose of breaking up material.

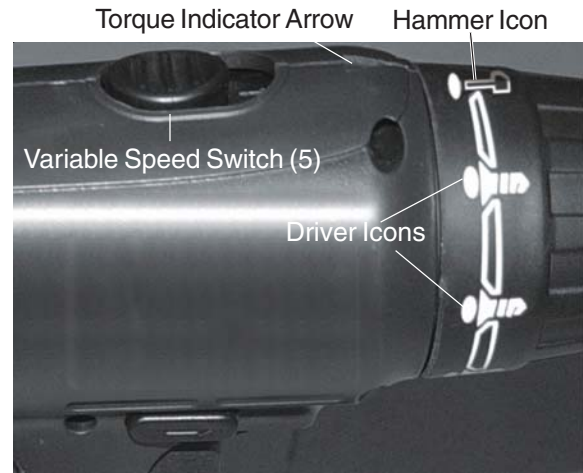

FIGURE 5

- Attach a Battery Pack (14) as explained on page 10.
- Holding the Hammer Drill clear of all obstacles, test it by gently pulling on the Trigger (16). If the bit turns clockwise, you are in the drilling or driving position. If the bit turns counterclockwise, you are in the reverse position (to remove a screw or help pull a bit out of a workpiece). Adjust the Reverse Switch (6) to change direction. Do not use the Reverse Switch (6) when the drill is rotating.

Torque Settings

Setting	Approximate Torque Amount (in inch-pounds)
1	4.4-5.3
2	5.3-7.1
3	7.1-10.6
4	10.6-17.7
5	17.7-26.6
6	26.6-53.1
7	70.7

Drilling Tips

- After the workpiece is secure, use an awl (not included) to punch a starter hole for the drill bit. Place the bit on the workpiece prior to starting the Hammer Drill. Holding the Hammer Drill with both hands, gently squeeze the Trigger (16) increasing your tension on the Trigger (16) after you are sure the bit is securely in the pilot hole. After completing the task, stop the Hammer Drill, reverse the direction of the drill (see number 6 above), and gently squeeze the Trigger (6) as you back out the drill.

ASSEMBLY AND OPERATING INSTRUCTIONS (Continued)

Driving Screws

8. After attaching the appropriate driver bit and securing your workpiece, use an awl (not included) to punch in a pilot hole for the screw tip. Insert the driver bit in the screw head and place the tip of the screw into the pilot hole. Slowly squeeze the Trigger (16) allowing the screw to bite into the workpiece. Gradually add more power by squeezing on Trigger (16). To remove screws, insert the driver bit in the screw head and set the drill into reverse mode (see number 6 on page 12) and slowly squeeze the Trigger (16) to back out the screw.
9. After using the Hammer Drill, remove the Battery Pack (14) and then remove the bit from the Chuck (1) as explained on page 11.

Note: Periodically check the TEST button on the Battery Pack to check the battery status.

INSPECTION, MAINTENANCE, AND CLEANING

1.  **WARNING!** Make sure the Trigger (16) of the Hammer Drill is in its “OFF” position and that the tool does not have a Battery Pack (14) attached before performing any inspection, maintenance, or cleaning procedures.
2. **BEFORE EACH USE**, inspect the general condition of the Hammer Drill. Check for loose screws, misalignment or binding of moving parts, cracked or broken parts, damaged electrical wiring, and any other condition that may affect its safe operation. If abnormal noise or vibration occurs, have the problem corrected before further use. **Do not use damaged equipment.**
3. After each use, wipe the unit down with a lint free cloth.
4. Check that the Jaws of the Chuck (1) are clear of any dirt, debris, or grease.
5. Check bits carefully. Never use a cracked or bent bit. New bits are available at Harbor Freight Tools.
6. Properly recycle or dispose of Ni-Cd battery when it no longer recharges. Do not throw the battery in a fire. Contact your local hazardous waste disposal authority for proper disposal.

PARTS LIST

Part No.	Description
1	Chuck
2	Gear Box
3	Label
4	Right Housing
5	Variable Speed Switch
6	Reverse Switch
7	MOS Tube
8	Radiating Flange
9	Magnetic Block
10	Left Housing
11	Label
12	Strap
13	Left Base
14	Battery Pack
15	Revolving Base
16	Trigger
17	Right Base
18	Bit Set
19	Screw M3x14
20	AC/DC Adapter Charger Base

PLEASE READ THE FOLLOWING CAREFULLY

THE MANUFACTURER AND/OR DISTRIBUTOR HAS PROVIDED THE PARTS LIST AND ASSEMBLY DIAGRAM IN THIS MANUAL AS A REFERENCE TOOL ONLY. NEITHER THE MANUFACTURER OR DISTRIBUTOR MAKES ANY REPRESENTATION OR WARRANTY OF ANY KIND TO THE BUYER THAT HE OR SHE IS QUALIFIED TO MAKE ANY REPAIRS TO THE PRODUCT, OR THAT HE OR SHE IS QUALIFIED TO REPLACE ANY PARTS OF THE PRODUCT. IN FACT, THE MANUFACTURER AND/OR DISTRIBUTOR EXPRESSLY STATES THAT ALL REPAIRS AND PARTS REPLACEMENTS SHOULD BE UNDERTAKEN BY CERTIFIED AND LICENSED TECHNICIANS, AND NOT BY THE BUYER. THE BUYER ASSUMES ALL RISK AND LIABILITY ARISING OUT OF HIS OR HER REPAIRS TO THE ORIGINAL PRODUCT OR REPLACEMENT PARTS THERETO, OR ARISING OUT OF HIS OR HER INSTALLATION OF REPLACEMENT PARTS THERETO.

ASSEMBLY DIAGRAM

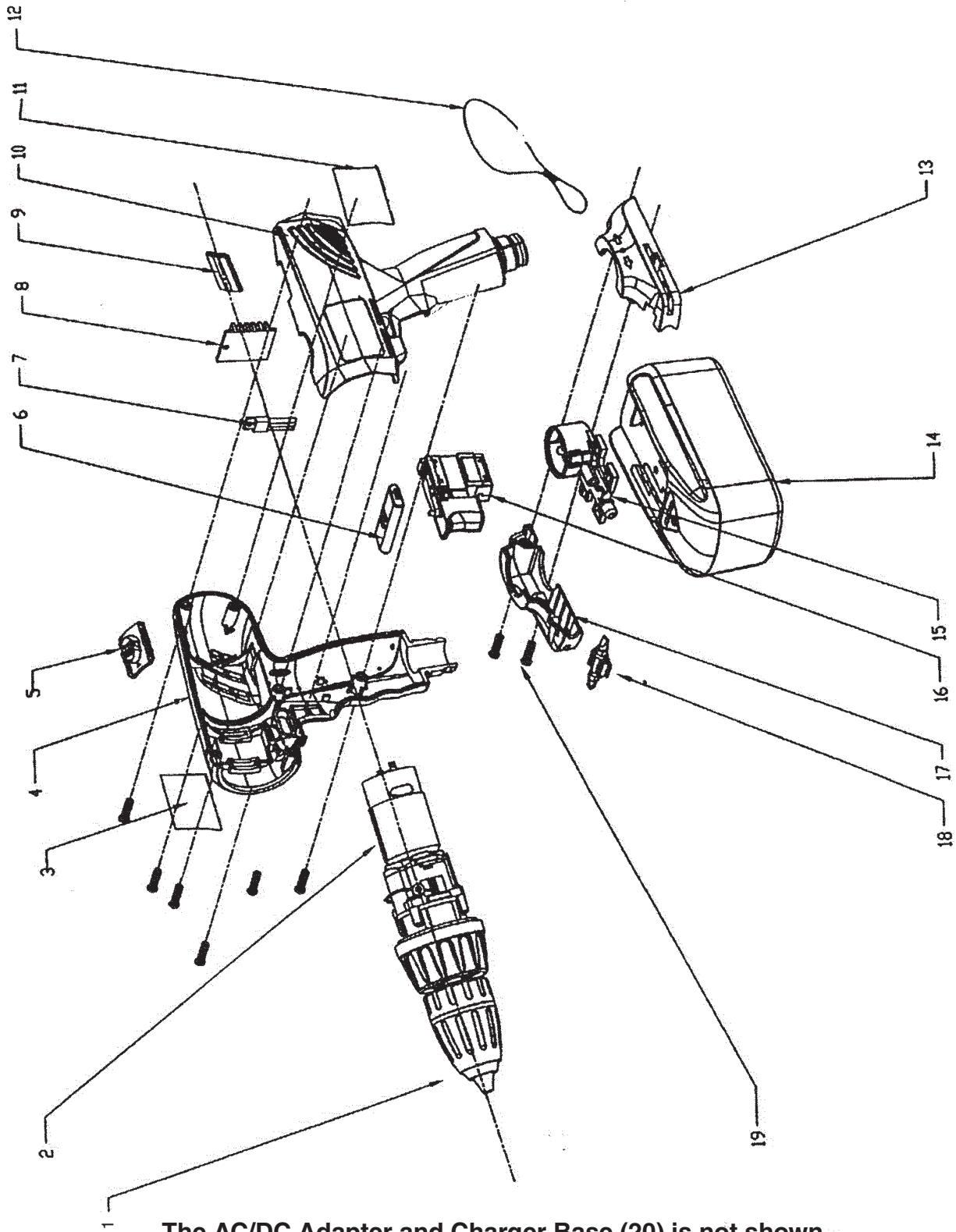

The AC/DC Adapter and Charger Base (20) is not shown.

NOTE: Some parts are listed and shown for illustration purposes only, and are not available individually as replacement parts.

Free Manuals Download Website

<http://myh66.com>

<http://usermanuals.us>

<http://www.somanuals.com>

<http://www.4manuals.cc>

<http://www.manual-lib.com>

<http://www.404manual.com>

<http://www.luxmanual.com>

<http://aubethermostatmanual.com>

Golf course search by state

<http://golfingnear.com>

Email search by domain

<http://emailbydomain.com>

Auto manuals search

<http://auto.somanuals.com>

TV manuals search

<http://tv.somanuals.com>