



# CORDLESS DRILL

## VARIABLE SPEED - 18 VOLT

Model 90120

### OPERATING INSTRUCTIONS



3491 Mission Oaks Blvd., Camarillo, CA 93011

Visit our Web site at: <http://www.harborfreight.com>

Copyright© 2003 by Harbor Freight Tools®. All rights reserved. No portion of this manual or any artwork contained herein may be reproduced in any shape or form without the express written consent of Harbor Freight Tools.

**For technical questions or replacement parts, please call 1-800-444-3353.**

Manual revised 01/05

## PRODUCT SPECIFICATIONS

Item	Description
Power Source	18 VDC NiCd Battery
Charge Time	3 to 5 Hours
Charger Input	120 VAC / 60 Hz
Chuck Type	3/8" Keyless
Variable Speed	0 to 900 RPM
Torque Settings	16
Reversible	Yes
Trigger Lock	Yes
Weight	4 Pounds

## SAVE THIS MANUAL

You will need this manual for the safety warnings and precautions, assembly, operating, inspection, maintenance and cleaning procedures, parts list and assembly diagram. Keep your invoice with this manual. Write the invoice number on the inside of the front cover. Keep this manual and invoice in a safe and dry place for future reference.

## GENERAL SAFETY RULES

 **WARNING!**

**READ AND UNDERSTAND ALL INSTRUCTIONS**  
Failure to follow all instructions listed below may result in electric shock, fire, and/or serious injury.  
**SAVE THESE INSTRUCTIONS**

### WORK AREA

1. **Keep your work area clean and well lit.** Cluttered benches and dark areas invite accidents.
2. **Do not operate power tools in explosive atmospheres, such as in the presence of flammable liquids, gases, or dust.** Power tools create sparks which may ignite the dust or fumes.

3. **Keep bystanders, children, and visitors away while operating a power tool.** Distractions can cause you to lose control. Protect others in the work area from debris such as chips and sparks. Provide barriers or shields as needed.

### ELECTRICAL SAFETY

4. **Grounded tools must be plugged into an outlet properly installed and grounded in accordance with all codes and ordinances. Never remove the grounding prong or modify the plug in any way. Do not use any adapter plugs. Check with a qualified electrician if you are in doubt as to whether the outlet is properly grounded.** If the tools should electrically malfunction or break down, grounding provides a low resistance path to carry electricity away from the user.
5. **Double insulated tools are equipped with a polarized plug (one blade is wider than the other). This plug will fit in a polarized outlet only one way. If the plug does not fit fully in the outlet, reverse the plug. If it still does not fit, contact a qualified electrician to install a polarized outlet. Do not change the plug in any way.** Double insulation  eliminates the need for the three wire grounded power cord and grounded power supply system.
6. **Avoid body contact with grounded surfaces such as pipes, radiators, ranges, and refrigerators.** There is an increased risk of electric shock if your body is grounded.
7. **Do not expose power tools to rain or wet conditions.** Water entering a power tool will increase the risk of electric shock.
8. **Do not abuse the Adapter's power cord. Never use the Power Cord to carry the Charger or pull the Plug from an outlet. Keep the Power Cord away from heat, oil, sharp edges, or moving parts. Replace damaged Power Cords immediately.** Damaged Power Cords increase the risk of electric shock.

### PERSONAL SAFETY

9. **Stay alert. Watch what you are doing, and use common sense when operating a power tool. Do not use a power tool while tired or under the influence of drugs, alcohol, or medication.** A moment of inattention while operating power tools may result in serious personal injury.
10. **Dress properly. Do not wear loose clothing or jewelry. Contain long hair. Keep your hair, clothing, and gloves away from moving parts.** Loose clothes, jewelry, or long hair can be caught in moving parts.
11. **Avoid accidental starting. Be sure the Rotation Button (33) is in the locked position before inserting the Battery.** Carrying power tools with your finger on the trigger, or inserting the Battery with the trigger depressed, invites accidents.
12. **Do not overreach. Keep proper footing and balance at all times.** Proper footing and balance enables better control of the power tool in unexpected situations.

13. **Use safety equipment. Always wear eye protection.** Dust mask, nonskid safety shoes, hard hat, or hearing protection must be used for appropriate conditions. Always wear ANSI approved safety goggles when working with this tool.

#### TOOL USE AND CARE

14. **Use clamps (not included) or other practical ways to secure and support the workpiece to a stable platform.** Holding the work by hand or against your body is unstable and may lead to loss of control.
15. **Do not force the tool. Use the correct tool for your application.** The correct tool will do the job better and safer at the rate for which it is designed.
16. **Do not use the power tool if the trigger does not operate it.** Any tool that cannot be controlled with the trigger is dangerous and must be replaced.
17. **Remove the battery from the tool and set the Rotation Button (33) to its center, locked position before making any adjustments, changing accessories, or storing the tool.** Such preventive safety measures reduce the risk of starting the tool accidentally.
18. **Store idle tools out of reach of children and other untrained persons.** Tools are dangerous in the hands of untrained users.
19. **Maintain tools with care. Keep drill bits sharp and clean.** Properly maintained accessories with a sharp cutting edge are less likely to bind and are easier to control. Do not use a damaged tool or accessory. Tag damaged tools "Do not use" until repaired.
20. **Check for misalignment or binding of moving parts, breakage of parts, and any other condition that may affect the tool's operation. If damaged, have the tool serviced before using.** Many accidents are caused by poorly maintained tools.
21. **Use only accessories that are recommended by the manufacturer for your model.** Accessories that may be suitable for one tool may become hazardous when used on another tool.

#### SERVICE

22. **Tool service must be performed only by qualified repair personnel.** Service or maintenance performed by unqualified personnel could result in a risk of injury.
23. **When servicing a tool, use only identical replacement parts. Follow instructions in the "Inspection, Maintenance, and Cleaning" section of this manual.** Use of unauthorized parts or failure to follow maintenance instructions may create a risk of electric shock or injury.

## SPECIFIC SAFETY RULES

1. **Maintain a safe working environment.** Keep the work area well lit. Make sure there is adequate surrounding workspace. Always keep the work area free of obstructions, grease, oil, trash, and other debris. Do not use the Cordless Drill in areas near flammable chemicals, dusts, and vapors. Do not use this product in a damp or wet location.
2. **Maintain labels and nameplates on the Cordless Drill.** These carry important information. If unreadable or missing, contact Harbor Freight Tools for a replacement.
3. **When using the Cordless Drill, always maintain a firm grip on the tool with both hands.**
4. **Hold the tool by its insulated gripping surfaces when performing an operation where the Cordless Drill may contact hidden wiring.** Contact with a “live” wire will make exposed metal parts of the Cordless Drill “live” and shock the operator.
5. **Do not use the Cordless Drill or Charger (34) if it has been dropped, damaged, left outdoors, or immersed in liquid.**
6. **To avoid electrical shock, do not pull or carry the Charger (34) by its Power Cord or pull the Power Cord around sharp corners or edges.** Do not unplug the Charger by pulling on the Power Cord. Keep the Power Cord away from heated surfaces.
7. **To avoid electrical shock, do not handle the Charger (34), its Adapter (35), or the Cordless Drill with wet hands.**
8. **Keep the Handle of the Cordless Drill dry, clean, free from oil and grease.**
9. **Avoid unintentional starting.** Make sure you are prepared to begin work before turning on the Cordless Drill.
10. **Never leave the Charger (34) unattended when it is plugged into an electrical outlet.** Make sure to unplug it from its electrical outlet before leaving.
11. **PROPER BATTERY PACK CARE:** Battery Pack (4) leakage may occur under extreme usage or temperature conditions. If Battery Pack fluid comes in contact with skin, wash with soap and water and rinse with lemon juice and vinegar. If the fluid comes into contact with the eyes, flush with water for several minutes and contact a doctor immediately. Never burn the Battery Pack, as it can explode in a fire. Do not charge the Cordless Drill with a leaking Battery Pack. Contact local solid waste authorities for instructions on correct disposal or recycling of the Battery Pack.
12.  **WARNING!** Some dust created by power sanding, sawing, grinding, drilling, and other construction activities, contain chemicals known (to the State of California) to cause cancer, birth defects or other reproductive harm. Some examples of

these chemicals are: lead from lead-based paints, crystalline silica from bricks and cement or other masonry products, arsenic and chromium from chemically treated lumber. Your risk from these exposures varies, depending on how often you do this type of work. To reduce your exposure to these chemicals: work in a well ventilated area, and work with approved safety equipment, such as those dust masks that are specially designed to filter out microscopic particles. (California Health & Safety Code § 25249.5, *et seq.*)

13.  **WARNING!** People with pacemakers should consult their physician(s) before using this product. Operation of electrical equipment in close proximity to a heart pacemaker could cause interference or failure of the pacemaker.

## GROUNDING

### **WARNING!**

**Improperly connecting the grounding wire can result in the risk of electric shock. Check with a qualified electrician if you are in doubt as to whether the outlet is properly grounded. Do not modify the power cord plug provided with the tool. Never remove the grounding prong from the plug. Do not use the tool if the power cord or plug is damaged. If damaged, have it repaired by a service facility before use. If the plug will not fit the outlet, have a proper outlet installed by a qualified electrician.**

### GROUNDING TOOLS: TOOLS WITH THREE PRONG PLUGS

1. Tools marked with “Grounding Required” have a three wire cord and three prong grounding plug. The plug must be connected to a properly grounded outlet. If the tool should electrically malfunction or break down, grounding provides a low resistance path to carry electricity away from the user, reducing the risk of electric shock. **(See Figure A, next page.)**
2. The grounding prong in the plug is connected through the green wire inside the cord to the grounding system in the tool. The green wire in the cord must be the only wire connected to the tool’s grounding system and must never be attached to an electrically “live” terminal. **(See Figure A.)**
3. Your tool must be plugged into an appropriate outlet, properly installed and grounded in accordance with all codes and ordinances. The plug and outlet should look like those in **Figure A.**

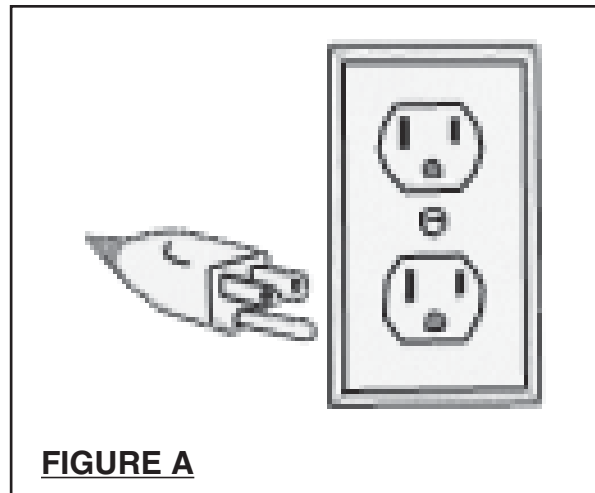

**FIGURE A**

**DOUBLE INSULATED TOOLS: TOOLS WITH TWO PRONG PLUGS**

4. Tools marked “Double Insulated” do not require grounding. They have a special double insulation system which satisfies OSHA requirements and complies with the applicable standards of Underwriters Laboratories, Inc., the Canadian Standard Association, and the National Electrical Code. **(See Figure B.)**
5. Double insulated tools may be used in either of the 120 volt outlets shown in the following illustration. **(See Figure B.)**

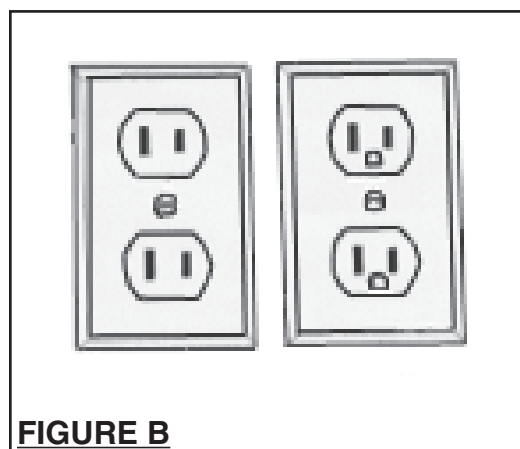

**FIGURE B**

## EXTENSION CORDS

1. **Grounded** tools require a three wire extension cord. **Double Insulated** tools can use either a two or three wire extension cord.
2. As the distance from the supply outlet increases, you must use a heavier gauge extension cord. Using extension cords with inadequately sized wire causes a serious drop in voltage, resulting in loss of power and possible tool damage. **(See Figure C.)**
3. The smaller the gauge number of the wire, the greater the capacity of the cord. For example, a 14 gauge cord can carry a higher current than a 16 gauge cord. **(See Figure C.)**
4. When using more than one extension cord to make up the total length, make sure each cord contains at least the minimum wire size required. **(See Figure C.)**
5. If you are using one extension cord for more than one tool, add the nameplate amperes and use the sum to determine the required minimum cord size. **(See Figure C.)**
6. If you are using an extension cord outdoors, make sure it is marked with the suffix "W-A" ("W" in Canada) to indicate it is acceptable for outdoor use.
7. Make sure your extension cord is properly wired and in good electrical condition. Always replace a damaged extension cord or have it repaired by a qualified electrician before using it.
8. Protect your extension cords from sharp objects, excessive heat, and damp or wet areas.



<b>RECOMMENDED MINIMUM WIRE GAUGE FOR EXTENSION CORDS*</b> <b>(120 VOLT)</b>					
<b>NAMEPLATE AMPERES (At Full Load)</b>	<b>EXTENSION CORD LENGTH</b>				
	<b>25 Feet</b>	<b>50 Feet</b>	<b>75 Feet</b>	<b>100 Feet</b>	<b>150 Feet</b>
<b>0 – 2.0</b>	<b>18</b>	<b>18</b>	<b>18</b>	<b>18</b>	<b>16</b>
<b>2.1 – 3.4</b>	<b>18</b>	<b>18</b>	<b>18</b>	<b>16</b>	<b>14</b>
<b>3.5 – 5.0</b>	<b>18</b>	<b>18</b>	<b>16</b>	<b>14</b>	<b>12</b>
<b>5.1 – 7.0</b>	<b>18</b>	<b>16</b>	<b>14</b>	<b>12</b>	<b>12</b>
<b>7.1 – 12.0</b>	<b>18</b>	<b>14</b>	<b>12</b>	<b>10</b>	<b>-</b>
<b>12.1 – 16.0</b>	<b>14</b>	<b>12</b>	<b>10</b>	<b>-</b>	<b>-</b>
<b>16.1 – 20.0</b>	<b>12</b>	<b>10</b>	<b>-</b>	<b>-</b>	<b>-</b>

\* Based on limiting the line voltage drop to five volts at 150% of the rated amperes.

**FIGURE C**



## SYMBOLOLOGY

	Double Insulated
	Canadian Standards Association
	Underwriters Laboratories, Inc.
<b>V</b> ~	Volts Alternating Current
<b>A</b>	Amperes
$n_o$ <u>xxxx</u> /min.	No Load Revolutions per Minute (RPM)

## UNPACKING

When unpacking, check to make sure that the product is complete and undamaged (see **Parts List on page 14** for reference). If any parts are missing or broken, please call Harbor Freight Tools at the number shown on the cover of this manual as soon as possible.

## CHARGING

1. **NOTE:** The Battery Pack (4) requires charging. The first charge requires **5 hours** charge time prior to using the Cordless Drill.
2. **Note:** **Always switch to a fresh battery when tool performance begins to diminish.** Severe heat is most destructive to a battery; the more heat generated, the faster the battery loses power. A battery that gets too hot can be permanently damaged. Never over-discharge a battery by using the tool even after tool performance is decreasing. Never attempt to discharge a tool's battery by continuing to pull the tool trigger. **When tool performance begins to diminish, stop the tool, recharge the battery and use the fresh battery for optimal performance.**

3. When the Battery Pack (4) requires recharging, a **3 to 5 hour** charge allows the tool to operate at full power. Do not recharge the Battery Pack longer than 5 hours, as damage to the Battery Pack and/or Cordless Drill will occur.
4. Charging room temperature: 50° F – 104° F. Insert the Battery Pack (4) into the Charger (34). Next, plug the Charger Adapter (35) into the socket on the side of the Charger (34). Then, plug the Charger Adapter (35) into the nearest 120 volt, grounded, electrical outlet. **(See Figure D, below.)**

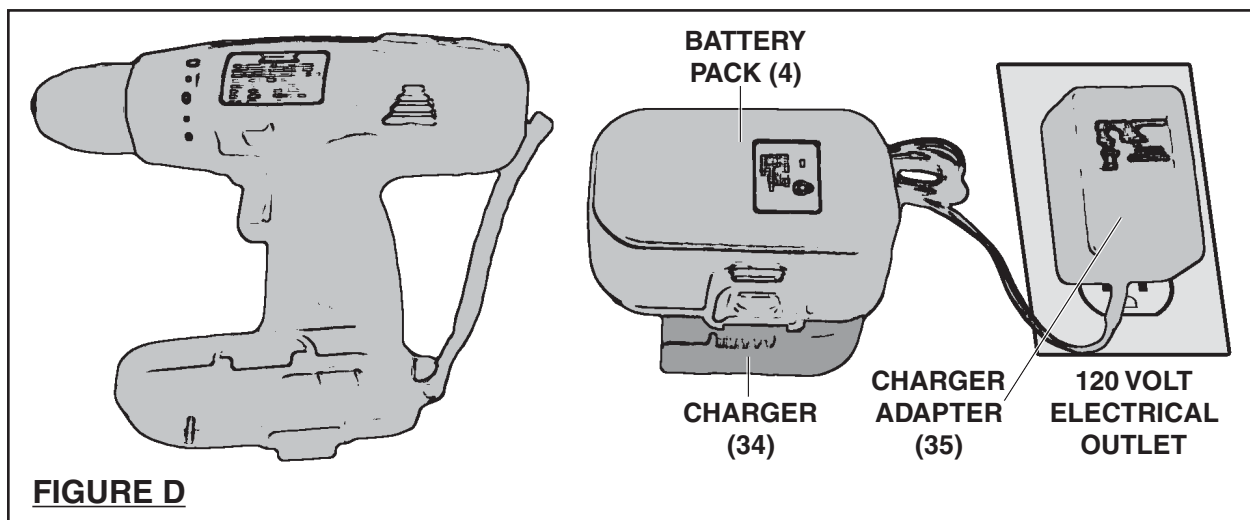

5. A Charging Indicator Light on the Charger (34) will illuminate to show that charging is taking place. **NOTE:** The Charger (34) will **not** automatically turn off when the Battery Pack is fully charged, and the Charging Indicator Light will remain on until the Charger is disconnected from the electrical outlet. Recharging the Battery Pack more than **5 hours** can cause damage to the battery cells.
6. While charging, the Battery Pack (4), Charger (34), and Charger Adapter (35) may become warm to the touch. This is normal, and does not indicate a problem.
7. Once the Battery Pack (4) is fully charged, disconnect the Charger Adapter (35) from the electrical outlet. Then, disconnect the Charger Adapter (35) and Battery Pack (4) from the Charger.

## OPERATING INSTRUCTIONS

**NOTE:** For additional information regarding the parts listed in the following pages, refer to the **Assembly Diagram on page 14.**

1. **WARNING!** Remove the Battery (4) from the tool and set the Rotation Button (33) to its center, locked position before making any adjustments, changing accessories, or storing the tool.

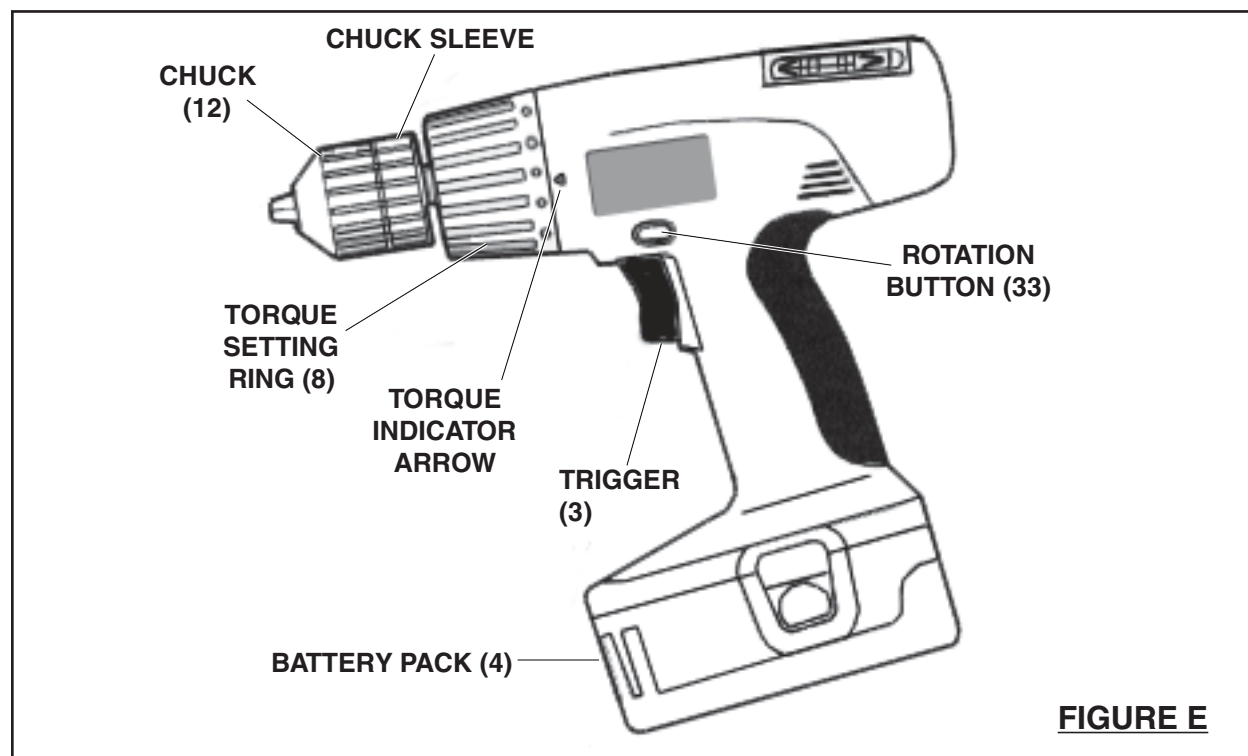

**FIGURE E**

2. To install a drill/screwdriver bit, hold the Chuck Sleeve firmly in place and turn the Chuck (12) *counterclockwise*. Insert the shank of the bit all the way into the Chuck (12). While holding the Chuck Sleeve in place, turn the Chuck *clockwise* to lock the bit in place. The Chuck (12) accepts up to  $\frac{3}{8}$ " diameter bits. Insert the appropriate bit for your application and tighten the Chuck (12) firmly. **(See Figure E, above.)**
3. Secure the workpiece in place, using a vise or clamps (not included).
4. The Torque Setting Ring (8) allows you to select 16 different driving torque settings, depending on the job required.

### Torque Settings (1-8):

The different numbers on the Ring are an indication of how much torque the screwdriver will apply to the bit before the clutch slips, allowing the bit to stop and helping to prevent damage to the screw, bit, or workpiece. The higher the number, the more torque is applied before the clutch slips. Unless you are drilling, always start with a lower number to help prevent damage. This drill also has torque settings between the numbers to allow a greater range of control.

### Drill Setting

This setting essentially prevents the clutch from slipping entirely. It is designed for drilling, but is not advised for using the screwdriver because it offers no protection against stripping the head or splitting the wood.

Set the driving torque by turning the Torque Setting Ring (8) to align the torque indicator arrow with the desired setting. **(See Figure E, previous page.)**

5. When drilling in light gauge metal or wood, use a wooden block to back up the material to prevent damage to the workpiece.
6. Mark the center of the hole to be drilled with a center punch to give a Drill Bit a start and to prevent it from “walking”.
7. Lubricate the Drill Bit with cutting oil when drilling iron or steel. Use a coolant when drilling nonferrous metals such as copper, brass, or aluminum.
8. Insert the fully charged Battery Pack (4) into the Handle of the Cordless Drill.
9. The Rotation Button (33) allows you to change the rotational direction of the Cordless Drill. For a clockwise rotation, move the Rotation Button to the *right*. For a counterclockwise rotation, move the Rotation Button to the *left*. The center position locks the Trigger (3), helping to prevent the Drill from operating. **(See Figure E.)**
10. Make sure to hold the Cordless Drill firmly with both hands, as torque from the Motor will cause the tool to twist.
11. Operate the Drill, by squeezing the Trigger (3). The speed of the Drill can be controlled by varying the pressure on the Trigger (3).
12. **If Drilling:**
  - Use the Drill torque setting, as described above.
  - Drill only as deep as necessary. Do not drill deeper than necessary into walls or other areas where you cannot identify any possible hazards behind the drilling surface.
  - To reduce jamming as the Bit breaks through the workpiece, decrease the drilling pressure when the point of the Bit breaks through the workpiece.
  - When you have drilled the hole, remove the Bit from the hole while the Cordless Drill is still running. This prevents the Bit from getting caught in the hole and causing damage.
13. **If Driving Screws:**
  - Start with a low torque setting.
  - If the clutch starts slipping before the screw is in all the way, stop the drill, put the Reverse Button (33) in the center position, remove the Battery (4), and change the torque setting. Reinstall the Battery (4), and set the direction before continuing.
13. Release the Trigger (3) to stop the Drill. Then, remove the Battery Pack (4), put the Reverse Button (33) in the center position, and remove the bit from the Drill.

## INSPECTION, MAINTENANCE, AND CLEANING

1.  **WARNING!** Remove the Battery (4) from the tool and set the Rotation Button (33) to its center, locked position before performing any inspection, maintenance, or cleaning.
2. **BEFORE EACH USE**, inspect the general condition of the Cordless Drill. Check for misalignment or binding of moving parts, cracked or broken parts, leaking Battery Pack, damaged Charger wiring, chipped or broken Drill Bits, and any other condition that may affect its safe operation. If abnormal noise or vibration occurs, have the problem corrected before further use.  
**Do not use damaged equipment.**
3. **DAILY:** With a soft brush or cloth, remove all dirt and debris from the Cordless Drill. Do not immerse the Cordless Drill in any liquids.
4. **If the battery needs replacement keep in mind that the Nickel-Cadmium (Ni-Cd) battery in this tool must be recycled or disposed of properly.**

## PLEASE READ THE FOLLOWING CAREFULLY

THE MANUFACTURER AND/OR DISTRIBUTOR HAS PROVIDED THE PARTS LIST AND ASSEMBLY DIAGRAM IN THIS MANUAL AS A REFERENCE TOOL ONLY. NEITHER THE MANUFACTURER OR DISTRIBUTOR MAKES ANY REPRESENTATION OR WARRANTY OF ANY KIND TO THE BUYER THAT HE OR SHE IS QUALIFIED TO MAKE ANY REPAIRS TO THE PRODUCT, OR THAT HE OR SHE IS QUALIFIED TO REPLACE ANY PARTS OF THE PRODUCT. IN FACT, THE MANUFACTURER AND/OR DISTRIBUTOR EXPRESSLY STATES THAT ALL REPAIRS AND PARTS REPLACEMENTS SHOULD BE UNDERTAKEN BY CERTIFIED AND LICENSED TECHNICIANS, AND NOT BY THE BUYER. THE BUYER ASSUMES ALL RISK AND LIABILITY ARISING OUT OF HIS OR HER REPAIRS TO THE ORIGINAL PRODUCT OR REPLACEMENT PARTS THERETO, OR ARISING OUT OF HIS OR HER INSTALLATION OF REPLACEMENT PARTS THERETO.

## PARTS LIST

Part	Description
1	Self Tapping Screw
2	Right Enclosure
3	Trigger Switch Assembly
4	Battery Pack
5	Ring
6	Spring
7	Inner Threaded Ring
8	Torque Setting Ring
9	Torque Positioning Spring
10	Spring Holder
11	Self Tapping Screw
12	Chuck

Part	Description
13	Chuck Screw
14	Ball Bearings
15	Fixing Ring
16	Small Ring
17	Small Ball Bearings
18	Governor Box
19	Shaft Coat
20	Spindle
21	Gear Ring
22	Planetary Gear
23	Planetary Bracket
24	Planetary Gear

Part	Description
25	Washer
26	Self Tapping Screw
27	Motor Flange
28	Self Tapping Screw
29	Motor
30	Left Enclosure
31	Screwdriver Bit
32	Bit Clip
33	Rotation Button
34	Charger
35	Charger Adapter

## ASSEMBLY DIAGRAM

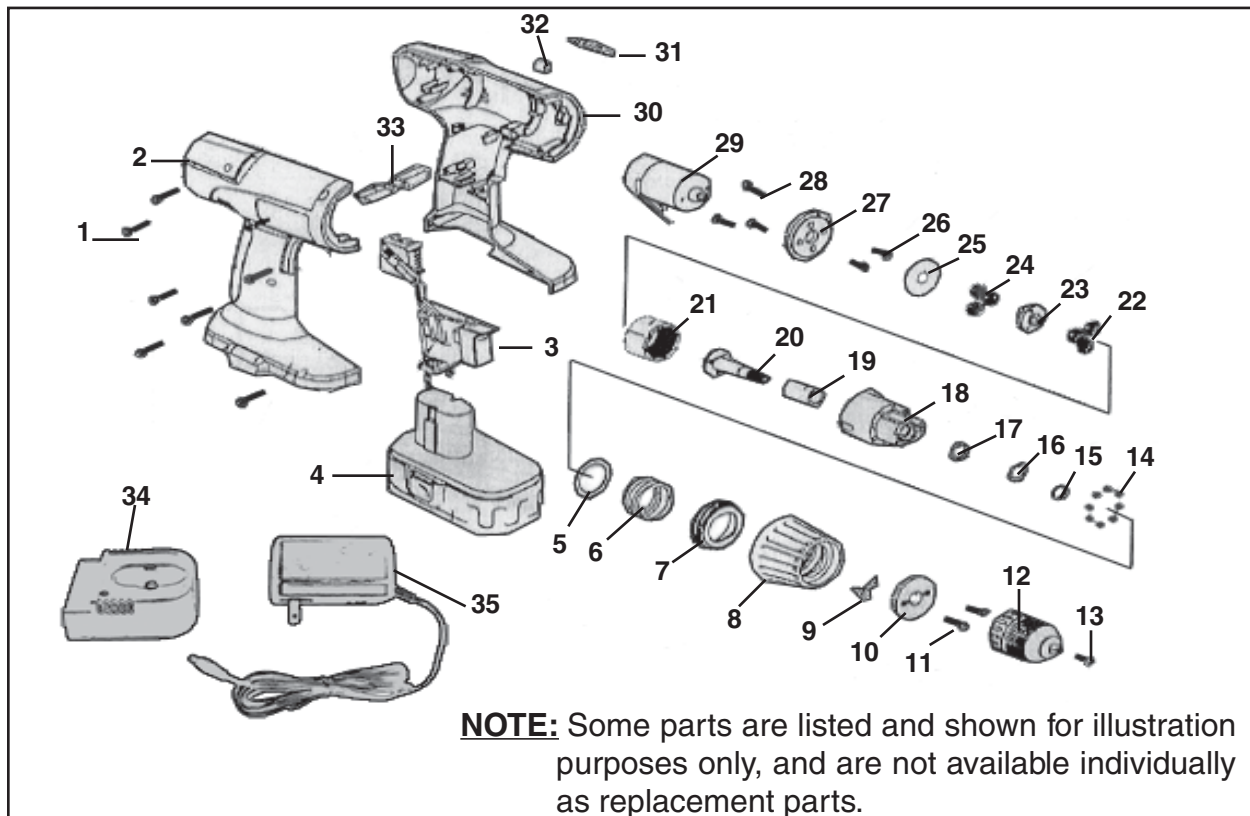

## Free Manuals Download Website

<http://myh66.com>

<http://usermanuals.us>

<http://www.somanuals.com>

<http://www.4manuals.cc>

<http://www.manual-lib.com>

<http://www.404manual.com>

<http://www.luxmanual.com>

<http://aubethermostatmanual.com>

Golf course search by state

<http://golfingnear.com>

Email search by domain

<http://emailbydomain.com>

Auto manuals search

<http://auto.somanuals.com>

TV manuals search

<http://tv.somanuals.com>