



# 4-1/2" ANGLE GRINDER

Model 95578

## ASSEMBLY AND OPERATING INSTRUCTIONS



Due to continuing improvements, actual product may differ slightly from the product described herein.



3491 Mission Oaks Blvd., Camarillo, CA 93011  
Visit our Web site at: <http://www.harborfreight.com>

**TO PREVENT SERIOUS INJURY,  
READ AND UNDERSTAND ALL WARNINGS  
AND INSTRUCTIONS BEFORE USE.**

Copyright © 2006 by Harbor Freight Tools® All right reserved. No portion of this manual or any artwork contained herein may be reproduced in any shape or form without the express written consent of Harbor Freight Tools.

**For technical questions, please call 1-800-444-3353.**

## PRODUCT SPECIFICATIONS

Item	Description
Electrical Requirements	120 VAC / 60 Hz / 4.2 Amps / 11,000 RPM Power Cord Type: 18 AWG x 2C / 6' Long Power Plug Type: 2-Prong / Polarized Power Switch Type: Toggle (ON/OFF)
Spindle Size	5/8"-11 TPI with 7/8" Arbor Adapter
Required Grinding Wheel Size (Not Included)	4-1/2" Diameter 1/4" Thick 7/8" Spindle Hole
Side Handle Dimensions	4-1/2" Long x 2-1/4" O.D.
Overall Dimensions	10-1/8" Long x 8" Wide x 3-3/4" High (with Side Handle)
Net Weight	3.5 Pounds

## SAVE THIS MANUAL

You will need this manual for the safety warnings and precautions, assembly, operating, inspection, maintenance and cleaning procedures, parts list and assembly diagram. Keep your invoice with this manual. Write the invoice number on the inside of the front cover. Keep this manual and invoice in a safe and dry place for future reference.

## GENERAL SAFETY RULES

 **WARNING!**  
**READ AND UNDERSTAND ALL INSTRUCTIONS**  
Failure to follow all instructions listed below may result in electric shock, fire, and/or serious injury.  
**SAVE THESE INSTRUCTIONS**

### WORK AREA

1. **Keep your work area clean and well lit.** Cluttered benches and dark areas invite accidents.
2. **Do not operate power tools in explosive atmospheres, such as in the presence of flammable liquids, gases, or dust.** Power tools create sparks which may ignite the dust or fumes.
3. **Keep bystanders, children, and visitors away while operating a power tool.** Distractions can cause you to lose control. Protect others in the work area from debris such as chips and sparks. Provide barriers or shields as needed. Children should not be allowed in the work area.

## ELECTRICAL SAFETY

4. **Grounded tools must be plugged into an outlet properly installed and grounded in accordance with all codes and ordinances. Never remove the grounding prong or modify the plug in any way. Do not use any adapter plugs. Check with a qualified electrician if you are in doubt as to whether the outlet is properly grounded.** If the tools should electrically malfunction or break down, grounding provides a low resistance path to carry electricity away from the user.
5. **Double insulated tools are equipped with a polarized plug (one blade is wider than the other). This plug will fit in a polarized outlet only one way. If the plug does not fit fully in the outlet, reverse the plug. If it still does not fit, contact a qualified electrician to install a polarized outlet. Do not change the plug in any way.** Double insulation  eliminates the need for the three wire grounded power cord and grounded power supply system.
6. **Avoid body contact with grounded surfaces such as pipes, radiators, ranges, and refrigerators.** There is an increased risk of electric shock if your body is grounded.
7. **Do not expose power tools to rain or wet conditions.** Water entering a power tool will increase the risk of electric shock.
8. **Do not abuse the Power Cord. Never use the Power Cord to carry the tools or pull the Plug from an outlet. Keep the Power Cord away from heat, oil, sharp edges, or moving parts. Replace damaged Power Cords immediately.** Damaged Power Cords increase the risk of electric shock.
9. **When operating a power tool outside, use an outdoor extension cord marked “W-A” or “W”.** These extension cords are rated for outdoor use, and reduce the risk of electric shock.

## PERSONAL SAFETY

10. **Stay alert. Watch what you are doing, and use common sense when operating a power tool. Do not use a power tool while tired or under the influence of drugs, alcohol, or medication.** A moment of inattention while operating power tools may result in serious personal injury.
11. **Dress properly. Do not wear loose clothing or jewelry. Contain long hair. Keep your hair, clothing, and gloves away from moving parts.** Loose clothes, jewelry, or long hair can be caught in moving parts.
12. **Avoid accidental starting. Be sure the Power Switch is off before plugging**

**in.** Carrying power tools with your finger on the Power Switch, or plugging in power tools with the Power Switch on, invites accidents.

13. **Remove adjusting keys or wrenches before turning the power tool on.** A wrench or a key that is left attached to a rotating part of the power tool may result in personal injury.
14. **Do not overreach. Keep proper footing and balance at all times.** Proper footing and balance enables better control of the power tool in unexpected situations.
15. **Use safety equipment. Always wear eye protection.** Dust mask, non-skid safety shoes, hard hat, or hearing protection must be used for appropriate conditions.

### TOOL USE AND CARE



16. **Use clamps (not included) or other practical ways to secure and support the workpiece to a stable platform.** Holding the work by hand or against your body is unstable and may lead to loss of control.
17. **Do not force the tool. Use the correct tool for your application.** The correct tool will do the job better and safer at the rate for which it is designed.
18. **Do not use the power tool if the Power Switch does not turn it on or off.** Any tool that cannot be controlled with the Power Switch is dangerous and must be replaced.
19. **Disconnect the Power Cord Plug from the power source before making any adjustments, changing accessories, or storing the tool.** Such preventive safety measures reduce the risk of starting the tool accidentally.
20. **Store idle tools out of reach of children and other untrained persons.** Tools are dangerous in the hands of untrained users.
21. **Maintain tools with care. Keep cutting tools sharp and clean.** Properly maintained tools with a sharp cutting edge are less likely to bind and are easier to control. Do not use a damaged tool. Tag damaged tools "Do not use" until repaired.
22. **Check for misalignment or binding of moving parts, breakage of parts, and any other condition that may affect the tool's operation. If damaged, have the tool serviced before using.** Many accidents are caused by poorly maintained tools.
23. **Use only accessories that are recommended by the manufacturer for your**



**model.** Accessories that may be suitable for one tool may become hazardous when used on another tool.

### SERVICE



24. **Tool service must be performed only by qualified repair personnel.** Service or maintenance performed by unqualified personnel could result in a risk of injury.
25. **When servicing a tool, use only identical replacement parts. Follow instructions in the “*Inspection, Maintenance, And Cleaning*” section of this manual.** Use of unauthorized parts or failure to follow maintenance instructions may create a risk of electric shock or injury.

### SPECIFIC SAFETY RULES

1. **Always use the Wheel Guard (4) with the Angle Grinder.** The Guard protects the operator from broken grinding wheel fragments.
2. **Hold the tool by its insulated gripping surfaces when performing an operation where the cutting tool may contact hidden wiring or its own cord.** Contact with a “live” wire will make exposed metal parts of the tool “live” and shock the operator.
3. **Maintain labels and nameplates on the Angle Grinder.** These carry important information. If unreadable or missing, contact Harbor Freight Tools for a replacement.
4.  **Always wear ANSI-approved safety impact eye goggles and heavy work gloves when using the Angle Grinder.** Using personal safety devices reduce the risk for injury. Safety impact eye goggles and heavy work gloves are available from Harbor Freight Tools.
5. **Maintain a safe working environment.** Keep the work area well lit. Make sure there is adequate surrounding workspace. Always keep the work area free of obstructions, grease, oil, trash, and other debris. Do not use a power tool in areas near flammable chemicals, dusts, and vapors. Do not use this product in a damp or wet location.
6.  **WARNING! All accessories for this tool must be rated for at least 11,000 RPM.** Grinding wheels and other accessories running over the rated 11,000 RPM speed can fly apart and cause injury.
7. **When using a hand-held power tool, always maintain a firm grip on the tool with both hands to resist starting torque.**

8. **Use only 4-1/2" diameter grinding wheels** (not included) **having a 7/8" center spindle hole.** Never disable or modify the Wheel Guard (4).
9. **Avoid unintentional starting.** Make sure you are prepared to begin work before turning on the Angle Grinder.
10. **Do not force the Angle Grinder.** This tool will do the work better and safer at the speed and capacity for which it was designed. Do not force the rotating grinding wheel (not included) into the object being ground. Apply moderate pressure, allowing the grinding wheel to rotate freely without being forced.
11.  **WARNING! Never install a carbide tipped or steel circular saw blade for use on this tool. Never install a wood carving blade, carving disc with saw chain cutters, or a cutting carving disc on this tool.**
12. **For safest operation, it is recommended that only these accessories be used with this tool:** Abrasive cut-off discs and wheels, flap wheels, wire brushes, and wire wheel brushes.
13. **Never lay this tool down until the rotating grinding wheel has come to a complete stop.** The rotating grinding wheel can grab the surface and pull the tool out of your control.
14. **Never leave the Angle Grinder unattended when it is plugged into an electrical outlet.** Turn off the tool, and unplug it from the electrical outlet before leaving.
15. **Always unplug this tool from its electrical outlet before performing inspection, maintenance, or cleaning procedures.**
16.  **WARNING! Keep hands and fingers away from cutting area and rotating grinding wheel.**
17. **Before using the Angle Grinder, always check to make sure the grinding wheel** (not included) **is properly mounted and is not cracked or dull.**
18. **Industrial applications must follow OSHA guidelines.**
19. **The grinding wheel** (not included) **will become hot while cutting.** Allow the grinding wheel to completely cool before handling.
20. **To avoid accidental injury, always wear heavy duty work gloves when changing the grinding wheel.**
21.  **WARNING! Some dust created by power sanding, sawing, grinding, drilling,**

and other construction activities, contain chemicals known (to the State of California) to cause cancer, birth defects or other reproductive harm. Some examples of these chemicals are: lead from lead-based paints, crystalline silica from bricks and cement or other masonry products, arsenic and chromium from chemically treated lumber. Your risk from these exposures varies, depending on how often you do this type of work. To reduce your exposure to these chemicals: work in a well ventilated area, and work with approved safety equipment, such as those dust masks that are specially designed to filter out microscopic particles. (California Health & Safety Code 25249.5, et seq.)

22.  **WARNING!** People with pacemakers should consult their physician(s) before using this product. Operation of electrical equipment in close proximity to a heart pacemaker could cause interference or failure of the pacemaker.
23.  **WARNING!** The warnings and cautions discussed in this manual cannot cover all possible conditions and situations that may occur. It must be understood by the operator that common sense and caution are factors which cannot be built into this product, but must be supplied by the operator.

## SAVE THESE INSTRUCTIONS

### GROUNDING

#### **WARNING!**

**Improperly connecting the grounding wire can result in the risk of electric shock. Check with a qualified electrician if you are in doubt as to whether the outlet is properly grounded. Do not modify the power cord plug provided with the tool. Never remove the grounding prong from the plug. Do not use the tool if the power cord or plug is damaged. If damaged, have it repaired by a service facility before use. If the plug will not fit the outlet, have a proper outlet installed by a qualified electrician.**

### GROUNDING TOOLS: TOOLS WITH THREE PRONG PLUGS

1. Tools marked with "Grounding Required" have a three wire cord and three prong grounding plug. The plug must be connected to a properly grounded outlet. If the tool should electrically malfunction or break down, grounding provides a low resistance path to carry electricity away from the user, reducing the risk of electric shock. **(See Figure A, next page.)**
2. The grounding prong in the plug is connected through the green wire inside the cord to the grounding system in the tool. The green wire in the cord must be the only wire connected to the tool's grounding system and must never be attached



to an electrically “live” terminal. **(See Figure A.)**

3. Your tool must be plugged into an appropriate outlet, properly installed and grounded in accordance with all codes and ordinances. The plug and outlet should look like those in the following illustration. **(See Figure A.)**

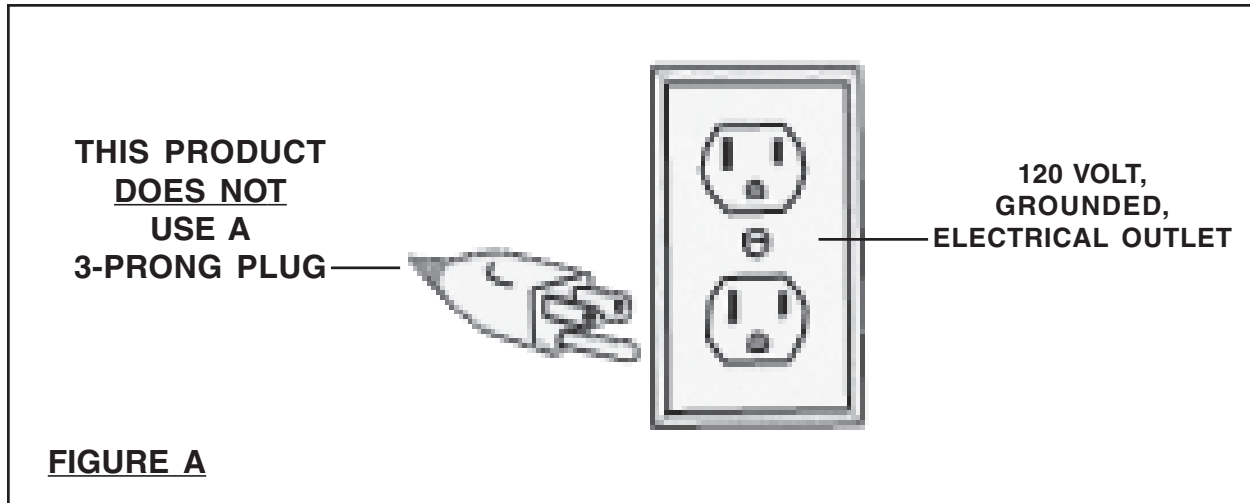

#### **DOUBLE INSULATED TOOLS: TOOLS WITH TWO PRONG PLUGS**

4. Tools marked “Double Insulated” do not require grounding. They have a special double insulation system which satisfies OSHA requirements and complies with the applicable standards of Underwriters Laboratories, Inc., the Canadian Standard Association, and the National Electrical Code. **(See Figure B.)**
5. Double insulated tools may be used in either of the 120 volt outlets shown in the following illustration. **(See Figure B.)**

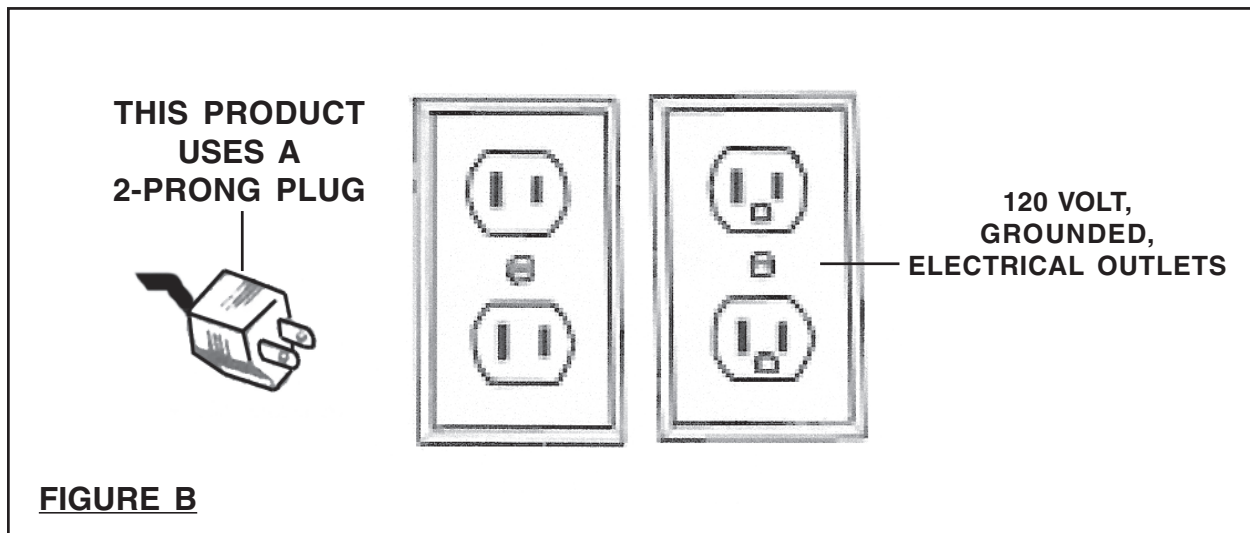









## EXTENSION CORDS

1. **Grounded** tools require a three wire extension cord. **Double Insulated** tools can use either a two or three wire extension cord.
2. As the distance from the supply outlet increases, you must use a heavier gauge extension cord. Using extension cords with inadequately sized wire causes a serious drop in voltage, resulting in loss of power and possible tool damage. **(See Figures C.)**
3. The smaller the gauge number of the wire, the greater the capacity of the cord. For example, a 14 gauge cord can carry a higher current than a 16 gauge cord. **(See Figures C.)**
4. When using more than one extension cord to make up the total length, make sure each cord contains at least the minimum wire size required. **(See Figures C.)**
5. If you are using one extension cord for more than one tool, add the nameplate amperes and use the sum to determine the required minimum cord size. **(See Figures C.)**
6. If you are using an extension cord outdoors, make sure it is marked with the suffix "W-A" ("W" in Canada) to indicate it is acceptable for outdoor use.
7. Make sure your extension cord is properly wired and in good electrical condition. Always replace a damaged extension cord or have it repaired by a qualified electrician before using it.

<b>RECOMMENDED MINIMUM WIRE GAUGE FOR EXTENSION CORDS*</b> <b>(120 VOLT)</b>					
<b>NAMEPLATE AMPERES (At Full Load)</b>	<b>EXTENSION CORD LENGTH</b>				
	<b>25 Feet</b>	<b>50 Feet</b>	<b>75 Feet</b>	<b>100 Feet</b>	<b>150 Feet</b>
<b>0 – 2.0</b>	<b>18</b>	<b>18</b>	<b>18</b>	<b>18</b>	<b>16</b>
<b>2.1 – 3.4</b>	<b>18</b>	<b>18</b>	<b>18</b>	<b>16</b>	<b>14</b>
<b>3.5 – 5.0</b>	<b>18</b>	<b>18</b>	<b>16</b>	<b>14</b>	<b>12</b>
<b>5.1 – 7.0</b>	<b>18</b>	<b>16</b>	<b>14</b>	<b>12</b>	<b>12</b>
<b>7.1 – 12.0</b>	<b>18</b>	<b>14</b>	<b>12</b>	<b>10</b>	<b>-</b>
<b>12.1 – 16.0</b>	<b>14</b>	<b>12</b>	<b>10</b>	<b>-</b>	<b>-</b>
<b>16.1 – 20.0</b>	<b>12</b>	<b>10</b>	<b>-</b>	<b>-</b>	<b>-</b>

**FIGURE C**                      \* Based on limiting the line voltage drop to five volts at 150% of the rated amperes.

## SYMBOLOLOGY

	Double Insulated
	Canadian Standards Association
	Underwriters Laboratories, Inc.
	Volts Alternating Current
	Amperes
	No Load Revolutions per Minute (RPM)

**FIGURE D**

## UNPACKING

When unpacking, check to make sure all the parts shown on the **Parts List on page 14** are included. If any parts are missing or broken, please call Harbor Freight Tools at the number shown on the cover of this manual as soon as possible.

## ASSEMBLY INSTRUCTIONS

### NOTE:

For additional information regarding the parts listed in the following pages, refer to the **Assembly Diagram on page 14**.

1.  **CAUTION!** Always make sure the PowerSwitch (41) for the Angle Grinder is in its “**OFF**” position and the tool is unplugged from its electrical outlet prior to assembling the tool, adding any accessories, or making adjustments to the tool.

### ***To Install A Grinding Wheel:***

1. Unscrew and remove the Outer Flange Nut (1) from the Spindle (7).  
**(See Figure E, next page.)**
2. Insert the Grinding Wheel (not included) onto the Spindle (7), making sure to

install the convex (rounded outward) side of the Grinding Wheel toward the Spindle (7). **(See Figure E.)**

3. Screw the Outer Flange Nut (1) onto the Spindle (7). Depress and hold the Lock Pin (22) to keep the Spindle from turning. Then, use the provided Wrench (51) to firmly tighten the Outer Flange Nut onto the Spindle. **(See Figure E.)**

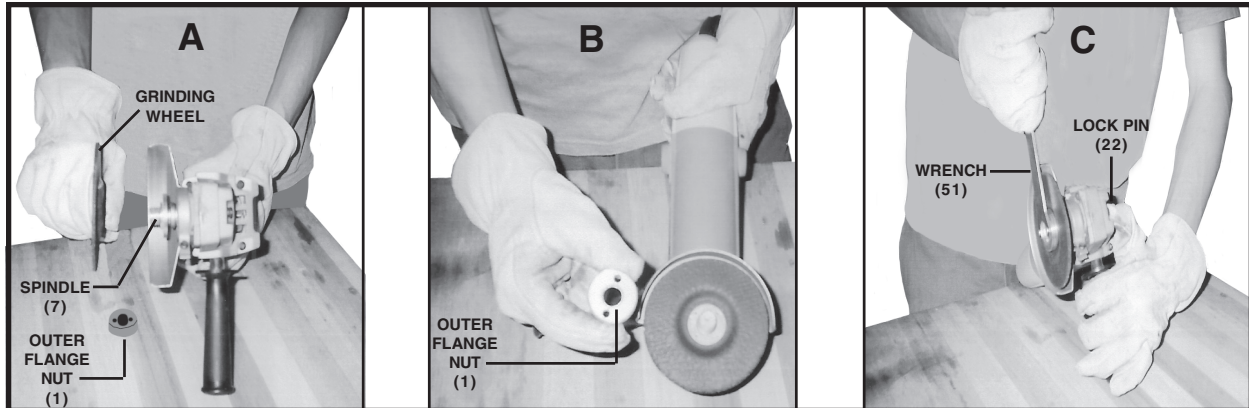

**FIGURE E**

**To Attach The Side Handle:**

1. The Side Handle (18) may be attached to either the *left* or *right* side of the Angle Grinder. **(See Figure F.)**
2. To attach the Side Handle (18) to the Angle Grinder, screw the Handle firmly into the threaded mounting hole located on either the left or right side of the Shell Head (23). **(See Figure F.)**

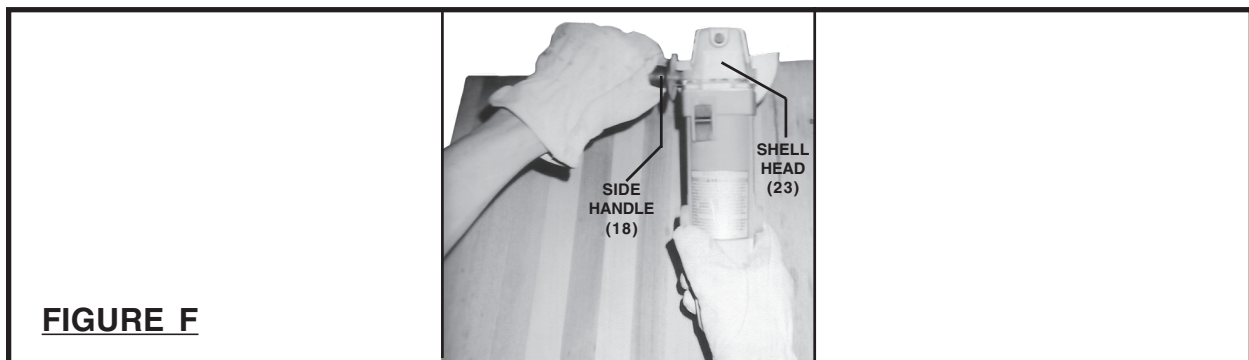
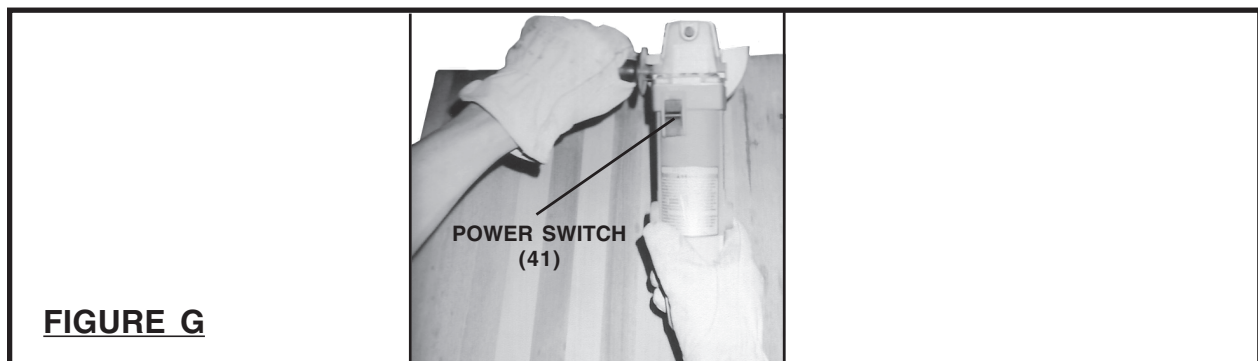

**FIGURE F**

**OPERATING INSTRUCTIONS**

1. **⚠ WARNING!** Make sure the Power Switch (41) of the Angle Grinder is in its “OFF” position before connecting the Power Cord/Plug (50) to a 120 volt, grounded, electrical outlet.

2. Grip the Angle Grinder firmly with both hands. Then turn the Power Switch (41) to its “ON” position to start the Grinder. **(See Figure G.)**
3. Hold the Angle Grinder at an angle of 10° to 15° to the work surface. When only the outer edge of the grinding wheel is used, a rough cut surface will result. If the grinding wheel is pressed flat against the workpiece, the grinding action will be irregular or bumpy and the tool will be difficult to control. **(See Figure G.)**
4. Do not force the rotating grinding wheel into the workpiece. Apply moderate pressure, allowing the grinding wheel to rotate freely without being forced. Do not attempt to exceed the maximum RPM of 11,000. **(See Figure G.)**
5. After the grinding job is completed, turn the Power Switch (41) to its “OFF” position. Then unplug the Power Cord/Plug (50) from its electrical outlet.
6. Make sure to store the Angle Grinder in a clean, dry, safe location out of reach of children and other unauthorized people.



## INSPECTION, MAINTENANCE, AND CLEANING

1. **⚠ WARNING!** Always unplug this tool from its electrical outlet before performing inspection, maintenance, or cleaning procedures.
2. **Before each use, inspect the general condition of the Angle Grinder.** Check for misalignment or binding of moving parts, cracked or broken parts, damaged electrical wiring, and any other condition that may affect its safe operation. If abnormal noise or vibration occurs, have the problem corrected before further use. **Do not use damaged equipment.**
3. **Before each use, inspect the Grinding Wheel.** Using a dull Wheel will cause excessive wear on the Motor of the Grinder and will not produce a satisfactory cut. Replace with a new Grinding Wheel when needed.

4. **To clean or replace the Carbon Brushes (38):** It may become necessary to clean or replace the two Carbon Brushes when the Motor performance decreases, or stops working completely. **The Carbon Brushes are located on each side of the Motor Housing (40).** To do so, remove the two Brush Holder Covers (37). Then, remove the two Carbon Brushes from the Brush Holders (39). If the Carbon Brushes are worn down more than 1/2, replace *both* Carbon Brushes. If, however, the Carbon Brushes are just dirty they may be cleaned by rubbing them with a pencil eraser; if only cleaning is required, clean and place brushes in the same position as they were originally in. When installing the Carbon Brushes, make sure the carbon portion of the Carbon Brushes contact the Motor Armature (30), and the springs face away from the Motor. Also, make sure the springs operate freely. After cleaning or replacement, replace the Brush Holder Covers.

**NOTE: New Carbon Brushes tend to arc or spark when first used until they wear and conform to the Motor's Armature.**  
**(See Assy. Diagram.)**

5. **To clean the exterior parts of the Angle Grinder, use only a clean cloth and mild detergent. Then dry. Do not immerse any electrical part of the tool in any liquids.**
6. Make sure to store the Angle Grinder in a clean, dry, safe location out of reach of children and other unauthorized people.
7.  **CAUTION! All maintenance, service, or repairs not mentioned in this manual must only be performed by a qualified service technician.**

## TROUBLESHOOTING

Problem	Possible Solution
Angle Grinder will not turn on.	1. Make sure tool is plugged into a working 120 volt, grounded, electrical outlet. 2. Make sure the Power Switch is in its "ON" position. 3. Unplug tool from its electrical outlet. Check both Carbon Brushes for excessive wear or excessive dirt and debris. If necessary, replace or clean both Carbon Brushes. 4. Have a qualified service technician check out the tool.
Angle Grinder runs, but a rough cut surface results when grinding the workpiece.	1. Make sure to hold the tool at an angle of 10 to 15 degrees to the work surface. 2. Check the grinding wheel for dullness, cracks, and other damage. If necessary, replace the grinding wheel.
Angle Grinder runs, but the grinding action is irregular or bumpy and the tool is difficult to control.	1. Make sure to hold the tool at an angle of 10 to 15 degrees to the work surface.
The Power Switch does not turn the Angle Grinder off.	1. Immediately disconnect the Power Cord/Plug from its electrical outlet and discontinue using the tool. Then have a qualified service technician check out the tool.

## PARTS LIST AND ASSEMBLY DIAGRAM

Part #	Description	Part #	Description	Part #	Description
1	Outer Flange Nut	18	Side Handle	35	Spring
2	Spring Washer	19	Screw	36	Wind Shield Ring
3	Inner Flange	20	Keeper	37	Brush Holder Cover
4	Wheel Guard	21	Lock Spring	38	Carbon Brush (#100, Qty. 2)
5	Screw	22	Lock Pin	39	Brush Holder (#100)
6	Nut	23	Shell Head	40	Motor Housing
7	Spindle	24	Pinion Gear	41	Power Switch
8	Woodruff Key	25	Bearing 6018	42	Switch Mount
9	Screw	26	Gearbox Back Cover	43	Screw
10	Spring Washer	27	Spring Washer	44	Switch
11	Flat Washer	28	Screw	45	End Cap Housing
12	Gearbox Bottom Cover	29	Woodruff Key	46	Screw
13	Bearing 60201	30	Armature	47	Sheath (#115A)
14	Locking Ring	31	Bearing 6018	48	Power Cord Bracket
15	Ring Gear	32	Bearing Cover	49	Self Tapping Screw
16	Locking Ring	33	Bolt	50	Power Cord/Plug
17	Bearing	34	Stator	51	Wrench

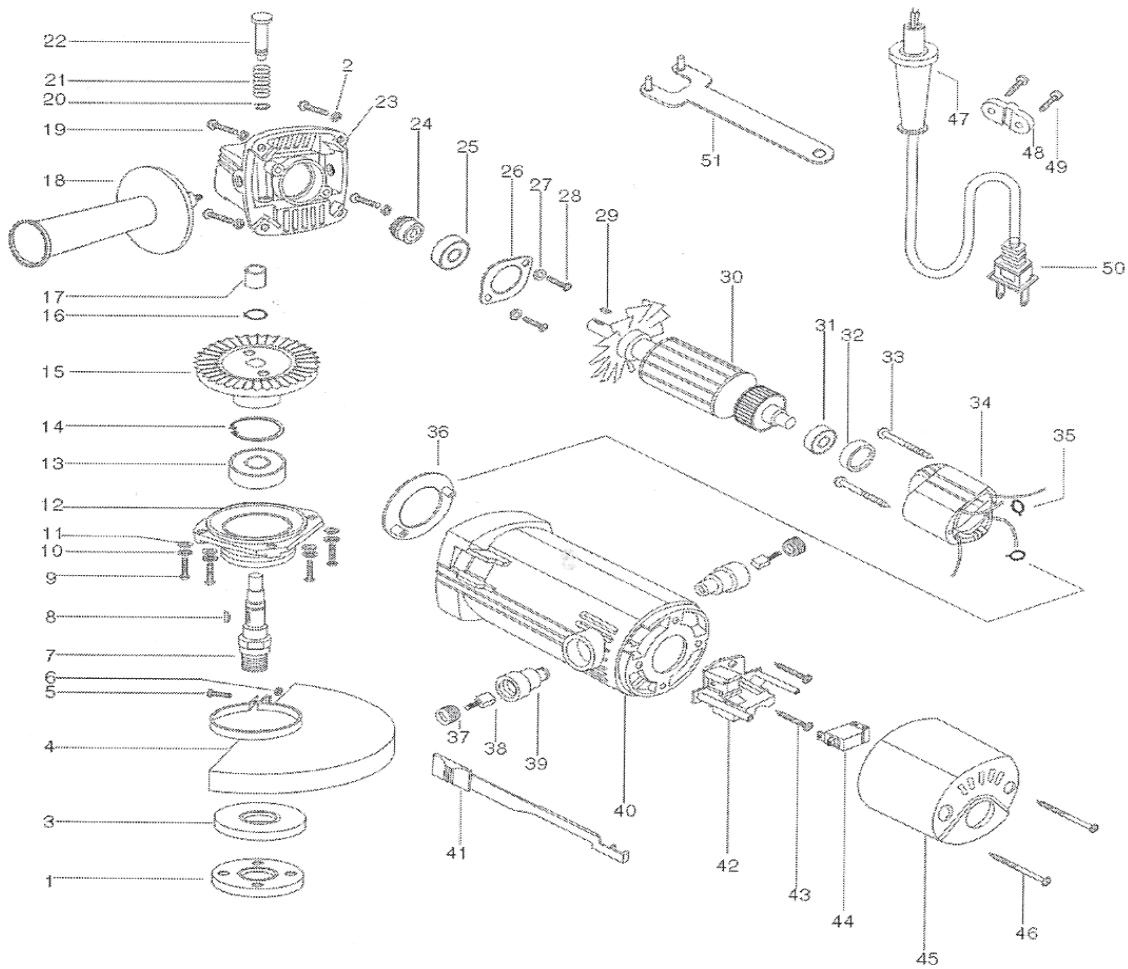

**NOTE:**  
Some parts are listed and shown for illustration purposes only,  
and are not available individually as replacement parts.



## IMPORTANT WARRANTY INFORMATION



**DM<sup>®</sup> DRILL MASTER** **LIMITED 90 DAY WARRANTY**

Harbor Freight Tools Co. makes every effort to assure that its products meet high quality and durability standards, and warrants to the original purchaser that this product is free from defects in materials and workmanship for the period of ninety days from the date of purchase. This warranty does not apply to damage due directly or indirectly, to misuse, abuse, negligence or accidents, repairs or alterations outside our facilities, or to lack of maintenance. We shall in no event be liable for death, injuries to persons or property, or for incidental, contingent, special or consequential damages arising from the use of our product. Some states do not allow the exclusion or limitation of incidental or consequential damages, so the above limitation of exclusion may not apply to you. **THIS WARRANTY IS EXPRESSLY IN LIEU OF ALL OTHER WARRANTIES, EXPRESS OR IMPLIED, INCLUDING THE WARRANTIES OF MERCHANTABILITY AND FITNESS.**

To take advantage of this warranty, the product or part must be returned to us with transportation charges prepaid. Proof of purchase date and an explanation of the complaint must accompany the merchandise. If our inspection verifies the defect, we will either repair or replace the product at our election or we may elect to refund the purchase price if we cannot readily and quickly provide you with a replacement. We will return repaired products at our expense, but if we determine there is no defect, or that the defect resulted from causes not within the scope of our warranty, then you must bear the cost of returning the product.

This warranty gives you specific legal rights and you may also have other rights which vary from state to state.

**3491 Mission Oaks Blvd. • PO Box 6009 • Camarillo, CA 93011 • (800) 444-3353**



## Free Manuals Download Website

<http://myh66.com>

<http://usermanuals.us>

<http://www.somanuals.com>

<http://www.4manuals.cc>

<http://www.manual-lib.com>

<http://www.404manual.com>

<http://www.luxmanual.com>

<http://aubethermostatmanual.com>

Golf course search by state

<http://golfingnear.com>

Email search by domain

<http://emailbydomain.com>

Auto manuals search

<http://auto.somanuals.com>

TV manuals search

<http://tv.somanuals.com>