

HD 710

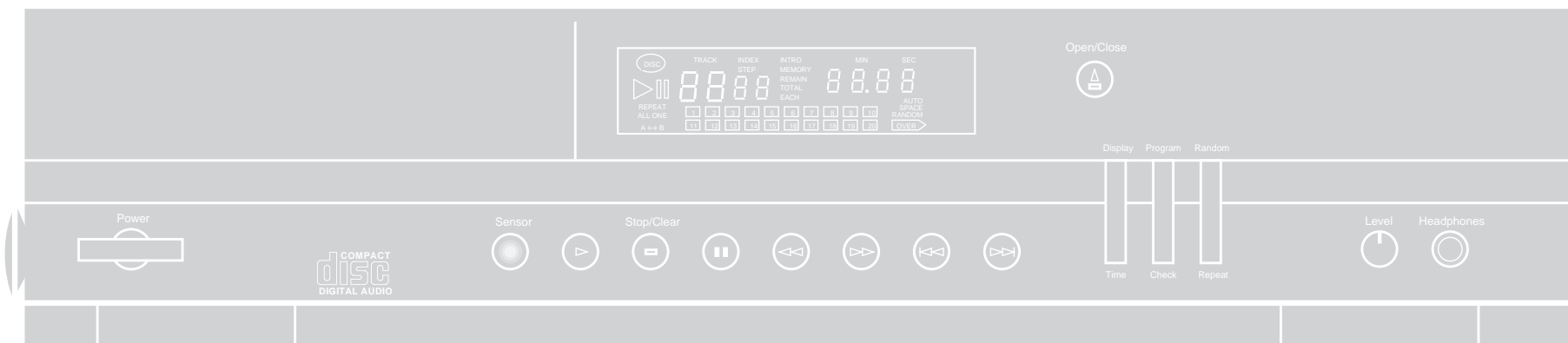

■ **harman/kardon**

Compact Disc Player
CD-Spieler
Lecteur de compact-disques
Reproductor de CD
CD-speler





OWNER'S MANUAL
BEDIENUNGSANLEITUNG
MODE D'EMPLOI
MANUAL DEL USUARIO
GEBRUIKSAANWIJZING

Lettore di Compact Disc
Compact Disc Player
Compact Disc Player
CD Player

ISTRUZIONI PER L'USO
Bruksanvisning
KÄYTTÖOPAS
ΟΔΗΓΙΕΣ ΧΡΗΣΗΣ

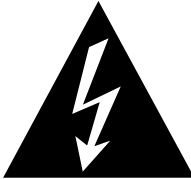

ENGLISH

	CAUTION RISK OF ELECTRIC SHOCK DO NOT OPEN	
CAUTION: TO REDUCE THE RISK OF ELECTRIC SHOCK, DO NOT REMOVE COVER (OR BACK). NO USER-SERVICEABLE PARTS INSIDE. REFER SERVICING TO QUALIFIED SERVICE PERSONNEL.		
	The lightning flash with arrowhead symbol, within an equilateral triangle, is intended to alert the user to the presence of uninsulated "dangerous voltage" within the product's enclosure that may be of sufficient magnitude to constitute a risk of electric shock to persons.	
The exclamation point within an equilateral triangle is intended to alert the user to the presence of important operating and maintenance (servicing) instructions in the literature accompanying the appliance.		
WARNING: TO REDUCE THE RISK OF FIRE OR ELECTRIC SHOCK, DO NOT EXPOSE THIS APPLIANCE TO RAIN OR MOISTURE.		

Thank you for choosing a Harman Kardon compact disc player. This is a superb piece of high fidelity equipment that has been meticulously designed to provide you with thousands of hours of enjoyment.

To appreciate the full performance of this sophisticated unit, please be sure to read this owner's manual and use your CD player only in accordance with its instructions. Keep the manual in a safe place for future reference.

CLASS 1 LASER PRODUCT

Product complies with DHHS rules CFR subchapter J part 1040:10 at date of manufacture.

DANGER: Invisible laser radiation when opened and interlock failed or defeated. Avoid direct exposure to the beam.

FCC Information for 120V Only

This equipment has been tested and found to comply within the limits for a Class B digital device, pursuant to Part 15 of the FCC Rules. These limits are designed to provide reasonable protection against harmful interference in a residential installation. This equipment generates, uses and can radiate radio frequency energy and, if not installed and used in accordance with the instructions, may cause harmful interference to radio communications. However, there is no guarantee that interference will not occur in a particular installation. If this equipment does cause harmful interference to radio or television reception, which can be determined by turning the equipment off and on, the user is encouraged to try to correct the interference by one or more of the following measures:

- Reorient or relocate the receiving antenna.
- Increase the separation between the equipment and receiver.
- Connect the equipment into an outlet on a circuit different from that to which the receiver is connected.
- Consult the dealer or an experienced radio TV technician for help.

CAUTION: Any changes or modifications in construction of this device which are not expressly approved by the party responsible for compliance could void the user's authority to operate the equipment.

CAUTION: USE OF ALL CONTROLS, ADJUSTMENTS OR PERFORMANCE OF PROCEDURES OTHER THAN THOSE SPECIFIED HEREIN MAY RESULT IN HAZARDOUS RADIATION EXPOSURE.

TO PREVENT ELECTRIC SHOCK, MATCH WIDE BLADE OF PLUG TO WIDE SLOT, FULLY INSERT.

This digital apparatus does not exceed the Class B limits for radio noise emissions from digital apparatus as set out in the Radio Interference Regulations of the Canadian Department of Communications.

PLACEMENT

The HD710 is fully shielded and may be placed on top of or under other stereo components as long as the "feet" provide sufficient clearance for cooling of the component below. Please make sure that the HD710 receives adequate ventilation. It should always be located away from heat sources such as radiators, fireplaces, stoves, and other appliances that produce heat. Avoid placing the unit in locations that receive prolonged direct sunlight or extremely low temperatures. While your compact disc player is designed to be vibration-resistant, excessive shocks or placement too close to large speakers can cause "stuttering" or skipping. When choosing a place for your new CD player, take the same precautions you would with a turntable.

GENERAL CONNECTION HINTS

As you connect your compact disc player, carefully connect the plugs to the output jacks, being sure to push the plugs in all the way. Loose connection of a plug can cause hum or other intermittent noise. Take care to match the left and right plugs on the CD player with the left and right input jacks on the back of the receiver/preamplifier/integrated amplifier. Common practice is to use the red plug as right, and the white, gray, or black plug as left.

Do not wind the cables with the power cord; doing so may degrade the sound quality.

When you have finished connecting your HD710 to your receiver/preamplifier/integrated amplifier, plug the power cord of the CD player either into a power outlet on the back of another component, or into the power outlet in the wall.

CARE OF THE LASER PICKUP

The laser pickup that detects the music recorded on a CD is located under the compact disc drawer. The laser pickup, especially its precision lens, is particularly sensitive to dust. Keep the disc drawer closed when the unit is not in use, and do not put your hand inside the unit.

INTERFERENCE

This compact disc player uses high-frequency signals that can sometimes interfere with reception in tuners and televisions. If you start to experience reception problems after connecting and turning on your CD player, move the CD player farther away from your tuner or television set or turn the CD player off when it is not in use.

POWER CORD PROTECTION

The power cord should be routed in such a way that it is not likely to be walked on or pinched by items laying on or against it. Any power cord is susceptible to stress at the point where it joins the plug and the point where it exits from the back of the unit, so take care not to fold or bend it excessively at those points. Never pull or stretch the cord. The CD player's power cord should be unplugged from the outlet when the unit is left unused for a long period of time.

CLEANING

Use only a clean dry cloth to clean your compact disc player. Do not use solvents such as alcohol, benzine, gasoline, etc. Take care that excessive dust does not accumulate on your unit, and that objects are not dropped inside or liquids spilled into the unit.

TABLE OF CONTENTS

Front Panel Controls	3
Rear Panel Connections	5
Operation.	6
HD710 Remote Control	9
Troubleshooting Guide	11
Specifications	12

WATER AND MOISTURE

Do not operate this compact disc player around water (e.g., near a swimming pool, sink, or in a wet basement).

ABNORMAL SMELLS

If you detect an abnormal smell or smoke, immediately turn the compact disc player off and pull out the power cord. Contact your dealer or nearest Harman Kardon service center.

PACKING MATERIAL

Your box and packing material are custom designed to provide optimum protection for your compact disc player. Be sure to save the box and packing material in case you need to transport or ship the unit at some future time (e.g., service or moving).

TO OBTAIN WARRANTY SERVICE

If you require warranty service, please return the product to your dealer. If this is not possible, please call 1-800-422-8027, for information on how to obtain service or replacement. If purchased outside the United States, contact your local dealer for repair or replacement. Your bill of sale will be required to obtain warranty service and to establish date of purchase.

Front Panel Controls

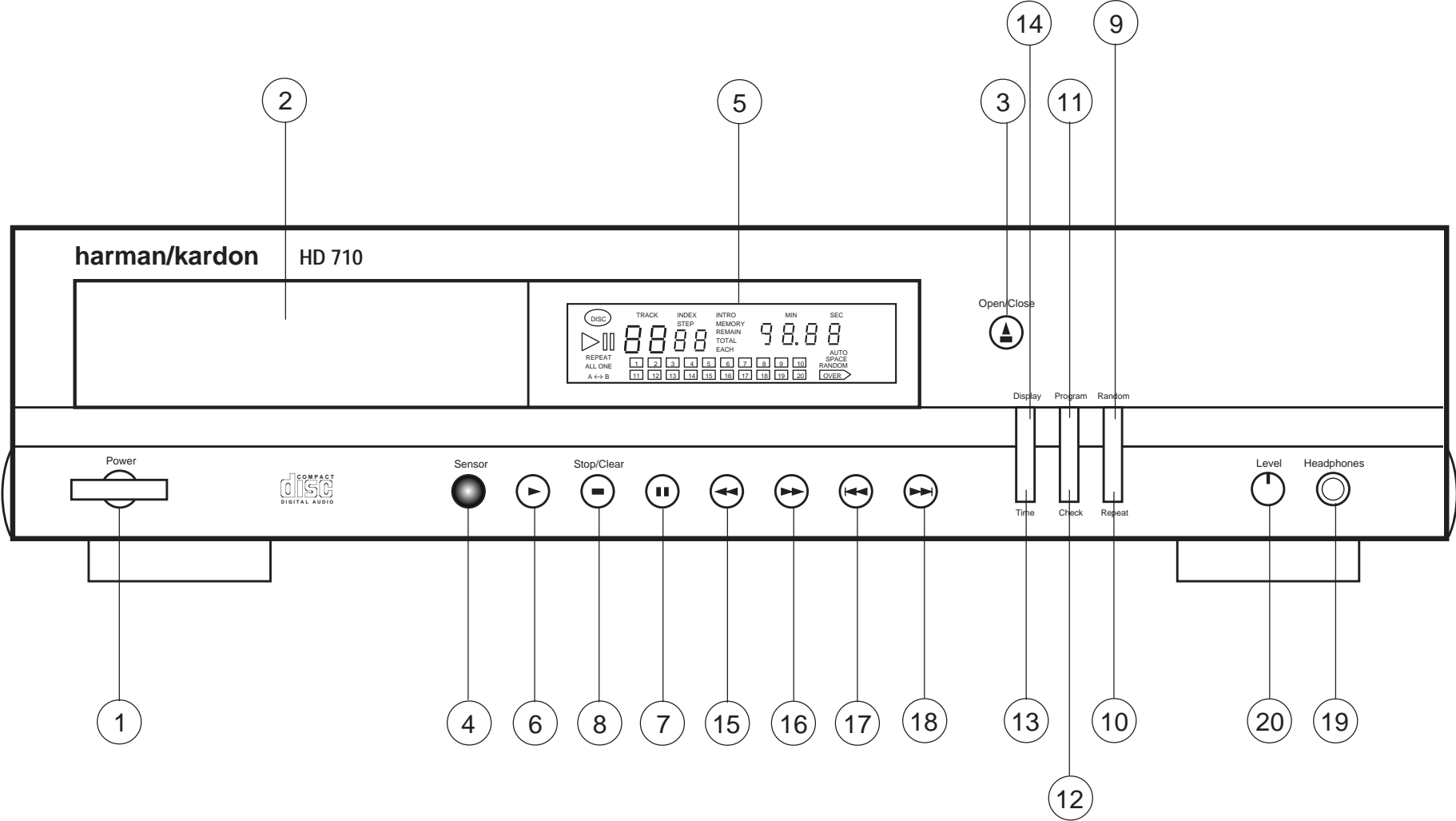

Front Panel Controls

1. POWER SWITCH

The POWER switch turns the unit on and off.

2. COMPACT DISC DRAWER

Load a disc (full-size or 3-inch/8 cm) into your compact disc player by placing it in this drawer with the label side up. Open and close the drawer using the OPEN/CLOSE button (3).

3. OPEN/CLOSE BUTTON (▲)

Press this button to open or close the compact disc drawer. The drawer will also close if you press the play button or push the drawer gently toward the chassis of the player; however, we recommend that you do not push the drawer.

4. REMOTE SENSOR

This area receives the signal from the remote control unit. Make sure this area of the front panel is kept free from dirt or other obstructions that might prevent proper reception of the infrared signal from the remote control.

5. MULTI-FUNCTION DISPLAY

This display shows the corresponding information according to each mode.

6. PLAY BUTTON (▶)

This button is used for starting play.

7. PAUSE BUTTON (||)

This button is used for holding play at the start of a track or interrupting play.

8. STOP/CLEAR BUTTON (■)

This button is used for stopping play or clearing programmed tracks.

9. RANDOM PLAY BUTTON

This button is used for playing the tracks on a disc in random order.

10. REPEAT BUTTON

This button is used for repeating one track or all tracks.

11. PROGRAM BUTTON

This button is used for storing the tracks in the Program mode.

12. PROGRAM/CHECK BUTTON

This button is used for checking the stored tracks.

13. TIME BUTTON

This button is used for checking the elapsed playing time from the beginning of current track or remaining playing time of current track or remaining playing time of disc.

14. DISPLAY BUTTON

This button is used to dim the display lighting, if desired.

15. BACKWARD SEARCH BUTTON (◀◀)

This button is used for searching for a particular passage in fast reverse.

16. FORWARD SEARCH BUTTON (▶▶)

This button is used for searching for a particular passage in fast forward.

17. BACKWARD SKIP BUTTON (◀◀)

This button is used for replaying from the beginning of the current track or returning to a previous track.

18. FORWARD SKIP BUTTON (▶▶)

This button is used for moving onto the next track.

19. HEADPHONE JACK

This JACK is used for listening with headphones.

20. HEADPHONE VOLUME

This is used for the adjustment of the headphone listening level.

ENGLISH

Rear Panel Connections

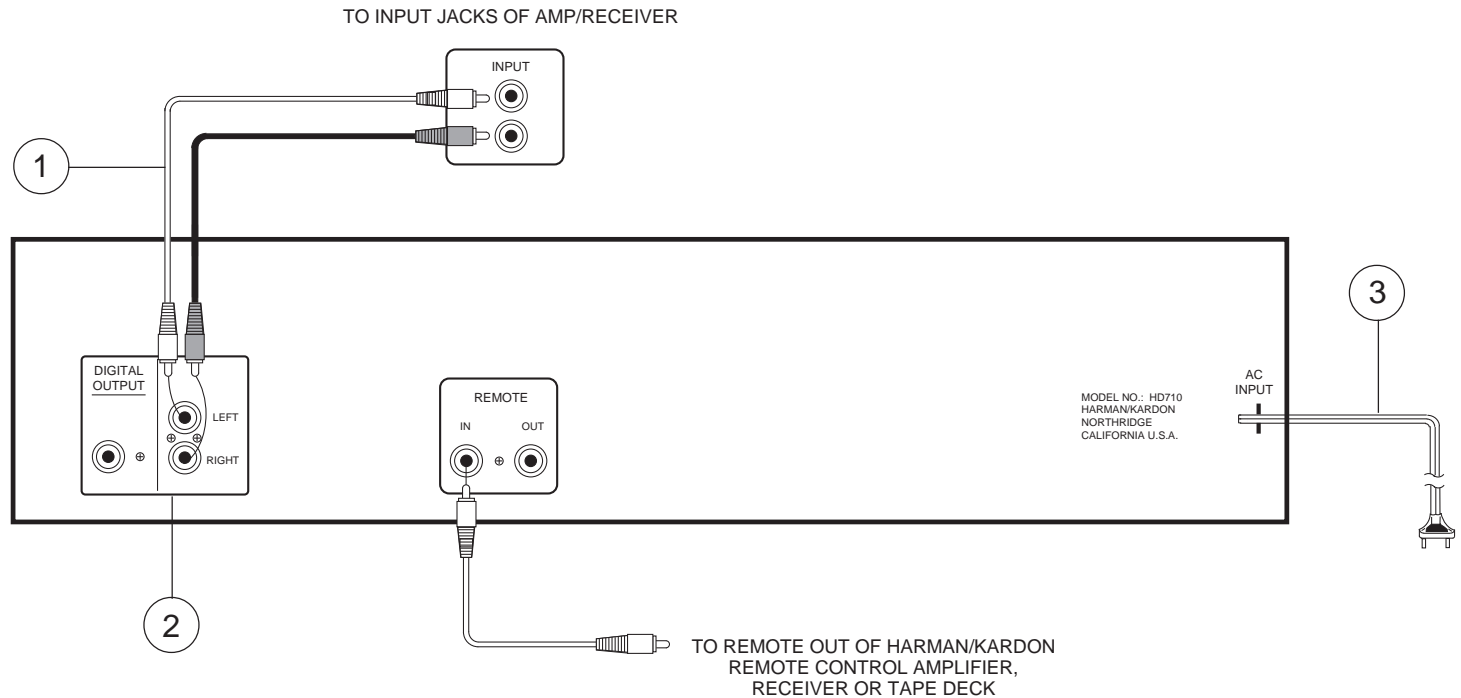

- Before you begin to connect this unit to your system, be sure that all components are turned off and unplugged from the electrical outlet.
- See the connection diagram in the operating instruction manual of a Harman/Kardon compatible amplifier or receiver.

1. CONNECTION CORDS

On the back of your HD710 are output jacks that connect your CD player to your receiver, integrated amplifier, or preamplifier. Using the supplied shielded cords, connect the left and right output jacks on the back of the CD player to the left and right input jacks marked CD or AUX on the back of your receiver/preamplifier/integrated amplifier. Alternatively, you can also use the TAPE INPUT or TAPE PLAY jacks on your receiver/preamplifier/integrated amplifier.

Note: NEVER connect your CD player to the PHONO inputs.

2. OPTIONAL DIGITAL CONNECTION

The HD710 also has a digital output jack — a single electrical RCA-type connector. If your preamplifier has a digital-to-analog decoder and can accept a digital signal from a compact disc player, you can connect your CD player to your preamplifier using this digital jack.

Please note that using the digital output will bypass the internal D/A conversion circuitry and therefore miss one of the major benefits of this machine. The best use of this output is for direct connection to a digital recorder, a very high performance external D/A Converter, or a true Digital Signal Processing (DSP) Preamplifier.

3. AC INPUT CORD

Plug this cord into the AC outlet of amplifier or receiver or a household AC outlet.

Operation

LOADING AND UNLOADING

- Press the OPEN/CLOSE button. The disc tray slides out automatically.
- Take care that the tray is not obstructed. If it is obstructed in opening, it will be closed after about five seconds. If it is obstructed in closing, it will be opened automatically after about five seconds.
- Load a disc with the labelled side up after the disc tray is opened completely.

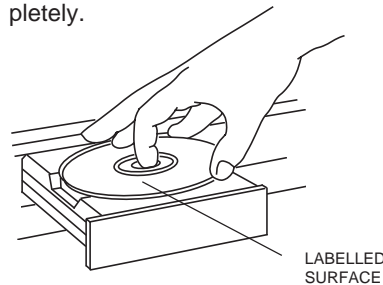

- If you want to take a disc out of the tray, press the OPEN/CLOSE button.
- Remove a disc from the tray in the same way as loading to avoid leaving fingerprints on the disc surface.
- After putting a disc into its storage case, close the disc tray by pressing the OPEN/CLOSE button.

CAUTION IN LOADING AND UNLOADING

- Do not tilt the unit while the disc tray is opening or closing because the disc could fall off.

- Do not insert any objects into the tray as it can damage the mechanism.
- To prevent dirt and dust from entering the mechanism, do not leave the disc tray open.

NORMAL PLAY

PLAYING A DISC

- Press the POWER switch to turn the unit on.
- Open the disc tray, load a disc and close it.
- The display shows the total number of the tracks and the total playing time of the disc, and the music calendar displays the number of tracks. When the total number of tracks is more than 19, **OVER** will appear next to 19 as indicated below.

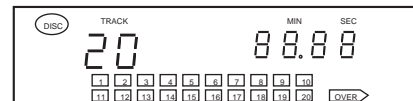

STOP MODE

- Press the PLAY button. Play starts and the first track number, elapsed playing time, and ► appear in the display.
- After the last track has been played the unit switches to the stop mode.

INTERRUPTING PLAY (PAUSE MODE)

- Press the PAUSE button to temporarily interrupt play. The disc continues to spin but the sound stops, and **||** appears on the display. To continue playing, press the PLAY or PAUSE button again.

STOPPING PLAY (STOP MODE)

- Press the STOP/CLEAR button to stop play before the end of the disc is reached.

MUSIC SEARCH OPERATION

SKIP

SELECTING A HIGHER NUMBERED TRACK IN PLAY MODE

- Press the FORWARD SKIP button (►►) to advance to the beginning of the next track.
- During normal play, if the FORWARD SKIP button is pressed when playing the last track, the last track is skipped to the first track.
- During random or programmed play, if the FORWARD SKIP button is pressed when playing the last track, the "End" sign appears on the display and the last track continues to be played.

SELECTING A PREVIOUS TRACK IN PLAY MODE

- If a track is playing, press the BACKWARD SKIP BUTTON (◄◄) to return to the beginning of the track.
- Press the BACKWARD SKIP button before a track begins playing to move to the beginning of the previous track.
- During normal play, if the BACKWARD SKIP button is pressed at the beginning of the first track, the first track is skipped to the last track.
- During random or programmed play, the BACKWARD SKIP button can be pressed only to return to the beginning of the first track.

BEGINNING AT A SPECIFIC TRACK IN STOP MODE

1. Repeatedly press the FORWARD or BACKWARD SKIP button (►►/◄◄) until the desired track number appears on the display.



2. Press the PLAY button

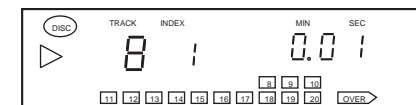

SEARCH

SEARCHING A SPECIFIC PASSAGE IN PLAY MODE

- Press and hold down the FORWARD or BACKWARD SEARCH button (▶▶/◀◀) and release the button when the desired point has been reached.
- If the CD player reaches the end of the last track during forward search, the unit switches to the stop mode.
- If the CD player reaches the beginning of a CD during backward search in normal play mode, play restarts at this point.

If the CD player reaches the beginning of a track during backward search in random or programmed play mode, play restarts at this point.

REPEAT PLAY

REPEAT ALL TRACKS

- Press the REPEAT button before or during play.
- REPEAT [ALL] appears on the display and all tracks of the CD will be repeated.
- If the CD player reaches the end of the last track during forward search, the unit goes back to the beginning of the first track and continues to search forward.

REPEAT ONE TRACK

- After selecting a desired track with the FORWARD or BACKWARD SKIP button, press the REPEAT button twice before or during play.
- REPEAT [ONE] appears on the display and the selected track will be repeated.
- If the REPEAT button is pressed once again in this mode, repeat play mode is canceled.

PROGRAMMED PLAY

You can program up to 20 tracks to play in any sequence you choose.

If you exceed 20 tracks, the "Full" sign appears to remind you that the memory is full and cannot accept any more tracks.

PROGRAMMING

Example: If you wish to program the tracks 4, 8 and 17, the programming procedure is as follows.

1. In the stop mode, press the PROGRAM button, the MEMORY light in the display will start blinking.

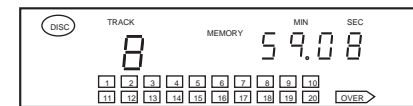

2. Select the desired track with the SKIP buttons or NUMERIC buttons on the remote.

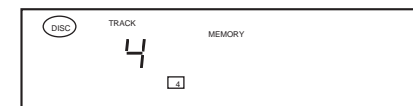

3. Press the PROGRAM button. The TOTAL light and the program number (1-20) in the display will illuminate.

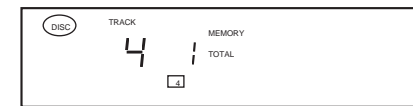

4. Repeat steps 2 and 3 to complete programming.

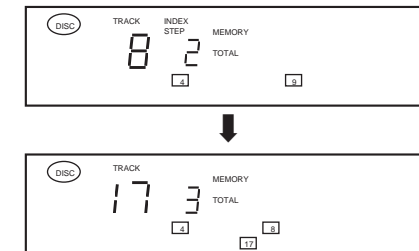

5. Press the PLAY button.

- After the last programmed track has been played, the last programmed track number and the total playing time of the programmed tracks are shown on the display.
- During program play, if you want normal play, select the desired track with the NUMERIC buttons, then normal play will start that track.
- If you want program play again, press the PROGRAM button in the stop mode, then the unit switches to the program mode.



CHECKING THE CONTENTS OF THE PROGRAM

You can check the contents of the program during programming or after completion of programming.

- Each time the PROGRAM/CHECK button is pressed, the programmed tracks will appear in the programmed sequence.

CLEARING THE PROGRAMMED TRACKS

- Each time the STOP/CLEAR button is pressed during programming or after completion of programming, the programmed tracks are cleared one by one in the opposite sequence.
- If you wish to clear a specific track, find that track with the PROGRAM/CHECK button and clear with the STOP/CLEAR button.
- By pressing the OPEN/CLOSE or STOP/CLEAR button over 4 seconds in the stop mode, all programmed tracks will be cleared.

RANDOM PLAY

In this mode, CD player plays the tracks on the CD in random sequence.

- Press the RANDOM PLAY button. The unit automatically selects and plays tracks at random.
- If the RANDOM PLAY button is pressed during random play, random play is canceled and normal play starts at the present track.

TIME DISPLAY SELECTION

In addition to displaying the elapsed time of the currently playing track, this unit has two other time display modes. One mode will indicate the total time remaining on the disc (TOTAL will light in the display). The other mode will indicate the time remaining on a specific track (EACH will light in the display).

- Change the time display selection by repeatedly pressing the TIME button.

NOTE:

When a track of which number is greater than 30 is programmed or being played, or during random play, the time display may show “- -: -”.

DISPLAY DIMMING

- Pressing the DISPLAY button deletes all indicators in the display, only the (selected) track indication remains in STOP or PAUSE mode.
- While running even this track indication is deleted, leaving only a small dot in the display as reminder that the unit is still running.
In that mode if any button (except PLAY) is pressed, the track is indicated again for a short moment.
- Pressing the DISPLAY button again returns to the normal display indication.

The remote control for the HD710 provides the same functions found on the front panel of the compact disc player itself. In addition, the remote control provides some functions that are not found on the front panel.

The functions found on the remote control that are not found on the front panel are INTRO, A \leftrightarrow B, and the 1-10 keys. These three functions are described below (for other functions, see the descriptions on page 4.)

1. INTRO BUTTON

This button puts your compact disc player in and out of INTRO SCAN mode. When INTRO SCAN is on and you press PLAY, the unit plays only the first 15 seconds of each track before moving on to the next. Press the button once to turn on INTRO SCAN mode; press again to turn it off and stop the scanning. When the unit is in INTRO SCAN mode, the FUNCTION indicator (5) will display the word INTRO.

Remote Control

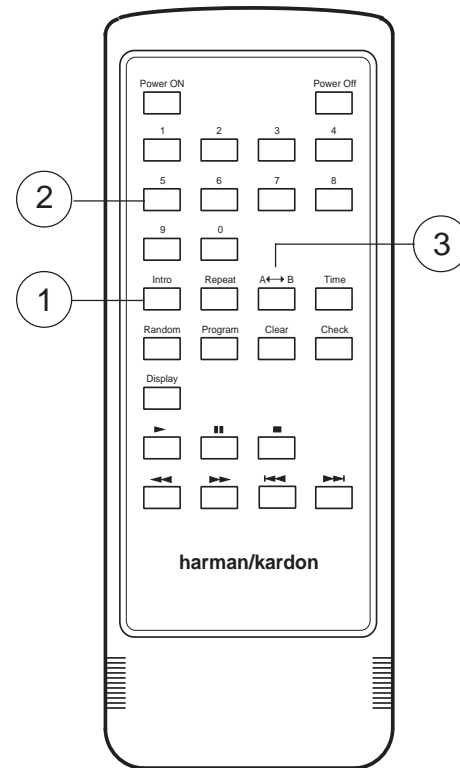

2. NUMERIC BUTTONS (0 - 9)

- If you press the number that corresponds to your desired track with the NUMERIC buttons, the unit plays that track immediately without the PLAY button.
- To select a two digit track number, the second digit must be pressed within about 2 seconds after the first digit has been pressed.
- During programming, if you select the desired track with the NUMERIC buttons, that track is programmed without the PROGRAM button.

3. A \leftrightarrow B BUTTON

- Press the A \leftrightarrow B BUTTON at the beginning of the passage you want, then REPEAT appears on the display and $\boxed{A \leftrightarrow B}$ blinks.
- Press this button again at the end of the passage, then $\boxed{A \leftrightarrow B} \boxed{B}$ appears on the display and the specific passage is being played repeatedly.
- If you want to cancel repeat A \leftrightarrow B play, press the A \leftrightarrow B or STOP/CLEAR button.

HD710 REMOTE CONTROL OPERATION

The remote control operates within a 30° angle and 23 ft. (7 m) range of the remote sensor on the front panel of the unit. Make sure that the remote's front projection "lens" as well as the REMOTE SENSOR area on the front panel of the unit are kept free from dirt to ensure proper transmission and reception of the infrared beam. Also make sure that no objects (e.g., stereo cabinet doors, end tables) block the path from the remote control to the REMOTE SENSOR area.

Avoid using the remote control near fluorescent lamps, as they may shorten its operating range.

If your remote control will sit unused for a long period of time, remove the batteries to prevent damage from corrosion.

REAR PANEL REMOTE JACKS

The remote control input jack allows remote control of this unit via a cable. This cable can be connected to the remote control output jack of another Harman Kardon product. Alternatively, it can be connected to an accessory device that converts infrared remote control signals into detected pulses. While all Harman Kardon products with remote control jacks are compatible with one another, not all accessory devices or other manufacturer's products are. However, it is safe to experiment.

CONCERNING USE OF BATTERIES

Two batteries are provided with your remote control. To load batteries:

1. Locate the cover over the battery compartment on the back of the remote control. Remove the cover by sliding it in the direction of the embossed arrow.
2. Insert the two AA (1.5V/R6/UM3) batteries. Make sure you insert the batteries according to the + and - polarity symbols at the bottom of the battery compartment.
3. Replace the cover of the battery compartment.

NOTE:

1. When you replace weak batteries, replace both at the same time.
2. Remove the batteries if the remote is not to be used for an extended period of time.
3. Do not use rechargeable batteries (Ni-Cd type).

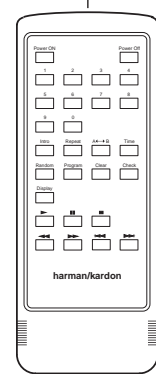
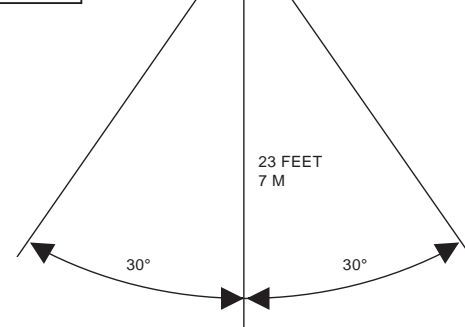
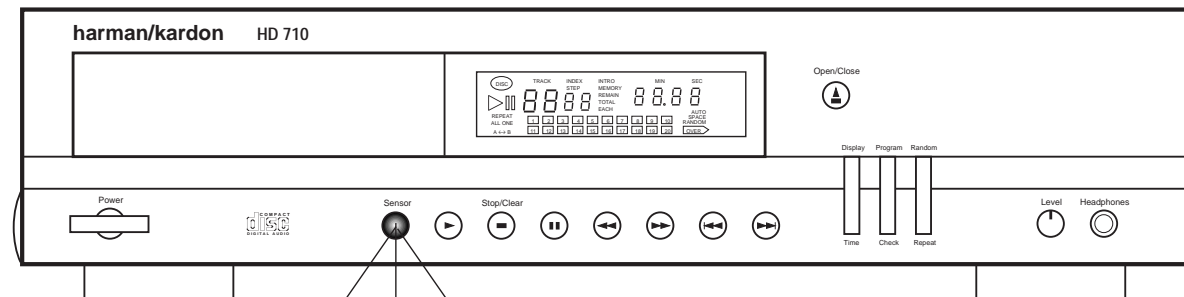

REMOTE CONTROL UNIT

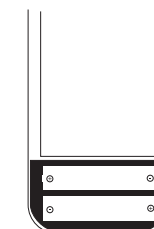
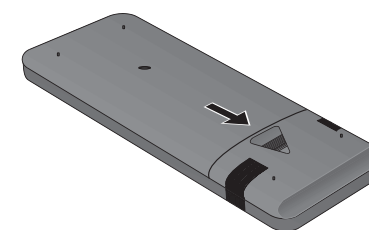

ENGLISH

Troubleshooting Guide

If your HD710 does not operate as expected, first check the items in the following list. If you cannot determine the source of the problem, contact your dealer or authorized Harman Kardon service representative.

NO LIGHTS ON THE FRONT PANEL

- Power cord is not plugged into power outlet.
- Wall outlet or extension cord is faulty. Check for poor connections.
- Breaker on plug strip has tripped. Reset breaker.

FRONT PANEL LIGHTS ARE ON, BUT THE CD DOES NOT PLAY

- The disc may have been inserted upside down. Make sure the label side is facing up.
- Moisture may have formed on the laser/receptor inside the unit. This sometimes occurs in damp climates or when the unit is moved from a cold to a warm area. Leave the unit turned on at room temperature for 30 minutes to allow the moisture to evaporate, then play your disc.

THE PLAY INDICATOR LIGHTS, BUT NO SOUND IS HEARD

- The wrong SOURCE has been selected on your integrated amplifier/receiver/preamplifier. Make sure you have selected the SOURCE where your CD player is connected.

THE SOUND SKIPS OR STUTTERS DURING PLAYBACK

- The disc may be dirty or damaged.
- The unit may have been placed on an unstable surface. Isolate the unit from excessive vibration by placing it on a firmer surface or farther away from your speakers.

THE SOUND IS CONTINUOUSLY DISTORTED

- The cables from the HD710 have been plugged into the wrong input jacks on your integrated amplifier/receiver/preamplifier. Make sure you have not plugged the unit into the PHONO jacks.

NOTHING HAPPENS WHEN FUNCTION KEYS ARE PRESSED

- Turn the power to the unit off, then back on again.

THE DISPLAY SHOWS BROKEN CHARACTERS

- Turn the power to the unit off, then back on again.

THE REMOTE CONTROL DOES NOT FUNCTION CORRECTLY

- Make sure you are using the remote control within the 30° angle and 23 ft. (7 m) range described in this manual.
- Make sure the remote transmitter lens and the front panel REMOTE SENSOR window are clean and that no objects are blocking the path from the remote control to the REMOTE SENSOR area on the front panel.
- Make sure that no strong fluorescent lights are being used in the listening room.
- Check that the batteries inside the remote control are fresh.

Specifications

• SIGNAL FORMAT	
Sampling Frequency	44.1 kHz
D/A Conversion	1 bit (Bit Stream Conversion)
Oversampling	4 times
• Discrete Analog Output Section	
Error Correction	CIRC System
Frequency Response	8 Hz to 20 kHz \pm 1.0 dB
Total Harmonic Distortion (THD)	0.005%
Dynamic Range	96 dB
Signal to Noise Ratio	100 dB
Channel Separation	95 dB
Line Output Level	2.0 V RMS
Power Consumption	18 Watts
Dimensions (W x H x D)	17 5/16 in. x 3 3/4 in. x 13 in. (440 mm x 95 mm x 330 mm)
Weight	10.1 lbs (4.6 kg)

Note: Specifications and features are subject to change without notice.

DECLARATION OF CONFORMITY



We, Harman Marketing Europe a/s
Kongevejen 194B
DK-3460 Birkerød
Danemark

declare that the product described in
this owner's manual is in compliance
with technical standards:

EN 55013/6.1990. EN 55022/4.1987
EN 60555/4. 1987

Accredited test laboratory:
MIKES PRODUCT SERVICE GmbH
Ohmstrasse 2-4
D-94342 Strasskirchen
Germany



Steen Michaelsen
harman marketing europe a/s

*The appliance conforms with EEC directive
87/308/EEC regarding interference suppression*

(For 230 V Only)

ENGLISH

Free Manuals Download Website

<http://myh66.com>

<http://usermanuals.us>

<http://www.somanuals.com>

<http://www.4manuals.cc>

<http://www.manual-lib.com>

<http://www.404manual.com>

<http://www.luxmanual.com>

<http://aubethermostatmanual.com>

Golf course search by state

<http://golfingnear.com>

Email search by domain

<http://emailbydomain.com>

Auto manuals search

<http://auto.somanuals.com>

TV manuals search

<http://tv.somanuals.com>