

HKS 3 Surround Loudspeakers

OWNER'S MANUAL



harman/kardon®

Power for the Digital Revolution®

Table of Contents

- 3 Introduction
- 4 Speaker Placement
- 5 Mounting Options
- 6 Speaker Connections
 - 6 Connection Guide
 - 6 Configuring your Receiver or Processor
- 7 Troubleshooting
- 8 Specifications

Declaration of Conformity



We, Harman Consumer International
2, Route de Tours
72500 Château-du-Loir,
FRANCE

declare in own responsibility, that the product described in this owner's manual is in compliance with technical standards:

EN 60065:1998
EN 55013/A14:1999
EN 55020/A14:1999
EN 61000-3-2/A14:2000
EN 61000-3-3/1.1995
EN 50081-1:1992
EN 50082-1:1992

Carsten Olesen
Harman Kardon Europe
01/04

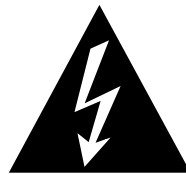

CAUTION

RISK OF ELECTRIC SHOCK
DO NOT OPEN



CAUTION: TO REDUCE THE RISK OF ELECTRIC SHOCK, DO NOT REMOVE COVER (OR BACK). NO USER-SERVICEABLE PARTS INSIDE. REFER SERVICING TO QUALIFIED SERVICE PERSONNEL.



The lightning flash with arrowhead symbol, within an equilateral triangle, is intended to alert the user to the presence of uninsulated "dangerous voltage" within the product's enclosure that may be of sufficient magnitude to constitute a risk of electric shock to persons.



The exclamation point within an equilateral triangle is intended to alert the user to the presence of important operating and maintenance (servicing) instructions in the literature accompanying the appliance.

WARNING: TO REDUCE THE RISK OF FIRE OR ELECTRIC SHOCK, DO NOT EXPOSE THIS APPLIANCE TO RAIN OR MOISTURE.

Introduction

Introduction

Thank you for purchasing the Harman Kardon HKS 3, with which you're about to begin many years of listening enjoyment. The HKS 3 has been custom-designed to provide all the excitement and power of the cinema experience in your own living room.

The HKS 3 loudspeakers are suitable for upgrading almost any 5.1 home theater system to 7.1 channels when used with a 7.1-channel receiver or processor and any necessary additional amplifiers.

To obtain maximum enjoyment from your new speakers, we urge you to take a few minutes to read through this manual. This will ensure that connections to your receiver or preamp/processor and amplifier or other external devices are made properly. In addition, a few minutes spent learning the functions of understanding the setup options will enable you to take advantage of all the power and refinement the HKS 3 is able to deliver.

If you have any questions about this product, its installation or operation, please contact your dealer, the best local source of information.

Description and Features

The HKS 3 is a pair of 2-way satellite speakers for use in a home theater system. The HKS 3 speakers are identical to the satellites in the Harman Kardon HKTS 7 system, and are designed to be used with the HKTS 7 in a complete 7.1-channel home theater. Color-coded speaker cables are included to facilitate installing the speakers in the surround back left and right positions.

Shelf stands and wall-mount brackets are included for the satellite speakers, and optional HTFS 2 floor stands are available separately from your Harman Kardon dealer.

Harman Kardon invented the high-fidelity receiver fifty years ago. With state-of-the-art features and time-honored circuit designs, the HKS 3 is a perfect complement to a Harman Kardon receiver or any home theater system.

- **Matched Pair of Loudspeakers for Use in Multichannel Applications**
- **Speakers Are Magnetically Shielded for Flexible Placement Near Video Monitors**
- **Three-Inch Driver**
- **One-Half-Inch Balanced-Dome Tweeter**
- **Metal-Wire-Mesh Grille**
- **Elegant Cabinet**
- **Shelf Stands, Wall-Mount Brackets and Color-Coded Speaker Cables Are Included**
- **May Be Used With Optional Floor Stands**

Included

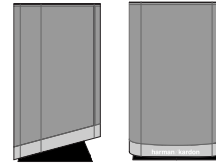

Two satellites for left, right and surrounds (shown with included shelf stands attached)

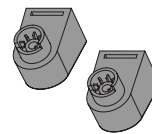

Two wall-mount brackets

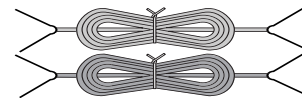

Two 12-meter speaker cables for connection from receiver to speakers.

Speaker Placement

Color-Coding System

The HKS 3 and the HKTS 7 use the channel color-coding system established by the Consumer Electronics Association to make setting up your home theater speaker system as easy as possible. Your system includes a set of colored stickers that may be placed near the speaker terminals of each of the satellite speakers. In addition, the included speaker wires have colored bands at each end to assist you in connecting them correctly. Use the brown sticker and cable for the Surround Back Left speaker, and the tan sticker and cable for the Surround Back Right speaker. Although the wires included with your HKS 3 speakers are color-coded for the Surround Back Left and Right channels, they are interchangeable with the wires supplied with the HKTS 7 system. It doesn't matter which satellite speaker is used for any of the front or rear positions. (The center speaker and powered subwoofer of the HKTS 7 are already color-coded.)

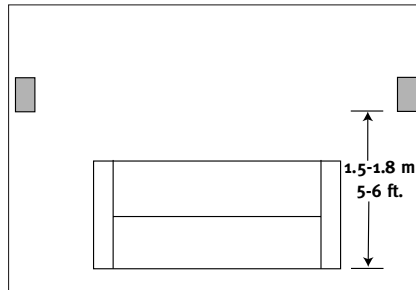
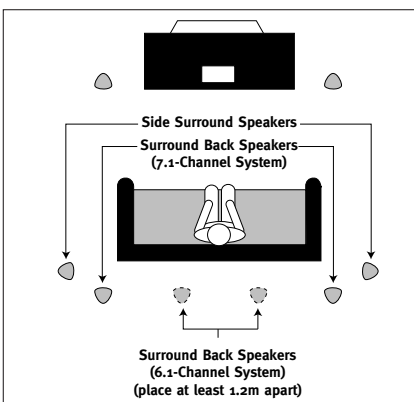
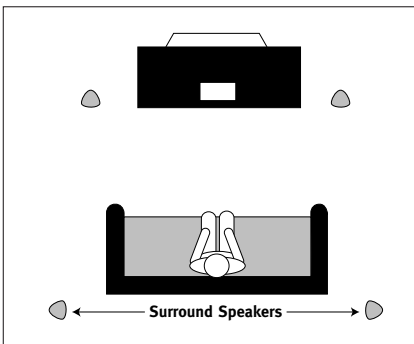
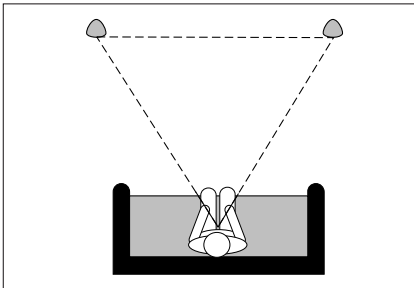

When Used as Front Speakers

Front speakers should be placed the same distance from each other as they are from the listening position. They should be placed at about the same height from the floor as the listeners' ears, or they may be angled toward the listeners.

When Used as Surround Speakers

For 5.1-channel applications, the two surround speakers should be placed slightly behind the listening position and, ideally, should face each other and be at a level higher than the listeners' ears. If that is not possible, they may be placed on a wall behind the listening position, facing forward.

In 7.1-channel systems, place the side surround speakers slightly behind the listening position, as shown in the diagram to the left. The surround back speakers should be placed on the rear wall, facing forward, the same distance apart as the main front speakers.

In 6.1-channel systems, you may use a pair of HKS 3 speakers for the surround back speakers in place of a single rear center speaker. Using two speakers will provide a more diffuse surround effect, and will also increase the total sound output for the surround back channel without overworking any individual speaker. Place the two speakers on the rear wall the same distance apart as each speaker is from the listener, but at least four feet apart.

The surround back speakers in a 6.1- or 7.1-channel system should be placed at the same height as the surround speakers, about 1.5 to 1.8 meter above the floor.

The surround speakers should not call attention to themselves. Experiment with their placement until you hear a diffuse, ambient sound accompanying the main-program material heard in the front speakers.

Satellites and Surrounds

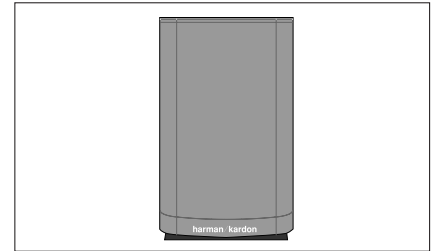

The satellite speakers may be placed on a shelf.

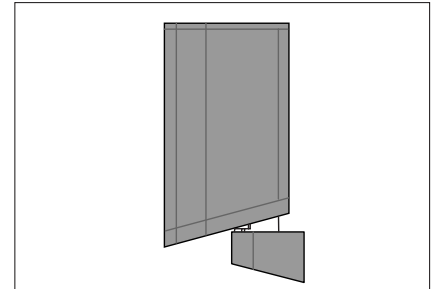

They may be wall-mounted using the supplied brackets.

Mounting Options

Wall-Mounting

Unscrew the bolt that attaches the black shelf stand to the bottom of the speaker. Store the stand and bolt in a safe place in case they are needed for a future installation.

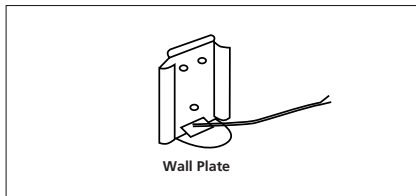
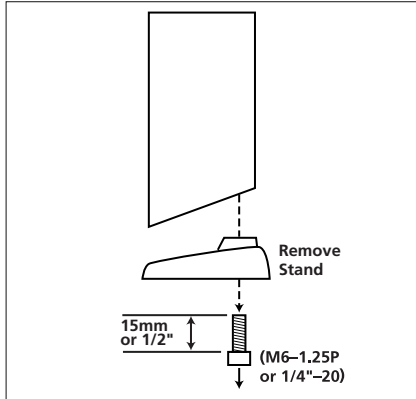

Mount the wall-bracket attachment plate on the wall in the desired location.

If possible, position the speakers so that the mounting screws (not included; use size #8) may be installed directly into a wooden wall stud. If that is not possible, use optional wall anchors that are rated to support at least twenty-five pounds. **The customer is responsible for proper selection and use of mounting hardware, available through hardware stores, to properly and safely wall-mount the speakers.**

Referring to the speaker connection instructions on page 6, thread the appropriate speaker cable through the opening in the bottom of the attachment plate, and then through the back of the bracket as shown in the diagram.

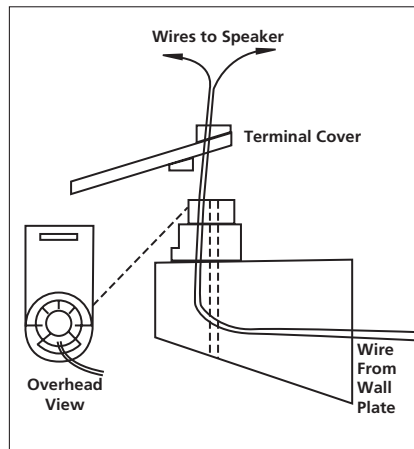

The bracket has two openings on top: a round screw hole, and an arc-shaped opening in front of it. The speaker cable should be threaded through the arc-shaped opening, not the screw hole.

Attach the bracket to the wall plate by inserting the tab at the top of the attachment plate into the slot on top of the bracket and snapping the bracket onto the attachment plate.

Thread the cable through the round opening in the terminal cover, and then insert the speaker wires into the terminals on the underside of the speaker, remembering to observe the correct polarity (see page 6).

Place the terminal cover over the opening on the underside of the speaker so that it fits flush against the speaker and covers the terminals, with its round opening exposing the threaded insert. The bracket fits through the round opening in the terminal cover.

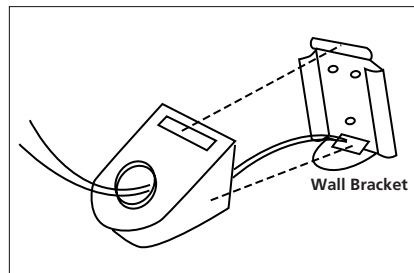

Insert the supplied bracket bolt up through the bottom of the bracket and terminal cover, and screw it into the threaded insert on the underside of the speaker. The bolt should be snug, but not so tight as to prevent the bracket from pivoting.

The wall-mounted speaker may be pivoted from side to side; however, the bracket is not designed to tilt up or down, and attempting to tilt it will damage the bracket and possibly the wall, which would not be covered by your warranty.

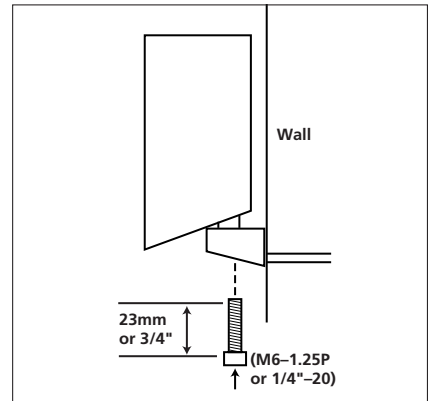

Speaker Connections

Speaker-Level Connection Guide

IMPORTANT NOTE: Before making speaker connections, be certain that your receiver or audio power amplifier is turned off and preferably unplugged from its AC power source.

Speakers and electronics terminals have corresponding (+) and (-) terminals. Most manufacturers of speakers and electronics, including Harman Kardon, use red to denote the (+) terminal and black for the (-) terminal.

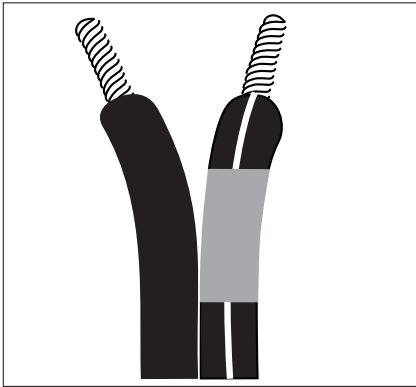

Newer Harman Kardon receivers conform to the CEA standard and therefore use a color other than red or black for the (+) terminal to indicate some speaker positions: e.g., blue for surround left positive (+). However, the black terminal will always be the negative (-) connection. Please see the owner's guide for your AVR Series receiver for further details.

Although the HKS 3 speakers may be placed in the front, side surround or surround back positions, the speaker wires provided with the system have been color-coded brown for the surround back left speaker and tan for the surround back right speaker. When used with the HKTS 7 system, it is recommended that you maintain the color-coding system for all cables to simplify setup, and to ensure that each wire in a channel pair (e.g., front left and right) is the same length as its partner.

The (+) lead of the speaker wire is indicated with a stripe and has the colored band corresponding to the speaker's position. It is important to connect all speakers identically: (+) on the speaker to (+) on the amplifier and (-) on the speaker to (-) on the amplifier. Wiring "out of phase" results in thin sound, weak bass and a poor stereo image.

With the advent of multichannel surround-sound systems, connecting all of the speakers in your system with the correct polarity remains equally important in order to preserve the proper ambience and directionality of the program material.

To connect the supplied speaker wires to the satellite speaker terminals located on the bottom of each speaker, press the red or black tab, insert the bare end of the wire into the hole, and release the tab. Gently tug on the wire to make sure that it is fully inserted.

Configuring Your Receiver or Processor

Many receivers and processors feature programmable bass-management capability, which allows the component to output the lowest frequencies (the bass information) exclusively to a separate subwoofer speaker, or to a main speaker that is capable of handling low frequencies, or sometimes to both. During the setup process you will be asked to specify whether the speaker for a given channel is "Large" or "Small." The terms "Large" and "Small" do not refer to physical size, but to the size of the frequency range the speaker is capable of handling. When configuring your receiver or processor for the channels where HKS 3 speakers are being used, select "Small."

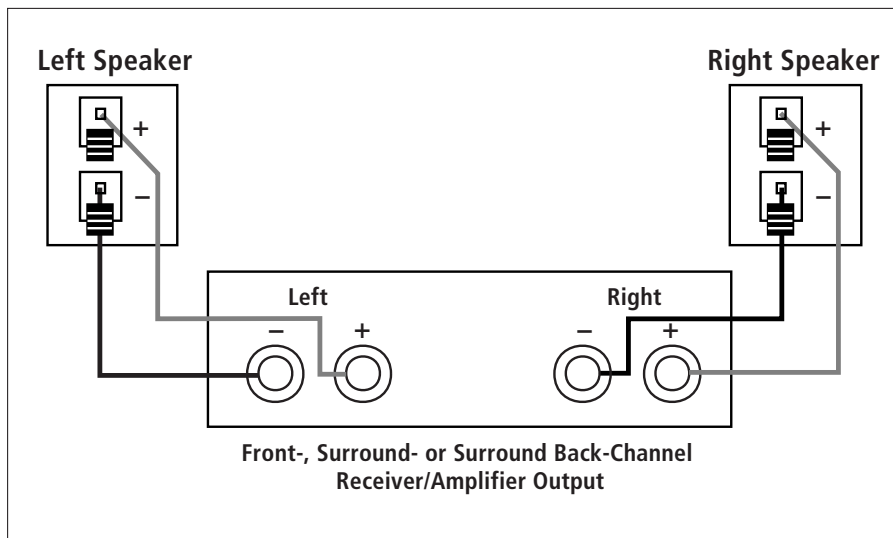

Troubleshooting

If there is no sound from any of the speakers:

- Check that receiver/amplifier is on and a source is playing.
- Check all wires and connections between receiver/amplifier and speakers. Make sure all wires are connected. Make sure none of the speaker wires are frayed, cut or punctured.
- Review proper operation of your receiver/amplifier.

If there is no sound coming from one speaker:

- Check the "Balance" control on your receiver/amplifier.
- Check all wires and connections between receiver/ amplifier and speakers. Make sure all wires are connected. Make sure none of the speaker wires are frayed, cut or punctured.
- In Dolby Digital or DTS® modes, make sure that the receiver/processor is configured so that the speaker in question is enabled.
- In Dolby Digital or DTS mode, check the speaker and channel output levels and adjust if needed.
- Turn off all electronics and switch the speaker in question with one of the other speakers that is working correctly. Turn everything back on, and determine whether the problem is in the same place: i.e., the speaker that was working previously now has no sound and the speaker that was not working now sounds fine; or whether it has moved: i.e., the speaker that was not working still has no sound and the speaker that was working is still fine. If the problem is in the same place, the source of the problem is most likely with your receiver or amplifier, and you should consult the owner's manual for that product for further information. If the problem has followed the speaker, consult your dealer for further assistance or, if that is not possible, visit our Web site at www.harmanardon.com for further information.

If the system plays at low volumes but shuts off as volume is increased:

- Check all wires and connections between receiver/ amplifier and speakers. Make sure all wires are connected. Make sure none of the speaker wires are frayed, cut or punctured.
- If more than one pair of main speakers is being used, check the minimum impedance requirements of your receiver/amplifier.

If there is low (or no) bass output:

- Make sure the connections to the left and right "Speaker Inputs" have the correct polarity (+ and -).
- Consider adding a powered subwoofer to your system.

If there is no sound from the surround speakers:

- Check all wires and connections between receiver/ amplifier and speakers. Make sure all wires are connected. Make sure none of the speaker wires are frayed, cut or punctured.
 - Review proper operation of your receiver/amplifier and its surround-sound features.
 - Make sure the movie or TV show you are watching is recorded in a surround-sound mode. If it is not, check to see if your receiver/ amplifier has other surround modes you may use.
 - In Dolby Digital or DTS® modes, make sure your receiver/processor is configured so that the surround speakers are enabled.
 - Review the operation of your DVD player and the jacket of your DVD to make sure that the DVD features the desired Dolby Digital or DTS® mode, and that you have properly selected that mode using both the DVD player's menu and the DVD disc's menu.
-

Specifications

Satellites

Recommended Power

10 – 80 Watts

Impedance

8 Ohms nominal

Frequency Response

110Hz – 20kHz (–6dB)

Sensitivity

86dB @ 1 Watt/1 meter

Tweeter

One 1/2" dome, video-shielded

Midrange

One 3" driver, video-shielded

Dimensions (H x W x D)

167mm x 100mm x 92mm

Weight

0.6kg

All features and specifications are subject to change without notice.

Harman Kardon and Power for the Digital Revolution are registered trademarks of Harman International Industries, Incorporated.

* Trademarks of Dolby Laboratories.

DTS is a registered trademark of Digital Theater Systems, Inc.

harman/kardon

H A Harman International Company
250 Crossways Park Drive, Woodbury, New York 11797
www.harmankardon.com
Harman Consumer International:
2, Route de Tours, 72500 Château-du-Loir, France
© 2004 Harman Kardon, Incorporated
Part 406-000-05024

Free Manuals Download Website

<http://myh66.com>

<http://usermanuals.us>

<http://www.somanuals.com>

<http://www.4manuals.cc>

<http://www.manual-lib.com>

<http://www.404manual.com>

<http://www.luxmanual.com>

<http://aubethermostatmanual.com>

Golf course search by state

<http://golfingnear.com>

Email search by domain

<http://emailbydomain.com>

Auto manuals search

<http://auto.somanuals.com>

TV manuals search

<http://tv.somanuals.com>