

# DVD 22 / DVD 22 B Digital Versatile Disc Player

## OWNER'S MANUAL

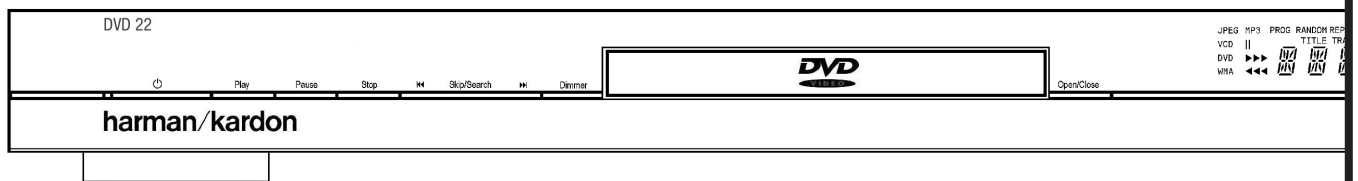

**harman/kardon®**

Power for the Digital Revolution®

# Table of Contents

- 3 Introduction
- 4 Terminology
- 5 Features, Packing List
- 6 Front Panel Controls
- 7 Front Panel Information Display
- 8 Remote Control
- 10 Rear Panel Connections
- 11 Setup and Connections
  - 11 to a Stereo TV and Stereo or Pro Logic Amplifier/Receiver
  - 12 to a Dolby Digital/DTS Amplifier/Receiver
  - 13 to a TV or monitor with SCART or Component Connectors
- 14 Remote Control
- 15 Digital Audio Connections
- 16 Playback Basics
  - 16 Basic Play
  - 16 Playback Features
- 17 System Set-up
  - 17 System Settings
  - 18 Audio Settings
  - 18 Video Settings
  - 18 Video Adjustment
- 19 Test Screen
  - 19 Test Screen
  - 19 TV Picture Adjustment
- 20 Player Menu
  - 20 Using the Status Bar
  - 20 Player Menu
  - 20 Information Displays
  - 20 Programmed Play
- 21 DVD Language Codes
- 22 Specifications

### Declaration of Conformity



We, Harman Consumer Group International  
2, Route de Tours  
72500 Château-du-Loir,  
FRANCE

declare in own responsibility, that the product described in this owner's manual is in compliance with technical standards:

EN 55013:2001  
EN 55020:2002  
EN 61000-3-2:2000  
EN 61000-3-3:1995+A1:2001  
EN 60065:2002



Jurjen Amsterdam  
Harman Consumer Group International  
07/04

**NOTE:** This player is designed and manufactured for compatibility with Region Management Information that is encoded on most DVD discs. This player is designed only for

playback of discs with Region Code 2, or for discs that do not contain Region Code information. If there is any other Region Code on a disc, that disc will not play on the DVD.



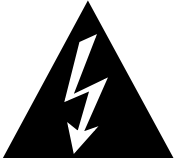



**CAUTION**

**RISK OF ELECTRIC SHOCK**

**DO NOT OPEN**



CAUTION: TO REDUCE THE RISK OF ELECTRIC SHOCK, DO NOT REMOVE COVER (OR BACK). NO USER-SERVICEABLE PARTS INSIDE. REFER SERVICING TO QUALIFIED SERVICE PERSONNEL.



The lightning flash with arrowhead symbol, within an equilateral triangle, is intended to alert the user to the presence of uninsulated 'dangerous voltage' within the product's enclosure that may be of sufficient magnitude to constitute a risk of electric shock to persons.



The exclamation point within an equilateral triangle is intended to alert the user to the presence of important operating and maintenance (servicing) instructions in the literature accompanying the appliance.

WARNING: TO REDUCE THE RISK OF FIRE OR ELECTRIC SHOCK, DO NOT EXPOSE THIS APPLIANCE TO RAIN OR MOISTURE.

## Introduction

### **Thank you for choosing the Harman Kardon DVD**

The DVD is a multipurpose DVD player, capable of playing both DVD-Video discs and conventional CD audio discs with the highest fidelity and access to future software upgrades via the Internet. Along with conventional DVD-Video and CD audio discs, the DVD is also compatible with MP3, WMA, JPEG and most recordable CD and DVD formats as well as VCD discs.

To enable you to get the maximum quality from DVDs, the DVD is equipped with the latest in design techniques, including advanced 10-bit video digital-to-analog converters (DAC) and Video (composite), S-Video and RGB video (RGB via SCART) outputs, to ensure that you get all the quality inherent in today's DVD medium. For optimum playback of NTSC and PAL DVD with compatible high-definition display devices, DVD is equipped with progressive component video outputs.

In addition, Harman Kardon's audio heritage continues into the digital video era with audiophile-grade Wolfson DACs to ensure that the audio quality matches the superb video. Of course, both coaxial and optical digital audio outputs are available for direct connection to A/V receivers or processors so that you may take advantage of Dolby Digital\* and DTS® soundtracks. When playing audio CDs, the playback quality is state-of-the-art, matching that of the finest players available.

A wide range of programming features makes it easy to program an evening's worth of entertainment. When playing DVDs, easy-to-understand on-screen menus and icons make it simple to change languages, soundtracks, subtitles or aspect ratio, while a parental-lock function enables you to control which discs may be viewed by younger members of the household.

DVD players are among the fastest growing consumer electronics products ever brought to market, but this may, nevertheless, be the first DVD player you've owned. Although many of the features of the DVD resemble those of standard CD players, there are a number of functions that you may be unfamiliar with. To ensure that you are able to take advantage of all the power and flexibility the DVD has to offer, we encourage you to review this quick setup manual. That small investment of your time will pay major dividends in the enjoyment you will get from proper use of the DVD.

- **Plays a Wide Range of Video and Audio Formats, Including DVD-Video Discs, VCD, Standard CD Audio Discs, CD-R/RW, DVD-R/RW, DVD-+R/RW, Audio Discs and MP3 Discs**
- **High-Quality Video Playback 10-Bit DACs, Progressive Scan and Component Video Outputs**
- **Dolby Digital and DTS Data Signal Output Through Both Optical and Coaxial Digital Audio Connections**
- **Audiophile-Grade Wolfson Output DACs for the Finest Audio reproduction**
- **Easy-to-Use On-Screen Navigation System**
- **Playback of MP3 and Windows® WMA Audio Discs and JPEG image files**
- **Simultaneous Playback of MP3 and JPEG files**
- **Extensive Programming Capability for Audio and Video Discs**
- **Parental Lock Controls Prevent Unauthorized Viewing of Restricted Movies**
- **Multiple Options for Language, Soundtrack and Subtitle Selection**
- **Multiple-Angle Capabilities With Specially Encoded DVD Discs**
- **Backlit, Ergonomically Designed Remote Control**

# Terminology

## Terminology

Since they share some of the characteristics and technology of CD players, many of the terms and operational concepts used in a DVD player are similar to what you may be familiar with from CD players and changers, or older video disc formats such as Laser Disc. However, if this is your first DVD product, some of the terms used to describe the features of a DVD player may be unfamiliar. The following explanations should solve some of the mysteries of DVD, and help you to enjoy all the power and flexibility of the DVD format and the DVD.

With the arrival of DVD, disc data capacity has increased dramatically. On a DVD Video disc most of this capacity is taken up by MPEG 2 video and the multichannel movie soundtrack in Dolby Digital and/or DTS. This information is compressed.

**Aspect Ratio:** This is a description of the width of a video image in relation to its height. A conventional video screen is four units wide for every three units of height, that's why the ratio is called "4:3". Newer wide aspect ratio video displays are 16 units wide for every nine units of height, making them more like the screen in a movie theater. The program material on a DVD may be recorded in either format and, in addition, you may configure the DVD to play back in either format, depending on the features recorded on a disc.

**Title:** For a DVD, a title is defined as an entire movie or program. There can be as many chapters within a title as the producers decide to include. Most discs include only one title, but some may have more than one, to give you a "Double Feature" presentation.

**Chapter:** DVD programs are divided into chapters and titles. Chapters are the sub-sections programmed into a single title on a disc. Chapters may be compared to the individual tracks on an audio CD.

**RGB Video:** This is a new form of video signal that eliminates many of the artifacts of traditional composite video signals by splitting the signal into the three fundamental colors Red, Green and Blue (RGB). With an RGB connection (via SCART), you will see greater picture resolution and eliminate many picture imperfections such as the moiré patterns often seen on checkered patterned cloths. However, in order to benefit from RGB video, you must have a video display with an RGB compatible SCART input.

**Progressive scan:** DVD offers progressive scan video outputs for use with compatible high-resolution televisions and projectors. Before DVD, no consumer medium could store, transmit or display video with full resolution. To conserve bandwidth, analog compression (interlacing) is employed: first the odd-numbered lines of a frame are displayed, followed by the even-numbered lines. The result is that only half of the video image is drawn at one time; the viewer's brain must reassemble the complete image. This is acceptable, if the monitor is not too large and if there is not too much motion in the image. Large displays and fast-moving images reveal the limitations of this system. Thanks to DVD's immense data capacity, images are now stored intact (progressively), so that all the lines in each frame (odd and even) are shown at the same time. But because most TV's cannot handle a progressive signal, all current DVD players generate an interlaced output for compatibility. Now, the Harman Kardon DVD is among the select few DVD players with true progressive scan video output (NTSC and PAL) for use with compatible TV's and CRT projectors and with all plasma, LCD and DLP display devices via the component video output. The result is 40% greater light output than a conventional TV and a stunningly detailed high definition image, along with an almost complete absence of visible scanlines and motion artifacts. Of course, traditional Y/Pr/Pb component video, SCART, S-Video and composite video outputs are included for use with conventional televisions and projectors.

**Multiple Angle:** DVDs have the capability to show up to four different views of the same scene in a program. When a disc is encoded with multiple-angle information, pressing the Angle button will enable you to switch between these different views. Note that at present, few discs take advantage of this capability and, when they do, the multiple-angle technology may only be present for short periods of time within the disc. Producers will usually insert some sort of icon or graphic in the picture to alert you to the availability of multiple viewing angles.

**Reading:** This is a message that you will see after you've loaded the disc and the tray has closed. It refers to the fact that the player must first examine the contents of the disc to see if it is a CD or DVD, and then extract the information about the type of material on the disc, such as languages, aspect ratios, subtitles, number of titles and more. The slight delay while the contents of the disc are read is normal.

**Resume:** The operation of the Stop Button on the DVD works differently from what you are used to on CD players. On a traditional CD player, when you press the Stop button, the unit does just that: it stops playback. On a CD player, when you press the start button again, the disc starts from the beginning. With the DVD, however, you have two options when playing DVD discs. Pressing Stop once will stop playback, but it actually puts the unit in the Resume mode. This means that you can turn the machine off and, when you press play the next time, the disc will resume or continue from the point on the disc where the Stop button was pressed. This is helpful if you are watching a movie and must interrupt your viewing session but wish to pick up where you left off. Pressing the Stop button twice will stop the machine in a traditional manner and, when the disc is played again, it will start from the beginning.

In resume mode, the cover of the DVD will be displayed, if available. Otherwise, the Harman Kardon screen will appear.

## Features

### High quality video

- Advanced sophisticated 10-bit MPEG-2 video decoding circuits.
- Direct RGB output via SCART (selectable) for optimum video performance. SCART connector also configurable for Composite Video output.
- Test screen videos available for testing video performance and setup.
- Pure PAL with NTSC disc due to true NTSC/PAL conversion.
- Dual-layer compatibility for extended play DVD.
- Progressive Scan component video outputs (NTSC and PAL)
- Playback of JPEG image files

### High quality digital audio

- By connecting a DTS (Digital Theater Systems) or a Dolby Digital decoder, you can enjoy high quality 5.1 digital surround sound from DTS or Dolby Digital discs.
- With linear PCM audio at 16-24 bits and 44-96 kHz (also on digital output, see table page 15), audio quality exceeding that of CD becomes possible.
- Optical and coaxial digital audio output.

### Many convenient features

- On-Screen Menu Icons for disc information or player information and access to many major functions of this unit.
- Subtitles may be displayed in one of numerous languages\*.
- The multi-angle function allows you to choose the viewing angle of scenes which were shot from a number of different angles (Limited to DVD's recorded with multiple camera angles.)
- Multiple options for dialog language and soundtrack selection (limited to DVD's recorded with multiple dialog languages or soundtracks).
- Parental lock settings to prevent play of discs unsuitable for some audiences [DVD only].
- Intuitive menu operating system.
- 4 step Zoom during play and pause.
- Backlit, ergonomically designed remote control.
- Future software upgrades accessible via Internet. (See information below.)

\* The number of languages recorded depends on the software.

### Compatible with CD as well as DVD

- The DVD will play any conventional Audio CD or recordable (CD-R) or erasable CD (CD-RW) bearing the logos shown here, MP3, WMA (v8) or any VCD or DVD-Video with the region code 0 or 2.

### Disc formats supported by this player

The unit can play the following disc formats (8 cm and 12 cm size):

- DVD-Video
- DVD-R
- DVD-RW
- DVD+R
- DVD+RW
- CD
- CD-R
- CD-RW
- VCD
- S-VCD

**NOTE:** Due to differences in the format of certain discs, it is possible that some discs may include a mix of features that are not compatible with the DVD. Similarly, although the DVD is capable of a wide range of features, not all discs include every capability of the DVD system. For example, although the DVD is compatible with multi-angle discs, that feature is only possible when the disc is specially encoded for multiple-angle play. In addition, the DVD is capable of playing back both Dolby Digital and DTS soundtracks, but the number and types of tracks available will vary from disc to disc. To make certain that a specific feature or soundtrack option is available, please check the options noted on the disc jacket.

■ Playback capability for CD-R, CD-RW, WMA, JPEG, MP3, VCD/SVCD, DVD-R, DVD+R, DVD-RW and DVD+RW discs may vary due to variations in the quality of the disc and the recorder used to create the disc.

### Upgradeability via Internet

The "firmware" controlling the functionality of the Harman Kardon DVD is fully upgradeable. In the event of future improvements to its operations and features, it will be possible to download firmware upgrades from [www.harmankardon.com/International/](http://www.harmankardon.com/International/) All you have to do is create a CD-R with the data and insert it in the DVD for an automatic upgrade.

### Packing List

- 1 Harman Kardon DVD Player
- 1 Remote control
- 2 AA batteries
- 1 A/V cable for stereo analog audio and composite video
- 1 S-Video cable
- 1 remote extension cable
- 1 owner's manual

## Front Panel Controls

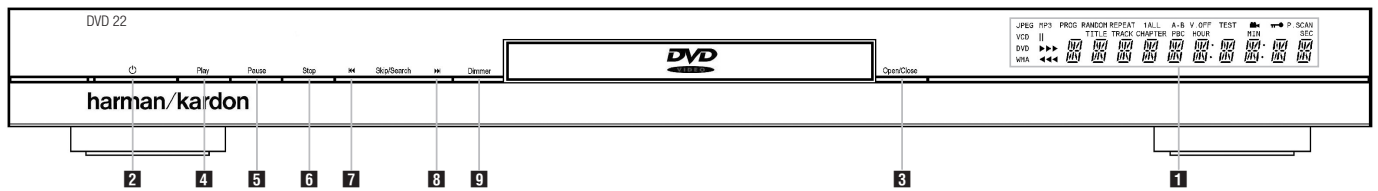

- |                                   |                |                                 |
|-----------------------------------|----------------|---------------------------------|
| <b>1</b> Main Information Display | <b>4</b> Play  | <b>7</b> Skip/Search (Previous) |
| <b>2</b> Power On/Off (Standby)   | <b>5</b> Pause | <b>8</b> Skip/Search (Next)     |
| <b>3</b> Eject                    | <b>6</b> Stop  | <b>9</b> Dimmer                 |

**1 Main Information Display:** This display delivers messages and status indications to help you operate the DVD player.

**2 Power On/Off (Standby):** Press the button once to turn the DVD player on, press it again to put the unit in the Standby mode.

**3 Eject:** Press this button to open or close the Disc Tray.

**4 Play:** Press to initiate playback or to resume playback after Pause has been pressed.

**5 Pause:** Press this button to momentarily pause playback. To resume playback, press the button again. If a DVD is playing, action will freeze and a still picture will be displayed when the button is pressed.

**6 Stop:** Press this button once to place the disc in the Resume mode, which means that playback will stop, but as long as the tray is not opened or the disc changed, DVD playback will continue from the same point on the disc when the Play Button is pressed again. Resume will also work if the unit was turned off. To stop a disc and have play start from the beginning, press the button twice.

**7 Skip/Search (Previous):** Press this button to move backward through the music tracks on a CD disc or the chapters on a DVD disc. Keep the button pressed to search backwards at one of the available speeds.

**8 Skip/Search (Next):** Press to move forward through the music tracks on a CD or the chapters on a DVD disc. Keep the button pressed to search forwards at one of the available speeds.

**9 Dimmer:** Press this button to reduce the brightness of the Information Display by 50% or to turn the display off completely in the following order: FULL BRIGHTNESS → HALF BRIGHTNESS → OFF → FULL BRIGHTNESS.

## Front Panel Information Display

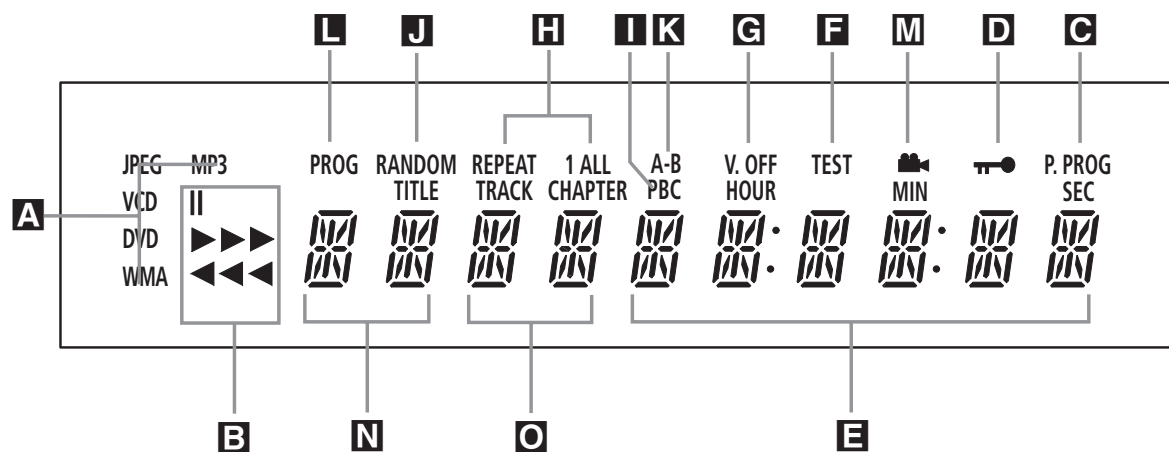

**A** Disc Type Indicators

**B** Playback-Mode Indicators

**C** Progressive Scan Indicator

**D** Parental Lock Indicator

**E** Time Indicators

**F** Test Indicator

**G** V-OFF Indicator

**H** Repeat Indicators

**I** VCD Playback Control Indicator

**J** Random Indicator

**K** A-B Repeat Indicator

**L** Program Indicator

**M** Angle Indicator

**N** Title Indicators

**O** Chapter/Track Number Indicators

**A Disc Type Indicators:** The DVD, CD, VCD, MP3, WMA or JPEG indicator will illuminate to show the type of disc currently being played.

**B Playback-Mode Indicators:** These indicators light to show the current playback mode:

▶ Lights when a disc is playing in the normal mode

▶▶ Lights when the disc is in the Fast Search Forward mode. The on-screen banner display indicates the selected speed (2x, 8x, 16x, 100x).

|| Lights when the disc is paused.

◀◀ Lights when the disc is in the Fast Search Reverse mode. The on-screen banner display indicates the selected speed (2x, 8x, 16x, 100x).

**C Progressive Scan Indicator:** This indicator lights when the unit sends out a progressive scan signal.

**D Parental Lock Indicator:** This indicator lights when the parental-lock system is engaged in order to prevent anyone from changing the rating level without a code.

**E Time Indicators:** These positions in the indicator will show the running time of a DVD in play. When a CD is playing, these indicators will show the current track time, time remaining in the current track, or the total remaining time on the disc.

**NOTE:** The Indicators **NOE** will also display text messages about the DVD's status, including **Reading** when a disc is loading, **STANDBY** when the unit is turned off, and **Disc Error** when a disc not compatible with the DVD is put into the play position.

**F Test Indicator:** This indicator lights when the TV test screen is activated.

**G V-OFF Indicator:** This indicator lights when the unit's video output has been turned off by pressing the V-OFF button on the remote control.

**H Repeat Indicators:** These indicators light when any of the Repeat functions are in use.

**I VCD Playback Control Indicator:** This indicator lights when the playback control function is turned on with VCDs.

**J Random Indicator:** This indicator lights when the unit is in the Random Play mode.

**K A-B Repeat Indicator:** This indicator lights when a specific passage for repeat playback has been selected.

**L Program Indicator:** This indicator lights when the programming functions are in use.

**M Angle Indicator:** This indicator blinks when alternative viewing angles are available on the DVD currently playing.

**N Title Indicators:** These two positions in the display will show the current title number when a DVD disc is playing.

**O Chapter/Track Number Indicators:** When a DVD disc is playing, these two positions in the display will show the current chapter. When a CD disc is playing they will show the current track number.

## Remote Control Functions

- ➊ POWER ON
- ➋ POWER OFF
- ➌ SUBTITLE
- ➍ TITLE
- ➎ ANGLE
- ➏ AUDIO
- ➐ ENTER
- ➑ OPEN/CLOSE
- ➒ OSD
- ➓ ARROWS
- ➔ INFO
- ➕ MENU
- ⏸ PAUSE
- ➡ STATUS
- ⏮ SKIP/STEP (PREVIOUS)
- ⏭ SKIP/STEP (NEXT)
- ▶ PLAY
- ⏪ SEARCH/SLOW REVERSE
- ⏹ STOP
- ⏩ SEARCH/SLOW FORWARD
- 📺 DISPLAY
- ⏪ PIC +/PIC -
- 🔍 ZOOM
- 📄 PLAYLIST
- 🎲 RANDOM
- ⏮ A-B Repeat
- 📺 V.OFF
- 💡 LIGHT
- ➊ NUMERIC KEYS
- 🔄 REPEAT
- 🗑 CLEAR

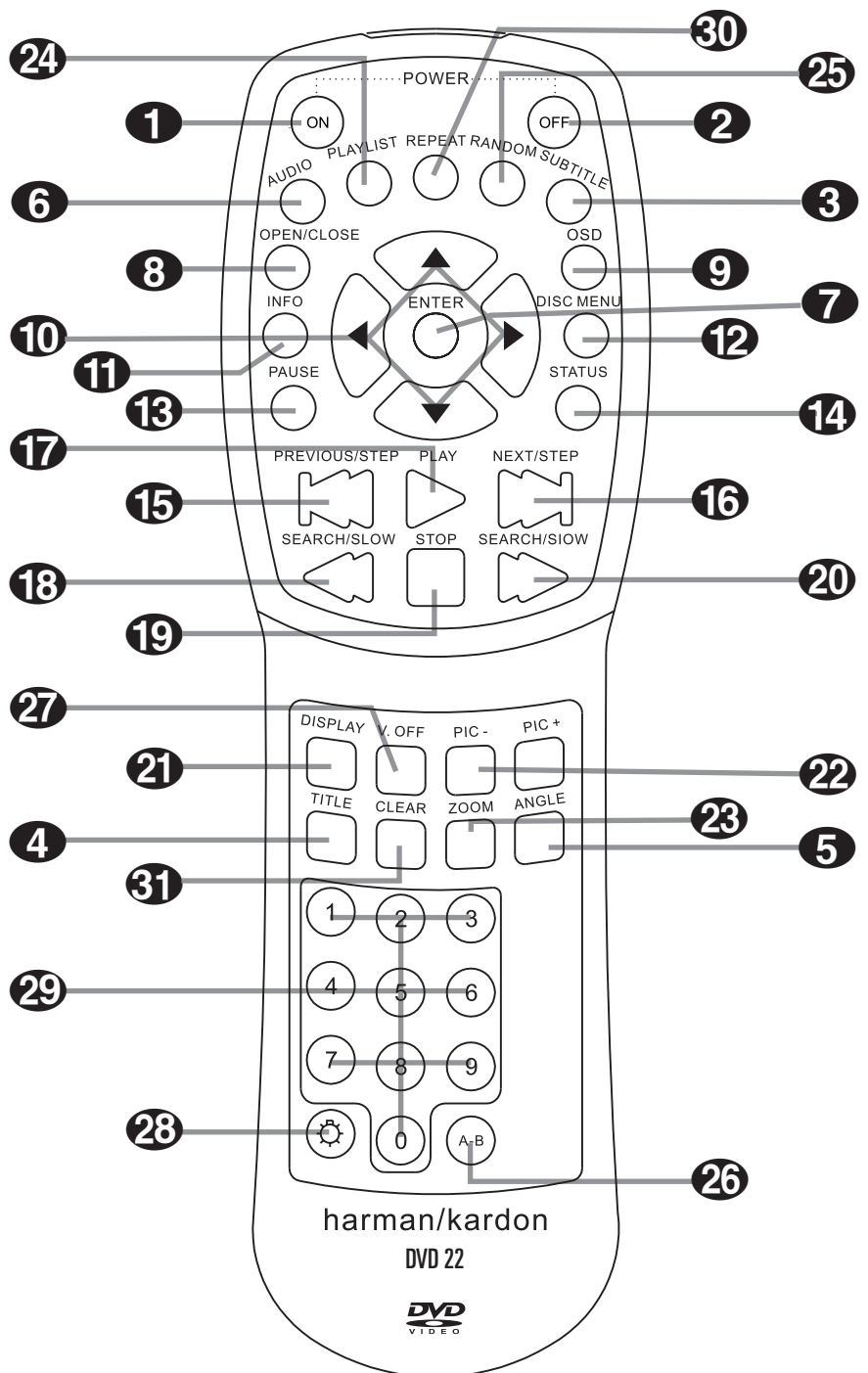



## Remote Control Functions

- 1 POWER ON:** Turns on the player when it is in standby mode (Harman Kardon logo appears on screen).
- 2 POWER OFF:** Turns off the player to standby mode.
- 3 SUBTITLE:** When a DVD is playing, press to select a subtitle language or to turn subtitles off.
- 4 TITLE:** When a disc is playing, press to show the number of the title currently played. Press TITLE again to jump to the subsequent title (with the next title number) on the disc. Note that this function works (most times) even if title jump is prohibited by a DVD's playback control.
- 5 ANGLE:** Press to access various camera angles on a DVD (If the DVD contains multiple camera angles).
- 6 AUDIO:** Press to access various audio languages on a DVD (If the DVD contains multiple audio streams).
- 7 ENTER:** Press this button to activate a setting or option
- 8 OPEN/CLOSE:** Press to open or close the disc tray.
- 9 OSD:** Press to access the On Screen Display Menu
- 10 ARROW buttons (◀/▶/▲/▼):** Use to move the cursor in the OSD.
- 11 INFO:** Press once for detailed informations on the disc playing (Video/Audio Bit rate, Movie aspect ratio and others), press again for current player settings made. Note that the unit doesn't react on any transport button as long as the info menu is displayed. Press again to remove information from screen.
- 12 MENU:** Displays the actual DVD Disc Menu on the TV screen in play mode.
- 13 PAUSE:** Freezes a picture (with DVD/VCD) and pauses the playback signal (CD) when a disc is playing. Press again for normal playback.
- 14 STATUS:** Press while a disc is playing to view banner display. Use the ARROW buttons to move through the different features in the Banner Display. When a symbol is highlighted, press ENTER on the remote to select it.
- 15 SKIP/STEP (Previous):** Press to go to beginning of current track. Press again quickly to go to beginning of previous track. After pressing the PAUSE button, each press of this button will move the image in reverse frame by frame.
- 16 SKIP/STEP (Next):** Press to go to beginning of next track. After pressing the PAUSE button, each press of this button will move the image forwards frame by frame.
- 17 PLAY:** Begins to play disc (closes disc tray first, if it is open.)
- 18 SEARCH/SLOW (REV):** Allows you to search in reverse through a disc while it is in play mode. Each time you press this button, the search speed changes as indicated by a number of arrows on the right top of your screen. After pressing the PAUSE button, each press of this button will change the slow down speed indicated by a number of arrows in the right top of the screen.
- 19 STOP:** Stops playing a disc. When a disc is playing, if you press STOP and PLAY, the disc will resume play, i.e. it will start from the same point on the disc where the unit was stopped. If you press STOP twice and the PLAY button, the disc will start play from the beginning.
- 20 SEARCH/SLOW (FWD):** Allows you to search forward through a disc while it is in play mode. Each time you press this button, the search speed changes as indicated by a number of arrows on the right top of your screen. After pressing the PAUSE button, each press of this button will change the slow down speed as indicated by a number of arrows in the right top of the screen.
- 21 DISPLAY:** Press to change the brightness of the front panel display or to turn the display off completely in the following order: FULL BRIGHTNESS → HALF BRIGHTNESS → OFF → FULL BRIGHTNESS
- 22 PIC+/PIC-:** Pressing these buttons in JPEG mode will move to the previous or next image.
- 23 ZOOM:** When a DVD or VCD is playing, press this button to zoom the picture so that it is enlarged. There are 4 steps to the zoom function, each progressively larger. Press through each of the zoom stages to return to a normal picture.
- 24 PLAYLIST:** Press this button to change the playback order of the disc.
- 25 RANDOM:** Press for RANDOM playback in random order.
- 26 A-B:** Press to select section A-B and to play repeatedly.
- 27 V.OFF:** Press to turn off video output for improved performance from audio-only discs. Press again to restore video output.
- 28 LIGHT:** Press to illuminate remote controller.
- 29 NUMERIC KEYS:** Select numbers by pressing these buttons.
- 30 REPEAT:** Press to go to the Repeat menu. You can repeat a chapter, track or the entire disc.
- 31 CLEAR:** Press to remove the Banner menu from the screen.

## Rear Panel Connections

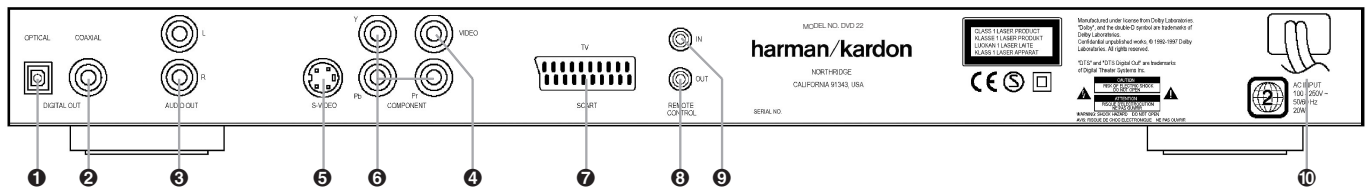

- 1 Optical Digital Output
- 2 Coaxial Digital Output
- 3 Analog Audio Outputs
- 4 Composite Video Output
- 5 S-Video Output
- 6 Component Video Outputs
- 7 SCART TV Output
- 8 Remote Control Output
- 9 Remote Control Input
- 10 AC Power Cord

**1 Optical Digital Output:** Connect this jack to the optical digital input of an A/V receiver or surround processor for Dolby Digital, DTS or PCM audio playback.

**2 Coaxial Digital Output:** Connect this jack to the coaxial digital input of an A/V receiver or surround processor for Dolby Digital, DTS or PCM audio playback.

**NOTE:** The coaxial digital output should only be connected to a digital input. Even though it is the same RCA-type connector as standard analog audio connections, DO NOT connect it to a conventional analog input jack.

**3 Analog Audio Outputs:** Connect these jacks to the analog audio input on an A/V receiver or surround processor for analog audio playback.

**4 Composite Video Output:** Connect this jack to the video input on a television or video projector, or to a video input on an A/V receiver or processor if you are using that type of device for video input switching.

**5 S-Video Output:** Connect this jack to the S-Video input on a television or video projector, or to an S-Video input on an A/V receiver or processor if you are using that type of device for S-Video input switching.

**6 Component Video Outputs:** These outputs carry the component video signals for connection to display monitors with component video inputs. For standard analog TV's or projectors with inputs marked Y/Pr/Pb or Y/Cr/Cb, connect these outputs to the corresponding inputs. If you have a high-definition television or projector that is compatible with high scan rate progressive video, connect these jacks to the "HD Component" inputs. Note that if you are using a progressive scan display device, then "Progressive" must be selected in the Video Setup Menu in order to take advantage of the progressive scan circuitry. See page 17 for more information on progressive scan video.

**IMPORTANT:** These jacks should NOT be connected to standard composite video inputs.

**7 SCART OUT (TV):** If your TV has a SCART socket, you can connect a SCART cable to your TV and to your DVD Player for improved video quality. The SCART cable carries both audio and video. You can select Composite Video or RGB video for that SCART connector's video output signal.

**8 Remote Control Output:** Connect this jack to the infrared (IR) input jack of another compatible Harman Kardon remote controlled product to have the built-in Remote Sensor on the DVD provide IR signals to other compatible products.

**9 Remote Control Input:** Connect the output of a remote infrared sensor, or the remote control output of another compatible Harman Kardon product, to this jack. This will enable the remote control to operate even when the front panel **Remote Sensor** on the DVD is blocked. This jack may also be used with compatible IR remote control-based automation systems.

**10 AC Power Cord:** Connect this plug to an AC outlet. If the outlet is controlled by a switch, make certain that it is in the ON position.

**Note:** You'll find more details about all Audio/Video connections under Setup and Connections on the following pages.

## Setup and Connections

- Ensure that the power switch of this unit and other equipment to be connected is set to off before commencing connection.
- Do not block ventilation holes of any of the equipment and arrange them so that air can circulate freely.
- Read through the instructions before connecting other equipment.
- Ensure that you observe the color coding when connecting audio and video cables.

### Connecting to a stereo TV and stereo or Pro Logic Amplifier/Receiver

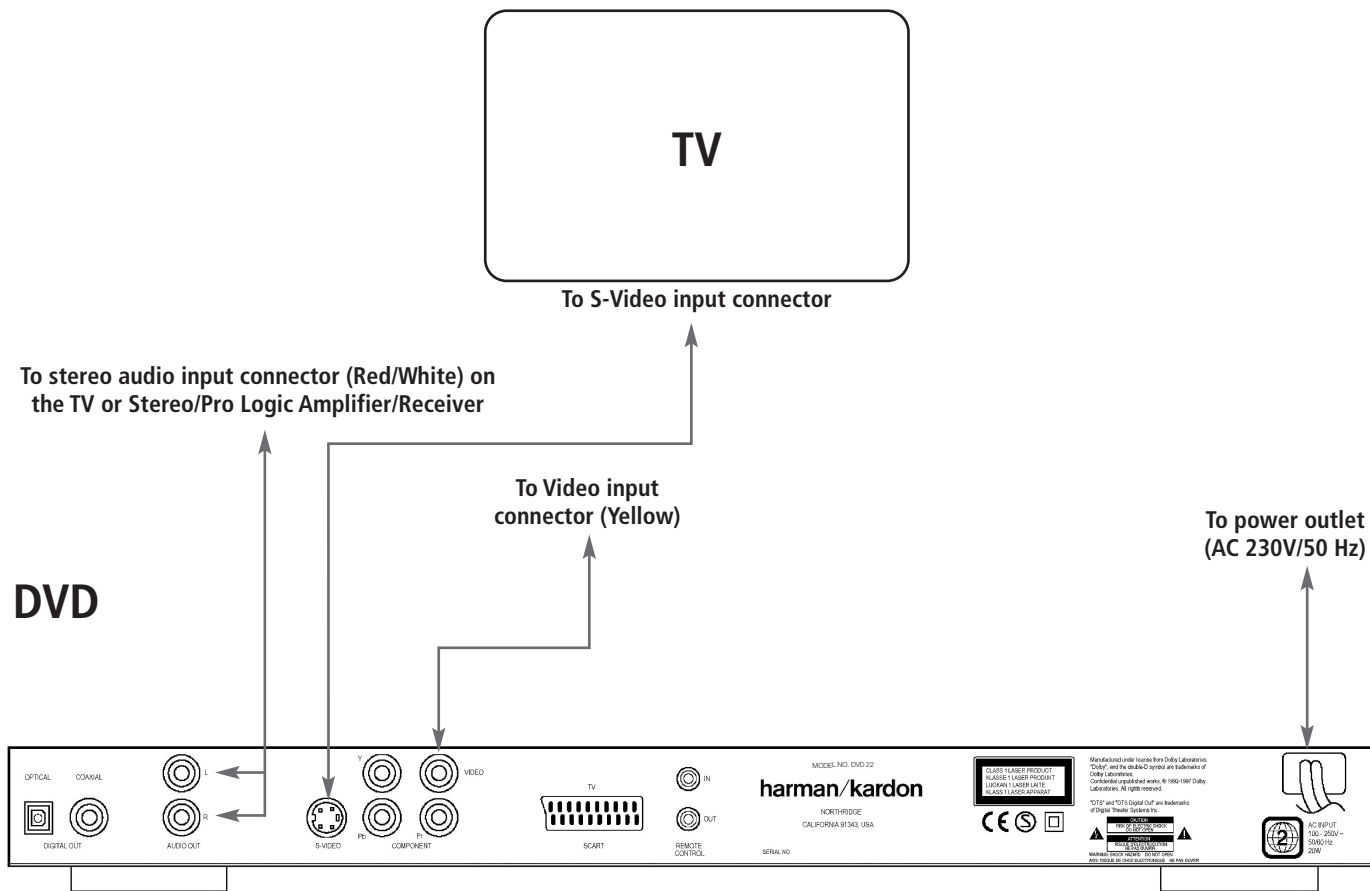

#### Notes:

- The Video output (yellow) combines the complete video signal (composite) and sends it to the TV (or to the AV Receiver) by one line only. Use the Video output, when your TV set is equipped with a Video input jack only.
- The S (separate) video output connector separates the color (C) and luminance (Y) signals before transmitting them to the TV set in order to achieve a sharper picture. Use the S-video cable when connecting the player to a TV equipped with an S-video input for improved picture clarity. Never connect both outputs, Video and S-Video, to your TV or AV Receiver, only one of them.
- Most European TV's are equipped with SCART connectors rather than with a normal video input (yellow cinch). In that case the SCART connection should be used, providing the audio signal too. Separate analog audio connections to TV are needed only if your TV is connected to the video or S-video output.
- When the audio signal is to be fed to a stereo or Pro Logic amplifier/decoder or receiver rather than to the TV, connect the Audio Out jacks to any normal audio input on your amplifier/decoder/receiver. The DVD will "downmix" Dolby Digital recordings to Pro Logic, available on these connectors, all analog surround or stereo signals will be fed to them directly. You can also select the audio and video signals of all your video devices with your AV Receiver/Amplifier. For more information see "Note" on next page.

## Setup and Connections

### Connecting to a receiver/amplifier with Dolby Digital (AC-3) or DTS (Digital Theater Systems) decoder

When DVD's encoded in Dolby Digital or DTS are played, the Dolby Digital or DTS bitstream is output from the player's OPTICAL or COAXIAL digital audio output. When the player is connected to a Dolby Digital or DTS decoder, you can enjoy theater-quality audio in your home. An optical digital audio cable or coaxial audio cable (both optional) is required for these connections, as shown below. Only one connection is needed, not both at the same time.

■ **Note:** With multiple video sources, your Audio/Video device can be used for selecting the video signal and routing it to the TV. Connect the video or S-video output of the DVD player (whatever is provided with your device) to the video or S-video input on your device and the video/S-video output of this device to your TV. For more details, see the manual of your Audio/Video amplifier/receiver.

■ **Note for Analog Audio:** The connection from Audio Out to the TV is optional only. Normally you'll hear the sound from your AV-system's speakers, so the TV volume should be completely turned down. If you plan to use your DVD player also without having to turn on your complete system, this connection must exist, then you can turn up the TV's volume as needed.

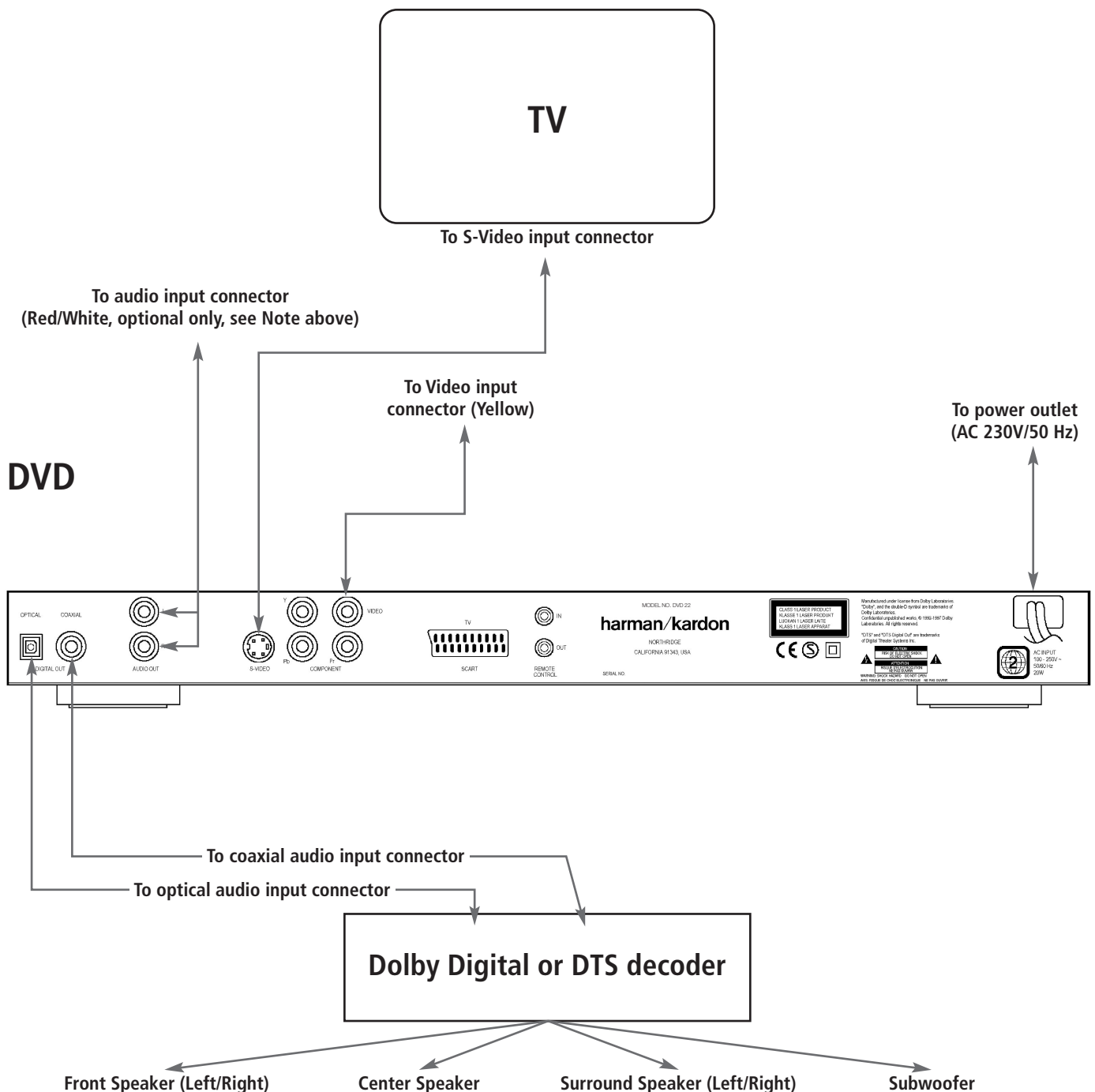

# Setup and Connections

## Connecting to a TV or monitor with SCART or Component connectors

### Important Notes on SCART and RGB format:

- Your DVD is equipped with a SCART connector for direct connection to the TV.
- The SCART connector provides the video signal as well as audio (stereo L/R) signals.
- The SCART connector for the TV provides the composite video signal or the direct RGB signal, delivering the best video performance possible, selectable in the Setup menu. To view RGB video on your TV, the RGB compatible SCART connector on the TV must be used and the DVD's TV SCART connector must be set to "RGB".

Note that with RGB video the color intensity cannot be adjusted with most TVs.

- When the RGB video signal is used, DVD's recorded with the NTSC format (with regional code 0 or 2) can be viewed even on non-NTSC compatible TVs.

### Component Video Connection

If the video display has component video inputs, connect the Component Video Outputs on the DVD to the corresponding input jacks on your television. If you are using a progressive scan television or projector, you must also change the Scan Type in the DVD player's Video Set-Up Menu from "Interlaced" to "Progressive".

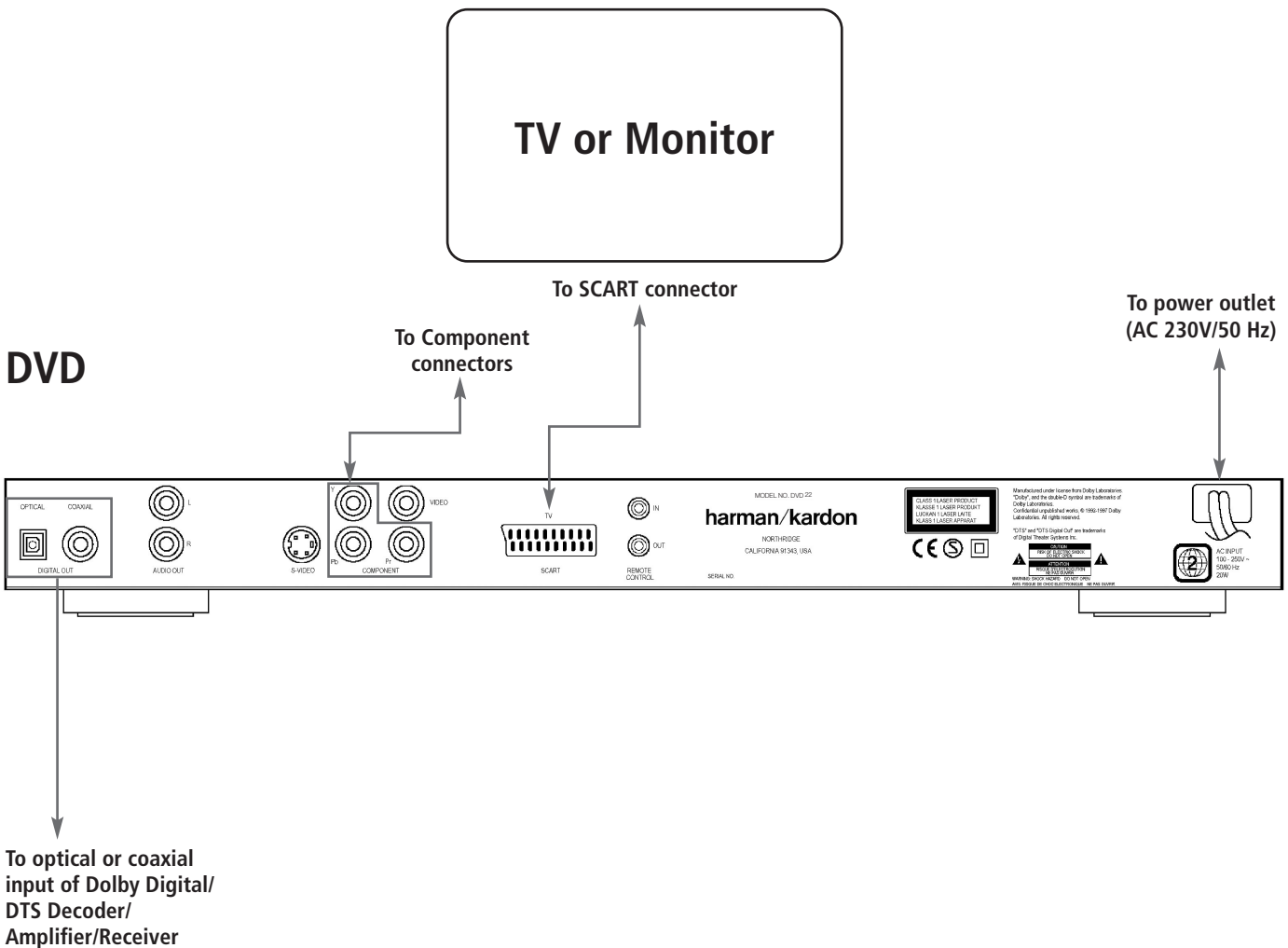

## Remote Control

### Battery installation

Insert the batteries supplied while observing the correct (+) and (-) polarities.

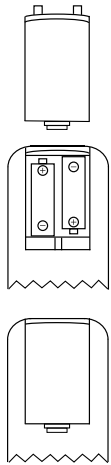

### Service life of batteries

- The batteries normally last for about one year, although this depends on how often, and for what operations, the remote control is used.
- If the remote control unit fails to work even when it is operated near the player, replace the batteries.
- Use size "AA" batteries.

#### Notes:

- Do not attempt to recharge, short-circuit, disassemble, heat or throw the batteries into fire.
- Do not drop, step on or otherwise impact the remote control unit. This may damage the parts or lead to malfunction.
- Do not mix old and new batteries.
- Wipe away any leakage inside the remote control unit, and install new batteries.
- If leakage should come into contact with parts of your body, wash it off thoroughly with water.
- Batteries contain chemical substances and we recommend that you dispose of them properly and in compliance with any local regulations. Do not simply throw them away but return to your dealer or special battery disposal centers.

### Remote control operation range

Point the remote control unit from no more than about 7 m from the remote control sensor and within about 60 degrees of the front of the unit.

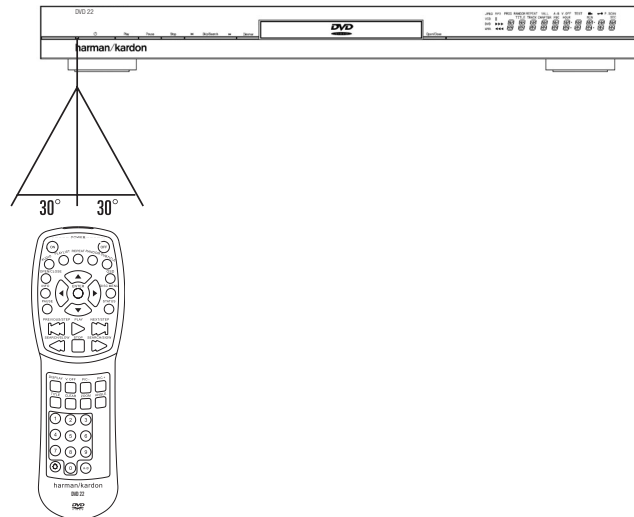

- The operating distance may vary according to the brightness of the room.

#### Notes:

- Do not point bright lights at the remote control sensor.
- Do not place objects between the remote control unit and the remote control sensor.
- Do not use this remote control unit while simultaneously operating the remote control unit of any other equipment.

## Digital Audio Connections

### Audio output from the unit's optical/coaxial digital audio output connector

Disc:	Sound recording format:	Optical/Coaxial digital audio output
DVD	Dolby Digital (AC-3)	Dolby Digital bitstream (2-5.1 ch) or PCM (2 ch, 48 kHz/16bit) *
	Linear PCM (48/96 kHz 16/20/24bit)	Linear PCM (2 ch) (48/96 kHz 16/20/24bit)
	DTS	DTS Bitstream or no output *
	MPEG (2.0)	MPEG bitstream (2ch) or linear PCM (2 ch, 48kHz)
VCD	MPEG-1 or CD-DA	Linear PCM*
CD	Linear PCM	Linear PCM (44.1 kHz sampling)

\* Digital Format must be selected as "ORIGINAL" or "PCM" respectively in Menu

### For your reference:

- Dolby Digital (AC-3) is a digital sound compression technique developed by the Dolby Laboratories Licensing Corporation, supporting 5.1-channel surround sound, as well as stereo (2-channel) sound, this technique enables a large quantity of sound data to be efficiently recorded on a disc.
- Linear PCM is a signal recording format used in CDs. While CDs are recorded in 44.1 kHz/16 bit, DVDs are recorded in 48 kHz/16 bit up to 96 kHz /24 bit.
- If you have a Dolby Pro Logic Surround decoder connected to the DVD's analog AUDIO OUT connectors, thanks to the "Downmix" function of the DVD you will obtain the full benefit of Pro Logic from the same DVD movies that provide full 5.1-channel Dolby Digital soundtracks, as well as from titles encoded with Dolby Surround.
- The DVD is designed to digitally output 96 kHz-PCM audio with a 96 kHz sampling rate. However, some 96 kHz DVD's may include copy protection codes that do not permit digital output. For full 96 kHz fidelity from these discs, use the analog outputs of the DVD.

**IMPORTANT:** If your surround processor/D/A converter does not support 96 kHz PCM audio, you must use the DVD analog outputs for full 96 kHz fidelity with these discs.

### Caution for the optical/coaxial digital audio outputs:

- When connecting an amplifier (with an optical/coaxial digital input ) which does not contain a Dolby Digital (AC-3) or DTS decoder, be sure to select "PCM" as initial setting in the "Digital Output" menu (see also page 18).  
Otherwise, any attempt to play a DVD may cause such a high level of noise that it may be harmful to your ears and damage your speakers.
- CD's can be played as they would normally be played.

#### Note:

- Some first generation DTS decoders which do not support DVD-DTS interface may not work properly with the DVD/CD player.

### Notes when connecting the optical digital audio cable (optional)

- Remove the dust protection cap from the optical digital audio output and connect the cable firmly so that the configurations of both the cable and the connector match.
- Keep the dust protection cap and always reattach the cap when not using the connector.

### Dolby Digital and DTS

Both Dolby Digital and DTS are audio formats used to record 5.1-channel audio signals onto the digital track of film. Both of these formats provide six separate channels: left, right, center, left rear, right rear, and common subwoofer. The latest 6.1-formats, Dolby Digital EX and DTS ES, even one (or two) additional "Surround Back" channel for a center between the rears.

Remember, that Dolby Digital or DTS will only play 5.1-channel sound if you've connected the optical or coaxial output of the DVD player to a DTS or Dolby Digital receiver or decoder and if the disc was recorded in the Dolby Digital or DTS format.

Dolby Digital is a trademark of Dolby Laboratories Licensing Corporation.  
Manufactured under license from Dolby Laboratories. "Dolby" and the double-D symbol are trademarks of Dolby Laboratories.  
Confidential Unpublished Works. 1992-1997  
Dolby Laboratories, Inc. All rights reserved.  
DTS is a registered trademark of Digital Theater Systems.

# Playback Basics

## Basic Play

### Preparation

1. Switch the TV ON and select its video input connected to the DVD.
2. Press POWER to turn on the unit, the DVD harman/kardon logo should appear now on the screen. If that logo appears distorted on the screen or without any color, change the appropriate settings at the Video Setting Submenu according to your TV set and to the connection used between the DVD and your TV.
3. When you see no video at all, not even the harman/kardon logo, check the setting of the video input used on your TV (most SCART inputs on TVs can be configured in the TV's menu). When you don't succeed, connect your TV with different cables to the DVD, e.g. via Composite (yellow jacks) or S-Video cables, rather than per SCART to view the setup menus until all appropriate "Video menu" settings are made properly.
4. Switch on your A/V system's power, if the player has been connected to such a system.
5. Press OPEN/CLOSE to open the disc tray.
6. Place a disc on the disc tray.  
Hold the disc without touching either of its surfaces, position it with the side you wish to play facing down, align it with the guides, and place it in its proper position.
  - 3" (8 cm) discs or 5" (12 cm) discs can be used.
7. Press PLAY. The disc tray is automatically closed and play begins.
  - When the disc tray is closed by pressing OPEN/CLOSE, play will start automatically.
  - With most DVD's, a Disc Menu appears on the screen. Select specific menu item by using ARROW buttons on the remote, then press ENTER.

## Disc Playback Features

### Skipping tracks or titles/chapters

To move forward or backward through the tracks on a CD or the titles or chapters on a DVD, press SKIP on the front panel or PREVIOUS/NEXT on the remote.

### Fast Motion Playback/Fast Search

1. To move forward or backward through the DVD or CD disc being played at fast speed, press SEARCH on the remote. Once one of these buttons is pressed, the fast search will continue until PLAY is pressed.

There are four fast-play speeds. Each press of the SEARCH Buttons will cycle to the next speed in the following order: 2x, 4x, 16x, 100x, indicated by a number of arrow indicators on the right top of the screen.

2. Press PLAY at any time to resume normal playback.

Note that there will be no audio playback during fast-forward or -reverse play of DVD discs. This is normal for DVD, as A/V receivers and surround processors cannot process the digital audio streams during fast-play modes; audio will be heard during fast-play of conventional CD's.

### Freeze Frame and Frame Advance (with DVD only)

1. Press PAUSE when a DVD is playing to freeze the picture.
2. Each time you press one of the STEP (FWD or REV) buttons, the picture advances one frame in the selected direction.
3. Press PLAY to resume normal playback.

### Slow Motion Playback (with DVD only)

1. When a DVD disc is in pause or freeze frame mode, you may move slowly forward or backward through the program being played at one of four speeds by pressing the Play Buttons on the remote. Each press of the buttons will move to the next speed, indicated by a number of arrow indicators on the right top of the screen.
2. Press PLAY to resume normal playback.

Note that there will be no audio playback during slow-forward or -reverse play of DVD discs. This is normal for DVD, as A/V receivers and surround processors cannot process the digital audio streams during slow modes. Slow play is not available for CD.

**Notes:** Playback features may not be available during the opening credits of a movie. This is intended by the disc author and is not a failure of the DVD.

Playback of a DVD with 96 kHz/24-bit audio requires the use of circuitry normally used for other features. Accordingly, Slow Play Reverse and Step Advance features are not available with these discs.

Depending on the structure of a VCD disc, the functions Slow Reverse and Step Reverse may be prohibited or have no function and Fast Playback (Search) may not function.



# System Setup

## System Defaults

The final step of the installation is to establish the system's defaults. It is helpful to take a few minutes to familiarize yourself with these settings, as they may require change before the first use and later from time to time.

### General Functionality of the OSD Menu

The complete setup and control of the DVD 22 takes place in an advanced user-guided On Screen Display (OSD) menu system. The OSD can be activated by pressing the OSD button on the remote control. Pressing this button again deactivates the OSD.

The main menu consists of a PLAYER Menu and a SET-UP Menu. The PLAYER Menu will show all information and options available for the disc currently playing. The SET-UP Menu will help you configure all audio and video settings which are normally only made once.

Each Main Menu contains Submenus. These submenus are shown as icons on the left side of the menu. They can be highlighted by a white square around the icon by moving the cursor with the ARROW buttons. Icons can be activated by pressing ENTER as soon as an icon is highlighted. When ENTER has been pressed, the color of the icon will change to dark blue and you will see that the Actual Settings of this submenu will appear on the right side of the menu.

Although each Menu has various Submenus and Settings, navigating through menus, submenus and settings goes the same way. All submenus, settings and options can be accessed with the help of the ARROW (▲▼▶◀) and ENTER buttons on the remote control.

To change a setting, simply move the cursor to the setting you wish to change. This setting will be highlighted in light blue, and a brief explanation will appear in the Upper Menu Line on the bottom of your screen. Once the setting is highlighted, pressing the ENTER button on the remote control will show the available options for this setting on the Lower Menu Line on the bottom of your screen. Move the ARROW ◀ / ▶ buttons to the requested option for this setting. Press ENTER to activate the new setting.

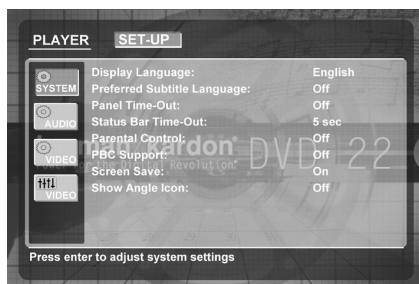

## Set Up Menu

The first step in checking or changing the system defaults is to access the Setup Menu. First, make certain that the DVD is properly connected to a video display, and that power is connected. For this process, however, you do not need to load any discs into the unit.

During STOP, PAUSE or PLAY mode, if you press OSD on the remote, the Set Up Menu appears on the screen.

This Main Menu and all menus in the following section may look different, listing the settings with different languages, depending on the settings made previously. With the factory default setting all languages are set to "English", that's why with all menus the English version is shown in the manual.

In the SET-UP Menu you will find submenus for making or changing all settings and adjustments for both Audio and Video handling of your DVD 22.

To access the SET-UP Menu, press the OSD button, and move the cursor to the right until SET-UP is highlighted. Press ENTER to activate the SYSTEM Settings:

## System Settings

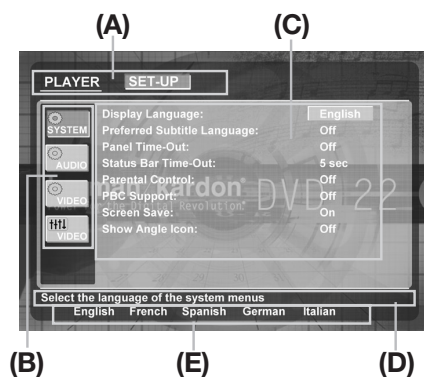

- (A) Main Menu Line
- (B) Submenus
- (C) Actual Settings
- (D) Upper Menu Line with Brief Explanation
- (E) Lower Menu Line with Possible Options

The System Setting Submenu contains the following settings. Follow the explanations in the Upper Menu Line on the bottom of your screen to change the settings.

**Display Language:** Sets the language in which the OSD menus are shown on your screen.

**Preferred Subtitle Language:** Defines your preferred subtitle language. Every time a disc will be played that contains this subtitle language, it will be shown automatically. If you do not find your preferred language in the list of options, you can select your preferred language by typing a 4-digit code found in the code list on page 20. You can also set the preferred subtitle language to OFF. In that case no subtitles will be shown.

**Panel Time-Out:** Sets the time-out interval for the Front Panel Information Display. After the selected time, the display will dim completely.

**Status Bar Time-Out:** Sets the time-out interval for the Status Bar, after which the Status Bar will disappear from the screen.

**Parental Control:** Defines a password used to control viewing of restricted programs. The default password is 8888. After pressing the default password, either the parental control setting can be chosen, or a new password. The five standard US rating symbols are "G" (General, level 2), "PG" (Parental Guidance, level 4), "PG13" (Parental Guidance and 13 years old, level 4), "R" (Restricted, level 6) and "NC 17" (from 17 years old, level 7). The DVD will accommodate a total of eight rating steps, as set by the DVD creators. These additional steps allow for more critical control of program playback for all audiences. Level 8: All DVDs can be played. Levels 7 to 2: DVDs for general audiences/ children can be played. Level 1: DVDs for children can be played; DVDs for adults/general audiences are prohibited. Follow the explanations on the screen to set a new password.

**PBC Support:** Activates PBC (Play Back Control) Support for VCD discs.

**Screen Save:** Activates a Screen Saver to prevent an image to "burn" into a video display device. If you connect the DVD 22 to a LCD or plasma screen or video projector, we recommend you activate the screen saver at all times.

**Show Angle Icon:** Determines whether the Angle Icon will appear on the screen when there are different angles available on a DVD disc.

# System Setup

## Audio Settings



The Audio Setting Submenu contains the following settings. Follow the explanations in the Upper Menu Line on the bottom of your screen to change the settings.

**Preferred Audio Language:** Defines your preferred audio language. Every time a disc is played that contains this audio language, it will be activated automatically. If you do not find your preferred language in the list of options, you can select your preferred language by typing a 4-digit code found in the code list on page 20.

**Digital Output:** If your system includes 5.1 digital audio surround decoding (Dolby Digital and/or DTS), select ORIGINAL as the digital output. In that case all audio signals will be output with their original format. If your system only includes stereo and/or Dolby Pro Logic, select PCM. Then all audio signals will be output in PCM format only (DTS will output no signal).

**PCM Limit:** The DVD 22 is compatible with both 48 kHz and 96 kHz sampling, but some early A/V receivers and surround processors are not. If your A/V receiver or surround processor is NOT capable of handling 96 kHz signals, select the 48 kHz option. If your A/V receiver or surround processor IS capable of handling 96 kHz signals, select the 96 kHz option to achieve the greatest audio fidelity available. If NONE is selected, the complete signal will be passed through to your A/V Receiver or surround processor.

**Dynamic Range:** This setting enables Dolby Digital recordings to be played back with full dialogue intelligibility while reducing peak levels. This smooth level compression prevents abrupt loud transitions from disturbing others without reducing the impact of the digital source perceptibly.

## Video Settings



The Video Setting Submenu contains the following settings. Follow the explanations in the Upper Menu Line on the bottom of your screen to change the settings.

**Aspect Ratio:** This step selects the TV aspect ratio, conventional screen shape (4:3) or widescreen (16:9), according to your TV.

**TV Standard:** Sets the output video format i.e. NTSC, PAL or SECAM, of the DVD player. If you have a multi standard TV, we recommend the AUTO setting for optimal picture quality.

**Scan Type:** Sets the video output to Interlace or Progressive. Before changing the setting to Progressive, make sure that your video display is capable of handling progressive scan signals. As soon as you select progressive scan the scan type, the Video Output will automatically change to Component.

**Video Output:** Sets the video output type to Scart or Component. Scart will be used for most TV's. Component will be used for most LCD, Plasma and projectors.

**Scart Output:** Selects which kind of video output signals will be routed over the scart. RGB will be used for most TV's.

**Video Mode:** This setting affects only the Component Video Outputs, and it controls how the video signals are optimized for progressive scan display. In most cases, the "automatic" mode is your best choice, as it senses whether the disc being played was originally recorded on video or shot on film. However, in some cases you may wish to compensate for errors in the disc authoring that occur when the frame rate is not properly maintained when films are converted to video. Three choices are available:

- **Auto:** This is the recommended setting, as it lets the DVD 22 analyze the signals from the DVD and adjust the output accordingly.
- **Movie:** Choose this option for optimal playback of material that was shot on film, even though you are viewing it on video via a DVD.
- **Video:** Choose this option for optimal playback of material that was shot directly to video, such as concerts and sports programming.

## Video Adjustment

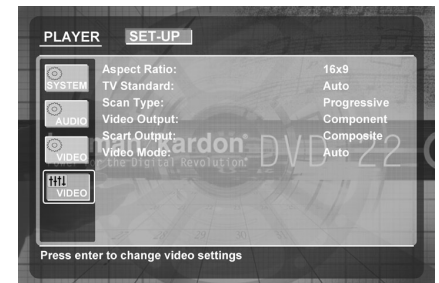

The Video Adjustment Submenu contains access to the Test Screen. First adjust the video display device (TV) with the help of the Test Screen. After that the output settings of the player can be fine-tuned with the Color, Contrast, Brightness, Tint and Black Level settings. In order to change the settings, move the cursor to the "+" or "-" icon on the same line as the setting. Once one of the icons is highlighted, pressing ENTER will increase or decrease the value of the setting, as will be shown in the bar behind the setting. To exit the Video Adjustment Menu, move the cursor to DONE, and press ENTER.



# Test Screen

## Test Screen

When you activate the Test Screen via the OSD you can activate a still image to test all settings and the video performance of your TV. With the vertical color bars you can test the following:

- proper color intensity setting on your TV,
- the proper color of each bar, showing if the proper video standard is turned on: the colors should be (left to right): black, white, yellow, cyan (turquoise), green, magenta (purple), red, blue, black.
- proper color transition, seen as sharp separation of the bars, S-Video will be better than Video, RGB best of all.
- the performance of the color filter in your TV (with "Video" signals), bar edges should show no vertical crawling dots. Here S-Video and RGB formats usually give no problems.

With the grey scale and the black/white fields below the color bars the brightness and contrast of your screen can be adjusted optimally, see chapter "TV Picture Adjustment" below.

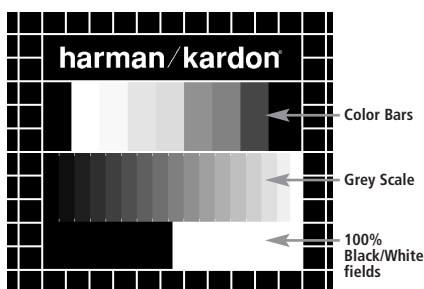

## TV Picture Adjustment with Test Screen

These adjustments may be done now, but you can also make them after setup has been finalized.

### Brightness adjustment:

1. Turn down the color control on your TV until the color bars are visible in black and white.
2. Adjust the contrast to the lowest level where you still can see all bars within the grey scale in the test picture separately and clearly.
3. Adjust the Brightness so that the bars in the grey scale are all visible. The bar furthest to the left has to be as black as possible rather than grey but the next aside must clearly be differable. All the bars in the grey scale have to be gradually and evenly changing from black to whiter, going from left to right.

### Contrast adjustment:

1. Adjust the contrast on your TV until you see a bright white bar in the right low corner of the screen and a deep dark black bar at the left. The optimal contrast setting will depend from your preference and the surrounding light in the TV room.
2. If the brightness of the white bar will no more increase while turning up the contrast or when the borders of the white "harman/kardon" text letters on top will bloom (overlight) into the black areas, what drastically will decrease the sharpness of the script, then the Contrast has been turned up too much. Reduce the contrast until these effects will disappear and the video still looks realistic.
3. If you are watching TV with a usual surrounding daylight, adjust the Contrast so that a normal video picture has about the same looking as the surroundings in your room. By that way the eye is relaxed when watching the TV picture. This contrast setting may be reduced when the surrounding light is dimmed, usually improving the sharpness of a video a lot thereby.
4. The grey scale in the middle line needs to have the same clear difference between each bar as before the contrast adjustment. If not, go back to the brightness adjustment and repeat step 3 and then the contrast adjustments, making only minor adjustments each time for optimisation.

### Color adjustment.

1. When the Brightness and the Contrast are set optimally, turn up the color control to the level of your preference. Adjust to the level where the colors look strong but still natural, not overdone. If the color level is too high, depending from the TV used some of the bars will seem wider or the color intensity will not increase while the control is turned up. Then the color control must be reduced again. At the end you should test the color intensity also with a video, e.g. pictures of natural faces, flowers, fruit and vegetables and other well known natural articles of our life most usefull for an optimal setting of the color intensity.
2. If your TV has a Tint option (with most European TVs this is available or effective only with NTSC signals, not with PAL), use the large white bar below the Greyscale to tweak the warmth of the picture. Every viewer has a difference in preference as how the glow of the picture should be. Some prefer a little colder picture, some a warmer glow. The Tint function on your TV and the white bar can be used to control this. Adjust the Tint to the level where you feel the white color has the tone you prefer.

# Player Menu

## Using the Status Bar Menu

The on-screen Status Bar contains many playback features. To see the Status Banner Menu, press STATUS on the remote control while a disc is playing. Use the ARROW buttons on the remote to move through the different features in the Status Bar. When a feature is highlighted, press ENTER on the remote to select it and to change it with the help of the options listed on the screen. Press ENTER to activate the change.

**Title:** The number shown indicates the number of the title that is currently playing.

**Chapter:** The number shown indicates the number of the chapter that is currently playing on a disc.

**Time:** This item displays the time in DVD mode.

**Press the ARROW step by step to activate:** Title Elapsed, Title Remaining, Chapter Elapsed, Chapter Remaining. Depending on the choice made, the bar will show a graphic view on where the disc is currently playing.

## PLAYER Menu



Once all the settings have been made, you are ready to enjoy your DVD 22. Once you have inserted a disc into the drawer you can explore the other Main Menu, that is the PLAYER Menu. This menu hosts all playback and program features, as well as all disc information. As you will see, the layout of this menu is comparable with the layout of the SET-UP Menu. The functionality is the same too. The Submenus are shown on the left side of the screen, with INFO and PROGRAM activated by default. As in the SET-UP Menu, settings can be highlighted with the ARROW buttons and selected with the ENTER button on the remote control. Options for the settings are shown in the Lower Menu Line on the bottom of the screen.

**Disc:** Shows the name of the disc as it has been given by the artist

**Audio:** Shows the audio track that is currently playing. Options are shown on both Menu Lines on the bottom of the screen.

**Playlist:** Sets the order in which the current disc is played back.

**Repeat:** Sets the repeat mode.

**Random:** Activates Random Playback when possible.

**Subtitle:** Shows the subtitle of the disc currently playing.

In the PLAYER Menu, the chapter, track or picture currently playing will be marked with an arrow symbol in front of the Chapter (DVD), Track (CD, MP3, WMA) or Picture (JPEG). Chapters, tracks and pictures can be selected from this list at any time by moving the cursor to the requested chapter or track and pressing ENTER to confirm.

The top part of this screen can be de-activated to show the complete Track list on the screen. To de-activate, move the cursor to the INFO Submenu of the left side of the screen. Press ENTER until the icon is highlighted in light blue and the full Track list is visible on the screen. In the same way the Disc list can be removed from the screen by de-activating the PROGRAM Submenu.

## Information Displays



In DVD and MP3 mode, activating the DISC INFO Submenu will show information about the player and the disc currently playing. The first lines will show Disc Name and Disc ID. Below you can compare the Aspect Ratio, Video Standard and Scan Type available on the disc with the actual settings of your player.

In the lower part of the screen the Audio Resolution and Audio Format are shown, and at the bottom you will see a graphical presentation of the Video Bit Rate and the Audio Bit Rate of the disc currently playing.

## Programmed Play

In STOP mode, the Disc List can be used to create your own program list for both DVD, CD, MP3, WMA or JPEG discs. Move the cursor to the right of the menu, into the Disc List. Move the cursor up or down to the first track you would like to program and press ENTER. The cursor will move to the options in the Lower Menu Line. You can either add the selected track (or picture) to the playlist or give it the number you would like it to have in your playlist, or clear the track from the list. Move the cursor down to the next track you would like to program and continue until your playlist is complete. Once completed, move the cursor up to the Playlist setting. Select Programmed order from the options and press PLAY to start the playback.



If you have a disc that contains both MP3 files and JPEG images, you can choose to run these simultaneously, mixing the MP3 audio with your own images. The time interval can be chosen in the Picture Setting.

## DVD Language Codes

The availability of specific languages for the main audio track or subtitles is dependent on the choices made by a disc's producer. You should always consult the disc's jacket for information on languages for any disc. In the case of some languages, you may be required to enter a code from the list below to access that language.

Language	Code	Language	Code	Language	Code
Abkhazian	6566	Hungarian	7285	Russian	8285
Afar	6565	Icelandic	7383	Samoan	8377
Afrikaans	6570	Indonesian	7378	Sangho	8371
Albanian	8381	Interlingua	7365	Sanskrit	8365
Ameharic	6577	Interlingue	7369	Scots Gaelic	7168
Arabic	6582	Iunpiak	7375	Serbian	8382
Armenian	7289	Irish	7165	Servo-Groatian	8372
Assamese	6583	Italian	7384	Sesotho	8384
Aymara	6588	Japanese	7465	Setswana	8478
Azerbaijani	6590	Javanese	7487	Shona	8378
Bashkir	6665	Kannada	7578	Sindhi	8368
Basque	6985	Kashmiri	7583	Singhalese	8373
Bengali; Bangla	6678	Kazakh	7575	Siswati	8383
Bhutani	6890	Kinyarwanda	8287	Slovak	8375
Bihari	6672	Kirghiz	7589	Slovenian	8376
Bislama	6673	Kirundi	8278	Somali	8379
Breton	6682	Korean	7579	Spanish	6983
Bulgarian	6671	Kurdish	7585	Sundanese	8385
Burmese	7789	Laothian	7679	Swahili	8387
Byelorussian	6669	Latin	7665	Swedish	8386
Cambodian	7577	Latvian, Lettish	7686	Tagalog	8476
Catalan	6765	Lingala	7678	Tajik	8471
Chinese	9072	Lithuanian	7684	Tamil	8465
Corsican	6779	Macedonian	7775	Tatar	8484
Croatian	7282	Malagasy	7771	Telugu	8469
Czech	6783	Malay	7783	Thai	8472
Danish	6865	Malayalam	7776	Tibetan	6679
Dutch	7876	Maltese	7784	Tigrinya	8473
English	6978	Maori	7773	Tonga	8479
Esperanto	6979	Marathi	7782	Tsonga	8483
Estonian	6984	Moldavian	7779	Turkish	8482
Faroese	7079	Mongolian	7778	Turkmen	8475
Fiji	7074	Naru	7865	Twi	8487
Finnish	7073	Nepali	7869	Ukrainian	8575
French	7082	Norwegian	7879	Urdu	8582
Frisian	7089	Occitan	7967	Uzbek	8590
Galician	7176	Oriya	7982	Vietnamese	8673
Georgian	7565	Oromo (Afan)	7977	Volapuk	8679
German	6869	Panjabi	8065	Welsh	6789
Greek	6976	Pashto, Pushto	8083	Wolof	8779
Greenlandic	7576	Persian	7065	Xhosa	8872
Guarani	7178	Polish	8076	Yiddish	7473
Gujarati	7185	Portuguese	8084	Yoruba	8979
Hausa	7265	Quechua	8185	Zulu	9085
Hebrew	7387	Rhaero-Romance	8277		
Hindi	7273	Romanian	8279		

## Technical Specifications

<b>Applicable Disc:</b>	Disc formats: 5 inch (12 cm) or 3 inch (8 cm) DVD Video, Standard conforming DVD+RW, DVD+R, DVD-R and DVD-RW, VCD, CD, CD-R, MP3, WMA, JPEG or CD-RW discs, Regio code: DVD Video disc with Code 2 or 0 only. DVD-Layers: Single Side/Single Layer, Single Side/Dual Layer, Dual Side/Single Layer, Dual Side/Dual Layer Audio formats: Linear PCM, MPEG, MLP/CPPM, Dolby Digital or DTS
<b>Video Signal System:</b>	PAL/NTSC
<b>Composite Video Output:</b>	1 V <sub>p-p</sub> /75 Ohms, sync negative polarity
<b>S Video Output:</b>	Y/Luminance: 1 V <sub>p-p</sub> /75 Ohms, sync negative polarity C/Chrominance: 0.286 V <sub>p-p</sub>
<b>Component Video Output:</b>	Y: 1 V <sub>p-p</sub> /75 Ohms, sync negative polarity Cr: 0.7 V <sub>p-p</sub> /75 Ohms Cb: 0.7 V <sub>p-p</sub> /75 Ohms
<b>Analog Audio Output:</b>	2 V <sub>rms</sub> max
<b>Frequency Response:</b>	DVD (Linear PCM): 2 Hz - 22 kHz +0/-0.5 dB (48 kHz sampling) 2 Hz - 44 kHz +0/-0.5 dB (96 kHz sampling) CD: 2 Hz - 20 kHz +0/-0.5 dB
<b>Signal/Noise Ratio (SNR):</b>	105 dB (A-weighted)
<b>Dynamic Range:</b>	DVD: 100 dB (18 Bit)/105 dB (20 Bit) CD/DVD: 96 dB (16 Bit)
<b>THD/1kHz:</b>	DVD/CD: 0.003 %
<b>Wow &amp; Flutter:</b>	Below Measurable Limits
<b>AC Power:</b>	110 - 240 V/50 - 60 Hz
<b>Power Consumption:</b>	2 Watts (On)/20 Watts (Max)
<b>Dimensions (WxHxD):</b>	440 x 49 x 330 mm
<b>Weight:</b>	3.3 Kg

Depth measurement includes knobs and connectors.

Height measurement includes feet and chassis.

All specifications subject to change without notice.

Harman Kardon and Power for the digital revolution are trademarks of Harman Kardon, Inc.

Manufactured under license from Dolby Laboratories. Dolby, AC-3, ProLogic and the double-D symbol are trademarks of Dolby Laboratories. Confidential.

Unpublished Work. © 1992-1997 Dolby Laboratories, Inc. All rights reserved.

DTS is a trade mark of Digital Theater Systems, Inc.

Microsoft, Windows and WMA are either registered trademarks or trademarks of Microsoft Corporation in the United States and/or other countries.

This product incorporates copyright protection technology that is protected by method claims of certain U.S. patents and other intellectual property rights owned by Macrovision Corporation and other rights owners. Use of this copyright protection technology must be authorized by Macrovision Corporation and is intended for home and other limited viewing uses only unless otherwise authorized by Macrovision Corporation. Reverse engineering or disassembly is prohibited.

**CONSUMERS SHOULD NOTE THAT NOT ALL HIGH DEFINITION TELEVISION SETS ARE FULLY COMPATIBLE WITH THIS PRODUCT AND MAY CAUSE ARTIFACTS TO BE DISPLAYED IN THE PICTURE. IN CASE OF 525 OR 625 PROGRESSIVE SCAN PICTURE PROBLEMS, IT IS RECOMMENDED THAT THE USER SWITCH THE CONNECTION TO THE 'STANDARD DEFINITION' OUTPUT. IF THERE ARE QUESTIONS REGARDING OUR TV SET COMPATIBILITY WITH THIS MODEL 525p AND 625p DVD PLAYER, PLEASE CONTACT OUR CUSTOMER SERVICE CENTER.**



---

**harman/kardon**

**H** A Harman International Company  
250 Crossways Park Drive, Woodbury, New York 11797  
[www.harmankardon.com](http://www.harmankardon.com)  
Harman Consumer Group International:  
2, Route de Tours, 72500 Château-du-Loir, France  
© 2004 Harman Kardon, Incorporated  
Partnumber: 312-AB220000-0000



## Free Manuals Download Website

<http://myh66.com>

<http://usermanuals.us>

<http://www.somanuals.com>

<http://www.4manuals.cc>

<http://www.manual-lib.com>

<http://www.404manual.com>

<http://www.luxmanual.com>

<http://aubethermostatmanual.com>

Golf course search by state

<http://golfingnear.com>

Email search by domain

<http://emailbydomain.com>

Auto manuals search

<http://auto.somanuals.com>

TV manuals search

<http://tv.somanuals.com>