

Harman Kardon AVR45 Audio/Video Receiver Récepteur Audio/Vidéo

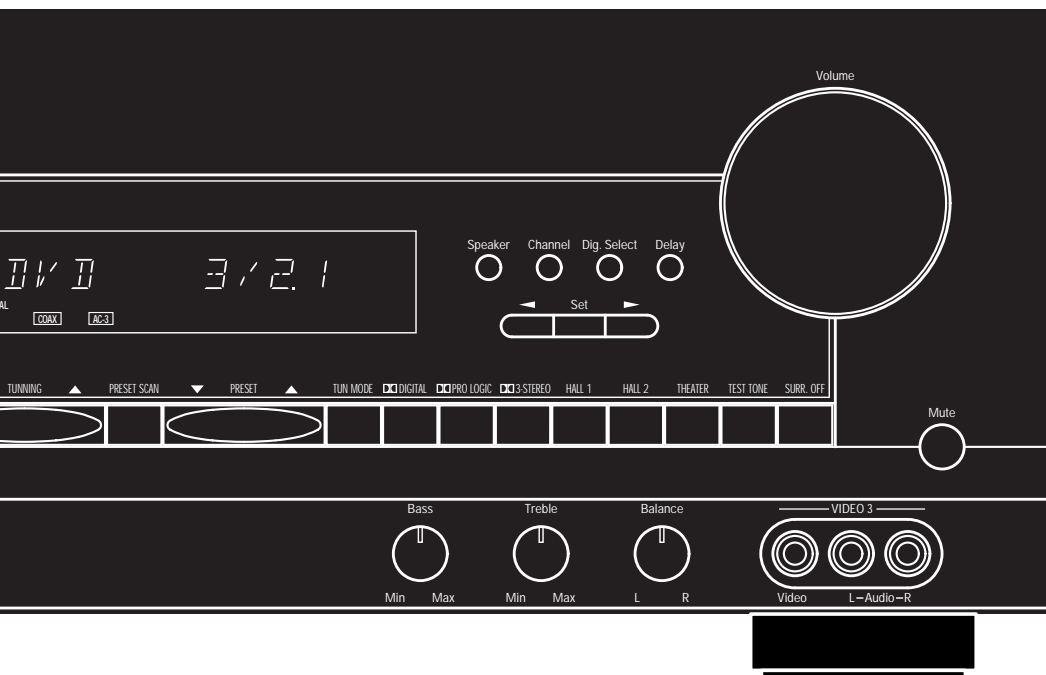

Owner's Manual Manuel de l'Utilisateur

harman/kardon

Owner's Manual

AVR45 Audio/Video Receiver

Table of Contents

Introduction	1
Safety Information	2-3
Front Panel Controls	4-6
Front Panel Information Display	7-8
Rear Panel Connections	9-10
Remote Control Functions	11-13
Installation and Connections	14-15
System Configuration	16-21
Operation	22-27
Source Selection	22
Surround Mode Selection	22-24
Surround Mode Chart	23
Digital Audio Playback	24-26
Tuner Operation	26
Tape Recording	26-27
Output Level Trim Adjustment	27
Six-Channel Direct Input	27
Programming the Remote	28-40
Direct Code Entry	28
Auto Search Method	28-29
Code Readout	29
Programmed Device Functions	29-30
Macro Programming	30-31
Volume Punch-Through	31
Re-Assigning Device Control Selectors	31
Function List	32-33
Setup Code Tables: TV	34-36
Setup Code Tables: VCR	37-38
Setup Code Tables: CD	39
Setup Code Tables: AUX (DVD)	39
Setup Code Tables: Cable	40
Setup Code Tables: SAT	40
Troubleshooting Guide	41
Technical Specifications	42

harman / kardon

250 Crossways Park Drive
Woodbury, NY 11797

H A Harman International Company

Staple or clip original invoice here. ▼

Introduction

Congratulations! With the purchase of the Harman Kardon AVR45 you are about to begin many years of listening enjoyment. The AVR45 has been custom designed to provide all the excitement and detail of movie sound tracks and every subtle nuance of musical selections. With on-board Dolby* Digital Decoding, the AVR45 delivers six discrete channels of audio that take advantage of the digital sound tracks from the latest DVD and LV releases, as well as future HDTV broadcasts.

While complex digital systems are hard at work within the AVR45 to make all of this happen, hookup and operation are simple. Color-keyed connections and a comprehensive programmable remote control make the AVR45 easy to use.

To obtain maximum enjoyment from your new receiver, we urge you to take a few minutes to read through this manual. This will ensure that connections to speakers, source playback units and other external devices are made properly. In addition, a few minutes spent learning the functions of the various controls will enable you to take advantage of all the power the AVR45 is able to deliver.

If you have any questions about this product, its installation or operation, please contact your dealer. They are your best local source of information.

Description and Features

The AVR45 is a full-featured A/V receiver, incorporating a wide variety of listening options. In addition to Dolby Digital decoding, Dolby Pro Logic* and Dolby 3 Stereo are available for compatibility with the tens of thousands of movies and television programs encoded with analog surround information. A choice of Hall and Theater modes is also available for use with both encoded sources and traditional two-channel stereo recordings.

A total of four audio/video inputs, as well as two additional audio-only inputs, and an FM stereo/FM/AM tuner are available for the utmost flexibility. Front-panel A/V inputs simplify connections to video games or camcorders.

The AVR45's powerful amplifiers use traditional Harman Kardon High-Current Design philosophies to meet the wide dynamic range of any program selection.

Harman Kardon invented the high-fidelity receiver more than forty-five years ago. With state-of-the-art features and time-honored circuit designs, the AVR45 is one of the finest receivers ever offered by Harman Kardon.

- On-Board Dolby Digital Decoding
- Coax and Optical Digital Inputs
- Five Analog Surround Modes
- Pre-Programmed Learning Remote Control With Backlit Buttons
- Composite Video Switching
- Six-Channel Direct Input Enables Seamless Integration of Future Decoding Systems
- Preamp Output for ALL Channels Permits Ease of Expansion

Safety Information

2

Important Safety Information

Verify Line Voltage Before Use

Your AVR45 has been designed for use with 120-volt AC current. Connection to a line voltage other than that for which it is intended can create a safety and fire hazard, and may damage the unit.

If you have any questions about the voltage requirements for your specific model, or about the line voltage in your area, contact your selling dealer before plugging the unit into a wall outlet.

Do Not Use Extension Cords

To avoid safety hazards, use only the power cord attached to your unit. We do not recommend that extension cords be used with this product. As with all electrical devices, do not run power cords under rugs or carpets or place heavy objects on them. Damaged power cords should be replaced immediately with cords meeting factory specifications.

Handle the AC Power Cord Gently

When disconnecting the power cord from an AC outlet, always pull the plug, never pull the cord. If you do not intend to use the unit for any considerable length of time, disconnect the plug from the AC outlet.

Do Not Open the Cabinet

There are no user-serviceable components inside this product. Opening the cabinet may present a shock hazard, and any modification to the product will void your guarantee. If water or any metal object such as a paper clip, wire or staple accidentally falls inside the unit, disconnect it from the AC power source immediately, and consult an authorized service station.

CATV or Antenna Grounding



If an outside antenna or cable system is connected to this product, be certain that it is grounded so as to provide some protection against voltage surges and static charges. Section 810 of the National Electrical Code, ANSI/NFPA No. 70-1984, provides information with respect to proper grounding of the mast and supporting structure, grounding of the lead-in wire to an antenna discharge unit, size of grounding conductors, location of antenna discharge unit, connection to grounding electrodes and requirements of the grounding electrode.

NOTE TO CATV SYSTEM INSTALLER:

This reminder is provided to call the CATV (Cable TV) system installer's attention to article 820-40 of the NEC that provides guidelines for proper grounding and, in particular, specifies that the cable ground shall be connected to the grounding system of the building, as close to the point of cable entry as possible.

Installation Location

- To assure proper operation, and to avoid the potential for safety hazards, place the unit on a firm and level surface. When placing the unit on a shelf, be certain that the shelf and any mounting hardware can support the weight of the product.
- Make certain that proper space is provided both above and below the unit for ventilation. If this product will be installed in a cabinet or other enclosed area, make certain that there is sufficient air movement within the cabinet. Under some circumstances a fan may be required.
- Do not place the unit directly on a carpeted surface.
- Avoid installation in extremely hot or cold locations, or an area that is exposed to direct sunlight or heating equipment.
- Avoid moist or humid locations.
- Do not obstruct the ventilation slots on the top of the unit, or place objects directly over them.

 CAUTION 
RISK OF ELECTRIC SHOCK
DO NOT OPEN

CAUTION: TO REDUCE THE RISK OF ELECTRIC SHOCK, DO NOT REMOVE COVER (OR BACK). NO USER-SERVICEABLE PARTS INSIDE. REFER SERVICING TO QUALIFIED SERVICE PERSONNEL.

WARNING: The lightning flash with arrowhead symbol, within an equilateral triangle, is intended to alert the user to the presence of uninsulated "dangerous voltage" within the product's enclosure that may be of sufficient magnitude to constitute a risk of electric shock to persons.

WARNING: The exclamation point within an equilateral triangle is intended to alert the user to the presence of important operating and maintenance (servicing) instructions in the literature accompanying the appliance.

WARNING: TO REDUCE THE RISK OF FIRE OR ELECTRIC SHOCK, DO NOT EXPOSE THIS APPLIANCE TO RAIN OR MOISTURE.

CAUTION: TO PREVENT ELECTRIC SHOCK, MATCH WIDE BLADE OF PLUG TO WIDE SLOT, FULLY INSERT.
ATTENTION: POUR EVITER LES CHOCS ELECTRIQUES, INTRODUIRE LA LAME LA PLUS LARGE DE LA FICHE DANS LA BORNE CORRESPONDANTE DE LA PRISE ET POUSSER JUSQU'AU FOND.

Safety Information

Cleaning

When the unit gets dirty, wipe it with a clean, soft, dry cloth. If necessary, wipe it with a soft cloth dampened with mild soapy water, then a fresh cloth with clean water. Wipe dry immediately with a dry cloth. NEVER use benzene, aerosol cleaners, thinner, alcohol or any other volatile cleaning agent. Do not use abrasive cleaners, as they may damage the finish of metal parts. Avoid spraying insecticide near the unit.

Moving the Unit

Before moving the unit, be certain to disconnect any interconnection cords with other components, and make certain that you disconnect the unit from the AC outlet.

Important Information For the User

NOTE: This equipment has been tested and found to comply with the limits for a Class-B digital device, pursuant to Part 15 of the FCC Rules. The limits are designed to provide reasonable protection against harmful interference in a residential installation. This equipment generates, uses and can radiate radio-frequency energy and, if not installed and used in accordance with the instructions, may cause harmful interference to radio communication. However, there is no guarantee that harmful interference will not occur in a particular installation. If this equipment does cause harmful interference to radio or television reception, which can be determined by turning the equipment off and on, the user is encouraged to try to correct the interference by one or more of the following measures:

- Reorient or relocate the receiving antenna.
- Increase the separation between the equipment and receiver.
- Connect the equipment into an outlet on a circuit different from that to which the receiver is connected.
- Consult the dealer or an experienced radio/TV technician for help.

This device complies with Part 15 of the FCC Rules. Operation is subject to the following two conditions: (1) this device may not cause harmful interference, and (2) this device must accept interference received, including interference that may cause undesired operation.

NOTE: Changes or modifications may cause this unit to fail to comply with Part 15 of the FCC Rules and may void the user's authority to operate the equipment.

Unpacking

The carton and shipping materials used to protect your new receiver during shipment were specially designed to cushion it from shock and vibration. We suggest that you save the carton and packing materials for use in shipping if you move, or should the unit ever need repair.

To minimize the size of the carton in storage, you may wish to flatten it. This is done by carefully slitting the tape seams on the bottom and collapsing the carton down to a more two-dimensional appearance. Other cardboard inserts may be stored in the same manner. Packing materials that cannot be collapsed should be saved along with the carton in a plastic bag.

If you do not wish to save the packaging materials, please note that the carton and other sections of the shipping protection are recyclable. Please respect the environment and discard those materials at a local recycling center.

Typographic Conventions

In order to help you use this manual with the remote control, front panel controls and rear panel connections, certain conventions have been used.

EXAMPLE – (bold type) indicates a specific remote control or front panel button, or rear panel connection jack

EXAMPLE – (OCR type) indicates a message that is visible on the front panel information display

EXAMPLE – (bold type) indicates a lit indicator in the front panel information display

1 – (number in a square) indicates a specific front panel control

1 – (number in an oval) indicates a button or indicator on the remote

1 – (number in a circle) indicates a rear panel connection

A – (letter in a square) indicates an indicator in the front panel display

Front Panel Controls

4

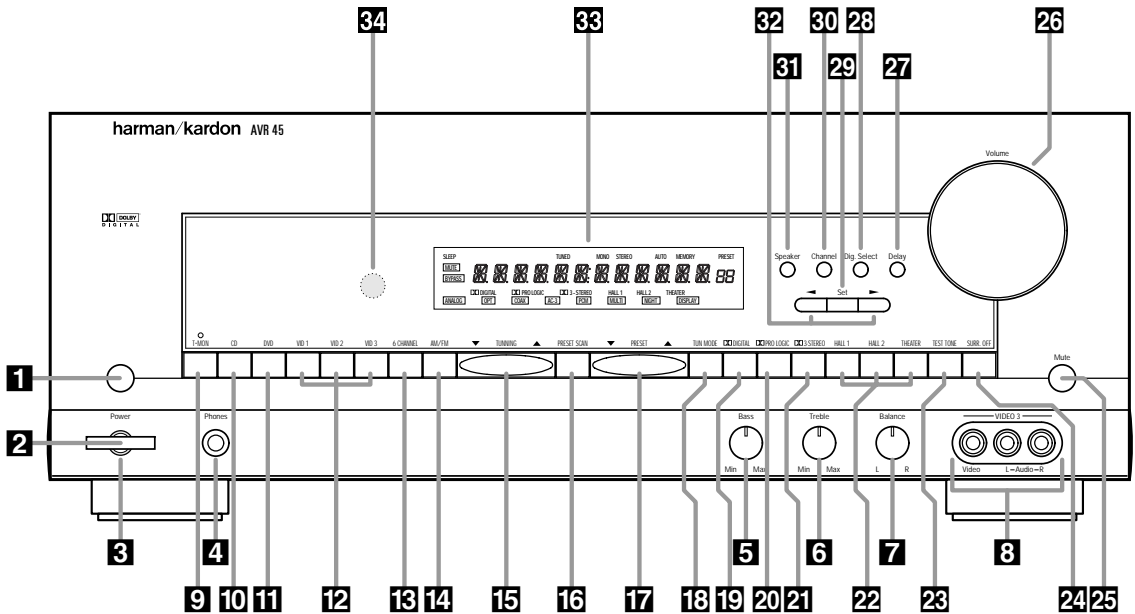

- 1** Main Power Switch
- 2** System Power Control
- 3** Power Indicator
- 4** Headphone Jack
- 5** Bass Control
- 6** Treble Control
- 7** Balance Control
- 8** Video 3 Inputs
- 9** T-Mon Selector
- 10** CD
- 11** DVD Input
- 12** Video Input Selectors

- 13** 6-Channel Direct Selector
- 14** AM/FM
- 15** Tuning Button
- 16** Preset Scan
- 17** Preset Stations Selector
- 18** Tune Mode
- 19** Dolby Digital Selector
- 20** Dolby Pro Logic Selector
- 21** Dolby 3 Stereo Selector
- 22** Analog Surround Mode Selectors
- 23** Test Tone
- 24** Surround Off

- 25** Mute
- 26** Volume Control
- 27** Delay
- 28** Digital Input Selector
- 29** Set Button
- 30** Channel Select
- 31** Speaker Select Button
- 32** Selector Buttons
- 33** Information Display
- 34** Remote Sensor Window

Front Panel Controls

5

1 Main Power Switch: Press this button to apply power to the AVR45. When the switch is pressed in the unit is placed in a Standby mode, as indicated by the amber LED **3** surrounding the **System Power control 2**. This button MUST be pressed in to operate the unit. To turn the unit off and prevent the use of the remote control, this switch should be press this switch until it pops out from the front panel so that the word "OFF" may be read at the top of the switch.

NOTE: In normal operation this switch is left in the "ON" position.

2 System Power Control: When the **Main Power Switch 1** is "ON," press this button to turn on the AVR45; press it again to turn the unit off. Note that the **Power Indicator** surrounding the switch **3** will turn green when the unit is on.

3 Power Indicator: This LED will illuminate in amber when the unit is in the Standby mode to signal that the unit is ready to be turned on. When the unit is in operation, the indicator will turn green.

4 Headphone Jack: This jack may be used to listen to the AVR45's output through a pair of headphones. Be certain that the headphones have a standard 1/4" stereo phone plug.

5 Bass Control: Turn this control to modify the low-frequency output of the left/right channels by as much as ± 10 dB. Set this control to a suitable position for your taste and room acoustics.

6 Treble Control: Turn this control to modify the high-frequency output of the left/right channels by as much as ± 10 dB. Set this control to a suitable position for your taste and room acoustics.

7 Balance Control: Turn this control to change the relative volume for the front left/right channels.

NOTE: For proper operation of the surround modes this control should be at the midpoint, or "12 o'clock" position.

8 Video 3 Inputs: These audio/video inputs may be used for temporary connection of video games, camcorders, digital still cameras or portable audio products. To select a source connected to these jacks, press the **Vid 3 Input Selector 12**.

9 T•Mon Selector: Press this button to select the device connected to the **Tape Monitor** jacks **2** as the listening source. The previously selected source will continue to show in the **Information Display 33**, and the red LED above the button will illuminate to remind you that you are listening to the tape monitor output.

10 CD: Press this button to select the device connected to the **CD Input** jacks **6** as the listening source.

11 DVD Input: Press this button to select the device connected to the **DVD Play** jacks **7** as the listening and viewing source.

12 Video Input Selectors: Press one of these buttons to select a source connected to the rear panel **Audio/Video** inputs **3 16**, or the front panel **Audio/Video** input **8**.

13 6-Channel Direct Selector: Press this button to select the output of an optional, external 6-channel decoder connected to the **6 Ch Direct** inputs **5** as the listening source.

14 AM/FM: Press this button to select the tuner as the AVR45's input source. When it is first pressed the last station tuned will be heard. Press it again to change between AM and FM bands.

15 Tuning Button: Press the left side of the button to tune lower frequency stations and the right side of the button to tune higher frequency stations. When a station with a strong signal is reached, the **TUNED** indicator **14** will illuminate in the **Information Display 33**.

16 Preset Scan: Press this button to automatically scan through the stations that have been programmed in the AVR45's memory. The tuner will play five seconds of each station before moving to the next preset station. To stop the scan when the desired station is heard, press the button again. (See page 26 for more information on the tuner memory system.)

Front Panel Controls

6

17 Preset Stations Selector: Press this button to select stations that have been entered into the preset memory. (See page 26 for more information on tuner programming.)

18 Tune Mode: Press this button to select the stereo or mono mode for FM tuning. In the STEREO mode a **Stereo** indicator **P** will illuminate in the information display, and stereo reception will be provided when stations are transmitting stereo signals. In the MONO mode the left and right signals from stereo broadcasts will be mixed together and reproduced through all channels. Select MONO for better reception of weak signals.

19 Dolby Digital Selector: Press this button to select the Dolby Digital surround mode when listening to a program that carries the Dolby Digital information. (See pages 22–25 for more information on surround modes and digital audio.)

20 Dolby Pro Logic Selector: Press this button to select the Dolby Pro Logic surround mode when listening to an analog program that is encoded with surround-sound information. (See pages 22–25 for more information on surround modes.)

21 Dolby 3 Stereo Selector: Press this button to select the Dolby 3 Stereo listening mode. This mode is used primarily when a program has surround information when a center channel speaker, but no surround speakers, is installed. (See pages 22–25 for more information on surround modes.)

22 Analog Surround Mode Selectors: Press one of these buttons to select the analog surround modes. These modes may be used with any analog program source to create a pleasing surround effect. (See pages 22–25 for more information on surround modes.)

23 Test Tone: Press this button to begin the sequence of steps used to set the AVR45's output levels. When this button is pressed, a test tone will replace the currently selected listening source. (See page 19 for more information on using the test tone to set the output levels.)

24 Surround Off: Press this button to turn off all surround processing, and to listen to a program in traditional stereo from the left front and right front speakers only.

25 Mute: Press this button to momentarily silence the speaker output of the AVR45.

26 Volume Control: Turn the knob clockwise to increase volume, counterclockwise to decrease the volume.

27 Delay: Press this button to begin the sequence of steps required to enter delay time settings. (See page 20 for more information on delay times.)

28 Digital Input Selector: When playing a source that has a digital output, press this button to select between the **Optical 19** and **Coaxial 18 Digital** inputs. (See pages 22–25 for more information on digital audio.)

29 Set Button: When making choices during the setup and configuration process, press this button to enter the desired setting, as shown in the **Information Display 33**, into the AVR45's memory. (See pages 17–24 for more information on setup and configuration.)

30 Channel Select: Press this button to begin the process of selecting and configuring the AVR45's output channels. (See pages 17–24 for more information on setup and configuration.)

31 Speaker Select Button: Press this button to begin the process of selecting the speaker positions that are used in your listening room. (See pages 17–24 for more information on setup and configuration.)

32 Selector Buttons: When you are establishing the AVR45's configuration settings, use these buttons to select between the choices available, as shown in the **Information Display 33**.

33 Information Display: This display delivers messages and status indications to help you operate the receiver. (See page 7 for a complete explanation of the Information Display.)

34 Remote Sensor Window: The sensor behind this window receives infrared signals from the remote control. Aim the remote at this area and do not block or cover it unless an external remote sensor is installed.

Front Panel Information Display

7

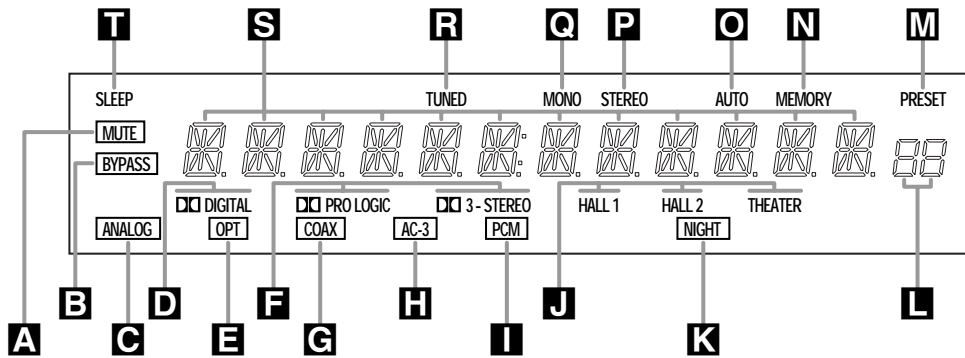

- | | | |
|--|--|-----------------------------------|
| A Mute | H AC-3 Indicator | O Auto |
| B Bypass | I PCM Indicator | P Stereo Indicator |
| C Analog | J Analog Surround Mode Indicators | Q Mono Indicator |
| D Dolby Digital Indicator | K Night Indicator | R Tuned Indicator |
| E Optical Source | L Preset Number | S Main Information Display |
| F Analog Dolby Surround Mode Indicators | M Preset Indicator | T Sleep Indicator |
| G Coax Source | N Memory | |

Front Panel Information Display

8

A Mute: This indicator illuminates to remind you that the AVR45's output has been silenced by pressing the **Mute** button **25** . Press the Mute button again to return to the previously selected output level.

B Bypass: This indicator illuminates when the surround processing has been disabled by pressing the **Surround Off** button **24** . When this indicator is lit, the AVR45 will play traditional stereo sound using the front left and front right speakers only.

C Analog: This indicator illuminates when an analog input source is in use.

D Dolby Digital Indicator: This indicator illuminates when a Dolby Digital source is being played.

E Optical Source: This indicator illuminates when a digital source is in use via a connection to the **Optical Digital** input **19** .

F Analog Dolby Surround Mode Indicators: These indicators illuminate when one of the analog (matrix) Dolby Surround modes is in use.

G Coax Source: This indicator illuminates when a digital source is in use via a connection to the **Coaxial Digital** input **18** .

H AC-3* Indicator: This indicator illuminates when the AVR45 is decoding a Dolby Digital input source.

I PCM Indicator: This indicator illuminates to show that a standard PCM (SP/DIF) digital audio signal is being decoded by the digital-to-analog converter.

J Analog Surround Mode Indicators: These indicators illuminate when one of the DSP generated analog surround modes is in use with an analog input source.

K Night Indicator: This indicator lights when the AVR45 is in the Night mode, which prevents the AVR45 from loud playback when digital sources are in use.

L Preset Number: This two-digit display indicates the station preset number that is currently in use, or that is being entered.

M Preset Indicator: This indicator illuminates when one of the stations entered into the preset memory is tuned. The number that appears below the indicator is the preset station's memory.

N Memory: This indicator flashes when entering presets and other information into the tuner's memory.

O Auto: This indicator illuminates when the "Auto" mode is in use for FM tuning.

P Stereo Indicator: This indicator illuminates when an FM station is being tuned in stereo.

Q Mono Indicator: This indicator illuminates when the tuner has been placed in the monaural mode by pressing the **Tune Mode** button **18** . Set the tuner for mono listening to cut noise and improve the quality of distant stereo signals.

R Tuned Indicator: This indicator illuminates when a station is being received with sufficient signal strength to allow for acceptable listening quality.

S Main Information Display: This display shows messages relating to the status, input source, surround mode, tuner, volume level or other aspects of unit's operation.

T Sleep Indicator: This indicator is illuminated when the Sleep function is in use. The number that appears above the indicator is the number of minutes remaining before the AVR45 will return to the Standby mode.

Rear Panel Connections

9

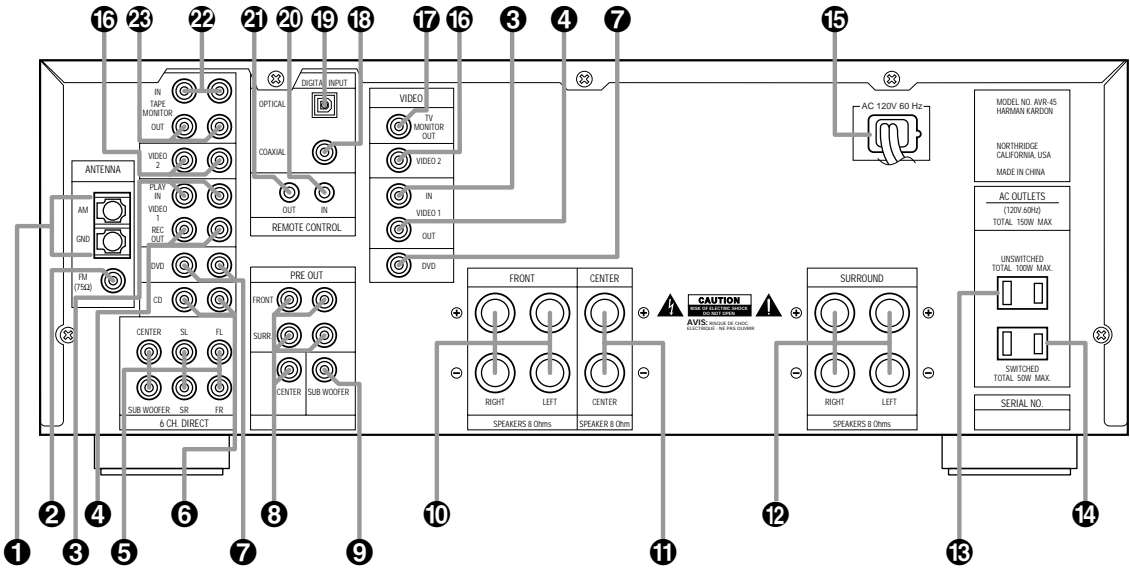

- 1 AM Antenna
- 2 FM Antenna
- 3 Video 1 Inputs
- 4 Video 1 Outputs
- 5 6-Channel Direct Inputs
- 6 CD Inputs
- 7 DVD Inputs
- 8 Pre-Outs

- 9 Subwoofer Pre-Out
- 10 Front
- 11 Center
- 12 Surround
- 13 Unswitched AC Outlet
- 14 Switched AC Outlet
- 15 Power Cable
- 16 Video 2 Inputs

- 17 TV Monitor Video Output
- 18 AC-3/PCM Coaxial Input
- 19 AC-3/PCM Optical Input
- 20 Remote IR In
- 21 Remote IR Out
- 22 Tape Monitor In
- 23 Tape Monitor Out

1 AM Antenna: Connect the AM loop antenna supplied with the receiver to these terminals. If an external AM antenna is used, make connections to the **AM** and **GND** terminals in accordance with the instructions supplied with the antenna.

2 FM Antenna: Connect an indoor or external FM antenna to this terminal.

3 Video 1 Inputs: Connect these jacks to the audio and video PLAY/OUT jacks of a VCR.

4 Video Outputs 1: Connect these jacks to the audio and video RECORD/IN jacks of a VCR.

5 6-Channel Direct Inputs: If an external digital audio decoder is used for 5.1 (Dolby AC-3) audio, connect the outputs of that decoder to these terminals.

6 CD Inputs: Connect these jacks to the output of a compact disc player or CD changer.

7 DVD Inputs: Connect the analog audio outputs and composite video output of a DVD or LV player to these jacks.

8 Pre-Outs: If external power amplifiers are used for any channels, connect them to these jacks.

Rear Panel Connections

10

9 Subwoofer Pre-Out: Connect this jack to the line level input of a powered subwoofer. If an external subwoofer amplifier is used, connect this jack to the subwoofer amplifier input.

10 Front: Connect these terminals to the front left/right speakers.

11 Center: Connect these terminals to the center speaker.

12 Surround: Connect these terminals to the surround speakers.

13 Unswitched AC Outlet: This outlet may be used to power any AC device. The power will remain on at this outlet regardless of whether the AVR45 is on or off.

NOTE: The power consumption of the device plugged into each of these outlets should not exceed 100 watts.

14 Switched AC Outlet: This outlet may be used to power any device that you wish to have turn on when the unit is turned on with the **System Power Control** switch **2**.

15 Power Cable: Connect the AC plug to a non-switched AC wall output

16 Video 2 Inputs: Connect these jacks to the audio and video outputs of a TV Tuner, Cable TV converter box, satellite receiver or any other audio/video source.

17 TV Monitor Video Output: Connect this jack to the standard (composite) video input of a TV monitor or video projector to view the on-screen menus and the output of any standard video source selected by the receiver's video switcher.

18 AC-3/PCM Coaxial Input: Connect the coax digital output from a DVD player, HDTV receiver, LV player or CD player to this jack. The signal may be either a Dolby Digital (AC-3) signal or a standard PCM digital source.

19 AC-3/PCM Optical Input: Connect the optical digital output from a DVD player, HDTV receiver, LV player or CD player to this jack. The signal may be either a Dolby Digital (AC-3) signal or a standard PCM digital source.

20 Remote IR In: If the AVR45's front panel IR sensor is blocked due to cabinet doors or other obstructions, an external IR sensor may be used. Connect the output of the sensor to this jack.

21 Remote IR Out: This connection permits the IR sensor in the receiver to serve other remote controlled devices. Connect this jack to the "IR IN" jack on Harman Kardon or other compatible equipment.

22 Tape Monitor In: Connect these jacks to the PLAY/OUT jacks of an audio recorder.

23 Tape Monitor Out: Connect these jacks to the RECORD/INPUT jacks of an audio recorder.

Remote Control Functions

11

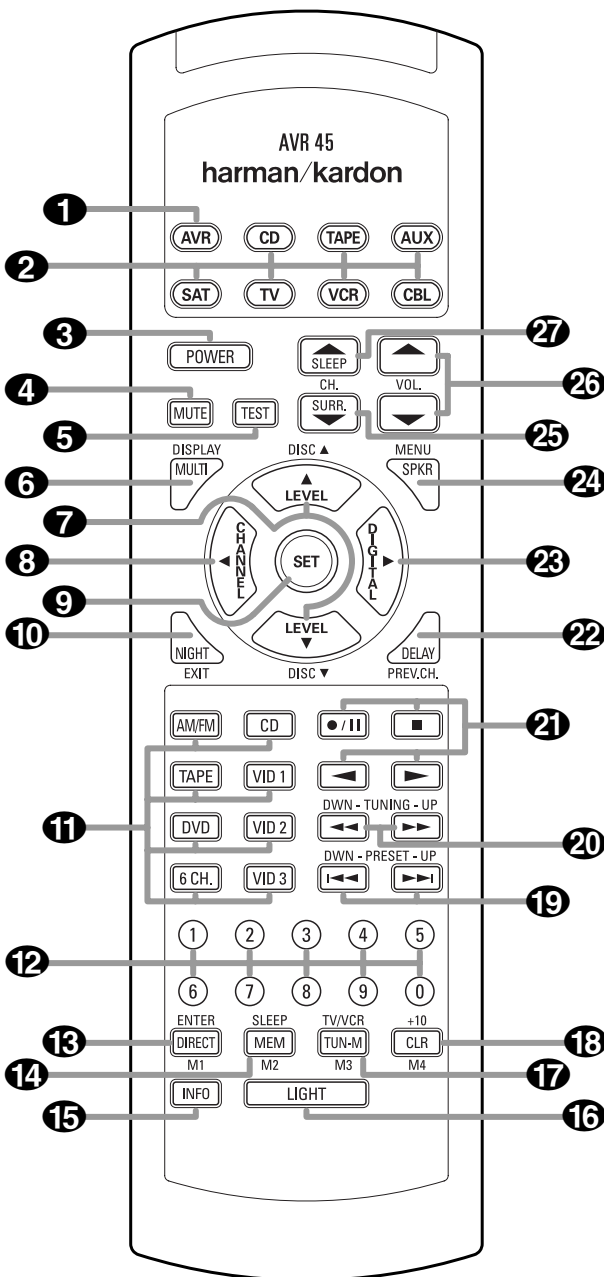

- ❶ AVR Selector
- ❷ Device Control Selectors
- ❸ Power Button
- ❹ Mute
- ❺ Test
- ❻ Display/Multiroom
- ❼ ▲/▼ Buttons
- ❽ ◀/Channel Button
- ❾ Set Button
- ❿ Night Mode
- ⓫ Source Selectors
- ⓬ Numeric Keys
- ⓭ Direct/Enter
- ⓮ Memory Button
- ⓯ Info Button
- ⓰ Light Button
- ⓱ Tuner Mode
- ⓲ Clear Button
- ⓳ Preset Up/Down
- ⓴ Tuning Up/Down
- ⓵ Transport Controls
- ⓶ Delay/Prev Ch.
- ⓷ ►/Digital Button
- ⓸ Speaker Configuration
- ⓹ Surround Mode Selector
- ⓺ Volume
- ⓻ Sleep Button

Remote Control Functions

12

IMPORTANT NOTE: The AVR45's remote may be programmed to control up to eight devices, including the AVR45. Before using the remote, it is important to remember to press the **Device Control Selector** button **1** **2** that corresponds to the unit you wish to operate. In addition, the AVR45's remote is shipped from the factory to operate the AVR45 and Harman Kardon CD players and cassette decks. The remote is also capable of operating a wide variety of other products using the control codes that are part of the remote. Before using the remote with other products, follow the instructions on pages 28–29 to program the proper codes for the products in your system.

It is also important to remember that many of the buttons on the remote take on different functions, depending on the product selected using the Device Control Selectors. The descriptions shown here primarily detail the functions of the remote when it is used to operate the AVR45. (See pages 28–31 for information about alternate functions for the remote's buttons.)

1 AVR Selector: Press this button to use the remote control for operation of the AVR45. Note that the button will briefly turn red after it has been pressed to confirm your selection.

2 Device Control Selectors: Press one of these buttons to use the remote to control the functions of another audio/video device. Note that the button will briefly turn red after it has been pressed to confirm your selection. (See pages 28–29 for information on programming the AVR45's remote to operate these devices.)

3 Power Button: Press this button to turn the currently selected device on or off.

4 Mute: Press this button to momentarily silence the AVR45 or TV set being controlled, depending on which device has been selected.

When the AVR45 remote is being programmed to operate another device, this button is pressed with the **Device Control Selector** button **2** to begin the programming process. (See page 28 for more information on programming the remote.)

5 Test: Press this button to begin the sequence used to calibrate the AVR45's output levels. (See page 19 for more information on calibrating the AVR45.)

6 Display/Multiroom Button: This button does not function with the AVR45, but it is available for use with other devices.

7 ▲/▼ Buttons: These are multi-purpose buttons. They will be used most frequently to select a surround mode. To change the surround mode, first press the **SURR/CH ▼** button **25**. Next press these buttons to scroll up or down through the list of surround modes that appear in the **Information Display 88**. (See page 24 for more information.) These buttons are also used to increase or decrease output levels used to lower the AVR45's output levels when configuring the unit with either the internal test tone or and external source. (See pages 19 and 26 for more information.) They are also used to enter delay time settings after the **Delay** button **22** has been pressed. (See page 20 for more information.)

8 ◀/Channel Button: This button is used to start the process of setting the AVR45's output levels to an external source. Once this button is pressed, use the **▲/▼** buttons **7** to select the channel being adjusted, then press the **Set** button **9**, followed by the **▲/▼** buttons again to change the level letting. (See page 27 for more information.)

9 Set Button: This button is used to enter settings into the AVR45's memory. It is also used in the setup procedures for delay time, speaker configuration and channel output level adjustment. (See pages 17–21 for complete information.)

10 Night Mode: Press this button to activate the "Night" mode, preventing loud playback when the digital modes are in use without altering the dynamic range of the output signal.

When the AVR45 remote is being programmed to operate other devices, this button is pressed to begin a readout of a programmed code. (See page 28 for more information.)

11 Source Selectors: Press these buttons to select an input source for the AVR45. The AM/FM button is also used to switch between frequency bands when the tuner is in use.

NOTE: Pressing one of these buttons selects the source only. In order to control the actual source machine using the remote you must press the **Device Control Selector** button **2** for the desired product.

12 Numeric Keys: These buttons serve as a ten-button numeric keypad to enter tuner preset positions. They are also to be used to select channel numbers when **TV** has been selected on the remote, or to select track numbers on a CD, DVD or LD player, depending on how the remote has been programmed.

NOTE: The **0** button has a dual function. It also serves as the **CLEAR** button for use in programming the tuner or clearing the system memory.

13 Direct/Enter: Press this button to select a radio station by entering its frequency using the **Numeric Keys 12**. (See page 26 for more information.)

Remote Control Functions

13

14 Memory Button: Press this button to enter a radio station into the AVR45's preset memory. After pressing the button the **MEMORY** indicator **N** will flash, and you then have five seconds to enter a present memory location using the **Numeric Keys** **12**. (See page 26 for more information.)

NOTE: Although the word "Sleep" appears above this button, it refers to control of devices other than the AVR45. Use the **Sleep** button **27** to control the AVR45's Sleep function.

15 Info Button: This button does not function with the AVR45, but it is available for use with other devices.

16 Light Button: Press this button to activate the remote's built-in back-light for better legibility of the buttons in a darkened room.

17 Tuner Mode: Press this button when the tuner is in use to select between automatic tuning and manual tuning. When the button is pressed so that the **AUTO** indicator **O** goes out, pressing the **Tuning** buttons **20** will move the frequency up or down in single-step increments. When the FM band is in use, pressing this button when a station's signal is weak will change to monaural reception, as indicated by the **MONO** indicator **Q**. (See page 26 for more information.)

18 Clear Button: This button does not function with the AVR45, but it is available for use with other devices.

19 Preset Up/Down: When the tuner is in use, these buttons scroll through the stations that have been programmed into the AVR45's memory. When many source devices, such as CD players, VCRs and cassette decks, are selected using the **Device Control Selectors** **2**, these buttons will normally function as chapter step or track advance.

20 Tuning Up/Down: When the tuner is in use, these buttons will tune up or down through the selected frequency band. If the **Tuner Mode** button **17** has been pressed so that the **AUTO** indicator **O** is illuminated, pressing these buttons will cause the tuner to seek the next station with acceptable signal strength for quality reception. When the **AUTO** indicator **O** is NOT illuminated, pressing these buttons will tune stations in single-step increments. (See page 26 for more information.)

21 Transport Controls: These controls do not control any functions of the AVR45, but they are used extensively when operating a wide variety of CD players, cassette decks and VCRs. (See page 28 for information on programming the remote to utilize these buttons.)

22 Delay/Prev Ch.: Press this button to begin the process for setting the delay times used by the AVR45 when processing surround sound. After pressing this button the delay times are entered by pressing the **Set** button **9**, and then using the **▲/▼** buttons **7** to change the setting. Press the Set button again to complete the process. (See page 20 for more information.)

23 ►/Digital Button: This button is used to select the type of digital input used with any one of the input sources connected to the AVR45. After pressing this button, use the **▲/▼** buttons **7** to make your selection between **OPTICAL** **E** or **COAXIAL** **G** digital. Press the **Set** button **9** to enter your choice. (See page 24 for more information.)

24 Speaker Configuration: Press this button to begin the process of configuring the AVR45's Bass Management System for use with the type of speakers used in your system. Once the button has been pressed, use the **▲/▼** buttons **7** to

select the channel you wish to set up. Press the **Set** button **9**, and then select another channel to configure. When all adjustments have been completed, press the Set button twice to exit the settings and return to normal operation. (See page 17 for more information.)

25 Surround Mode Selector: Press this button to begin the process of changing the surround mode. After the button has been pressed, use the **▲/▼** buttons **7** to select the desired surround mode. (See page 24 for more information.) Note that this button is also used to tune channels when the TV is selected using the **Device Control Selector** **2**.

When the AVR45 remote is being programmed for the codes of another device, this button is also used in the "Auto Search" process. (See page 28 for more information on programming the AVR45 remote.)

26 Volume: Press these buttons to raise or lower the system volume.

27 Sleep Button: Press this button to place the unit in the Sleep mode. After the time shown in the display, the AVR45 will automatically go into the Standby mode. Each press of the button changes the time until turn-off in the following order:

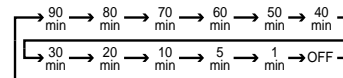

Note that this button is also used to change channels on your TV when the TV is selected using the **Device Control Selector** **2**.

When the AVR45 remote is being programmed for the codes of another device, this button is also used in the "Auto Search" process. (See page 28 for more information on programming the AVR45 remote.)

Installation and Connections

System Installation

After unpacking the unit, and placing it on a solid surface capable of supporting its weight, you will need to make the connections to your audio and video equipment. These steps need to be done only when the receiver is first installed, or when a change is made to the input source equipment.

Audio Equipment Connections

We recommend that you use high-quality interconnect cables when making connections to source equipment and recorders to preserve the quality of the signals.

When making connections to audio source equipment or speakers it is always a good practice to unplug the unit from the AC wall outlet. This prevents any possibility of accidentally sending audio or transient signals to the speakers that may damage them.

1. Connect the analog output of a CD player to the **CD** inputs ⑥.

NOTE: When the CD player has both fixed and variable audio outputs it is best to use the fixed output unless you find that the input to the receiver is so low that the sound is noisy, or high that the signal is distorted.

2. Connect the Play/Out jacks of a cassette deck, MD or other audio recorder to the **Tape Monitor In** jacks ②. Connect the Record/In jacks on the recorder to the **Tape Monitor Out** jacks ③ on the AVR45.

3. Connect the output of any digital sources to be used to the appropriate connections on the AVR45 rear panel. Note that the **Optical** and **Coaxial** digital inputs ⑬ ⑭ may be used with either a Dolby Digital (AC-3) source or the output of a conventional CD or LV player's PCM (SP/DIF) output.

4. Assemble the AM Loop Antenna supplied with the unit as shown below. Connect it to the **AM** and **GND** screw terminals ①.

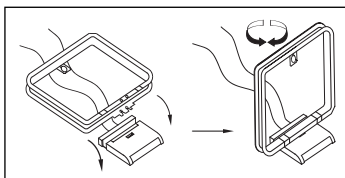

5. Connect an FM antenna to the **FM (75 ohm)** connection ②. The FM antenna may be an external roof antenna, an inside powered or wire lead antenna or a connection from a cable TV system. Note that if the antenna or connection uses 300-ohm twin-lead cable, you must use the 300-ohm-to-75-ohm adapter supplied with the unit to make the connection.

6. Connect the front, center and surround speaker outputs ⑩ ⑪ ⑫ to the respective speakers.

To assure that all the audio signals are carried to your speakers without loss of clarity or resolution, we suggest that you use high-quality speaker cable. Many brands of cable are available, and the choice of cable may be influenced by the distance between your speakers and this receiver, the type of speakers you use, personal preferences and other factors.

Your dealer or installer is a valuable resource to consult in selecting the proper cable.

Regardless of the brand of cable selected, we recommend that you use a cable constructed of fine, multistrand copper with a gauge of 14 or smaller. Remember that in specifying cable, the lower the number, the thicker the cable.

Cable with a gauge of 16 may be used for short runs of less than ten feet. We do not recommend that you use cables with an AWG equivalent of 18 or higher due to the power loss and degradation in performance that will occur.

Cables that are run inside walls should have the appropriate markings to indicate listing with UL, CSA or other appropriate testing agency standards. Questions about running cables inside walls should be referred to your installer or a licensed electrical contractor who is familiar with the NEC and/or the applicable local building codes in your area.

When connecting wires to the speakers, be certain to observe proper polarity. Remember to connect the "negative" or "black" wire to the same terminal on the receiver and the speaker. Similarly, the "positive" or "red" wire should be connected to the like terminal on the AVR45 and speaker.

We also recommend that the length of cable used to connect speaker pairs be identical. For example, use the same length piece of cable to connect the front left and front right or surround left and surround right speakers, even if the speakers are a different distance from the AVR45.

Installation and Connections

NOTE: While most speaker manufacturers adhere to an industry convention of using black terminals for negative and red ones for positive, some manufacturers may vary from this configuration. To assure proper phase, and optimal performance, consult the identification plate on your speaker, or the speaker's manual to verify polarity. If you do not know the polarity of your speaker, ask your dealer for advice before proceeding, or consult the speaker's manufacturer.

7. Connections to a subwoofer are made via a line level audio connection from the **Subwoofer Output** ⑨ to the line level input of a subwoofer with a built-in amplifier. If a passive subwoofer is used, the connection first goes to a power amplifier, which will be connected to one or more subwoofer speakers.

Video Equipment Connections

Video equipment is connected in a fashion similar to audio components. Again, the use of high-quality interconnect cables is recommended to preserve signal quality.

1. Connect a VCR's audio and video Play/Out jacks to the **Video 1 In** jacks ③ on the rear panel. The audio and Record/In jacks on the VCR should be connected to the **Video 1 Out** jacks ④ on the AVR45.
2. Connect the audio and video outputs of a satellite receiver, cable TV converter or television set or any other video source to the **Video 2 In** jacks ⑥.
3. Connect the audio and video outputs of a DVD or laser disc player to the **DVD** jacks ⑦.
4. Connect the **TV Monitor Out** ⑰ jacks on the receiver to the video input of your television monitor or video projector.

System and Power Connections

The AVR45 is designed for flexible use with external control components and power amplifiers. These connections are easy to make during an initial installation, or at a later date should you choose to upgrade your system.

Remote Control Extension

If the receiver is placed behind a solid or smoked glass cabinet door, the obstruction may prevent the remote sensor from receiving commands. In this event, an optional remote sensor may be used. Connect the output of the remote sensor to the **Remote Cont.** In jack ⑳.

If other components are also prevented from receiving remote commands, only one sensor is needed. They may use this unit's sensor or a remote eye by running a connection from the **Remote Cont.** Out jack ㉑ to the Remote In jack on Harman Kardon or other compatible equipment.

External Audio Power Amplifier Connections

If desired, optional external power audio power amplifiers may be used with the AVR45. Connections to these amplifiers are made by using audio interconnect cables connected to both the **Preamp Outputs** ⑧ on the rear panel and the audio input jacks of the external amplifiers.

External Audio Decoder Connection

To provide for the ultimate flexibility, the AVR45 may be used in conjunction with optional, external decoders for digital audio systems other than the AVR45's own built-in Dolby Digital system. If an external decoder is used, connect the output jacks of the decoder to the **6-Channel Direct** inputs ⑤, making sure to match channels.

These jacks may also be used for connections to devices such as DVD players or High Definition Television (HDTV) sets or decoders that feature built-in digital surround decoders. Although the digital decoding system in the AVR45 will typically provide audio performance that is superior to other decoders, you may use these jacks to provide an additional 6-channel input for connection to a DVD player or HDTV set with a built-in decoder and discrete 6-channel analog outputs.

AC Power Connections

This unit is equipped with two accessory AC outlets. They may be used to power accessory devices, but they should not be used with high-current draw equipment such as power amplifiers. The total power draw may not exceed 50W to each outlet.

The **Switched** ㉒ outlet will receive power only when the unit is on. This is recommended for devices that have no power switch, or a mechanical power switch that may be left in the "ON" position.

NOTE: Devices with electronic power switches may only go into a Standby mode when plugged in here.

The **Unswitched** ㉓ outlet will receive power as long as the unit is plugged into a powered AC outlet.

Finally, when all connections are complete, plug the power cord into a non-switched 120-volt AC wall outlet. You're almost ready to enjoy the AVR45!

System Configuration

When all audio, video and system connections have been made, there are a few configuration adjustments to be made. A few minutes spent to correctly configure and calibrate the unit will greatly add to your listening experience.

Speaker Selection and Placement

The placement of speakers in a multi-channel-home-theater system can have a noticeable impact on the quality of sound reproduced.

No matter which type or brand of speakers is used, the same model or brand of speaker should be used for the front left, center and right speakers. This creates a seamless front soundstage, and eliminates the possibility of distracting sonic disturbances that occur when a sound moves across mismatched front channel speakers.

Speaker Placement

Depending on the type of center channel speaker in use and your viewing device, place the center speaker directly above or below your TV or in the center behind a perforated front projection screen.

Once the center channel speaker is installed, position the left and right front speakers so that they are as far away from one another as the center channel speaker is from the preferred listening position. Ideally, the front channel speakers should be placed so that their tweeters are no more than 24" off center from the tweeter in the center channel speaker.

Depending on the specifics of your room acoustics and the type of speakers in use, you may find that imaging is improved by moving the front left and right speakers slightly forward of the center channel

speaker. If possible, adjust all front loudspeakers so that they are aimed at ear height when you are seated in the listening position.

Using these guidelines, you'll find that it takes some experimentation to find the correct location for the front speakers in your particular installation. Don't be afraid to move things around until the system sounds correct. Optimize your speakers so that pans across the front of the room sound smooth, and that sounds from all speakers appear to arrive at the listening position at the same time without delay from the center speaker as opposed to the left and right speakers.

Surround speakers should be placed on the side walls of the room, at or slightly behind the listening position. The center of the speaker should face into the room. The speakers should be located so that the bottom of the cabinet is at least two feet higher than the listeners' ears when seated in the desired area.

If side wall mounting is not practical, the speakers may be placed on a rear wall, behind the listening position. Again, they should be located so that the bottom of the cabinet is at least two feet higher than the listeners' ears. The speakers should be no more than six feet behind the rear of the seating area.

Subwoofers produce non-directional sound, so they may be placed almost anywhere in a room. Subwoofer placement is highly influenced by room size and shape, and the type of subwoofer used. Follow the instructions of the subwoofer's manufacturer, or experiment with the best location for a subwoofer in your listening room.

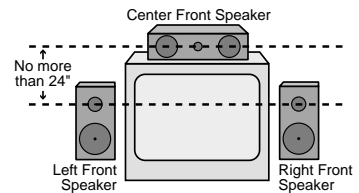

A) Front Channel Speaker Installation with Direct-View TV Sets or Rear-Screen Projectors

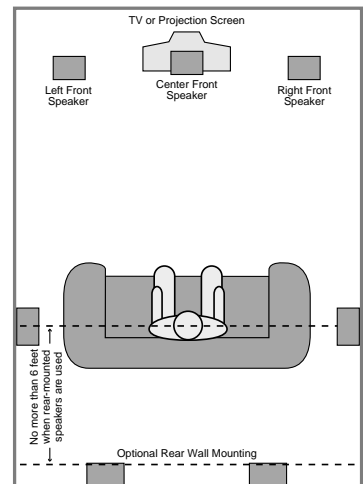

B) The distance between the left and right speakers should be equal to the distance from the seating position to the viewing screen. You may also experiment with placing the left and right speakers slightly forward of the center speaker.

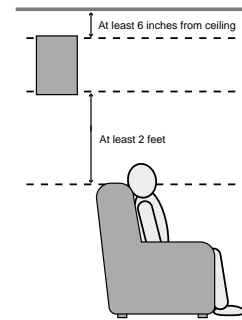

System Configuration

17

System Setup

Once the speakers have been placed in the room and connected, the final step in the setup process is to enter the settings that configure the AVR45's bass management system for the type of speakers used in your system, the calibration of the output levels and the delay times used by the surround sound processor. Before proceeding further, this is a good time to review the installation section of the manual to make certain that all connections are properly made.

You are now ready to power up the AVR45 to begin these final adjustments.

1. Plug the **Power Cable 15** to an unswitched AC outlet.
2. Press the **Main Power Switch 1** in so that it latches in with the "OFF" wording on the top of the switch inside the front panel. Note that the **Power Indicator 3** will turn amber, indicating that the unit is in the Standby mode.
3. Install the four supplied AAA batteries in the remote as shown. Be certain to observe the (+) and (-) polarity indicators shown in the bottom of the battery compartment.

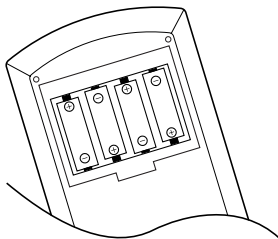

4. Turn the AVR45 on either by pressing the **System Power Control 3** on the front panel, or via the remote by first pressing the **AVR Selector 1**, and then pressing the **Power button 3**. The **Power Indicator 3** will turn green to confirm that the unit is on, and the **Information Display 33** will also light up.

Speaker Configuration

The first few adjustments tell the AVR45, which type of speakers are in use. This is important as it adjusts the settings that determine which speakers receive low-frequency (bass) information. For each of these settings use the LARGE setting if the speakers for a particular position are traditional full-range loudspeakers that are capable of reproducing sounds below 100Hz. Use the SMALL setting for smaller, frequency-limited satellite speakers that do not reproduce sounds below 100Hz. Note that when "small" speakers are used, a subwoofer is required to reproduce low-frequency sounds. Remember that the "large" and "small" descriptions do not refer to the actual physical size of the speakers, but their ability to reproduce low-frequency sounds. If you are in doubt as to which category describes your speakers, consult the specifications in the speakers' owner's manual, or ask your dealer.

With the AVR45 turned on, follow these steps to configure the speakers:

1. Put the AVR45 in the Dolby Pro Logic mode by pressing the **Dolby Pro Logic Selector 20** on the front panel or by pressing the **Surround Mode Selector 25** on the remote, followed by the **▲/▼ buttons 7** until PRO LOGIC appears in the **Main Information Display 5** and the PRO LOGIC indicator **F** lights.
2. Press the **Speaker button 24 31** on the remote or front panel. The words FRNT SPEAKER will appear in the **Main Information Display 5**.
3. Press the **Set button 9 29**.
4. Press the **▲/▼ buttons 7** on the remote or the **Selector buttons 32** on the front panel until either LARGE or SMALL appears to match the type of speakers you have at the left front and right front positions, as described by the definitions shown below.

When SMALL is selected, low-frequency sounds will be sent to the subwoofer output only. Note that if you choose this option, and there is no subwoofer connected, you will not hear any low-frequency sounds from the front channels.

System Configuration

18

When **LARGE** is selected, a full-range output will be sent to the front left and right outputs, and **NO** low-frequency signals will be sent to the subwoofer output.

- When you have completed your selection for the front channel, press the **Set** button **9 29**, and then press the **▲/▼** buttons **7** on the remote or the **Selector** buttons **32** on the front panel to change the display to **CEN SPEAKER**.
- Press the **Set** button **9 29** again, and use the **▲/▼** buttons **7** on the remote, or the **Selector** buttons **32** on the front panel, to select the option that best describes your system based on the speaker definitions shown above.

When **CEN SP SMALL** is selected, low-frequency center channel sounds will be sent to the subwoofer output only. Note that if you choose this option and there is no subwoofer connected, you will not hear any low-frequency sounds from the center channel speaker.

When **CEN SP LARGE** is selected, a full-range output will be sent to the center speaker output, and **NO** center channel signal will be sent to the subwoofer output.

When **CEN SP NONE** is selected, no signals will be sent to the center channel output. The receiver will operate in a “phantom” center channel mode and center channel information will be sent to the left and right front channel outputs.

- When you have completed your selection for the center channel, press the **Set** button **9 29**, and then press the **▲/▼** buttons **7** on the remote or the **Selector** buttons **32** on the front panel to change the display to **SUR SPEAKER**.
- Press the **Set** button **9 29** again, and then use the **▲/▼** buttons **7** on the remote or the **Selector** buttons **32** on the front panel to select the option that best describes your system based on the speaker definitions shown above.

When **SUR SP SMALL** is selected, low-frequency surround channel sounds will be sent to the subwoofer output only. Note that if you choose this option and there is no subwoofer connected, you will not hear any low-frequency sounds from the surround speaker.

When **SUR SP LARGE** is selected, a full-range output will be sent to the surround channel outputs, and **NO** surround channel signals will be sent to the subwoofer output.

When **SUR SP NONE** is selected, surround sound information will be split between the front left and front right outputs. Note that for optimal performance when no surround speakers are in use, the **Dolby 3 Stereo** mode should be used instead of **Dolby Pro Logic**.

- When you have completed your selection for the surround channel, press the **Set** button **9 29**, and then press the **▲/▼** buttons **7** on the remote or the **Selector** buttons **32** on the front panel to change the display to **S-W SPEAKER**.
- Press the **Set** button **9 29**, and then press the **▲/▼** buttons **7** on the remote or the **Selector** buttons **32** on the front panel to select the option that best describes your system.

Select **S-W SP ON** if a subwoofer is connected to your system.

Select **S-W SP OFF** if a subwoofer is NOT connected to your system. Note that when no subwoofer is selected, low-frequency sounds below 100Hz will be sent to the front left/right speakers, provided that the selection in step 4, above, has been set to **LARGE**. Otherwise, no low-frequency sounds will be heard. This option is not available when the front, center or surround speakers are set to **SMALL**.

System Configuration

19

11. When all speaker selections have been made, press the **Set** button **9** **29** to return to normal operation.

Output Level Adjustment

Output level adjustment is a key part of the configuration process for any surround sound product. It is particularly important for a Dolby Digital receiver such as the AVR45, as correct outputs will ensure that you hear sound tracks in their proper place with the proper intensity.

IMPORTANT NOTE: Many listeners are often confused about the operation of the surround channels. While some assume that sound should always be coming from each speaker, most of the time there will be little or no sound in the surround channels. This is because they are only used when a movie director or sound mixer specifically places sound there to create ambiance, an effect or to continue action from the front of the room to the rear. When the output levels are properly set it is normal for rear/surround speakers to operate only occasionally. Artificially increasing the volume to the rear speakers may destroy the illusion of an enveloping sound field that duplicates the way you hear sound in a movie theater or concert hall.

Before beginning the adjustment process make certain that all speaker connections have been properly made. The system volume should be set to the level that you will use during a typical listening session. Finally, make certain that the **Balance Control** **7** is set to the center "12 o'clock" position.

To adjust and calibrate the output levels, follow these steps. For accurate calibration, it is a good idea to make these adjustments from the location in your room that is your favorite listening position:

1. Put the AVR45 in the Dolby Pro Logic mode by pressing the **Dolby Pro Logic Selector** **20** on the front panel or by pressing the **Surround Mode Selector** **25** on the remote, followed by the **▲/▼** buttons **7** until **PRO LOGIC** appears in the **Main Information Display** **S** and the **PRO LOGIC** indicator **F** lights.
2. Press the **Test Tone** button **5** **23** on the remote or front panel. The words **T -T FL** **0dB** will appear in the **Main Information Display** **S**, and the letters **FL** will flash once each second.
3. At this point, the test noise will begin to circulate among all the speakers in a clockwise rotation.

NOTE: This is a good time to verify that the speakers have been properly connected. As the test noise circulates, listen to make certain that the sound comes from the speaker position shown in the Main Information Display. If the sound from a speaker location does NOT match the position indicated in the display, turn the AVR45 off and check the speaker wiring to make certain that each speaker is connected to the correct output terminal.

4. After checking for speaker placement, let the test noise circulate again, and listen to see which channels sound louder than the others. Using the front left (**FL** in the display) speaker as a reference, press the **▲/▼** buttons **7** on the remote or the **Selector** buttons **32** on the front panel on each channel to begin to bring them to the same level. Note that when one of the buttons is pushed, the test noise circulation will pause on the channel being adjusted to give you time to make the adjustment. When you release the button, the circulation will resume.
 5. Continue to adjust the individual speakers until they all have the same volume. Note that adjustments should be made with the **▲/▼** buttons **7** on the remote or the **Selector** buttons **32** on the front panel only, NOT the main volume controls. Then press the **Set** button **9** **29** to memorize the change. If you are using a sound pressure (SPL) meter for precise level adjustment, set the volume so that the meter reads 75dB, C-Weighting Slow.
- NOTE:** The subwoofer output level is not adjustable using the test tone. To change the subwoofer level, follow the steps for Output Level Trim Adjustment on page 27.
6. When you have adjusted the outputs so that all channels have the same level, press the **Test Tone** button **5** **23** on the remote or front panel to complete the adjustment.

System Configuration

20

Delay Settings

One aspect of the surround modes is the delay of audio signals between the front speakers and the rear speakers. Each surround mode is factory preset with a specific delay time, but it is possible to individually adjust the delay timing to custom tailor the sound to your individual taste and the acoustic conditions in your listening room or home theater.

The factory setting is appropriate for most rooms, but some installations create an uncommon distance between the front and surround speakers that may cause the arrival of front channel sounds to become disconnected from surround channel sounds.

To resynchronize the front and surround channels, follow these steps:

1. Measure the distance from the listening/viewing position to the front speakers.
2. Measure the distance from the listening/viewing position to the surround speakers.
3. Subtract the distance to the surround speakers from the distance to the front speakers.

- a. When setting the delay time for the Dolby Digital surround mode, the optimal delay time is the resulting figure. For example, if the front speakers are ten feet away and the surround speakers are five feet away, the optimal delay time is figured as $10-5=5$. Thus, in this example, the delay should be set at five milliseconds.
- b. When setting the delay time for the Pro Logic mode, take the result of the subtraction and add 15 to obtain the optimal delay time. For example, if the front speakers are ten feet away and the surround speakers are five feet away, the optimal delay time is figured as $10-5+15=20$. Thus, in this example, the delay should be set at twenty milliseconds.

The Dolby Digital mode also provides a separate setting for the center channel delay mode, since the discrete nature of Dolby Digital signals makes the location of the center channel speaker more critical. To calculate the delay for the center channel, measure the distance from the preferred listening position in the center of the room to both the center channel speaker and either the left or right speaker.

NOTE: The Theater, Hall 1 and Hall 2 modes use a fixed, non-adjustable delay time.

If the distances are equal no further adjustment is required and the center delay should be set to zero. If the distance to the front speakers is greater than the distance to the center speaker you may wish to reposition the speakers by moving the front left/right speakers closer to the listening position or the center speaker further away from the listening position.

If repositioning of the speakers is not possible, adjust the center delay time so that you add one millisecond of center channel delay for each foot that the distance to the center speaker lags behind the front speakers. For example, if the front left/right speakers are each 10 feet from the listening position and the center channel speaker is 8 feet away, the delay is figured as $10-8=2$, suggesting an optimal center delay of 2 milliseconds.

To set the delay times, follow these steps:

1. Put the AVR45 in the Dolby Pro Logic mode by pressing the **Dolby Pro Logic Selector** **20** on the front panel, or by pressing the **Surround Mode Selector** **25** on the remote, followed by the **▲/▼** buttons **7** until **PRO LOGIC** appears in the **Main Information Display** **S** and the **PRO LOGIC** indicator **F** lights.
2. Press the **Delay** button **22** **27** on the remote or front panel. The words **S DELAY TIME** will appear in the **Main Information Display** **S**.

System Configuration

21

3. Press the **Set** button **9 29**.
4. Adjust the delay time by pressing the **▲/▼** buttons **7** on the remote or the **Selector** buttons **32** on the front panel until the delay time figure calculated using the formula entered above appears in the display.
5. If no adjustment is needed for the center channel delay, press the **Set** button **9 29** to enter the setting into the AVR45's memory. If the calculations outlined above for the center channel delay require an adjustment, proceed with the following steps:
6. Select a digital input by pressing the **Digital** button **23 28**. Press the **▲/▼** buttons **7** on the remote or the **Selector** buttons **32** on the front panel until either **COAX** or **OPTICAL** appear in the **Main Information Display S**. Note that for this adjustment, either input may be selected.
7. Press the **Set** button **9 29**.
8. Select the Dolby Digital mode either by pressing the front panel **Dolby Digital Selector 19** or by pressing the **Surround Mode Selector 25** on the remote, and then pressing the **▲/▼** buttons **7** on the remote until **DOLBY AC-3** appears in the **Main Information Display S**. Ignore any "NO DATA" message that may appear.
9. Press the **Delay** button **22 27** on the remote or front panel. The words **S DELAY TIME** appears in the **Main Information Display S**.
10. Press the **▲/▼** buttons **7** on the remote once, so that **C DELAY TIME** appears in the **Main Information Display S**.
11. Press the **Set** button **9 29**.
12. Press the **▲/▼** buttons **7** on the remote until the desired delay time for the center channel appears in the display.
13. Press the **Set** button **9 29** to enter the setting into the AVR45's memory.

Congratulations! You have now completed the setup, adjustment and calibration of the AVR45. You are now ready to enjoy the finest in music and home theater listening.

Operation

22

Basic Operation

Once you have completed the setup and configuration of your new receiver, it is simple to operate and enjoy. The following instructions will provide the steps needed to enjoy the AVR45:

- When using the AVR45 for the first time, it is necessary to press the **Main Power** button **1** on the front panel to turn the unit on. This places the unit in a standby mode, as indicated by the amber color of the **Power Indicator** **3**. Once the unit is in standby, you may begin a listening session by pressing the **System Power Control** **2** on the front panel or the **Power** button **3** on the remote. Note that the **Power Indicator** **3** will turn green. This will turn the unit on and return it to the input source that was last used. The unit may also be turned on from standby by pressing any of the **Source Selector** buttons on the remote **11** or front panel **9 10 11 12 13 14**.

To turn the unit off at the end of a listening session simply press the **System Power Control** **2** on the front panel or the **Power** button **3** on the remote. Power to any equipment plugged into the rear panel **Switched AC Outlet** **14** will be shut off and the **Power Indicator** **3** will turn amber.

When the remote is used to turn the unit "off" it is actually placing the system in a standby mode, as indicated by the amber color of the **Power Indicator** **3**.

When you will be away from home for an extended period of time it is always a good idea to completely turn the

unit off using the front panel **Main Power Switch** **1**. Note that all preset memories are lost if the unit is left turned off with the **Main Power Switch** **1** for more than two weeks.

Source Selection

- To select a source at any time, press any of the **Source Selector** buttons on the remote **11** or front panel **9 10 11 12 13 14**.
- The front panel **Video 3 Inputs** **8** may be used to connect a device such as a video game or camcorder to your home entertainment system on a temporary basis.
- When an audio source is selected the last video input used remains routed to the **Video Outputs** **1 4** and **TV Monitor Output** **17**. This permits simultaneous viewing and listening to different sources.
- During a listening session you may wish to adjust the **Bass** **5** and **Treble** **6** controls to suit your listening tastes.
- Adjust the volume to a comfortable level using the front panel **Volume Control** **26** or remote **Volume Up/Down** **25** buttons.
- To temporarily silence all speaker outputs press the **Mute** button **4 25**. This will cut the output to all speakers, but it will not effect any recording or dubbing that may be in progress. When the system is muted the MUTE indicator **A** will light in the **Information Display** **23**. Press the **Mute** button **4 25** again to return to normal operation.

- For private listening, plug the 1/4" stereo phone plug from a pair of stereo headphones into the front panel **Headphone** jack **4**.

- When a Video Input source is selected the video signal for that input will be routed to the **TV Monitor Video Output** jack **17** and will be viewable on a TV monitor connected to the AVR45. Make certain that your TV is set to the proper input to view the signal.

- To program the AVR45 for automatic turn off, press the **Sleep** button **27** on the remote. Each press of the button will increase the time before shut down in the following sequence:

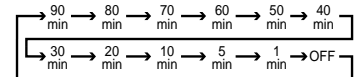

The sleep time will be displayed in the Information Display and it will count down until the time has elapsed.

When the programmed time has elapsed the unit will automatically turn off. Note that the front panel display will dim to one half brightness when the Sleep function is programmed. To cancel the Sleep function, press the **Sleep** button **27** until the information display returns to normal brightness and the Sleep indicator numbers disappear.

Surround Mode Selection

One of the most important features of the AVR45 is its ability to reproduce a full multichannel surround sound field from Dolby Digital sources, analog matrix surround encoded programs and standard stereo programs. In all a total of seven listening modes are available on the AVR45.

Operation

Selection of a surround mode is based on personal taste, as well as the type of program source material being used. For example, motion pictures or TV programs bearing the logo of one of the major surround encoding processes, such as Dolby Surround, DTS⁺ Stereo or UltraStereo^{II} may be played in either the Dolby Digital, Dolby Pro Logic or Movie Surround depending on the source material.

NOTE: Once a program has been encoded with surround information, it retains the surround matrix as long as the program is broadcast in stereo. Thus, movies with surround sound will carry surround information when they are broadcast via conventional TV stations, cable, pay TV and satellite transmission. In addition, a growing number of made-for-television programs, sports broadcasts, radio dramas and music CDs are also recorded in surround sound. You

may obtain a list of these programs and discs from the Dolby Laboratories web site at www.dolby.com

When a program is not listed as carrying intentional surround information, you may find that Pro Logic or Dolby 3-Stereo modes often deliver enveloping surround presentations through the use of the natural information present in all stereo recordings. However, for stereo, but non-surround programs, we suggest that you try the Hall 1, Hall 2 or Theater modes.

Surround Mode Chart

<i>MODE</i>	<i>FEATURES</i>	<i>DELAY TIME RANGE</i>
DOLBY DIGITAL	This mode is available only when the source material is encoded with Dolby Digital (AC-3) data. It provides up to five separate main audio channels and a special dedicated Low-Frequency Effects channel.	Center: 0 ms – 5 ms Surround: 0 ms – 15 ms
DOLBY PRO LOGIC	Dolby Pro Logic is the standard mode for analog surround sound decoding. It uses information encoded in a two-channel stereo recording to produce four distinct channels: Left, Center, Right and Surround. Use this mode for accurate reproduction of programs bearing the Dolby Surround, DTS Stereo, UltraStereo or other “Surround” logos. Surround encoded programs include videocassette, DVD and LD movies, TV and cable programs, radio programs and audio CDs. Dolby Pro Logic processing may also be used to provide a pleasing surround effect with some stereophonic source material that does not carry surround encoding.	15 ms – 30 ms Initial Setting = 20 ms
DOLBY 3 STEREO	Dolby 3 Stereo uses the information contained in a surround encoded or two-channel stereo program to create center channel information. In addition, the information that is normally sent to the rear channel surround speakers is carefully mixed in with the front left and right channels for increased realism. Use this mode when you have a center channel speaker, but no surround speakers.	No Surround Channels
THEATER	Theater Surround processing uses matrix surround decoding to simulate a standard movie or stage theater.	27.3 ms
HALL 1 and HALL 2	These modes are designed for use with stereo recordings. They provide a sound-field effect that simulates the complex combination of direct and reflected sounds that create the rich reverberant atmosphere of a medium-sized concert hall (Hall 1) or a larger concert hall (Hall 2).	Hall 1 – 41.6 ms Hall 2 – 67.4 ms
STEREO	This mode turns off all surround processing and presents the pure left and right channel presentation of two channel stereo programs.	No Surround Channels

Operation

24

Surround modes are selected using either the front panel controls or the remote. To select a surround mode from the front panel, simply press the button that corresponds to the desired mode **19** **20** **21** **22**. To select a surround mode using the remote, press the **Surround Mode Selector** **25**, and then press the **▲/▼** buttons **7** to change the mode. As you press the buttons, the surround mode name will appear in the **Main Information Display** **S**, and an individual mode indicator will also light up **D** / **F** / **J**.

Note that the Dolby Digital Mode may only be selected when a Dolby Digital source is playing. For more information on Dolby Digital, see the following section of this manual.

To listen to a program in traditional two-channel stereo, using the front left and front right speakers only (plus the sub-woofer if installed and configured), press the **Surround Off** button **24** on the front panel, or follow the instructions shown above for using the remote until **SURR OFF** appears in the **Main Information Display** **S**. When the AVR45's surround circuits are turned off, and it is in the Stereo mode, the **BYPASS** indicator **B** will illuminate in the **Information Display** **33**.

Digital Audio Playback

Dolby Digital

Dolby Digital (also known as AC-3) is the latest advancement in surround-sound technology, delivering up to five full-range surround channels (left, center, right, left surround and right surround) plus a special dedicated Low-Frequency Effects (LFE) channel. This represents a major advancement over traditional analog surround in that each surround channel is fully discrete and capable of full bandwidth reproduction. Dolby Digital is available on DVD and LV discs, and it will be a part of the new high-definition television (HDTV) system when digital broadcasting begins in 1998. Dolby Digital for the home is based on the same system used to deliver digital audio sound tracks in movie theaters, enabling true cinema reproduction in your home.

To utilize the Dolby Digital mode you must have a digital source properly connected to the AVR45. Connect the Digital datastream outputs from DVD players, HDTV receivers and CD players to the **AC-3/PCM Coaxial** or **Optical** inputs on the rear panel **18** **19**. In order to provide a backup signal and a source for recording, the analog outputs provided on digital source equipment should also be connected to their appropriate inputs on the AVR45 rear panel (e.g., connect the analog stereo audio output from a DVD to the **DVD** inputs **7** on the rear panel when you connect the digital outputs.)

When playing back a digital source, first select the input using the remote or front panel controls as outlined above. Next select the digital source by pressing the appropriate **Digital Input** button **23** **23** and then using the **▲/▼** buttons **7** on the remote or the **Selector** buttons **32** on the front panel to choose either **COAXIAL** or **OPTICAL**, as it appears in the **Main Information Display** **S**. Press the **Set** button **9** **29** to enter the desired choice. When the digital source is playing, the AVR45 will automatically detect if it is a multichannel Dolby Digital source or a conventional PCM signal, which is the standard output from CD players. An indicator will light in the Information Display to confirm the digital signal is **AC-3** **H** or **PCM** **I** and if the source is **OPTICAL** **E** or **COAX** **G**.

When an AC-3 source is playing, the AVR45 will automatically switch to the Dolby Digital surround mode. It is important to note, however, that not all AC-3 sources are encoded with the full complement of five channels plus LFE. When a digital source is playing, the **Main Information Display** **S** will change to show the input source and digital type (**OPTICAL** or **COAX**). When a source with Dolby Digital encoding is playing, the input source name will appear in the Information Display, followed by a numeric key to the type and number of channels being decoded as follows:

Operation

25

3/2-1: This message appears when a full complement of Dolby Digital signals is present: 3 front channels (left, center and right), 2 surround channels (surround left and surround right) and "1" channel, which is the dedicated Low Frequency Effects (LFE) channel.

3/1: This message indicates the AC-3 system is decoding a standard Dolby Pro Logic signal with left, center and right front channels and a signal mono surround channel.

2/0: This message indicates that the AC-3 system is decoding a traditional two-channel stereo signal and that no center, surround or LFE signals are present.

1+1: This is a monaural signal that plays the same information in both the left front and right front speakers. There is no sound sent to the center or surround speakers.

1/0: This is a monaural signal that plays through the center channel speaker only. There is no sound at the front left/right or surround speakers.

Night Mode

A special feature of Dolby Digital is the Night mode, which enables AC-3 input sources to be played back with their full range while reducing the minimum peak level by 1/4 to 1/3. This prevents abruptly loud transitions from causing disturbances without reducing the impact of the digital source. The Night mode is available only when AC-3 signals with special data are being played.

To engage the Night mode, press the **Night** button **10** on the remote and note that the **NIGHT** indicator **11** will illuminate in the Information Display.

IMPORTANT NOTES ON DOLBY DIGITAL PLAYBACK:

1. When the digital playback unit is in a pause, fast forward or chapter search mode the digital audio data may momentarily stop, causing a **NO DATA** message to be displayed. This is normal and does not indicate a problem with either the AVR45 or the source machine. The AVR45 will return to Dolby Digital/AC-3 playback as soon as the data is available when the machine is in a standard play mode.

2. The AVR45 will decode digital audio sources with a sampling frequency of 32kHz, 44.1kHz and 48kHz. Although this will enable it to decode virtually all DVD movies and HDTV sources, it is possible that some future digital sources may not be compatible with the AVR45.

NOTE: In order to play the Dolby Digital signals that are recorded on laser discs, you must have both a laser disc player with an RF output, and an optional, outboard RF-to-data demodulator. To listen to Dolby Digital LV discs, connect the AC-3/RF output of the player to the demodulator, and connect the output of the demodulator to the **Coaxial** or **Optical** inputs **18** **19** on the rear panel of the AVR45. **DO NOT** connect the AC-3/RF output of a laser disc player directly to the AVR45.

3. Note that not all programs recorded in Dolby Digital contain full 5.1 channel audio. Consult the program guide that accompanies the DVD or laser disc to determine which type of audio has been recorded on the disc. The AVR45 will automatically sense the type of digital surround encoding used on an AC-3 program source and adjust to accommodate it.

4. When a Dolby Digital source is playing, you may not select any of the analog surround modes.

5. It is not possible to record the output of a Dolby Digital program.

PCM Audio Playback

PCM (Pulse Code Modulation) is the non-compressed digital audio system used for compact discs and non-AC-3 laser discs. The digital circuits in the AVR45 are capable of high-quality digital-to-analog decoding, and they may be connected directly to the digital audio output of your CD or LV player.

Connections should be made to the **AC-3/PCM Optical** or **Coaxial** inputs **18** **19** on the rear panel, using whichever input is not occupied by an AC-3 source such as a DVD player.

To listen to a PCM digital source, first select the input for the desired source (e.g., CD). Next press the **Digital** button **23** **23** and then using the **▲/▼** buttons **7** on the remote or the **Selector** buttons **32** on the front panel until the desired choice of either **COAXIAL** or **OPTICAL**, as it appears in the **Main Information Display** **5**. Press the **Set** button **9** **29** to enter the desired choice.

Operation

26

When a PCM source is playing, the PCM indicator **P** will light, and the Main Information Display will show the input source and the digital type. During PCM playback you may select any surround mode except Dolby Digital.

Tuner Operation

The AVR45's tuner is capable of tuning AM, FM and FM Stereo broadcast stations. Stations may be tuned manually, or they may be stored as favorite station presets and recalled from a 30 position memory.

Station Selection

1. Press the **AM/FM** button **14** **11** to select the tuner as an input.
2. Press the **AM/FM** button **14** **11** again to switch between AM and FM so that the desired frequency band is selected.
3. Press the **Tune Mode** button **13** **17** to select manual or automatic tuning.

When the **AUTO** indicator **A** is illuminated in the Main Information Display the tuner will only stop at those stations that have a strong enough signal to be received with acceptable quality.

When the **MONO** indicator **M** is illuminated, the tuner is in a manual mode and will stop at each frequency increment in the selected band.

4. To select stations press the **Tuning** button **15** **20**. When the **AUTO** indicator **A** is illuminated each press will cause the tuner to search for the next highest or lowest frequency station that has an acceptable signal. When tuning FM stations in the Auto mode, the tuner will only select Stereo stations. To tune to the

next station, press the button again. If the **MONO** indicator **M** is illuminated, tap the **Tuning** button **15** **20** to advance one frequency increment at a time, or press and hold it to locate a specific station. When the **TUNED** indicator **R** illuminates, the station is properly tuned and should be heard with clarity.

5. Stations may also be tuned directly by pressing the **Direct** button **13**, and then pressing the **Numeric Keys** **12** that correspond to the station's frequency. The desired station will automatically be tuned.

NOTE: When the FM reception of a station is weak, audio quality will be increased by switching to Mono mode by pressing the **Tune Mode** button **13** **17** until the **STEREO** indicator **P** goes out.

Preset Tuning

Up to 30 stations may be stored in the AVR45's memory for easy recall using the front panel controls or the remote.

To enter a station to the memory, first tune the station using the steps outlined above. Then:

1. Press the **Memory** button **14** on the remote. Note that **MEMORY** indicator **N** will illuminate and flash in the Information Display.
2. Within five seconds, press the **Numeric Keys** **12** corresponding to the location where you wish to store this station's frequency.
3. Repeat the process after tuning any additional stations to be preset.

Recalling Preset Stations

- To manually select a station previously entered in the preset memory, press the **Numeric Keys** **12** that correspond to the desired station's memory location.
- To manually tune through the list of stored preset stations one by one, press the **Preset** buttons **17** **19** on the front panel or remote.
- To automatically scan through the stations entered in the preset memory, press the **Preset Scan** button **16** on the front panel. The tuner will run through the list of preset stations, stopping for five seconds at each one. Press the button again to stop the scan at your desired station.

Tape Recording

In normal operation, the audio or video source selected for listening through the AVR45 is sent to the record outputs. This means that any program you are watching or listening to may be recorded simply by placing machines connected to the outputs for **Tape Monitor** **23** or **Video One** **4** in the record mode.

When a tape recorder with separate record and playback heads is used, you may monitor the output of the recording by selecting the **T-Mon Selector** **9** **11**. Note that a red LED will illuminate in the front panel above the **T-Mon Selector** **9** to remind you that you are listening to the record playback instead of the actual input source being recorded.

NOTE: It is not possible to record the output of Dolby Digital programs.

Operation

27

IMPORTANT NOTE: Please make certain that you are aware of the copyright restrictions on any material you copy. Unauthorized duplication of copyrighted materials is prohibited by Federal law.

Output Level Trim Adjustment

Normal output level adjustment for the AVR45 is established using the Test Tone, as outlined on page 19. In some cases, however, it may be desirable to adjust the output levels using program material such as a test disc, or a selection you are familiar with. Additionally, the output level for the subwoofer may only be adjusted using this procedure.

To adjust the output levels using program material, first set the reference volume for the front left/right channels using the **Volume Control** **26** **26**. If you wish to vary the difference between the left and right channels, use the **Balance Control** **7**.

Once the reference level has been set, press the **Channel Select** button **8** **30** and note that **FRONT L LEV** will appear in the **Main Information Display** **S**. To change the level, first press the **Set** button **29**, and then use the **Selector** buttons **32** or the **▲/▼** buttons **7** to raise or lower the level. **DO NOT** use the volume control, as this will alter the reference setting.

Once the change has been made, press the **Set** button **29** and then press the **Selector** buttons **32** or the **▲/▼** buttons **7** to select the next output channel location that you wish to adjust. To adjust the subwoofer level, press the

Selector buttons **32** or the **▲/▼** buttons **7** until **S-SUBWOOFER LEV** appears in the **Main Information Display** **S**.

Press the **Set** button **29** when the name of the desired channel appears in the **Main Information Display** **S**, and follow the instructions shown above to adjust the level.

Repeat the procedure as needed until all channels requiring adjustment have been set. When all adjustments have been made, the AVR45 will return to normal operation when no adjustments are made for five seconds.

Six-Channel Direct Input

The AVR45 is equipped for future expansion through the use of optional, external adapters for formats that the AVR45 may not be capable of processing. When an adapter is connected to the **6-Channel Direct Inputs** **5**, you may select it by pressing the **6 CH Input Selector** **11** **13**.

Note that when the 6-Channel Direct input is in use, you may not select a surround mode, as the external decoder determines processing. In addition, there is no signal at the record outputs when the 6-Channel Direct input is in use.

Memory Backup

This product is equipped with a memory backup system that preserves tuner presets and system configuration information if the unit is accidentally unplugged

or subject to a power outage. This memory will last for approximately two weeks, after which time all information must be reentered.

Processor Reset

In the rare case where the unit's operation or the displays seem abnormal, the cause may involve the erratic operation of the system's memory or microprocessor.

To correct this problem, first unplug the unit from the AC wall outlet and wait at least three minutes. After the pause, reconnect the AC power cord and check the unit's operation. If the system still malfunctions, a system reset may clear the problem.

To clear the AVR45's entire system memory, including tuner presets, output level settings, delay times and speaker configuration data, first turn the unit off by pressing and releasing the **Master Power Switch** **1** so that it pops out from its normal recessed position. Next, press and hold the **AM/FM** **14** and the **Dolby Pro Logic** **20** buttons while pushing the **Master Power Switch** **1** in to turn the unit back on. Note that once you have cleared the memory in this manner, it is necessary to re-establish all system configuration settings and tuner presets.

If the system is still operating incorrectly, there may have been an electronic discharge or severe AC line interference that has corrupted the memory or microprocessor.

If these steps do not solve the problem, consult an authorized Harman Kardon service depot.

Programming the Remote

28

The AVR45 is equipped with a powerful remote control that will control not only the receiver's functions, but also most CD players and cassette decks manufactured by Harman Kardon. For increased flexibility, the remote also contains the codes for most popular brands of audio and video equipment, including CD players, cassette decks, TV sets, cable boxes, VCRs, satellite receivers and other home-theater equipment. Once the AVR45's remote is programmed with the codes for the products you own, it is possible to eliminate most other remotes and replace them with the convenience of a single, backlit universal remote control.

Programming the Remote

As shipped from the factory, the remote is fully programmed for all AVR45 functions, as well as those of most Harman Kardon CD changers, CD players and cassette decks. In addition, by following one of the methods below, you may program the remote to operate a wide range of devices from other manufacturers.

Direct Code Entry

This method is the easiest way to program your remote to work with different products.

1. Use the tables in the following pages to determine the three-digit code or codes that match both the product type (e.g., VCR, TV), but also the specific brand name. If there is more than one number for a brand, make note of the different choices.
2. Turn on the unit you wish to program into the AVR45 remote.

3. Press and hold both the **Device Control Selector** (2) for the type of product to be entered (e.g., VCR, TV) and the **Mute** button (4) at the same time. Hold both buttons until the red light under the button stays lit. Note that the next step must take place while the red light is on, and it must begin within 20 seconds after the light illuminates.
4. Point the AVR45's remote towards the unit to be programmed, and enter the first three-digit code number using the **Numeric** buttons (12). If the unit turns off, the correct code has been entered. Press the **Device Control Selector** (2) again, and note that the red light will flash twice to confirm the entry before going dark.
5. If the device to be programmed in does NOT turn off, continue to enter the three-digit code numbers until the equipment turns off. At this point, the correct code has been entered. Press the **Device Control Selector** (2) again, and note that the red light will flash twice to confirm the entry before going dark.
6. Try all of the functions on the remote to make certain that the product operates. Keep in mind that many manufacturers use a number of different combinations of codes, and it is a good idea to make certain that not only the Power control works, but the volume, channel and transport controls, as appropriate. If all functions do not work properly, you may need to use a different remote code.

7. If a code cannot be entered to turn the unit off, if the code for your product does not appear in the tables in this manual, or if not all functions operate properly, try programming the remote with the Auto Search Method.

Auto Search Method

If the unit you wish to include in the AVR45's remote is not listed in the code tables in this manual, or if the code does not seem to operate properly, you may wish to program the correct code using the Auto Search method as shown below.

1. Turn on the unit that you wish to include in the AVR45 remote.
2. Press the **Device Control Selector** (2) for the type of product to be entered (e.g., VCR, TV) and the **Mute** button (4) at the same time. Hold both buttons until the red light under the button stays lit. Note that the next step must take place while the red light is on, and it must begin within 20 seconds after the light illuminates.
3. Point the AVR45 remote towards the unit to be programmed, and press and hold the **Surround Mode Selector** (25) or the **Sleep** button (27). This will send out a series of codes from the remote's built-in data base, with each flash of the red light under the **Device Control Selector** indicating that a code has been sent. When the device to be programmed turns off, IMMEDIATELY release the **Surround Mode** or **Sleep** button.

Programming the Remote

29

4. Press the **Device Control Selector** again, and note that the red light will flash twice to confirm the entry before going dark.
5. Try all of the functions on the remote to make certain that the product operates. Keep in mind that many manufacturers use a number of different combinations of codes, and it is a good idea to make certain that that not only the Power control works, but the volume, channel and transport controls, as appropriate. If all functions do not work properly, you may need to Auto-Search for a different code, or enter a code via the Direct Code Entry method.

Code Readout

When the code has been entered using the Auto Search method, it is always a good idea to find out the exact code so that it may be easily reentered if necessary. You may also read the codes to verify which device has been programmed to a specific Control Selector button.

1. Press and hold both the **Device Control Selector 2** for the type of product to be entered (e.g., VCR, TV) and the **Mute button 4** at the same time. Hold both buttons until the red light under the button stays lit. Note that the next step must take place while the red light is on, and it must begin within 20 seconds after the light illuminates.

2. Press the **Night button 10**. The red light under the **Device Control Selector 2** will blink in a sequence that corresponds to the three-digit code, with a one-second pause between each digit. Count the number of blinks between each pause to determine the digit of the code. One blink is the number 1, two blinks is the number 2, and so forth. Ten blinks are used to indicate a "0".

Example: One blink, followed by a one-second pause, followed by six blinks, followed by a one-second pause, followed by ten blinks indicates that the code has been set to 160.

For future reference enter the Setup Codes for the equipment in your system here:

CD _____	TAPE _____
AUX _____	SAT _____
TV _____	VCR _____
CBL _____	

Programmed Device Functions

Once the AVR45's remote has been programmed for the codes of other devices, press the appropriate **Device Control Selector 2** to change the remote from control over the AVR45 to the additional product. When you press any of the **Device Control Selectors**, it will briefly flash in red to indicate that you have changed the device being controlled.

When operating a device other than the AVR45, the controls may not correspond exactly to the function printed on the remote or button. Some commands, such as the volume control, are the same as with the AVR45. Other buttons will change their function so that they correspond to a secondary label on the remote. For example, the Sleep and Surround Mode selector buttons also function as the Channel Up and Channel Down buttons when operating most TV sets, VCRs or cable boxes. The Channel Up/Down indication is printed directly on the remote. The same is true for standard CD player, cassette deck, VCR and DVD functions, which follow the standard function icons printed on top of the buttons.

For some products, however, the function of a particular button does not follow the command printed on the remote. In order to see which function a button controls, consult the Function List tables printed in this manual. To use those tables, first check the type of device being controlled (e.g., TV, VCR). Next, look at the remote control diagram pictured on the following page. Note that each button has a number on it.

Programming the Remote

30

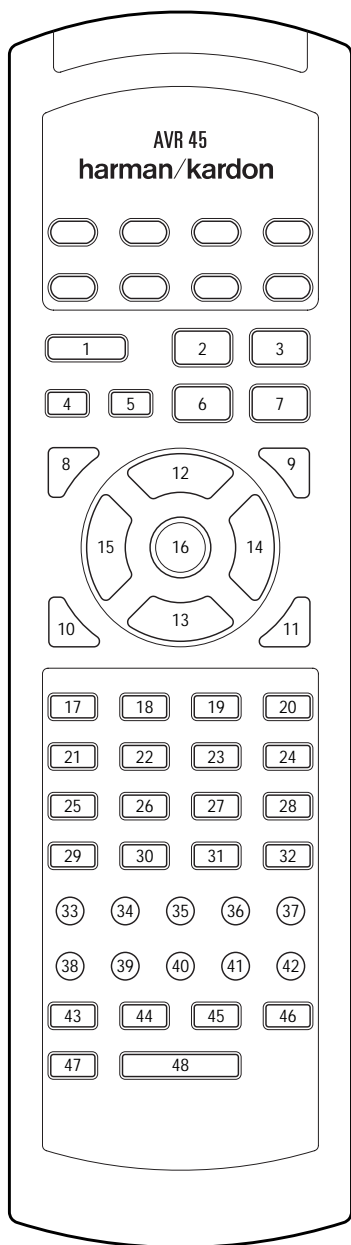

To find out what function a particular button has for a specific device, find the button number on the Function List and then look in the column for the device you are controlling. For example, button number 5 is the Test Tone button for the AVR45, but it is the “Favorite” button for many VCRs and Satellite receivers. Button number 31 is the Preset Tune Down button for the AVR45, the “Reverse Skip” button for CD players and the “Page Down” button for some cable boxes.

Notes on Using the AVR45 Remote With Other Devices.

- Manufacturers may use different code sets for the same product category. For that reason, it is important that you check to see if the code set you have entered operates as many controls as possible. If it appears that only a few functions operate, check to see if another code set will work with more buttons.
- When a button is pressed on the AVR45 remote, the red light under the **Device Control Selector** ② for the product being operated should flash briefly. If the Device Control Selector flashes for some, but not all buttons for a particular product, it does NOT indicate a problem with the remote, but rather that no function is programmed for the button being pushed.

Macro Programming

The Power button may be programmed to send out a sequence of up to eight commands when it is pushed. This enables you to turn on a number of products, and to have a program source turn to a favorite channel or any other command.

To program a macro into the Power button, follow these steps:

1. Press any of the **Device Control Selectors** ② and the **Mute** button ④ at the same time until the red light under the Device Control Selector turns on.
2. Press the **Power** button ③ and note that the Device Control Selector will blink once.
3. Enter up to eight macro steps, by pressing the **Device Control** button and then the function button for each step you wish to enter. To enter the “Power On/Off” command during macro programming, press the **Mute** button ④. DO NOT press the actual Power Button.
4. When the eight steps have been entered, press the **Sleep** button ⑳ to enter the commands. The red light under the **Device Control Selector** will blink and then turn off.

Example: To program your TV, Cable Box and the AVR45 to turn on when the Power button is pressed, first press-and-hold the **AVR** ① and **Mute** buttons ④ until the red light comes on under the **AVR** button. Next, press the **Mute** button ④ to enter the Power command for the AVR. Press the **TV Device Control Selector** ② to select the TV mode, and then press the **Mute** button ④ again, to select TV Power. Finally, press the **CBL Device Control Selector** ② followed by the **Mute** button ④ to select Cable Power. Press the **Sleep** button ⑳ to enter the commands.

Programming the Remote

31

After following these steps, each time you press the **Power** button (3), the remote will send the Power On/Off command each time the Power button is pressed.

To remove a macro program, follow steps 1, 2 and 4 above, but do not follow step three. For example, to erase the macro just entered, press the **Device Control Selector** (2) and the **Mute** button (4) at the same time until the red light under the Device Control Selector turns on. Press the **Power** button (3), and then press the **Sleep** button (27). The red light under the **Device Control Selector** will blink twice to confirm the data entry and then turn off.

Volume Punch-Through

The AVR45's remote may be programmed to operate the **Volume Control** (26) from either the TV or the AVR to operate in conjunction with any of the eight devices controlled by the remote. For example, since the AVR45 will likely be used as the sound system for TV viewing, you may wish to have the AVR's volume activated although the remote is set to run the TV. Either the AVR or TV volume control may be associated with any of the remote's devices. To program the remote for Volume Punch-Through, follow these steps:

1. Press the **Device Control Selector** (2) for the unit you wish to have associated with the volume control and the **Mute** button (4) at the same time until the red light illuminates under the **Device Control Selector**.
2. Press the **Volume Up** button (26).
3. Press either the **AVR** (1) or the **TV Device Control Selector** (2), depending on which system's volume control you wish to have attached for the punch-through mode. Note that the red light under the **Device Control Selector** will blink twice and then go out to confirm the data entry.

Example: To have the AVR's volume control be activated even though the remote is set to control the TV, first press the **TV Device Control Selector** (2), and the **Mute** button (4) at the same time. Next, press the **Volume Up** button (26), followed by the **AVR Device Control Selector** (1).

NOTE: Should you wish to return the remote to the original configuration after entering a Volume Punch-Through, you will need to repeat the steps shown above. However, press the *same* Device Control Selector in steps one and three.

Re-Assigning Device Control Selectors

Although each of the seven **Device Control Selectors** (2) is normally assigned to the category of product shown on the remote, it is possible to re-assign one of these buttons to operate a second device of another type. For example, if you have two VCRs, but no satellite receiver, you may program the "SAT" button to operate a second VCR. Before following the normal programming steps for either Three-Digit entry or Auto Search code entry, you must first re-assign the button with the following steps:

1. Press the **Device Control Selector** (2) you wish to re-assign and the **Mute** button (4) at the same time until the red light illuminates under the **Device Control Selector**.
2. Press the **Device Control Selector** (2) for the function you wish to program into the re-assigned button.
3. Enter the three-digit code for the specific model you wish the re-assigned button to operate.
4. Press the same **Device Control Selector** pressed in Step 1 again to store the selection.

Example: To use the SAT button to operate a second VCR, first press the **SAT Device Control Selector** (2), and the **Mute** button (4) at the same time until the red light glows under the SAT button. Press the VCR button, followed by the three-digit code for the specific model you wish to control. Finally, press the SAT button again.

Programming the Remote

32

Function List

No.	Button Name	CD	Tape	Aux (DVD)	TV	VCR	CBL	SAT
1	Power On/Off			Power	Power On/Off	Power On/Off	Power On/Off	Power On/Off
2	Sleep			Skip+	CH+		CH+	CH+
3	Vol UP			Vol+	Vol+	Vol+	Vol+	Vol+
4	Mute			Mute	Mute		Mute	Mute
5	Test Tone						Fav	Fav
6	Surr			Skip-	CH-		CH-	CH-
7	Vol Down			Vol-	Vol-	Vol-	Vol-	Vol-
8	Multiroom			Guide	Display		Guide	Guide
9	Speaker	Intro Scan		Menu	Menu		Menu	Menu
10	Night			Clear	Exit		Exit	Exit
11	Delay	Open/Close		Return	Prev CH		Prev CH	Prev CH
12	Level +/UP	Disk Skip +		Up	Up		Up	Up
13	Level -/Down	Disk Skip -		Down	Down		Down	Down
14	Digital			Right	Right		Right	Right
15	Channel			Left	Left		Left	Left
16	Set			Select	Select		Select	Select
17	AM/FM			Sub On/Off			Music	Alt
18	CD							
19	Rec/Pause	Pause	Record/Pause			Rec		
20	Stop	Stop	Stop	Stop		Stop		
21	Tape			Open/Close				
22	Vid 1							
23	Rev Play ◀		Rev Play					
24	Fwd Play ▶	Play	Fwd Play	Play		Play		
25	DVD							
26	Vid 2							
27	Tuning Down ◀◀	Rev Search	Rew	Search -		Rew	Day -	
28	Tuning Up ▶▶	Fwd Search	FF	Search +		FF	Day	
29	6 CH							
30	Vid 3							
31	Preset Down ◀	Rev Skip					Page -	
32	Preset Up ▶	Fwd Skip		Pause		Pause	Page +	
33	1	1			1		1	1
34	2	2			2		2	2
35	3	3			3		3	3
36	4	4			4		4	4
37	5	5			5		5	5
38	6	6			6		6	6
39	7	7			7		7	7
40	8	8			8		8	8
41	9	9			9		9	9
42	0	0			0		0	0
43	Direct	Time		Enter	Enter		Enter	Enter
44	Memory	Repeat			Sleep		PPV	
45	FM Mode	Random Play			TV/VCR	TV/VCR	Switch	TV/SAT
46	Clear	+ 10					Bypass	Next
47	Info							
48	Light			Display			Info	Info

Programming the Remote

33

Reference for Function List

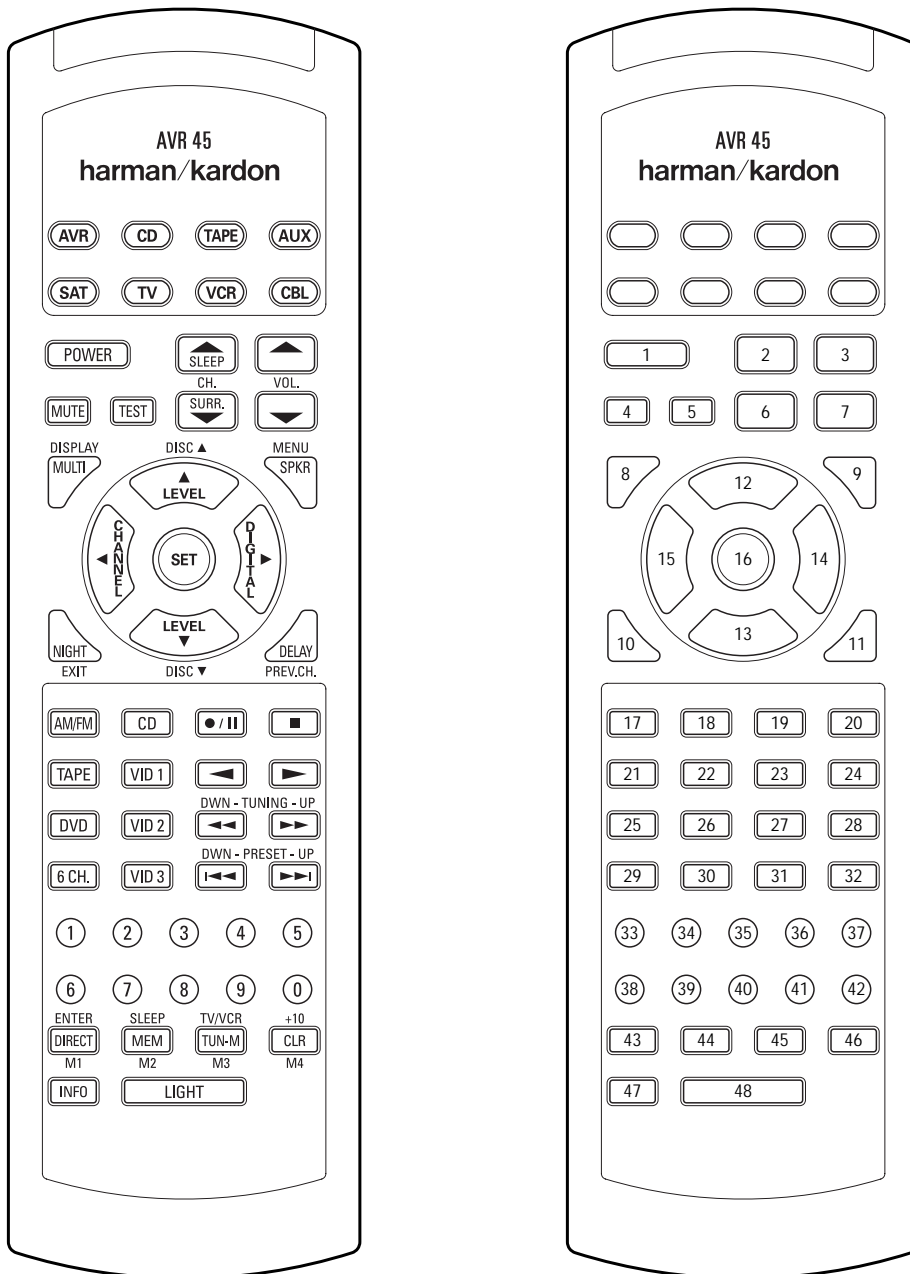

Programming the Remote

34

Setup Code Tables: TV

<i>Manufacturer/Brand</i>	<i>Setup Code Number</i>										
A MARK	112										
ADMIRAL	072	081	161								
AKAI	001	167									
AMPRO	073	167									
ANAM	043	054	055	056	080	104	108	112	118	121	
AOC	001	004	058	112							
CANDLE	001	002	003	004							
CAPEHART	058										
CENTRONIC	043										
CITIZEN	001	002	003	004	101	143					
CLASSIC	043										
CONCERTO	004										
CONTEC	043	051									
CORONADO	143										
CRAIG	054										
CROWN	143										
CURTIS MATHES	001	004	101	143							
CXC	043										
DAEWOO	004	055	103	111	114	127	143				
DAYTRON	004	143									
DWIN	177										
DYNASTY	043										
DYNATECH	062										
ELECTROHOME	024	143									
EMERSON	001	004	005	028	043	047	048	051	096	143	151 153 154 155
FISHER	007	057									
FUNAI	028	043									
FUTURETECH	043										
GE	004	008	009	034	056	073	074	091	130	144	155 160 161
GOLDSTAR	004	106	110	112	113	119	127	143			
HALL MARK	004										
HITACHI	004	007	010	011	012	023	075	143	158	163	
INFINITY	164										
INKEL	129										
JBL	164										
JCP	001										

Programming the Remote

35

Setup Code Tables: TV (Continued)

<i>Manufacturer/Brand</i>	<i>Setup Code Number</i>											
JC PENNY	004	008	024	030	065	101	143	160				
JENSEN	013											
JVC	034	038	070	083								
KENWOOD	001	070										
KLOSS	002	059										
KTV	043	143	154									
LODGENET	072											
LOGIK	072											
LUXMAN	004											
LXI	007	015	052	081	160	164						
MAGNAVOX	001	003	004	022	059	060	061	063	064	127	164	
MARANTZ	001	164										
MATSUI	164											
MEMOREX	004	007	072									
METZ	088											
MGA	001	004	024	042								
MINERVA	088											
MITSUBISHI	004	024	040	042	109	146						
MTC	001	004	062	101								
NAD	015	025										
NEC	001	019	024	040	056	130	134					
NIKEI	043											
ONKING	043											
ONWA	043											
OPTONICA	019	081										
PANASONIC	034	056	080	164								
PHILCO	001	003	004	024	056	059	060	063	064	127	143	164
PHILIPS	001	003	004	005	038	059	093	164				
PIONEER	004	018	023	025	135	176						
PORTLAND	004	143										
PROSCAN	144	160	161	167								
PROTON	004	058	143	171	173							
QUASAR	034	056										
RADIO SHACK	004	019	047	127	143							
RCA	001	004	023	024	056	065	074	144	152	156	160	161

Programming the Remote

36

Setup Code Tables: TV (Continued)

<i>Manufacturer/Brand</i>	<i>Setup Code Number</i>											
REALISTIC	007	019	047									
RUNCO	072	169										
SAMPO	001	004	058									
SAMSUNG	004	101	127	133	143	160						
SANYO	007	020	021	033	053	057	082					
SCOTT	004	028	043	048	143							
SEARS	004	007	015	028	030	057	082	094	143	160		
SHARP	004	014	019	022	028	143	175					
SIGNATURE	072											
SONY	070	085	126	139								
SOUNDESIGN	003	004	028	043								
SPECTRICON	112											
SSS	004	043										
SUPRE MACY	002											
SYLVANIA	001	003	059	060	063	064	127	160	164			
SYMPHONICS	052											
TANDY	081											
TATUNG	056	062										
TECHNICS	034	080										
TECHWOOD	004											
TENIKA	002	003	004	028	043	072	101	143				
TELERENT	072											
TERA	172											
TMK	004											
TOSHIBA	015	030	040	062	101							
TOTEVISION	143											
UNIVERSAL	008	009										
VIDEO CONCEPTS	146											
VIDIKRON	174											
VIDTECH	004											
WARDS	004	008	009	019	028	060	061	063	064	072	074	164
YAMAHA	004											
YORK	004											
YUPITERU	043											
ZENITH	072	073	095	103								
ZONDA	112											

Programming the Remote

37

Setup Code Tables: VCR

<i>Manufacturer/Brand</i>	<i>Setup Code Number</i>															
AIWA	034															
AMPRO	072															
ANAM	031	103														
AUDIO DYNAMICS	012	023	043													
BROKSONIC	035	037	129													
CANON	028	031														
CAPEHART	108															
CRAIG	001	040	135													
CURTIS MATHES	031	041														
DAEWOO	007	010	017	065	108	111										
DAYTRON	108															
DBX	012	023	043													
DYNATECH	034	053														
ELECTROHOME	059															
EMERSON	006	017	025	027	029	031	034	035	036	037	046	101	129	131	138	153
FISHER	001	008	009	010												
FUNAI	034															
GE	031	063	072	107	109	144	147									
GO VIDEO	132	136														
GOLDSTAR	004	012	020	101												
HARMAN KARDON	012	045														
HITACHI	018	026	034	043	063	137	150									
INSTANTREPLAY	031															
JCL	031															
JC PENNY	004	012	040	101												
JENSEN	043															
JVC	012	031	043	046	055	060	130	150	152							
KENWOOD	014	034	048													
LLOYD	034															
LXI	001	004	009	017	034											
MAGIN	040															
MAGNAVOX	031	034	041	067	068											
MARANTZ	012	031	067	069												
MARTA	101															
MATSUI	027	030														
MEI	031															
MEMOREX	001	010	014	031	034	040	053	072	101	134	139					
MGA	045	046	059													
MINOLTA	004	020														
MINOLTA	004	020														
MINOLTA	004	020	046	051	059	061	142									
MITSUBISHI	004	020	046	051	059	061	142									
MTC	034	040														
MULTITECH	024	034														
NEC	012	023	043	048												
MORDMENDE	043															

Programming the Remote

38

Setup Code Tables: VCR (Continued)

<i>Manufacturer/Brand</i>	<i>Setup Code Number</i>										
OPTONICA	053	054									
PANASONIC	070	133	140								
PENTAX	004	020	031	063							
PHILCO	031	034	067								
PHILIPS	031	034	054	067	101						
PILOT	101										
PIONEER	004	021	048								
PORTLAND	108										
PULSAR	072										
QUARTZ	014										
RCA	004	020	034	040	041	107	109	140	144	147	
REALISTIC	001	008	010	014	031	034	040	053	054	101	
RICO	058										
RUNCO	072										
SALORA	014										
SAMSUNG	017	040	107	109	113	115	124				
SANSUI	043	048	135								
SANYO	001	007	010	014	040	134					
SCOTT	017	037	129	131							
SEARS	001	004	008	009	010	014	017	020	081	101	
SHARP	031	054									
SHINTOM	024										
SONY	001	009	031	052	056	057	058				
SOUNDESIGN	034										
STS	004										
SYLVANIA	031	034	059	067							
SYMPHONIC	034										
TANDY	010	034									
ATATUNG	043										
TEAC	034	043									
TECHNICS	031	070									
TEKNIKA	031	034	101								
THOMAS	034										
TMK	006										
TOSHIBA	004	008	017	059	082	131					
TOTEVISION	040	101									
UNITECH	040										
VECTOR RESEARCH	012										
VICTOR	048										
VIDEO CONCEPTS	012	034	046	141							
VIDEOSONIC	040										
WARDS	001	004	017	024	031	034	040	053	054	131	
YAMAHA	012	034	043								
ZENITH	034	048	056	058	072	080	101				

Programming the Remote

39

Setup Code Tables: CD

<i>Manufacturer/Brand</i>	<i>Setup Code Number</i>							
ADCOM	062	042						
AIWA	187	170						
AKAI	202	195						
CARVER	003	167	041	135	138	139	050	203
DENON	205	226						
HARMAN KARDON	047	033	208	001	002			
JVC	022	136	163					
KENWOOD	007	055	023	137	072	142		
MARANTZ	107	044						
MONDIAL	147							
NAD	215	005						
NAKAMICHI	217	218	219					
ONKYO	038	168	030					
OPTIMUS	049	085						
PANASONIC	068							
PIONEER	010	020	174					
REALISTIC	181	187	102					
RCA	012	150						
SHARP	013	051	066	031				
SHERWOOD	166	112	115	119	093			
SONY	225	097	126	133	081			
TEAC	062	131	015	182				
TECHNICS	068	200	008	060				
YAMAHA	012	054	024					

Setup Code Tables: AUX (DVD)

<i>Manufacturer/Brand</i>	<i>Setup Code Number</i>
DENON	001
LG	010
MAGNAVOX	012
MITSUBISHI	002
PANASONIC	003
PHILIPS	012
PIONEER	004
PROSCAN	005
RCA	006
SAMSUNG	011
SONY	007
TOSHIBA	008
YAMAHA	009

Programming the Remote

40

Setup Code Tables: CABLE

<i>Manufacturer/Brand</i>	<i>Setup Code Number</i>	<i>Remote Control Model</i>
PIONEER	001	BR-200
AMERICAST	005	
JERROLD	006	RT-J22 (CFT2200)
JERROLD	007	RT-J550C
PIONEER	002	BR-95
PIONEER	003	RT-P81/82
SCIENTIFIC-ATLANTIC	004	RT-S6X/USV86
TOCOM	010	RT-T7/T8
ZENITH	008	MN2500
ZENITH	009	RT-ZPMV

Setup Code Tables: SAT

<i>Manufacturer/Brand</i>	<i>Setup Code Number</i>	
GE	001	
ALPHASTAR	007	
ECHOSTAR	006	
HITACHI	001	012
HUGHES	003	
PANASONIC	013	
PRIMESTAR	002	
PRIMESTAR	005	
RCA	001	
SONY	004	
TOSHIBA	008	
UNIDEN	009	010

Troubleshooting Guide

41

Troubleshooting Guide

<i>SYMPTOM</i>	<i>CAUSE</i>	<i>SOLUTION</i>
No front panel lights when power switch is pressed	<ul style="list-style-type: none">• No AC Power	<ul style="list-style-type: none">• Make certain AC power cord is plugged into a live outlet• Check to see if outlet is switch controlled
Display lights, but no sound or picture	<ul style="list-style-type: none">• Intermittent input connections• Mute is on• Volume control is down	<ul style="list-style-type: none">• Make certain that all input and speaker connections are secure• Press Mute button• Turn up volume control
No sound from any speaker. Light around power switch is red	<ul style="list-style-type: none">• Amplifier is in protection mode due to possible short• Amplifier is in protection mode due to internal problems	<ul style="list-style-type: none">• Check speaker-wire connections at receiver and speaker ends for shorts• Contact your local Harman Kardon service depot
No sound from surround or center speakers	<ul style="list-style-type: none">• Incorrect surround mode• Input is monaural• Incorrect configuration• Stereo or Mono program material	<ul style="list-style-type: none">• Select a mode other than Stereo• There is no surround information from mono sources• Check speaker mode• The surround decoder may not create center or rear channel information from non-encoded programs
Unit does not respond to remote commands	<ul style="list-style-type: none">• Weak batteries in remote• Wrong device selected• Remote sensor is obscured	<ul style="list-style-type: none">• Change remote batteries• Press the AVR selector• Make certain front panel sensor is visible to remote or connect remote sensor
Intermittent buzzing in tuner	<ul style="list-style-type: none">• Local interference	<ul style="list-style-type: none">• Move unit or antenna away from computers, fluorescent lights, motors or other electrical appliances

Technical Specifications

42

Audio Section

Stereo Mode

Continuous Average Power (FTC)

65 Watts per channel 20Hz–20kHz:
@ < 0.07% THD, both channels driven into 8 ohms

Five-Channel Surround Mode

Power Per Individual Channel

Front L&R channels:
55 Watts per channel,
@ < 0.07% THD, 20Hz–20kHz into 8 ohms

Center channel:
55 Watts, @ < 0.07% THD, 20Hz–20kHz into 8 ohms

Surround channels:
55 Watts per channel,
@ < 0.07% THD, 20Hz–20kHz into 8 ohms

Input Sensitivity/Impedance

Linear (High Level) 200mV/47 kohms

Signal-to-Noise Ratio (IHF-A) 95dB

Surround System Adjacent Channel Separation

Analog Decoding (Pro Logic, etc.) 40dB

Dolby Digital (AC-3) 55dB

Frequency Response

@ 1W (+0dB, –3dB) 8Hz–80kHz

High Instantaneous

Current Capability (HCC) ±35 Amps

Transient Intermodulation

Distortion (TIM) Unmeasurable

Rise Time 16 μsec

Slew Rate 40V/μsec

FM Tuner Section

Frequency Range	87.5–108MHz
Usable Sensitivity	IHF 1.3 μV/13.2dB
Signal-to-Noise Ratio	Mono/Stereo 70/68dB
Distortion	Mono/Stereo 0.3/0.5%
Stereo Separation	40dB @ 1kHz
Selectivity	±400kHz, 65dB
Image Rejection	80dB
IF Rejection	90dB
Tuner Output Level	1kHz, ±75kHz Dev 500mV

AM Tuner Section

Frequency Range	520–1710kHz
Signal-to-Noise Ratio	45dB
Usable Sensitivity	Loop 500 μV
Distortion	1kHz, 50% Mod 0.8%
Selectivity	±10kHz, 30dB

Video Section

Video Format	NTSC
Input Level/Impedance	1Vp-p/75 ohms
Output Level/Impedance	1Vp-p/75 ohms
Video Frequency Response	10Hz–8MHz (–3dB)

General

Power Requirement	AC 120V/60Hz
Power Consumption	72W idle, 332W maximum (2 channels driven)

Dimension (Max)

Width	17.3 inches (440mm)
Height	6.5 inches (165mm)
Depth	17.1 inches (435mm)
Weight	29lbs. (13.2 kg)

Depth measurement includes knobs, buttons and terminal connections.

Height measurement includes feet and chassis.

All features and specifications are subject to change without notice.

*Manufactured under license from Dolby Laboratories.
"Dolby", "Pro Logic" and the Double-D symbol are
trademarks of Dolby Laboratories. Confidential Unpublished
Works. ©1992–1997 Dolby Laboratories, Inc. All rights reserved.

†DTS is a trademark of Digital Theater Systems.

††UltraStereo is a trademark of UltraStereo Corp.

Free Manuals Download Website

<http://myh66.com>

<http://usermanuals.us>

<http://www.somanuals.com>

<http://www.4manuals.cc>

<http://www.manual-lib.com>

<http://www.404manual.com>

<http://www.luxmanual.com>

<http://aubethermostatmanual.com>

Golf course search by state

<http://golfingnear.com>

Email search by domain

<http://emailbydomain.com>

Auto manuals search

<http://auto.somanuals.com>

TV manuals search

<http://tv.somanuals.com>