



harman/kardon®

AVR 160

AUDIO/VIDEO RECEIVER

OWNER'S MANUAL

SAFETY INFORMATION

IMPORTANT SAFETY INSTRUCTIONS

1. Read these instructions.
2. Keep these instructions.
3. Heed all warnings.
4. Follow all instructions.
5. Do not use this apparatus near water.
6. Clean only with a dry cloth.
7. Do not block any ventilation openings. Install in accordance with the manufacturer's instructions.
8. Do not install near any heat sources such as radiators, heat registers, stoves or other apparatus (including amplifiers) that produce heat.
9. Do not defeat the safety purpose of the polarized or grounding-type plug. A polarized plug has two blades with one wider than the other. A grounding-type plug has two blades and a third grounding prong. The wide blade or the third prong is provided for your safety. If the provided plug does not fit into your outlet, consult an electrician for replacement of the obsolete outlet.
10. Protect the power cord from being walked on or pinched, particularly at plugs, convenience receptacles and the point where they exit from the apparatus.
11. Only use attachments/accessories specified by the manufacturer.
12. Use only with the cart, stand, tripod, bracket or table specified by the manufacturer or sold with the apparatus. When a cart is used, use caution when moving the cart/apparatus combination to avoid injury from tip-over. 
13. Unplug this apparatus during lightning storms or when unused for long periods of time.
14. Refer all servicing to qualified service personnel. Servicing is required when the apparatus has been damaged in any way, such as power supply cord or plug is damaged, liquid has been spilled or objects have fallen into the apparatus, the apparatus has been exposed to rain or moisture, does not operate normally, or has been dropped.
15. Do not expose this apparatus to dripping or splashing and ensure that no objects filled with liquids, such as vases, are placed on the apparatus.
16. To completely disconnect this apparatus from the AC Mains, disconnect the power supply cord plug from the AC receptacle.
17. The mains plug of the power supply cord shall remain readily operable.
18. Do not expose batteries to excessive heat such as sunshine, fire or the like.



The lightning flash with arrowhead symbol, within an equilateral triangle, is intended to alert the user to the presence of uninsulated "dangerous voltage" within the product's enclosure that may be of sufficient magnitude to constitute a risk of electric shock to persons.



The exclamation point within an equilateral triangle is intended to alert the user to the presence of important operating and maintenance (servicing) instructions in the literature accompanying the product.

WARNING: To reduce the risk of fire or electric shock, do not expose this apparatus to rain or moisture.

IMPORTANT SAFETY INFORMATION

Verify Line Voltage Before Use

Your AVR 160 has been designed for use with 230-240 volt AC current. Connection to a line voltage other than that for which it is intended can create a safety and fire hazard and may damage the unit.

If you have any questions about the voltage requirements for your specific model, or about the line voltage in your area, contact your selling dealer before plugging the unit into a wall outlet.

Do Not Use Extension Cords

To avoid safety hazards, use only the power cord supplied with your unit. We do not recommend that extension cords be used with this product. As with all electrical devices, do not run power cords under rugs or carpets or place heavy objects on them. Damaged power cords should be replaced immediately by an authorized service center with a cord meeting factory specifications.

Handle the AC Power Cord Gently

When disconnecting the power cord from an AC outlet, always pull the plug; never pull the cord. If you do not intend to use the unit for any considerable length of time, disconnect the plug from the AC outlet.

DECLARATION OF CONFORMITY



We, Harman Consumer Group, Inc.
2, Route de Tours
72500 Château-du-Loir,
FRANCE

declare in own responsibility, that the product described in this owner's manual is in compliance with technical standards:

EN 60065:2002; A1EN 55013:2001; A1; A2
EN 55020:2007
EN 55022:2006 (Class B)
EN 61000-3-2:2006
EN 61000-3-3:1995; A1; A2



Jurjen Amsterdam
Harman Consumer Group, Inc.
07/09



CAUTION

RISK OF ELECTRIC SHOCK
DO NOT OPEN



CAUTION: TO REDUCE THE RISK OF ELECTRIC SHOCK, DO NOT REMOVE COVER (OR BACK). NO USER-SERVICEABLE PARTS INSIDE. REFER SERVICING TO QUALIFIED SERVICE PERSONNEL.



The lightning flash with arrowhead symbol, within an equilateral triangle, is intended to alert the user to the presence of uninsulated "dangerous voltage" within the product's enclosure that may be of sufficient magnitude to constitute a risk of electric shock to persons.



The exclamation point within an equilateral triangle is intended to alert the user to the presence of important operating and maintenance (servicing) instructions in the literature accompanying the appliance.

WARNING: TO REDUCE THE RISK OF FIRE OR ELECTRIC SHOCK, DO NOT EXPOSE THIS APPLIANCE TO RAIN OR MOISTURE.

Do Not Open the Cabinet

There are no user-serviceable components inside this product. Opening the cabinet may present a shock hazard, and any modification to the product will void your warranty. If water or any metal object such as a paper clip, wire or staple accidentally falls inside the unit, disconnect it from the AC power source immediately, and consult an authorized service center.

Installation Location

- To ensure proper operation and to avoid the potential for safety hazards, place the unit on a firm and level surface. When placing the unit on a shelf, be certain that the shelf and any mounting hardware can support the weight of the product.
- Make certain that proper space is provided both above and below the unit for ventilation. If this product will be installed in a cabinet or other enclosed area, make certain that there is sufficient air movement within the cabinet. Under some circumstances, a fan may be required.
- Do not place the unit directly on a carpeted surface.
- Avoid installation in extremely hot or cold locations, or in an area that is exposed to direct sunlight or heating equipment.
- Avoid moist or humid locations.
- Do not obstruct the ventilation slots on the top of the unit, or place objects directly over them.
- Due to the weight of the AVR 160 and the heat generated by the amplifiers, there is the remote possibility that the rubber padding on the bottom of the unit's feet may leave marks on certain wood or veneer materials. Use caution when placing the unit on soft woods or other materials that may be damaged by heat or heavy objects. Some surface finishes may be particularly sensitive to absorbing such marks, due to a variety of factors beyond our control, including the nature of the finish, cleaning materials used, and normal heat and vibration caused by the use of the product, or other factors. We recommend that caution be exercised in choosing an installation location for the component and in normal maintenance practices, as your warranty will not cover this type of damage to furniture.

Cleaning

When the unit gets dirty, wipe it with a clean, soft, dry cloth. If necessary, and only after unplugging the AC power cord, wipe it with a soft cloth dampened with mild soapy water, then a fresh cloth with clean water. Wipe it dry immediately with a dry cloth. NEVER use benzene, aerosol cleaners, thinner, alcohol or any other volatile cleaning agent. Do not use abrasive cleaners, as they may damage the finish of metal parts. Avoid spraying insecticide near the unit.

Moving the Unit

Before moving the unit, be certain to disconnect any interconnection cords with other components, and make certain that you disconnect the unit from the AC outlet.

Unpacking

The carton and shipping materials used to protect your new receiver during shipment were specially designed to cushion it from shock and vibration. We suggest that you save the carton and packing materials for use in shipping if you move, or should the unit ever need repair.

To minimize the size of the carton in storage, you may wish to flatten it. This is done by carefully slitting the tape seams on the bottom and collapsing the carton. Other cardboard inserts may be stored in the same manner. Packing materials that cannot be collapsed should be saved along with the carton in a plastic bag.

If you do not wish to save the packaging materials, please note that the carton and other sections of the shipping protection are recyclable. Please respect the environment and discard those materials at a local recycling center.

It is important that you remove the protective plastic film from the front-panel lens. Leaving the film in place will affect the performance of your remote control.

TABLE OF CONTENTS

2	SAFETY INFORMATION	26	OPERATION
5	INTRODUCTION	26	Turning On the AVR
7	FRONT-PANEL CONTROLS	26	Volume Control
9	REAR-PANEL CONNECTIONS	26	Mute Function
11	MAIN REMOTE CONTROL FUNCTIONS	26	Sleep Timer
14	INTRODUCTION TO HOME THEATER	26	Tone Controls
15	CONNECTIONS	27	Headphones
15	Speaker Connections	27	Source Selection
15	Subwoofer	27	Using the Radio
15	Connecting Source Devices to the AVR	27	RDS Functions
15	Audio Connections	28	Recording
16	Digital Audio	28	Aux Input
16	Analog Audio	29	Selecting a Surround Mode
17	Video Connections	30	ADVANCED FUNCTIONS
17	Digital Video	30	Audio Processing and Surround Sound
17	Analog Video	30	Analog Audio Signals
17	Antennas	30	Digital Audio Signals
17	USB Port	30	Surround Modes
18	SPEAKER PLACEMENT	31	Dolby Surround Settings
19	GETTING STARTED	32	Manual Speaker Setup
21	INSTALLATION	34	Audio Settings
21	Step One – Connect Source Devices	35	Advanced Remote Control Functions
21	Step Two – Connect TV	36	APPENDIX
21	Step Three – Connect Loudspeakers	46	TROUBLESHOOTING GUIDE
21	Step Four – Connect FM Antenna	46	Processor Reset
21	Step Five – Connect AM Antenna	46	Memory
21	Step Six – Plug in AC Power Cords	47	TECHNICAL SPECIFICATIONS
21	Step Seven – Insert Batteries in Remote	47	Trademark Acknowledgments
22	Step Eight – Program Sources Into the Remote		
22	Step Nine – Turn On the AVR 160		
23	INITIAL SETUP		
23	Using the On-Screen Menu System		
23	Configure the AVR 160, Using EzSet/EQ™ Technology		
24	Set Up Sources		
24	6-/8-Channel Inputs		
25	System Settings		
25	Dim Function		

Please register your AVR 160 at www.harmankardon.com.

NOTE: You'll need the product's serial number. At the same time, you can choose to be notified about new products and/or special promotions.

Thank you for choosing a Harman Kardon® product!

For more than fifty years, the Harman Kardon® mission has been to share a passion for music and entertainment, using leading-edge technology to achieve premium performance. Harman Kardon, Inc., invented the receiver, a single component designed to simplify home entertainment without compromising performance. Over the years, Harman Kardon products have become easier to use, while offering more features and sounding better than ever. The AVR 160 7.1-channel digital audio/video receiver continues this tradition with some of the most advanced audio and video processing capabilities in its class, and a wealth of listening and viewing options.

To obtain the maximum enjoyment from your new receiver, please read this manual and refer back to it as you become more familiar with its features and their operation.

If you have any questions about this product, its installation or its operation, please contact your Harman Kardon retailer or custom installer, or visit the Web site at www.harmankardon.com.

Harman Kardon AVR 160 7.1-Channel Audio/Video Receiver

Audio Section

- 40 Watts x 7, seven channels driven at full power at 8 ohms, 20Hz – 20kHz, <0.07% THD, 280 watts total.
- High-current capability, ultrawide-bandwidth amplifier design with low negative feedback
- All-discrete amplifier circuitry
- Quadruple-crossover bass management
- 24-Bit, twin-core Cirrus Logic® CS 497024 DSP processor
- 192kHz/24-bit A/D and D/A conversion
- Sampling upconversion to 96kHz

Surround Modes

- Dolby Digital EX, Dolby Digital Plus, Dolby TrueHD
- Dolby Pro Logic® II and IIx (Movie, Music and Game), up to 96kHz
- Harman Virtual Speaker
- Harman Headphone
- DTS-HD High Resolution Audio™, DTS-HD Master Audio™
- DTS® (5.1; DTS Stereo; DTS-ES® 6.1 Discrete and Matrix)
- DTS 96/24™ (DTS Stereo)
- DTS Neo:6® (Cinema 5-, 6- or 7-channel; Music 5-, 6- or 7-channel), up to 96kHz
- Logic 7® (Movie, Music and Game), up to 96kHz
- 5- or 7-Channel Stereo, up to 96kHz
- Surround Off (DSP or Analog Bypass)



Audio Inputs

- AM/FM tuner
- CD
- Tape
- Front-panel Analog Audio
- 6-/8-Channel Analog Audio
- Auxiliary mini-jack

Audio/Video Inputs

- Three Analog Video
- Front-panel Analog Video
- Two Component Video 100MHz
- Three HDMI™ (V.1.3a with Deep Color)
- Transcodes component video to HDMI output, preserving native resolution
- Simultaneous output of component video sources through component video and HDMI outputs

Digital Audio Inputs

- Coaxial: two rear-panel/one front-panel
- Optical: two rear-panel/one front-panel

Outputs

- Subwoofer output
- Two Analog Audio
- One Analog Video
- Video Monitor (composite and component)
- Digital Audio (one coaxial)
- HDMI (V.1.3a with Deep Color)
- Headphone

Ease of Use

- EzSet/EQ™ automated setup (microphone supplied)
- Text-based on-screen menu system available at composite video and HDMI outputs (576i only)
- Two-line dot-matrix front-panel display
- Color-coded connections
- Programmable, 11-device remote control
- Source input renaming
- Lip Sync Delay (up to 180msec)
- System upgradeable from USB device

Supplied Accessories

The following accessory items are supplied with the AVR 160. If any of these items are missing, please contact Harman Kardon customer service at www.harmankardon.com.

- System remote control
- EzSet/EQ microphone
- AM loop antenna
- FM wire antenna
- Three AAA batteries
- Two covers for front-panel jacks

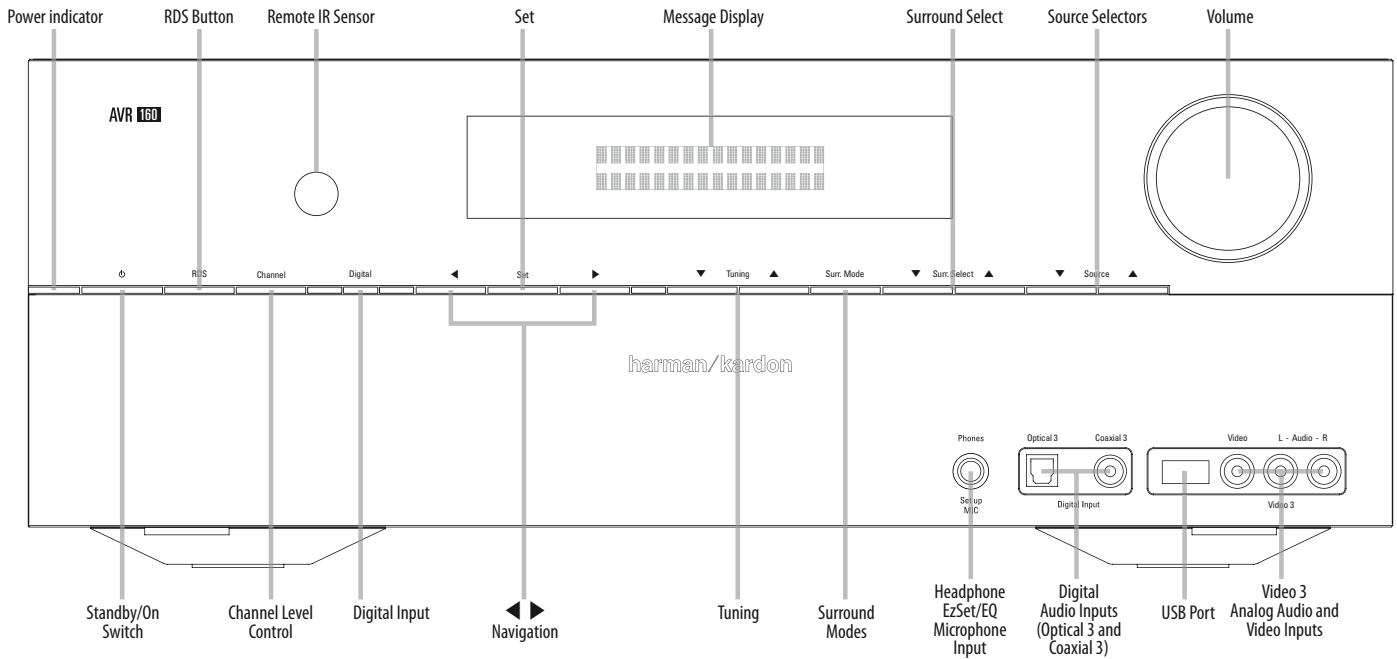

Power Indicator: This LED has three possible modes:

- **Main Power Off:** When the AVR is unplugged or the Main Power Switch is off, this LED is off.
- **Standby:** Amber indicates that the AVR is ready to be turned on.
- **On:** When the AVR is turned on, this LED turns white.

NOTE: If the PROTECT message ever appears, turn off the AVR and unplug it. Check all speaker wires for a possible short. If none is found, bring the unit to an authorized Harman Kardon service center for inspection and repair before using it again.

Standby/On Switch: This electrical switch turns the receiver on, or places it in Standby mode for quick turn-on.

RDS: Activates RDS functions for FM Radio

Channel Level Control: Press this button to adjust the output level for any amplifier channel. It may be necessary to raise or lower the level of a specific channel to compensate for the placement of the relevant speaker in the room in relation to the listening position; e.g., the center channel speaker is further away from the listening position than the front left and right speakers, so that the dialogue is too soft to hear clearly.

To adjust the level of a channel, press this button once. If the desired channel is not displayed on screen and in the front-panel Message Display, use the Tuning Buttons to scroll to it. When the desired channel appears, use the ◀ ▶ Navigation Buttons to change the level.

It is recommended that you avoid changing the channel levels after you have run the EzSet/EQ setup procedure described in the Initial Setup section, which properly adjusts all channel levels. See the Advanced Functions section for more information on manual speaker setup, including level adjustment.

Remote IR Sensor: This sensor receives infrared (IR) commands from the remote control. It is important to ensure that it is not blocked. If covering the sensor is unavoidable, use an optional Harman Kardon HE 1000, or other infrared receiver, connecting it to the Remote IR Input on the AVR 160's rear panel.

Digital Input: To change the audio input for the current source to one of the six digital audio inputs or the analog input for the source, press this button and use the ◀ ▶ Navigation Buttons to change the input. Although any digital audio input may be assigned to any source, the analog audio inputs are all permanently dedicated to the source with which they are labeled.

◀ ▶ Navigation: These buttons are used to navigate the AVR's menus.

Set: Press this button to select the currently highlighted item.

Message Display: Various messages appear in this two-line display in response to commands and changes in the incoming signal. In normal operation, the current source name appears on the upper line, while the surround mode is displayed on the lower line. When the on-screen display menu system (OSD) is in use, the current menu settings appear.

Tuning: Press these buttons to tune a radio station.

FRONT-PANEL CONTROLS

Surround Mode: Press this button to select a surround sound (e.g., multichannel) mode. Each press changes the surround mode category: AUTO SELECT, VIRTUAL, STEREO, MOVIE, MUSIC, VIDEO GAME. To change the specific mode within the category, use the Surround Select Buttons. See the Advanced Functions section for more information on surround modes.

Surround Select: After you have selected the desired surround mode category, press these buttons to select a specific mode within the category, such as to change from Dolby Pro Logic IIx Movie mode to Logic 7 Movie mode. Surround mode availability depends on the nature of the source input signal, i.e., digital versus analog, and the number of channels encoded within the signal.

Source Selectors: Press this button to select a source device, which is a component where a playback signal originates, e.g., DVD.

Headphone Jack / EzSet/EQ Microphone Input: Plug a 1/4" (6,3 mm) stereo headphone plug into this jack for private listening. This jack is also used to connect the supplied microphone for the EzSet/EQ procedure described in the Initial Setup section.

Digital Audio Inputs (Optical 3 and Coaxial 3): Connect a source component that will only be used temporarily, such as a digital camera or game console, to these jacks. Use only one type of audio. The audio input may be assigned to any video source.

USB Port: This port may be used in case a software upgrade for the receiver is offered in the future. Do not connect a storage device, peripheral product or a PC here, unless instructed to do so as part of an upgrade procedure.

Video 3 Analog Audio and Video Inputs: Connect a source component that will only be used temporarily, such as a digital camera or game console, to these jacks. These inputs are selected as the Video 3 source, and may not be assigned to other sources.

Volume Knob: Turn this knob to raise or lower the volume.

REAR-PANEL CONNECTIONS

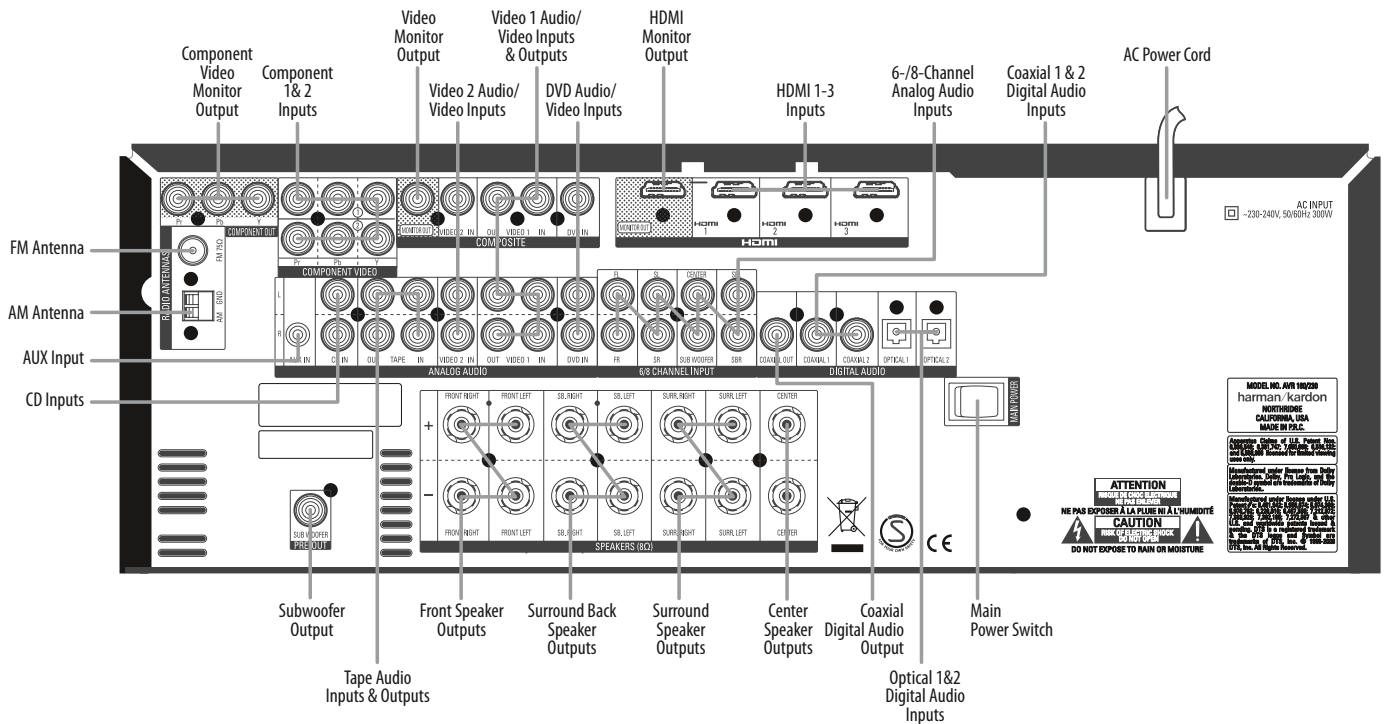

AM and FM Antenna Terminals: Connect the included AM and FM antennas to their respective terminals for radio reception.

Component Video Monitor Output: If you are using one of the Component Video Inputs and your television or video display is component-video-capable, connect these jacks to the video display.

NOTE: Due to copy-protection restrictions, there is no output at the Component Video Monitor Outputs for copy-protected sources.

Component Video 1&2 Inputs: If a video source has analog component video (Y/Pb/Pr) capability, and if you are not using an HDMI connection, connect the component video outputs of the source to one of the sets of component video inputs. Do not make any other video connections to that source.

NOTE: AVR 160 does not transcode composite video source signals to the component video format.

Video Monitor Output: If any of your sources use composite video connections, connect this monitor output to the corresponding input on your video display. Composite video source signals are only available at this output.

Video 1, Video 2 and DVD Audio/Video Inputs: These jacks may be used to connect your video-capable source components (e.g., Blu-ray Disc™ player, DVD player, cable TV box) to the receiver.

NOTE: If a source is equipped with an HDMI output, it is preferable to connect it to one of the AVR's HDMI Inputs. If the source does not have an HDMI output, use its component or composite video output, and make a separate audio connection.

Video 1 Audio/Video Outputs: These jacks may be used to connect your DVR, VCR or another recorder.

HDMI Inputs and Output: HDMI (High-Definition Multimedia Interface) is a connection for transmitting digital audio and video signals between devices. Connect up to three HDMI-equipped source devices to the HDMI inputs using a single-cable connection.

When you connect the HDMI Output to your video display, the AVR 160 will automatically transcode component video source signals to the HDMI format, but they will be passed through at the original resolution and will not be scaled. The AVR's on-screen menus are visible when the HDMI Output is used, but only at 576i resolution. The main video source will not be visible.

NOTES: When connecting a DVI-equipped display to one of the HDMI Outputs:

- Use an HDMI-to-DVI adapter.
- Make sure the display is HDCP-compliant. If it isn't, do not connect it to an HDMI Output; use an analog video connection instead.
- Always make a separate audio connection.

REAR-PANEL CONNECTIONS

AC Power Cord: After you have made all other connections, plug the AC power cord into this receptacle and into an unswitched wall outlet.

Main Power Switch: This mechanical switch turns the power supply on or off. It is usually left on, and cannot be turned on or off using the remote control.

Coaxial 1&2 and Optical 1&2 Digital Audio Inputs: If a source has a compatible digital audio output, and if you are not using an HDMI connection for audio for the device, connect it to one of these jacks to hear digital audio formats, such as Dolby Digital, DTS and linear PCM. Use only one type of digital audio connection for each source.

Coaxial Digital Audio Output: If a source is also an audio recorder, connect one of the Digital Audio Outputs to the recorder's matching input for improved recording quality. Only PCM digital audio signals are available for recording. Both coaxial and optical digital audio signals are available at either Digital Audio Output.

Front, Center Surround and Surround Back Speaker Outputs: Use two-conductor speaker wire to connect each set of terminals to the correct speaker. Remember to observe the correct polarity (positive and negative connections).

6-/8-Channel Inputs: Connect the multichannel analog audio outputs of a non-HDMI player (DVD-Audio, SACD™, Blu-ray Disc™ or HD-DVD, or any other external decoder) to these jacks. See page 25 for more information.

CD and Tape Audio Inputs: These jacks may be used to connect audio-only source components (e.g., CD player, tape deck). Do not connect a turntable to these jacks unless you are using it with a phono preamp.

Tape Outputs: These jacks may be used to connect a CDR or another audio-only recorder.

Subwoofer Output: If you have a powered subwoofer with a line-level input, connect it to the Subwoofer Output.

AUX Input: Enjoy audio from an iPod (not included), CD player or other portable player by connecting its headphone jack to this input using a 1/8" (3,5 mm) stereo mini-plug cable (not included). Video and still-image playback are not available at this input.

REMOTE CONTROL FUNCTIONS

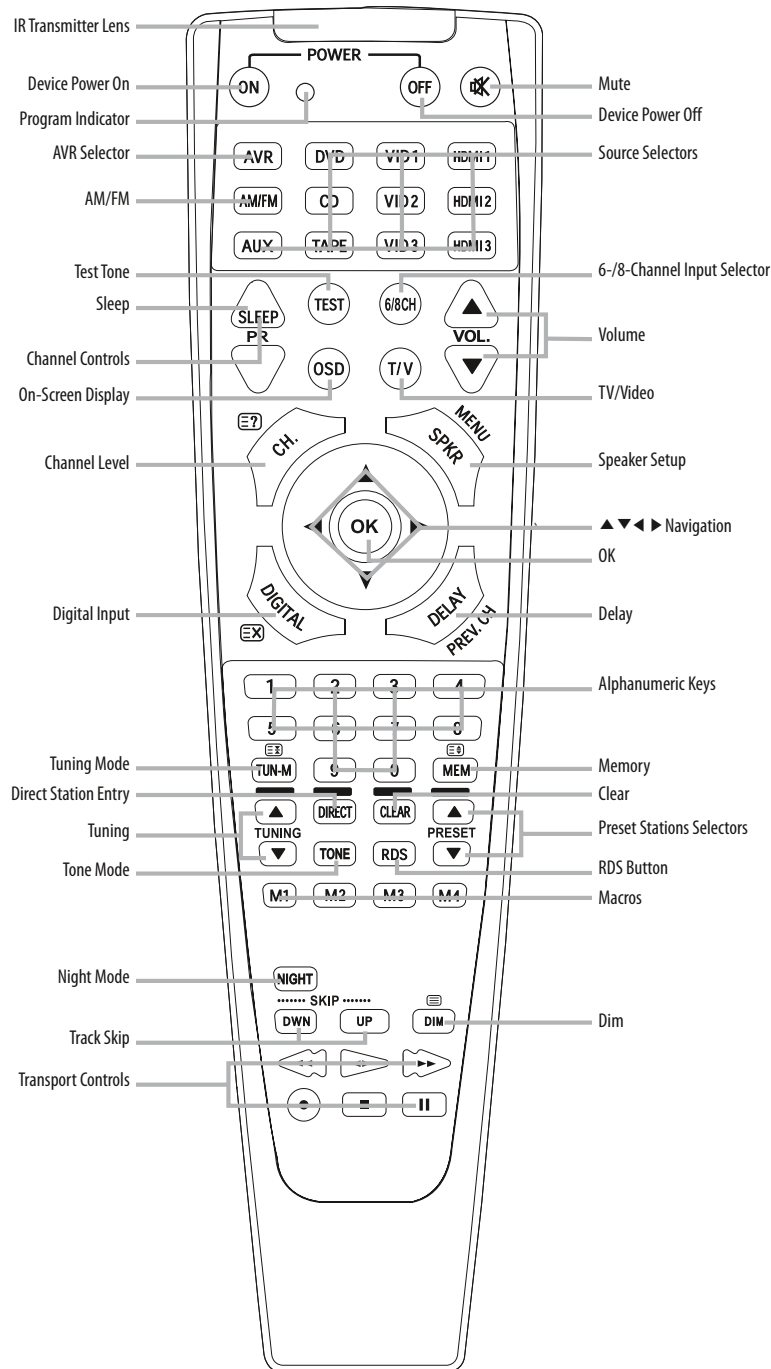

The AVR 160 remote is capable of controlling up to 11 devices, including the AVR itself and a device connected to the Auxiliary Input. During the installation process, you may program the codes for each of your source components into the remote. Each time you wish to operate any component or the AVR, first press its Selector Button to change the device mode to the appropriate codes.

Each Source Selector has been preprogrammed to control certain types of components, with only the codes specific to each brand and model changing, depending on which product code is programmed. The device types programmed into each selector, except the HDMI selectors, may not be changed.

DVD: Controls Harman Kardon Blu-ray Disc players, and many brands of DVD players and recorders.

CD: Controls CD players and recorders.

Tape: Controls cassette decks.

Video 1: Controls VCRs, TiVo® devices and DVRs, and the Harman Kardon DMC 1000 digital media center.

Video 2: Controls cable and satellite television set-top boxes.

Video 3: Controls televisions and other video displays.

HDMI 1: Controls Harman Kardon Blu-ray Disc players, and many brands of DVD players and recorders.

REMOTE CONTROL FUNCTIONS

HDMI 2 and 3: Each code set controls a source device (VCR/PVR, DVD player or cable/satellite set-top box) connected to one of these inputs.

AUX: Controls a device connected to the Auxiliary Input.

Any given button may have different functions, depending on which component is being controlled. Some buttons are labeled with these functions. For example, the Sleep Button is labeled for use as the Channel Up Button when controlling a television or cable box. See Table A10 in the appendix for listings of the different functions for each type of component.

IR Transmitter Lens: As buttons are pressed on the remote, infrared codes are emitted through this lens.

Power On Button: Press this button to turn on the AVR or another device. The Main Power Switch must first have been switched on.

Mute Button: Press to mute the AVR 160's speaker and headphone outputs. To end the muting, press this button, adjust the volume, or turn off the receiver.

Program Indicator: This LED lights up or flashes in one of three colors as the remote is programmed with codes.

Power Off Button: Press to turn off the AVR 160 or another device.

AVR Selector: Press to switch the remote to AVR device mode.

Source Selectors: Press one of these buttons to select a source device, e.g., DVD, CD, cable TV, satellite or HDTV tuner. This will also turn on the receiver and switch the remote's device mode to operate the source.

AM/FM Button: Press this button to select the tuner as the source, or to switch between the AM and FM bands.

6-/8-Channel Input Selector: Press this button to select the 6-/8-Channel Inputs as the audio source. If a signal is present at the component video inputs assigned to this source, it will be used. If not, the receiver will use the video input and remote control codes for the last-selected analog video source.

Test Tone: Press this button to activate the test tone for manual output-level calibration.

TV/Video: This button has no effect on the receiver, but is used to switch video inputs on some video source components.

Sleep Button: Press this button to activate the sleep timer, which turns off the receiver after a programmed period of time of up to 90 minutes.

Channel Controls: These buttons have no effect on the receiver, but are used to change channels on TVs and some video sources.

Volume Control: Press to raise or lower the volume, which will be shown in decibels (dB) in the Message Display.

On-Screen Display (OSD): Press this button to activate the on-screen menu system.

Channel Level: Press this button to adjust the output levels for any channel so that all speakers sound equally loud at the listening position.

Speaker Setup: Press this button to configure speaker sizes, that is, the low-frequency capability of each speaker.

Navigation (▲▼◀▶) and OK Buttons: These buttons are used to make selections within the on-screen menu system, or when accessing the functions of the four buttons surrounding this area of the remote – Channel Level, Speaker Setup, Digital Input or Delay.

Digital Input Select: Press this button to select the specific digital audio input (or analog audio input) to which the current source is connected.

Delay: Press this button to set delay times that compensate for placing the speakers at different distances from the listening position, or to resolve a "lip sync" issue that may be caused by digital video processing.

NOTE: The Channel Level, Speaker Setup, Digital Input Select and Delay functions may also be adjusted using the OSD on-screen menus. In addition, the EzSet/EQ system may be used to adjust the Channel Level, Speaker Setup and Delay settings automatically.

Numeric Keys: Use these buttons to enter radio station frequencies or to select station presets. Press the Direct Button before entering the station frequency.

Tuning Mode: This button toggles between manual (one frequency step at a time) and automatic (seeks frequencies with acceptable signal strength) tuning mode. It also toggles between stereo and mono modes when an FM station is tuned.

Memory: After you have tuned a particular radio station, press this button, then the Numeric Keys, to save that station as a radio preset.

Tuning: Press these buttons to tune a radio station. Depending on whether the tuning mode has been set to manual or automatic, each press will either change one frequency step at a time, or seek the next frequency with acceptable signal strength.

Direct: Press this button before using the Numeric Keys to directly enter a radio station frequency.

Clear: Press this button to clear a radio station frequency you have started to enter.

Preset Stations Selector: Press these buttons to select a preset radio station.

Tone Mode: Press this button to access the tone controls (bass and treble). Use the Navigation Buttons to make your selections.

RDS: Activates RDS functions for FM Radio

Macros: These buttons may be programmed to execute long command sequences with a single button press. They are useful for programming the command to turn on or off all of your components, or for accessing specialized functions for a different component than you are currently operating.

Night Mode: Press this button to activate Night mode with specially encoded Dolby Digital discs or broadcasts. Night mode compresses the audio so that louder passages are reduced in volume to avoid disturbing others, while dialogue remains intelligible.

Track Skip: These buttons have no effect on the receiver, but are used with many source components to change tracks or chapters.

Dim: Press this button to partially or fully dim the front-panel display.

Transport Controls: These buttons have no effect on the receiver, but are used to control many source components. By default, when the remote is operating the receiver, these buttons will control a Harman Kardon Blu-ray Disc player or a DVD player.

Instructions for users on removal and disposal of used batteries.

Specification of included battery types.



These symbols shown on the product, the packaging or in the manual or separate information sheet mean that the product itself, as well as the batteries included or built into the product, should never be thrown away with general household waste. Take them to suitable collection points, where proper treatment, recycling and recovery take place, in accordance with national or local legislation, or European Directives 2002/96/EC and 2006/66/EC.

Correct handling of the product and batteries to be disposed of helps to save resources and prevents possible negative effects on the environment or human health.

The batteries included with your equipment may be Alkaline, Carbon Zinc/ Manganese or Lithium (button cells) type. All types should be disposed of according to the above instructions.

To remove the batteries from your equipment or remote control, reverse the procedure described for inserting batteries in the Owners Manual.

For products with a built-in battery that lasts for the lifetime of the product, removal may not be possible for the user. In this case, recycling or recovery centers handle the dismantling of the product and the removal of the battery. If, for any reason, it becomes necessary to replace such a battery, this procedure must be performed by authorized service centers.

INTRODUCTION TO HOME THEATER

This introductory section will help you to familiarize yourself with some basic concepts unique to multichannel surround sound receivers, which will make setup and operation smoother.

Typical Home Theater System

A home theater typically includes an audio/video receiver, which controls the system; a disc player; a source component for television broadcasts (cable box, satellite dish receiver, HDTV tuner or antenna connected to the TV); a video display (television); and loudspeakers.

Multichannel Audio

The main benefit of a home theater system is the placement of loudspeakers around the room to produce "surround sound." Surround sound immerses you in the presentation for increased realism.

The AVR 160 may have up to seven speakers connected directly to it plus a subwoofer. Each main speaker is powered by its own amplifier channel inside the receiver. A system with more than two speakers is called a multichannel system.

- **Front Left and Right** – The main speakers are used as in a 2-channel system. In many surround modes, these speakers are secondary, while the main action, especially dialogue, is moved to the center speaker.
- **Center** – The center speaker is used for dialogue in movies and television programs, allowing the dialogue to originate near the actors' faces, for a more natural sound.
- **Surround Left and Right** – The surround speakers improve directionality of ambient sounds. In addition, more loudspeakers play dynamic soundtracks without risk of overloading any one speaker.
- **Surround Back Left and Right** – Additional surround speakers may be placed behind the listening position, improving the precision of ambient sounds and allowing for more realistic pans.
The surround back speakers are used with surround modes designed for 7.1-channel systems, such as Dolby Digital EX, Dolby Digital Plus, Dolby TrueHD, DTS-ES (Discrete and Matrix), DTS-HD High Resolution Audio, DTS-HD Master Audio and Logic 7 (7.1 modes). The surround back speakers are optional, and the AVR 160 may be set up with a 5.1-channel system in the main listening area.
Many people expect the surround speakers to play as loudly as the front speakers. Although all of the speakers in the system will be calibrated to sound equally loud at the listening position, most artists use the surround speakers for ambient effects only, and they program their materials to steer very little sound to these speakers.
- **Subwoofer** – A subwoofer is designed to play only the lowest frequencies (the bass). It augments smaller, limited-range satellite speakers used for the other channels. Many digital-format programs, such as movies recorded in Dolby Digital, contain a low-frequency effects (LFE) channel which is directed to the subwoofer. The LFE channel packs the punch of a rumbling train or airplane, or the power of an explosion, adding realism and excitement to your home theater. Some people use two subwoofers, for additional power and even distribution of the sound.

Surround Modes

There are different theories as to the best way to present surround sound and to distribute information to the speakers. A variety of algorithms have been developed in an effort to reproduce the way we hear sounds in the real world, resulting in a rich variety of options.

Several companies have taken surround sound in different directions:

- **Dolby Laboratories** – Dolby TrueHD, Dolby Digital Plus, Dolby Digital, Dolby Digital EX, Dolby Pro Logic II and IIx
- **DTS** – DTS-HD High Resolution Audio, DTS-HD Master Audio, DTS, DTS-ES (Discrete and Matrix), DTS Neo:6, DTS 96/24
- **Harman International (the Harman Kardon parent company)** – Logic 7, Harman Virtual Speaker, Harman Headphone
- **Stereo Modes** – Generic modes that expand upon conventional 2-channel stereo, including 5- and 7-channel stereo

Table A9 in the appendix contains detailed explanations of the mode groups and the mode options available within each group. Digital modes, such as Dolby Digital and DTS, are only available with specially encoded programs, such as HDTV, Blu-ray Disc media and digital cable or satellite television. Other modes may be used with digital and analog signals to create a different surround presentation, or to use a different number of speakers. Surround Mode selection depends upon the number of speakers in your system, the materials you are watching or listening to, and your personal tastes.

There are different types of audio and video connections used to connect the receiver, the speakers, the video display, and the source devices. The Consumer Electronics Association has established the CEA® color-coding standard. Some of these connectors are not used on the AVR 160, although they may be found on other components in your system. See Table 1.

Table 1 – Connection Color Guide



Audio Connections			
Front (FL/FR)	Left White	Right Red	
Center (C)	Green		
Surround (SL/SR)	Blue	Gray	
Surround Back (SBL/SBR)	Brown	Tan	
Subwoofer (SUB)	Purple		
Digital Audio Connections			
Coaxial	Orange		
Optical	Input 	Output 	
Video Connections			
Component	Y Green	Pb Blue	Pr Red
Composite	Yellow		
HDMI™ Connections (digital audio/video)			
HDMI			

Figure 1

Speaker Connections

Speaker cables carry an amplified signal from the receiver's speaker terminals to each loudspeaker. They contain two wire conductors, or leads, inside plastic insulation, that are differentiated in some way, such as with colors or stripes.

The differentiation preserves polarity, without which low-frequency performance can suffer. Each speaker is connected to the receiver's speaker-output terminals using two wires, one positive (+) and one negative (-). Always connect the positive terminal on the speaker, which is usually colored red, to the positive terminal on the receiver, which is colored as indicated in the Connection Color Guide above (Table 1). The negative terminals are both black.

Bare wire cables are installed as follows (see Figure 2):

1. Unscrew the terminal cap until the pass-through hole is revealed.
2. Insert the bare end of the wire into the hole.
3. Hand-tighten the cap until the wire is held snugly.

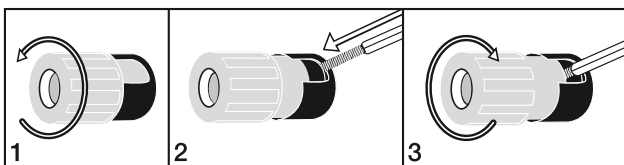

Figure 2 – Binding-Post Speaker Terminals With Bare Wires

Subwoofer

The subwoofer is dedicated to the low frequencies (bass), which require more power. To obtain the best results, most speaker manufacturers offer powered subwoofers that contain their own amplifier. Usually, a line-level (nonamplified) connection is made from the receiver's Subwoofer Output to a corresponding jack on the subwoofer, as shown in Figure 3.

Although the purple subwoofer outputs look similar to full-range analog audio jacks, they are filtered to allow only the low frequencies to pass. Don't connect these outputs to any other devices.

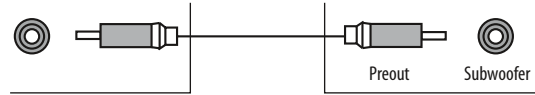

Figure 3 – Subwoofer

CONNECTING SOURCE DEVICES TO THE AVR

Audio and video signals originate in "source devices," including your Blu-ray Disc or DVD player, CD player, DVR (digital video recorder) or other recorder, tape deck, game console, cable or satellite television box, MP3 player, USB drive or network device. The AVR's tuner also counts as a source, even though no external connections are needed, other than the FM and AM antennas.

Separate connections are required for the audio and video portions of the signal, except for digital HDMI connections. The types of connections used depend upon the capabilities of the source device and video display.

Audio Connections

There are two types of audio connections: digital and analog. Digital audio signals are required for listening to sources encoded with digital surround modes, such as Dolby Digital and DTS, or for noncompressed PCM digital audio. There are three types of digital audio connections: HDMI, coaxial and optical. Do not use more than one type of digital audio connection for each source device. However, it's okay to make both analog and digital audio connections to the same source.

NOTE: HDMI signals may carry both audio and video. If your video display device has an HDMI input, make a single HDMI connection from each source device to the AVR. Usually, a separate digital audio connection is not required. Turn the volume on your television all the way down.

Digital Audio

The AVR 160 is equipped with three HDMI (High-Definition Multimedia Interface) inputs, and one output. HDMI technology enables digital audio and video information to be carried using a single cable, delivering the highest quality picture and sound.

The AVR 160 uses HDMI (V.1.3a with Deep Color) technology and is capable of processing both the audio and video components of the HDMI data, minimizing the number of cable connections in your system. The AVR 160 implements Deep Color, which increases by an order of magnitude the shades of color that can be displayed, and the latest lossless multichannel audio formats, including Dolby TrueHD and DTS-HD Master Audio.

NOTE: Some DVD-Audio, SACD, Blu-ray Disc and HD-DVD players only output multichannel audio through their multichannel analog outputs. Make a separate analog audio connection in addition to the HDMI connection, which is still used for video and to listen to Dolby Digital, DTS or PCM materials that may be stored on the disc.

The AVR 160 converts component video signals to the HDMI format, including its on-screen menus, but outputs them at their native resolution.

The HDMI connector is shaped for easy plug-in (see Figure 4). If your video display has a DVI input and is HDCP-compliant, use an HDMI-to-DVI adapter (not included). A separate audio connection is required. HDMI cable runs are limited to about 3 meter.



Figure 4 – HDMI Connection

If your video display or source device is not HDMI-capable, use one of the analog video connections (composite or component video) and a separate audio connection.

Coaxial digital audio jacks are usually color-coded in orange. Although they look similar to analog jacks, you should not connect coaxial digital audio outputs to analog inputs or vice versa. See Figure 5.

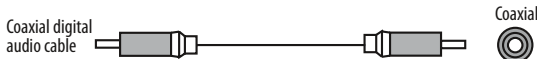

Figure 5 – Coaxial Digital Audio

Optical digital audio connectors are normally covered by a shutter to protect them from dust. The shutter opens as the cable is inserted. Input connectors are color-coded using a black shutter, while outputs use a gray shutter. See Figure 6.

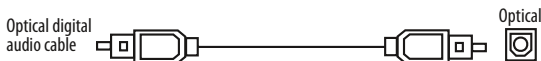

Figure 6 – Optical Digital Audio

Analog Audio

Analog connections require two cables, one for the left channel (white) and one for the right channel (red). These two cables are often attached to each other. See Figure 7.

For sources that are capable of both digital and analog audio, you may make both connections.

You may only record materials from DVDs or other copy-protected sources using analog connections. Remember to comply with all copyright laws, if you choose to make a copy for your own personal use.

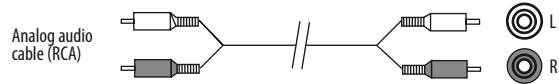

Figure 7 – Analog Audio

The 6-/8-Channel Inputs are multichannel analog connections that are used with high-definition sources that decode the copy-protected digital content, such as some DVD-Audio, SACD, Blu-ray Disc and HD-DVD players. See Figure 8. The multichannel analog audio connection is not required for players compliant with HDMI version 1.1 or better, or that output linear PCM signals via an HDMI connection. Consult the owner's guide for your disc player for more information, and see page 25.

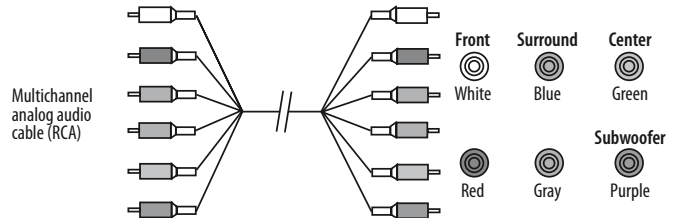

Figure 8 – Multichannel Analog Audio

The AVR 160 has an Auxiliary Audio Input on the rear panel in the form of a stereo 1/8" (3,5 mm) mini jack. Connect the headphone output of any audio source, such as an MP3 player or portable CD player, to the Auxiliary Audio Input. See Figure 9.



Figure 9 – Auxiliary Audio Input

Video Connections

Many sources output both audio and video signals (e.g., Blu-ray Disc or DVD player, cable television box, HDTV tuner, satellite box, VCR, DVR). In addition to the audio connection, make one type of video connection for each of these sources (only one at a time for any source).

Digital Video

If you have already connected a source device to one of the HDMI inputs, you have automatically made a video connection, as the HDMI signal includes both digital audio and video components.

Analog Video

There are two types of analog video connections: composite video and component video.

Composite video is the basic connection most commonly available. The jack is usually color-coded yellow, and looks like an analog audio jack. Do not plug a composite video cable into an analog or coaxial digital audio jack, or vice versa. Both the chrominance (color) and luminance (intensity) components of the video signal are transmitted using a single cable. See Figure 10.

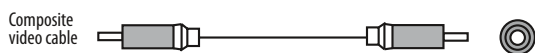

Figure 10 – Composite Video

Component video separates the video signal into three components – one luminance (“Y”) and two sub-sampled color signals (“Pb” and “Pr”) – that are transmitted using three separate cables. See Figure 11.

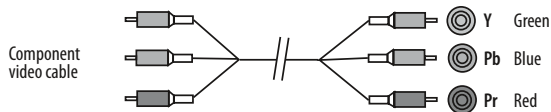

Figure 11 – Component Video

If it's available on your video display, an HDMI connection is recommended as the best quality connection, followed by component video and then composite video.

NOTE: HDCP-copy-protected sources are not available at the Component Video Monitor Outputs.

ANTENNAS

The AVR 160 uses separate terminals for the included FM and AM antennas.

The FM antenna uses a 75-ohm F-connector. See Figure 12.

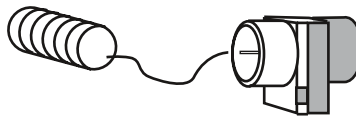

Figure 12 – FM Antenna

The AM loop antenna needs to be assembled. Connect the two leads to the spring terminals on the receiver. The AM antenna leads have no polarity, and you may connect them to either terminal. See Figure 13.

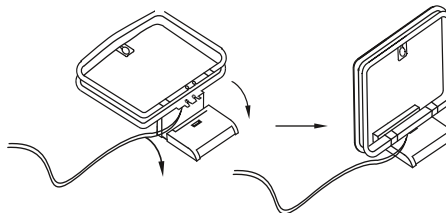

Figure 13 – AM Antenna

USB PORT

The USB Port on the AVR 160 is used only for software upgrades. If an upgrade for the receiver's operating system is released in the future, it may be downloaded to the AVR using this port. Complete instructions will be provided at that time.

SPEAKER PLACEMENT

Optimally, the speakers should be placed in a circle with the listening position at its center. The speakers should be angled so that they directly face the listening position.

Front Speaker Placement

The center speaker is placed either on top of, below or mounted on the wall above or below the video display screen.

The front left and right speakers are placed along the circle, about 30 degrees from the center speaker and angled toward the listener.

Place the front left/right and center speakers at the same height, preferably at about the same height as the listener's ears. The center speaker should be no more than approx. 60 cm above or below the left/right speakers. If you're using only two speakers with the AVR 160, place them in the front left and right positions.

Placement of the surround speakers depends on the number of speakers in your system.

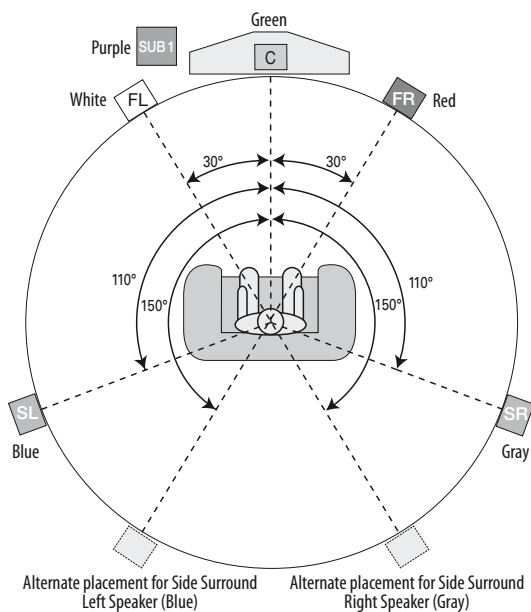

Figure 14 – Speaker Placement (5.1- Channel System)

Placement of Surround Speakers in a 5.1- Channel System

The side surround speakers should be placed 110 degrees from the center speaker, slightly behind and angled toward the listener. Alternatively, place them behind the listener, with each surround speaker facing the opposite-side front speaker. See Figure 14. The surround speakers may be placed a little higher than the listener's ears.

Placement of Surround Speakers in a 7.1- Channel System

In a 7.1- channel system, the side surround speakers are placed 90 degrees from the center speaker, directly to either side of the listening position. The surround back left and right speakers are placed 150 degrees from the center speaker, or directly facing the opposite-side front speaker. See Figure 15.

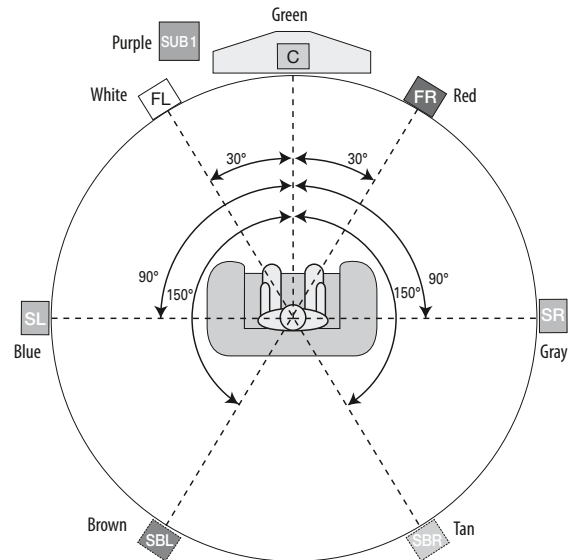

Figure 15 – Speaker Placement (7.1- Channel System)

NOTE: Some speaker manufacturers offer 6.1-channel speaker systems, for 6.1-channel surround sound formats, such as Dolby Digital EX, DTS-ES Discrete and Matrix modes and DTS Neo:6 mode. Using the AVR 160 in a 6.1-channel configuration is not recommended. The 6.1-channel formats will sound better when played through a 7.1-channel system. The same surround back channel information is played through both surround back speakers, but with twice the power and clarity.

To use the AVR 160 with a 6.1-channel speaker system, place the single surround back speaker directly behind the listener, but do not connect it until after you have run the EzSet/EQ procedure for a 5.1-channel system. After the EzSet/EQ process finishes, connect the surround back speaker to the Surround Back Left Speaker Output. Then follow the directions in the Advanced Features section for manual setup of the surround back speaker.

Subwoofer Placement

Placement of the subwoofers is less critical, since low-frequency sounds are omnidirectional. Placing each subwoofer close to a wall or in a corner will reinforce the low frequencies, and may create a "boomy" sound. Temporarily place one subwoofer where the listener normally sits, then walk around the room until the low frequencies sound best. Place the subwoofer in that spot.

NOTE: Your receiver will sound its best when the same model or brand loudspeaker is used for all positions.

Installing the AVR 160 and connecting it to the other system components can be complex. To simplify installation, it is suggested that you design your system before you begin connecting wires and cables.

Although the rear-panel jacks allow for a variety of audio and video connections to other components, the AVR's software organizes the connections into 6 conventional sources: DVD (Blu-ray Disc player or DVD player), CD, Tape (audio recorder), Video 1 (VCR), Video 2 (Cable/Sat) and Video 3 (TV). Each of these sources uses dedicated analog audio inputs, and the DVD and Video 1/2/3 sources also use dedicated composite video inputs.

The AVR 160 also features six digital audio inputs (two each coaxial and optical on the rear panel, and one of each type on the front panel). The digital audio inputs, which offer improved performance when available on the source device, may be assigned to any source, as explained in the Initial Setup section.

The two component video inputs offer improved video performance when available on the source device and video display, and may also be assigned to any source.

The 6-/8-Channel Analog Audio Inputs are selected as a separate source, but may only be used with one of the two component video inputs.

For superior audio and video performance, the AVR 160 is equipped with three dedicated HDMI inputs, which may be used with any type of source device that has an HDMI output. The HDMI inputs may be used with an analog or digital audio input or one of the component video inputs. This flexibility facilitates using the AVR with sources that do not output multichannel audio through their HDMI outputs.

Table A1 in the appendix indicates the default device types for each source, and the default audio/video connection assignments. If the defaults suit your system, then connect your devices to the audio/video inputs shown. Otherwise, design your system as explained below.

- 1. Best video connection type for your system:** Examine the video inputs on your TV or video display. Write down the best available video connection type here: _____.
The options, in order of preference, are: HDMI, DVI (must be HDCP-compliant), component video or composite video. This is the "system-best" video connection for your system.

- 2. Decide which source will be used for each device:** Match up to 6 devices to the 6 conventional sources listed in the Table 2 worksheet below. Any source device with compatible output connectors may be connected to any source inputs on the AVR. Matching the source devices to the named sources simplifies setup and programming the remote control. It is recommended that you match source devices as follows:

- **DVD:** DVD, VCR/PVR/DMC, Cable/Satellite
- **VIDEO 1:** VCR, PVR (such as TiVo), DVD recorder
- **VIDEO 2:** Cable or satellite set-top box
- **VIDEO 3:** TV (video display) or HDTV set-top box
- **CD:** CD player
- **TAPE:** Cassette deck or audio recorder (remote may only operate Harman Kardon cassette decks)
- **HDMI 1:** Blu-ray Disc player or DVD player (remote may only operate Harman Kardon Blu-ray Disc players, or many brands of DVD players)
- **HDMI 2 or 3:** Any device equipped with an HDMI output; the device type is selected from one of the other options while programming the remote
- **AUX:** Portable audio player (remote is not programmable to operate this device)

- 3. Best video connection for each source:** Examine each source device and write down the best available type of video connection, but not better than the system-best connection. Leave blank audio-only sources, such as a CD player.

- 4. Best audio connection for each source:** For each source device, write down the best available type of audio connection. See the note below, and if the HDMI connection may be used for audio, it is the best option. The other options, in order of preference, are: optical digital audio, coaxial digital audio, 2-channel analog audio. If you select an HDMI input, that becomes the AVR source for the device. If you select a 2-channel analog audio input, that input becomes the AVR source. The digital audio inputs will be assigned to a source during Initial Setup.

Table 2 – Source Assignment Worksheet

Source	Device Type	Best Video Connection (HDMI, DVI, Component, Composite)	Video Input Assigned	Best Audio Connection (HDMI, Optical, Coaxial, 2-Ch Analog)	Audio Input Assigned (may be one digital plus one or more analog)	Analog Audio Input for Recording
Video 1	VCR					
Video 2	Cable or Sat					
Video 3	TV					
DVD	DVD					
CD	CD					
Tape	Cassette deck					
AUX	Portable player					
HDMI 1	Blu-ray Disc or DVD					
HDMI 2						
HDMI 3						
6-/8-CH						

NOTES:

- For multichannel disc players, if both the device and the TV use HDMI connections for video, then check the owner's manual for the device to determine whether it transmits multichannel audio via its HDMI output. If it does, then no separate audio connection is required. If not, write down the multichannel analog audio connection in addition to any other audio type. An analog video connection, in addition to the HDMI connection, will be required. See page 25 for more information.
- If the device uses an HDCP-compliant DVI output for video, then connect it to one of the AVR's HDMI Inputs using an HDMI-to-DVI adapter, but a separate audio connection will always be required.
- The AUX Input jack on the rear panel requires a 1/8" (3,5 mm) stereo audio mini-plug. Purchase a stereo audio cable with 1/8" (3,5 mm) mini-plugs at both ends. Connect one end to the 1/8" (3,5 mm) headphone jack found on many portable audio players, and plug the other end of the cable into the AUX Input jack. The AUX Input may also be used with audio devices that have conventional left and right analog audio output jacks. Purchase a cable that has left and right "RCA-style" plugs at one end and a 1/8" (3,5 mm) mini-plug at the other end to connect the player to the AUX Input.

5. Decide which sources to connect to each of the video

inputs: Assign only one unique video input to each source. Use the best type of video connection available for each source.

- If your system-best video connection is "HDMI", select up to four HDMI source devices and assign them to one of the three numbered HDMI sources.
- If your system-best video connection is "Component", or if you have source devices with component video outputs that weren't assigned to one of the HDMI Inputs, assign up to three devices to one of the three numbered Component Video Inputs.
- If your system-best video connection is "Composite Video", or if you have source devices with composite video outputs that have not been assigned to any other video input, then assign the devices to one of the four conventional sources (DVD, Video 1, 2 or 3). The composite video inputs are dedicated to each source and may not be reassigned. Use the composite video input for the source you assigned to the device in number 2 above.

NOTE: If the source device is a video recorder that will be used to record from other devices connected to the AVR, assign the recorder to the Video 1 Input, which has a recording output. Any of the Coaxial or Optical Digital Inputs may be assigned to the recorder for audio, if it is capable of making digital audio recordings. To make audio-only recordings, assign the Tape source to the recorder. It is not necessary to connect TiVo or Video Recorder devices that will only record from their direct cable or satellite television signals to the AVR's recording outputs.

6. Decide which audio inputs to connect to each source:

Assign only one unique digital audio input to each digital source. Analog audio inputs are used for analog sources, or as secondary connections for digital sources for backup or for recording. The 2-channel analog audio inputs are dedicated to the four conventional sources (DVD, Video 1, 2 or 3) and may not be reassigned. Use the 2-channel analog audio input for the source you assigned to the device in number 2 above.

- Any source using an HDMI Input requires no additional connection for audio *unless*:
 - ◆ The source doesn't output multichannel audio through its HDMI output. Make a second connection to the 6-/8-Channel Analog Audio Inputs.
 - ◆ The source has an HDCP-compliant DVI output for video only. Assign a digital or analog audio input.
- For any source whose best audio connection is optical or coaxial digital audio, assign one of the three Optical or three Coaxial Digital Audio Inputs. Do not connect both types of digital audio to the same source device.
- You may assign one of the 2-Channel Analog Audio Inputs to a digital source.
- You may also assign the 6-/8-Channel Analog Audio Inputs, if available, to a digital source. See page 25.
- Use the 2-channel Analog Audio Input for the source selected for the device in number 2 above when the device is an analog source.

NOTE: If the source device is a digital audio recorder, it may be used with any of the Coaxial or Optical Digital Audio Inputs and the Coaxial Digital Audio Output. Both coaxial and optical signals are available at either digital audio output. To make analog recordings, assign either the Analog 2 or 4 Audio Inputs to the recorder, as both have recording outputs.

You are now ready to begin installing the AVR. Before beginning to connect the various components to the receiver, turn off all devices, including the AVR 160, and unplug their power cords. *Don't plug in any of the power cords until you have finished making all of your connections.*

The receiver generates heat. Select a location that leaves several centimeters of space on all sides. Avoid completely enclosing the receiver inside an unventilated cabinet. Place components on separate shelves rather than stacking them directly on top of the receiver. *Never block the AVR's ventilation slots on the top and side panels. Doing so could cause the AVR to overheat, with potentially serious consequences. Some shelf surface finishes are delicate. Try to select a location with a sturdy surface finish.*

Almost all of the following installation steps are optional, depending on your system. Skip any step that does not apply to your system.

STEP ONE – Connect Source Devices

Leaving all AC power cords unplugged, connect the source devices to the AVR using the audio and video inputs you assigned in Table 2.

STEP TWO – Connect TV

Connect the system-best video input on the TV to the corresponding video monitor output on the AVR.

If your video display or source device is not HDMI-capable, you will need to use one of the analog video connections (composite or component video).

STEP THREE – Connect Loudspeakers

After you have placed your loudspeakers in the room as explained on page 18, connect each speaker to its color-coded terminal on the AVR. Maintain proper polarity by connecting the negative terminal on the speaker (usually colored black) to the negative terminal on the AVR (also colored black); and the positive terminal on the speaker (usually red) to the positive terminal on the AVR (color varies by channel; see Table 1 on page 15).

If you have a subwoofer, connect its line-level or LFE input to the purple Subwoofer Output.

NOTE: If the subwoofer only has speaker-level inputs, after you have configured the AVR using EzSet/EQ technology as described on page 23, connect the subwoofer's left and right speaker input terminals to the AVR's Front Left and Front Right Speaker Outputs, then connect the front left and right main speakers to the subwoofer's left and right speaker output terminals. Consult the owner's manual for the subwoofer for specific installation instructions.

STEP FOUR – Connect FM Antenna

Connect the included FM antenna to the 75-ohm FM antenna terminal.

STEP FIVE – Connect AM Antenna

Assemble the included AM antenna (see Figure 16) and connect it to the AM and Ground antenna terminals. The antenna is not polarized, and either lead may be connected to either terminal.

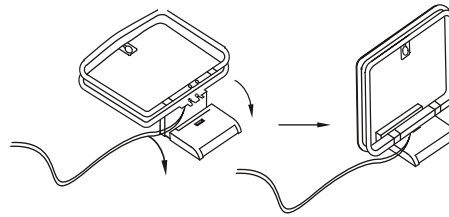

Figure 16 – AM Antenna Assembly

STEP SIX – Plug in AC Power Cords

Before plugging the AVR into an unswitched electrical outlet, make sure the Main Power Switch behind the front-panel door is off, to prevent the possibility of damaging the AVR in case of a transient power surge.

Plug the AC Power cord into an unswitched AC outlet.

It is recommended that you copy the appropriate information from the Table 2 worksheet to Table A5 in the appendix for future reference, in the event changes are made to the system components.

STEP SEVEN – Insert Batteries in Remote

The AVR 160 remote control uses three AAA batteries (included).

To remove the battery cover located on the back of the remote, firmly press the ridged depression and slide the cover toward the top of the remote.

Insert the batteries as shown in Figure 17, observing the correct polarity.



Figure 17 – Remote Battery Compartment

Point the remote's lens toward the front panel of the AVR 160. Make sure no objects, such as furniture, are blocking the remote's path to the receiver. Bright lights, fluorescent lights and plasma video displays may interfere with the remote's functioning. The remote has a range of about 7 meter, depending on the lighting conditions. It may be used at an angle of up to 30 degrees to either side of the AVR.

If the remote seems to operate intermittently, or if pressing a button on the remote does not cause the AVR Settings Button or one of the Source Selectors to light, check or replace the batteries.

STEP EIGHT – Program Sources Into the Remote

The AVR 160 remote may be programmed to control many brands and models of DVD players, cable boxes, satellite receivers, the Harman Kardon DMC 1000 digital media center and TVs.

To access the functions for a particular device, switch the remote's device mode. Press the AVR Button to access the codes that control the receiver, or the Source Selector Buttons to access the codes for the devices programmed into the remote.

While the DVD Source Selector may be used to operate either a Harman Kardon Blu-ray Disc player or a DVD player, the default mode is to operate a Harman Kardon Blu-ray Disc player. To toggle between Harman Kardon Blu-ray Disc player and DVD player operation, press and hold the DVD Source Selector for 2 seconds. The source selector will flash twice to confirm that the remote's mode has changed to operate the other type of disc player.

NOTE: The remote may be easily programmed to operate the Harman Kardon DVD players using the Video 1 or any of the HDMI Input Selectors, by following the instructions below. Select the VCR/PVR/DMC device type in number 4. Enter code 002.

If you have other source devices in your system, follow these steps to program the correct codes into the remote.

1. Using the codes in Tables A11–A17 of the Appendix, look up the product type (e.g., DVD, cable TV box) and the brand name of your source. The number(s) listed is/are potential candidates for the correct code set for your particular device.
2. Turn on your source device.
3. This step places the remote in program mode. Press and hold the Source Selector until the Program Indicator LED on the remote starts to flash, then release it. When pressed, the Source Selector will light red briefly, go dark, and then relight when the Program Indicator LED starts to flash.
4. Program the desired device type for any of the three HDMI selectors by pressing the corresponding Source Selector:
 - Press DVD to operate a DVD player.
 - Press VID1 to operate a VCR or PVR, or a Harman Kardon digital media center.
 - Press VID2 to operate a cable or satellite set-top box.
5. Enter a code from number 1 above.
 - a) If the device turns off, then press the Source Selector again to accept the code; it will flash. The remote will exit the Program mode.
 - b) If the device does not turn off, try entering another code. If you run out of codes, you may search through all of the codes in the remote's library for that product type by pressing the ▲ or ▼ Button repeatedly until the device turns off. When the device turns off, enter the code by pressing the Source Selector; it will flash. The remote then exits Program mode.
6. Once you have programmed a code, try using some other functions to control the device. Sometimes manufacturers use the same Power code for several different models, while other codes vary. Repeat this process until you've programmed a satisfactory code set that operates most of the functions you frequently use.

7. Find out which code number you have programmed by pressing and holding the Source Selector to enter the Program mode. Press the OK Button, and the Program Indicator LED will flash in the code sequence. One flash represents "1", two flashes for "2", and so forth. A series of many fast flashes represents "0". Record the codes programmed for each device in Table A7 in the Appendix.

If you are unable to locate a code set that correctly operates your source device, it will not be possible to use the AVR remote to control that device. You may still connect the source to the AVR 160 and operate it using the device's original remote control.

Most of the button labels on the remote describe the button's function when used to control the AVR 160. However, the button may perform a very different function when used to control another device. Refer to the Remote Control Function List, Table A10 in the Appendix, for each button's functions with the various product types.

You may program Macros, which are preprogrammed code sequences that execute many code commands with a single button press. You may also program "punch-through" codes, which allow the remote to operate the volume, channel or transport controls of another device without having to switch the remote's device mode. See pages 35 through 36 for instructions on these advanced programming functions.

Note: The AVR 160 remote is preprogrammed to operate the transport controls of Harman Kardon Blu-ray Disc or DVD players when the AVR or the Video 2 (cable/satellite) or Video 3 (TV) source is selected. You may change this punch-through programming at any time.

STEP NINE – Turn On the AVR 160

Two steps are required the first time you turn on the AVR 160.

1. Flip the rear-panel Main Power Switch to the "On" position. The Power Indicator on the front panel will turn amber, indicating that the AVR is in Standby mode and is ready to be turned on. Normally, you may leave the Main Power Switch on, even when the receiver is not being used.
2. There are several ways to turn on the AVR from Standby mode.
 - a) Press the Standby/On Switch on the front panel.
 - b) Using the remote, press the AVR Power On Button or any of the Source Selectors.

NOTES:

- Any time you press one of the Source Selectors on the remote, the remote will switch device modes. To control the receiver, press the AVR Button.
- If you do not see a picture within about 1 minute, refer to the Video Troubleshooting Tips on page 27.

In this section, you will configure the AVR 160 to match your actual system. A video display must be connected to one of the video monitor outputs on the receiver.

USING THE ON-SCREEN MENU SYSTEM

Although it's possible to configure the AVR using only the remote and the front-panel messages, it is easier to use the full-screen menu system.

The menu system is accessed by pressing the OSD Button on the remote or front panel.

The Master menu will appear (see Figure 18).



Figure 18 – Master Menu

The Master menu consists of five submenus: Input Setup, Surround Select, EzSet/EQ, Manual Setup and System Setup.

Use the ▲ ▼ ◀ ▶ Buttons on the remote or front panel to navigate the menu system, and press the OK Button to select a menu or setting line, or to enter a new setting.

The current menu, setting line or setting will appear in the Message Display, as well as on screen.

To return to the previous menu, navigate to the "BACK TO MASTER MENU" line and press the OK Button. To exit the menu system, press the OSD Button.

Most users should follow the instructions in this Initial Setup section to configure a basic home theater system. You may return to these menus at any time to make additional adjustments, such as those described in the Advanced Functions Section.

Before beginning initial setup, all loudspeakers, a video display and all source devices should be connected. You should be able to turn on the receiver and view the Master Menu when you press the OSD Button. If necessary, reread the Installation Section and the beginning of this section before continuing.

Configure the AVR 160, Using EzSet/EQ Technology

One of the most important steps in setting up a home theater system is to calibrate the receiver to match the loudspeakers, optimizing sound reproduction.

Until recently, most receivers required manual calibration and configuration, a tedious process that called for a good ear or the purchase of an SPL (sound-pressure level) meter. Although you may configure the AVR 160 manually, as described in the Advanced Functions section, it is recommended that you take advantage of the signature Harman Kardon EzSet/EQ system.

Eliminate extraneous background noise, such as noisy air conditioning. Avoid making any loud noises while running EzSet/EQ setup.

IMPORTANT SAFETY NOTE: During the EzSet/EQ procedure, a series of very loud test sweeps will be played through all of the speakers. Avoid sitting or standing close to any one speaker during the procedure. If you are particularly sensitive to loud noises, you may wish to leave the room and have someone else run the EzSet/EQ process.

STEP ONE – Place the included EzSet/EQ microphone in the listening position or in the center of the room, at about the same height as the listeners' ears. The microphone features a threaded insert on the bottom, for mounting on the extension rod or a camera tripod.

STEP TWO – Plug the EzSet/EQ microphone into the EzSet/EQ Microphone Input Jack on the front of the receiver, and set the level control on the subwoofer to the halfway point.

STEP THREE – Turn on the AVR 160 and the video display. Press the OSD Button to display the Master menu. Use the ▼ Button to highlight the EZSET/EQ LINE, then press the OK Button. See Figure 19.

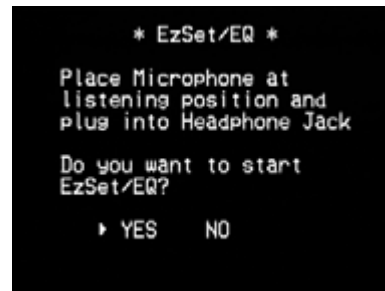

Figure 19 – EzSet/EQ Screen

Select "YES", and a warning screen, followed by the screen shown in Figure 20, will appear.

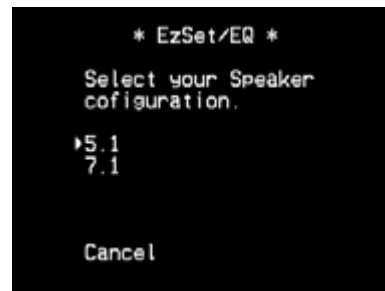

Figure 20 – EzSet/EQ Screen

To return to the SPEAKER SETUP menu without starting the EzSet/EQ process, select "Cancel". When you are ready to begin, select the number of speakers in your system. Select 5.1 if no surround back speakers are present or if the surround back channels will be used for multizone operation.

NOTE: If there are fewer than five main speakers in your system, do not use the EzSet/EQ process. Instead, proceed as described in the Advanced Functions section. If you have selected a 6.1-channel configuration with a single surround back speaker, use EzSet/EQ automatic configuration for 5.1 speakers, connect the single surround back speaker to the left Surround Back Speaker Output, then configure the surround back speaker manually, as described in the Advanced Functions section. The 6.1-channel configuration is not recommended. If the subwoofer is to be connected to the Front Speaker Outputs, do not connect the subwoofer until after running the EzSet/EQ process.

The AVR 160 will automatically set its master volume to –25dB.

The test will begin, and a screen such as the one shown in Figure 21 will appear. Maintain silence during the EzSet/EQ configuration.

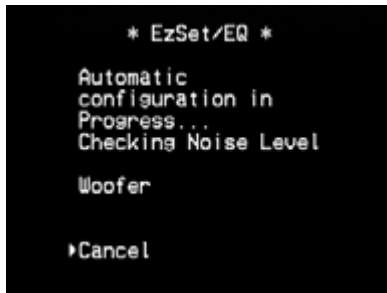

Figure 21 – EzSet/EQ in Progress

As the EzSet/EQ system tests each speaker, its position will appear on screen. If the test sweep is heard from a different speaker than the one indicated on screen, turn off the AVR and check the speaker-wire connections, then begin again.

When the Speaker Detection test is completed, select the Continue option. The results will be displayed, along with these options:

- The Retest option repeats the EzSet/EQ process. Increase the master volume manually, if some speakers were not correctly detected.
- Select Cancel to return to the Speaker Setup menu.

See the Advanced Functions section for instructions on how to manually configure the speakers or manually adjust the settings established by the EzSet/EQ process.

Set Up Sources

The Info Settings menu is used to assign the correct physical audio and video connections to each source.

The AUDIO IN setting must be adjusted now, and if a component video input was used for the source, the COMPONENT IN setting must also be adjusted. Otherwise, there will be no sound or picture when the source is playing. The other settings may be adjusted later.

To display the Input Setup menu, press the OSD Button. Select the INPUT SETUP LINE and press the OK Button. A screen similar to the one shown in Figure 22 will appear.



Figure 22 – Input Setup Menu

Source: Indicates the currently selected source. Use the ◀ ▶ Buttons to select a source: DVD, CD, TUNER (Radio), Tape, 8 CH DIRECT, AUX, VIDEO 1, VIDEO 2, VIDEO 3, HDMI 1, HDMI 2, HDMI 3.

Title: You may change the display name for any source (except the tuner). This may help you to select the correct source device even when you have forgotten which physical connections you used. Move the cursor to the TITLE line and press the OK Button. A block cursor will blink. Use the ▲ ▼ Buttons to scroll through the alphabet in upper and lower case, the numbers and many punctuation marks. When you have selected the desired character, press the ▶ Button to move to the next space. Press the ▶ Button to leave a blank space. Press the OK Button when you have finished.

Component In: If you connected the source to one of the two component video inputs, press the ▶ Button to adjust the setting if needed.

NOTE: If the source is connected to a composite video input but a signal is present at the selected component video input, the AVR will display the component video signal. To avoid this, turn off the component video source device, or adjust this setting to select a component video input that is not in use. When no component video signal is present, the AVR will automatically select the composite video input associated with the source.

Audio In: If you used a digital audio connection for a source, change this setting to assign the correct digital audio input, even if you also connected it analog audio outputs to the receiver. Move the cursor to this line, and press the ◀ ▶ Buttons until the correct digital input appears. If an analog audio connection was used, change this setting to ANALOG.

Auto Poll: The Auto Poll feature is used when both an analog audio and digital audio connection have been made for one source device. If no digital signal is available, the AVR 160 will switch to the analog input for the source. This situation can occur with some cable or satellite television broadcasts, where some channels are broadcast with digital audio and others with analog audio, or when a DVD player is paused or stopped.

For some sources, the Auto Poll feature is unnecessary and may be undesirable, such as for a DVD player. Move the cursor to this line, and press the ◀ ▶ Buttons until OFF appears, disabling the Auto Poll feature. With Auto Poll turned off, the receiver will only check for a signal at the audio input assigned to the source.

The remaining lines in the Input Setup menu adjust the audio performance, and may be skipped at this time. Leaving these settings at their factory defaults is recommended for most listening, in order to enjoy the sound mix created by your favorite movie and music artists.

BXR: Enhances bass performance when playing MP3 tracks. Select ON, or leave at the default OFF setting for non-MP3 audio.

Tone: Determines whether the treble and bass controls are active. When it's off, the tone controls are "flat", with no changes. When it's on, the bass and treble frequencies are boosted or cut, depending upon the tone-control settings. When an analog audio source is in use and the 2-Channel Stereo surround mode is selected, setting the Tone to OFF places the unit in analog bypass mode.

Bass and Treble: Boost or cut the low or high frequencies by up to 10dB by using the ◀ ▶ Buttons to change the setting by 2dB at a time.

6-/8-Channel Inputs

The 6-/8-Channel Analog Audio Inputs are used when playing certain multichannel discs (DVD-Audio, Blu-ray Disc, SACD and HD-DVD) on a player that decodes the audio and outputs it via its multichannel analog audio outputs but not via its HDMI output.

HDMI-Equipped Multichannel Disc Player:

- Connect the player's HDMI output to one of the AVR's HDMI Inputs. No other connections are necessary.
- Make sure the HDMI input is selected as the source and the Audio Input in the Input Setup menu.

HDMI-Equipped Multichannel Disc Player That Does Not Output Multichannel Audio via an HDMI Connection:

- Connect the player's HDMI output and its multichannel analog audio outputs to one of the AVR's HDMI Inputs and to the AVR's 6-/8-Channel Analog Audio Inputs. In addition, connect the player's component video outputs to one of the AVR's Component Video Inputs.
- When listening to DVD-Video discs, CDs or other materials outputting standard-definition digital audio, select the HDMI Input as the source and as the Audio Input.
- To listen to high-resolution multichannel discs, select the 6-/8-Channel Analog Audio Inputs as the source, and select the component video input the player was connected to. It is not possible to view HDMI video while listening to multichannel analog audio.

Multichannel Disc Player Without HDMI Output, or When Video Display Has No HDMI Input:

- Connect the player's component video outputs to one set of Component Video Inputs on the AVR. Depending on the capabilities of the player and your video display, you may need to use the DVD composite video connection instead.
- Connect the player's digital audio output to a digital audio input on the AVR.
- Connect the player's multichannel audio outputs to the AVR's 6-/8-Channel Analog Audio Inputs.
- When listening to DVD-Video discs, CDs or other materials outputting standard-definition digital audio, select the DVD source, and make sure the digital audio input the player is connected to is selected as the audio input in the Input Setup menu. If a component video connection was made, select the correct input at the COMPONENT IN line of the Input Setup menu. If the DVD Video input was used, it will automatically be selected.
- To listen to high-resolution multichannel discs, select the "8 CH DIRECT" source.

NOTE: The 6-/8-Channel Inputs pass the incoming signals directly to the volume control, without digitizing or processing them. It is not possible to change the surround mode or adjust any of the tone controls when using the 6-/8-Channel Inputs. Configure the bass management settings (i.e., speaker size, delay and output level) on your source device to match the settings programmed using the EzSet/EQ procedure, which may be viewed using the Speaker Setup menu (see Advanced Functions section). Consult the owner's guide for your multichannel player for more information.

System Settings

The AVR 160 offers system settings that make the receiver easier to use. Access these settings by pressing the OSD Button and navigating to the SYSTEM SETUP line of the Master menu. Press the OK Button to display the submenu. See Figure 23.



Figure 23 – System Setup Menu Screen

VFD Fade Time Out: Some people find the brightness of the AVR's front-panel display distracting during movies or listening sessions. It's possible to dim the front-panel display completely using the Dim function (see below). This sets the display to remain dark most of the time, lighting up only when a button is pressed or a remote command is received, and going dark again 5 seconds after the last command. The VFD FADE TIME OUT feature also causes the display to light up only when a button is pressed or a change in the incoming signal is detected, but the display immediately begins to fade to dark. This setting allows you to program the length of the fade time. Select a time-out period of between 3 and 10 seconds, or select OFF if you prefer to leave the displays on at all times or to use the Dim function.

Volume Default and Default Volume Set: These two settings are used together to program the AVR's volume level at turn-on. This feature avoids discomfort for listeners in case the last user turned the volume very high. Press the OSD Button to remove the display from the screen so that you may adjust the volume to a desired level while a source is playing. Make a note of the number that appears in the display, and return to the System Setup menu. At the DEFAULT VOL SET line, select the desired volume setting, and activate the feature by setting VOLUME DEFAULT to ON.

HDMI Audio to TV: Determines whether HDMI audio signals are passed through the HDMI Output to the video display. In normal operation, leave this setting OFF, as audio will be played through the AVR. To use the TV by itself, without the home theater system, turn this setting ON. Mute the TV's speakers when using the AVR for audio.

Semi-OSD Time Out: Program the amount of time (2 to 5 seconds) the two-line semi-OSD status messages remain on screen, or deactivate the semi-OSD display altogether if you find it distracting. These messages will continue to appear on the front panel of the receiver.

Full-OSD Time Out: Program the amount of time (20, 30, 40 or 50 seconds) the full-OSD menus remain visible on screen. The full-OSD system may not be deactivated.

NOTE: It isn't possible to view video sources while the full-OSD menus are displayed.

Dim Function

To dim the Message Display, press the Dim Button on the remote. Each button press will cycle through the three settings of:

- **VFD Full:** Normal brightness
- **VFD Half:** Display is dimmed but still visible; the light inside the volume knob goes dark
- **VFD Off:** Display goes completely dark except for Power Indicator, to remind you that the receiver is turned on.

When you have finished, press the OSD Button to clear the menus from view.

You are now ready to begin enjoying your new receiver!

Now that you have installed your components and completed a basic configuration, you are ready to begin enjoying your home theater system.

TURNING ON THE AVR 160

Flip the rear-panel Main Power Switch to the "On" position. The Power Indicator on the front panel will turn amber, indicating that the AVR is in Standby mode and is ready to be turned on. The Main Power Switch is normally left on.

There are several ways to turn on the AVR 160:

- a) Press the Standby/On Switch on the front panel.
- b) Using the remote, press the AVR Power On Button or any of the Source Selectors.

To turn the receiver off, press either the Standby/On Switch on the front panel or the Power Off Button on the remote control. Unless the receiver will not be used for an extended period of time, leave the Main Power Switch on. When the Main Power Switch is turned off, any settings you have programmed will be preserved for up to four weeks.

IMPORTANT NOTE: If the PROTECT message ever appears in the Message Display, turn off the AVR and unplug it. Check all speaker wires for a short. If none is found, bring the unit to an authorized Harman Kardon service center for inspection and repair before using it again.

VOLUME CONTROL

Adjust the volume either by turning the knob on the front panel (clockwise to increase volume or counterclockwise to decrease volume), or by pressing the Volume Control on the remote. The volume is displayed as a negative number of decibels (dB) below the 0dB reference point.

0dB is the maximum recommended volume for the AVR 160. Although it's possible to turn the volume to a higher level, doing so may damage your hearing and your speakers. For certain more dynamic audio materials, even 0dB may be too high, allowing for damage to equipment. Use caution with regard to volume levels.

MUTE FUNCTION

To temporarily mute all speakers and the headphones, press the Mute Button on the remote. Any recording in progress will not be affected. The MUTE message will appear in the display as a reminder. To restore normal audio, press the Mute Button again, or adjust the volume. Turning off the AVR will also end muting.

SLEEP TIMER

The sleep timer sets the AVR to play for up to 90 minutes and then turn off automatically.

Press the Sleep Settings Button on the remote, and the time until turn-off will be displayed. Each additional press of the Sleep Button decreases the play time by 10 minutes, with a maximum of 90 minutes. The SLEEP OFF setting disables the sleep timer.

If you press the Sleep Button after the timer has been set, the remaining play time will be displayed. Press the Sleep Button again to change the play time.

TONE CONTROLS

You may boost or cut either the treble or the bass frequencies by up to 10dB.

Press the Tone Mode Button once. This will indicate whether the tone controls are in or out of the circuitry. With the TONE IN message displayed, press the Tone Mode Button repeatedly to access TREBLE MODE and BASS MODE. Use the ▲ ▼ Buttons to change the treble or bass settings.

To return the tone controls to 0, or "flat" response, press the Tone Mode Button, and then use the ▲ ▼ Buttons to display the TONE OUT message, which preserves any changes you have made to the bass or treble settings for later use. To reactivate your changes, the tone control must be set to TONE IN.

The display will return to normal a few seconds after your last command.

You may also adjust the tone controls using the full-OSD menu system. Press the OSD Button on the remote to view the Master menu. With the cursor pointing to the INPUT SETUP line, press the OK Button to display the Input Setup menu and view the current tone settings. To make changes to the TONE, BASS or TREBLE settings, use the ▲ ▼ Buttons to move the cursor to the setting, and use the ◀ ▶ Buttons to adjust it. It isn't necessary to press the OK Button to enter the new setting.

When you have finished, either wait until the display times-out and disappears, press the OSD Button to clear the display, or move the cursor to the BACK TO MASTER MENU line and select it to make other changes using the menu system.

NOTE: The AVR 160 does not have a conventional balance control. The speaker output level calibration process compensates for any characteristics of your room or loudspeakers, and it is recommended that you leave the settings as they are after you have completed Initial Setup. However, you may manually adjust the levels of the left and right channels – decreasing one and increasing the other by the same amount – using the Channel Adjust submenu, as described in the Advanced Functions section. This achieves the same effect as a balance control.

HEADPHONES

Plug the 1/4" (6,3 mm) plug on a pair of headphones into the jack behind the front-panel door for private listening. The default Headphone bypass mode delivers a conventional 2-channel signal to the headphones.

Press the Surround Modes Button on the front panel or the remote, to switch to Harman Headphone virtual surround processing, which emulates a 5.1-channel speaker system. No other surround modes are available for the headphones.

SOURCE SELECTION

- Use the front-panel ▲ ▼ Source Buttons to scroll through the sources.
- Using the on-screen menus, press the OSD Button, highlight "INPUT SETUP" and press the OK Button. Use the ◀ ▶ Buttons to select a source.
- For direct access to any source, press its Source Selector on the remote.

The AVR selects the audio and video inputs assigned to the source, and any other settings made during setup.

The source name, the audio and video inputs assigned to the source, and the surround mode will appear on the front panel. The source name and surround mode will also appear on screen.

VIDEO TROUBLESHOOTING TIPS:

If there is no picture:

- Check the source selection and video input assignment.
- Check the wires for a loose or incorrect connection.
- Check the video input selection on the display device (TV).

Additional Tips for HDMI Connections:

- Turn off all devices (including the TV, AVR and any source components).
- Unplug the HDMI cables, starting with the cable between the TV and AVR, and continuing with the cables between the AVR and each source device.
- Carefully reconnect the cables from the source devices to the AVR. Connect the cable from the AVR to the TV last.
- Turn on the devices in this order: TV, AVR, source devices.

USING THE RADIO

To select the AVR 160's built-in radio:

1. Use the front-panel ▲ ▼ Buttons to scroll to the desired tuner band.
2. Press the Radio Source Selector on the remote. Press it again to switch bands.

Use the ▲ ▼ Buttons or the Channel Control to tune a station, as displayed on the front panel and on screen.

The AVR defaults to automatic tuning, meaning each press of the ▲ ▼ Buttons scans through all frequencies until a station with acceptable signal strength is found. To switch to manual tuning, in which each press of the ▲ ▼ Buttons steps through a single frequency increment (0.05MHz for FM, or 10kHz for AM), press the Menu Button. The Mode line will display the current setting. Each press of the OK Button toggles between automatic and manual tuning modes.

When an FM station has been tuned, toggling the tuning mode also switches between stereo and monaural play, which may improve reception of weaker stations.

A total of 30 stations (AM and FM together) may be stored as presets. When the desired station has been tuned, press the OK Button, and two dashes will flash. Use the Numeric Keys to enter the desired preset number.

To tune a preset station: Press the Preset ▲ ▼ Buttons or enter the preset number using the Numeric Keys.

RDS Operation

The AVR 160 is equipped with RDS (Radio Data System), which brings a wide range of information to FM radio. Now in use in many countries, RDS is a system for transmitting station call signs or network information, a description of station program type, text messages about the station or specifics of a musical selection, and the correct time.

As more FM stations become equipped with RDS capabilities, the AVR will serve as an easy-to-use center for both information and entertainment. This section will help you take maximum advantage of the RDS system.

RDS Tuning

When an FM station is tuned in and it contains RDS data, the AVR will automatically display the station's call sign or other program service in the Message Display.

RDS Display Options

The RDS system is capable of transmitting a wide variety of information in addition to the initial station call sign that appears when a station is first tuned. In normal RDS operation the display will indicate the station name, broadcast network or call letters. Pressing the RDS Button on the Remote enables you to cycle through the various data types in the following sequence:

- The station's call letters (PS) (with some private stations other information too).
- The station's frequency (FREQ MODE), which is always shown on the TV On-Screen Display, is shown in the Message Display.
- The Program Type (PTY).

NOTE: Many stations do not transmit a specific PTY. The display will show NONE, when such a station is selected and PTY is active.

- A "text" message (Radiotext, RT) containing special information from the broadcast station. Note that this message may scroll across the display to permit messages longer than the eight positions in the display. Radiotext is not shown on the TV On-Screen Display.
- The current time of day (CT). Note that it may take up to two minutes for the time to appear, in that time the letters CT are shown in the information display when CT is selected. Please note that the accuracy of the time data is dependent on the radio station, not the AVR.

Some RDS stations may not include some of these additional features. If the data required for the selected mode is not being transmitted, the Message Display will show a NO TYPE, NO TEXT or NO TIME message after the individual time out.

In any FM mode the RDS function requires a strong enough signal for proper operation.

Program Search (PTY)

An important feature of RDS is its capability of encoding broadcasts with Program Type (PTY) codes that indicate the type of material being broadcast.

You may search for a specific Program Type (PTY) by following these steps:

1. Press the RDS button until PTY is shown in the Main Information Display.
2. While PTY is shown, press the Preset Up/Down Buttons or hold them pressed to scroll through the list of available PTY types.
3. Press either of the Tuning ▲ ▼ Buttons. The tuner begins to scan the FM band upwards or downwards for the first station that has RDS data that matches the desired selection, and acceptable signal strength for quality reception.
4. The tuner will make up to one complete scan of the entire FM band for the next station that matches the desired PTY type and has acceptable reception quality. If no such station is found, the display will read NONE for some seconds and the tuner will return to the last FM station in use before the search.

RECORDING

Two-channel analog and digital audio signals, as well as composite signals, are normally available at the appropriate recording outputs. To make a recording, connect your audio or video recorder to the appropriate output jacks, as described in the Installation section, insert blank media and make sure the recorder is turned on and recording while the source is playing.

NOTES:

1. Analog and digital audio signals are not converted to the other format.
2. Only PCM digital audio signals are available for recording. Proprietary formats such as Dolby Digital and DTS may not be recorded using the digital audio connections. Use the analog audio connections to make an analog recording.
3. HDMI and component video sources that are HDCP-copyprotected are not available for recording.
4. Please make certain that you are aware of any copyright restrictions on any material you record. Unauthorized duplication of copyrighted materials is prohibited.

AUX INPUT

Enjoy the full power and resolution of your Harman Kardon system, including a variety of analog surround modes, while listening to content stored on your portable device.

The Auxiliary Audio Input mini jack is provided on the AVR's rear panel for convenient connection of portable players, such as CD players and the iPod (iPod and cable not included). Purchase a stereo cable with a 1/8" (3,5 mm) plug on at least one end for connection to the Auxiliary Audio Input. Plug the other end of the cable into the portable device's headphone output, and operate the device using its own controls. You may also use a cable with separate left and right audio plugs at one end for connection to any component equipped with analog audio outputs.

No video connection is available with the AUX input. However, the AVR will use the last-selected analog video input when the AUX source is selected.

SELECTING A SURROUND MODE

Surround mode selection can be as simple or sophisticated as your individual system and tastes. Feel free to experiment, and you may find a few favorites for certain sources or program types. More detailed information on surround modes may be found in the Advanced Functions Section.

To select a surround mode, press the OSD Button on the remote to display the Master menu. Use the ▲▼ Buttons to move the cursor to the SURROUND SELECT line and press the OK Button. The Surround Modes menu will appear (see Figure 24). Use the ▲▼ Buttons until the desired surround mode category appears: Auto Select, Virtual Surround, Stereo, Movie, Music or Video Game. Press the OK Button to change the surround mode for the category.



Figure 24 – Surround Modes Menu

Auto Select: For digital programs, such as movies recorded with a Dolby Digital soundtrack, the AVR will automatically use the native surround format. For 2-channel analog and PCM programs, the AVR uses Logic 7 Movie, Music mode.

Virtual Surround: When only two main speakers are present in the system, Harman Virtual Surround may be used to create an enhanced soundfield that virtualizes the missing speakers.

Stereo: When 2-channel playback is desired, select the number of speakers used for playback:

- 2 CH STEREO uses only two speakers. As described on page 30, you may select Analog Bypass mode for a pure analog signal when analog audio inputs are in use. Turn off the TONE setting, and the AVR does the rest.
- 5 CH STEREO plays the left-channel signal through the front and surround left speakers, the right-channel signal through the right speakers and a summed mono signal through the center speaker.
- 7 CH STEREO follows the same scheme as 5 CH STEREO, but adds the surround back speakers. This mode is only available when the surround back speakers are present.

Movie: Use when a surround mode is desired for movie playback: Logic 7 Movie, DTS Neo:6 Cinema or Dolby Pro Logic II (IIx when seven main speakers are present).

Music: Use when a surround mode is desired for music playback: Logic 7 Music, DTS Neo:6 Music or Dolby Pro Logic II (IIx when seven main speakers are present). The Dolby Pro Logic II/IIx Music mode allows access to a submenu with some additional settings. See the Advanced Functions section for more information.

Video Game: Use to select a surround mode for game playback: Logic 7 Game, or Dolby Pro Logic II (IIx when seven main speakers are present) Game.

After you have made your selection, use the ▲▼ Buttons to move the cursor to the BACK TO SURROUND SELECT line and press the OK Button, then select the BACK TO MASTER MENU line and press the OK Button to make additional adjustments. When you are finished using the menu system, press the OSD Button to clear the full-OSD menus from view (the semi-OSD display will appear).

See the Advanced Functions section for more information on surround modes.

Much of the AVR 160's performance is handled automatically, with little intervention required on your part. The AVR 160 is capable of being customized to suit your system and your tastes. In this section, some of the more advanced adjustments available are described.

AUDIO PROCESSING AND SURROUND SOUND

Audio signals output by sources are encoded in a variety of formats that can affect not only the quality of the sound but the number of speaker channels and the surround mode. You may also manually select a different surround mode, when available.

Analog Audio Signals

Analog audio signals usually consist of two channels – left and right. The AVR 160 offers three options for playback:

- 1. Analog Bypass Mode:** The 2-channel signal is passed directly from the input to the volume control, without being digitized or undergoing any processing for bass management or surround sound. To select analog bypass mode:
 - a) The analog audio inputs for the source must be selected. If necessary, with the remote in AVR device mode, press the Digital Select Button and use the ▲ ▼ Buttons to select "ANALOG".
 - b) The tone controls must be disabled by turning off the Tone setting. With the remote in AVR device mode, press the Tone Button and use the ▲ ▼ Buttons to select "TONE OUT".
 - c) The 2-channel Stereo mode must be selected. Press the OSD Button, and use the ▲ ▼ Buttons to select "SURROUND SELECT". Press the OK Button. Use the ▲ ▼ Buttons to select "STEREO", and press the OK Button. Use the ◀ ▶ Buttons to select either the 2- or 7-Channel Stereo mode.
- 2. DSP Surround Off Mode:** The DSP Surround Off mode digitizes the incoming signal and applies the bass management settings, including speaker configuration, delay times and output levels. Select this mode when your front speakers are small, limited-range satellites and you are using a subwoofer. To select this mode, use a digital audio input, or set the Tone setting to IN, and select 2-channel Stereo mode.
- 3. Analog Surround Modes:** The AVR 160 is able to process 2-channel audio signals to produce multichannel surround sound, even when no surround sound has been encoded in the recording. Among the available modes are the Dolby Pro Logic II/Ix modes, the Harman Virtual Speaker modes, the DTS Neo:6 modes, the Logic 7 modes and the Stereo modes.

Digital Audio Signals

Digital audio signals offer greater capacity, which allows the encoding of center and surround channel information directly into the signal. The result is improved sound quality and startling directionality, since each channel is reproduced discretely.

Even when only two channels are encoded, the digital signal allows for a higher sampling rate that delivers greater detail. High-resolution recordings sound extraordinarily distortion-free, especially at high frequencies.

Surround Modes

Surround mode selection is dependent upon the format of the incoming audio signal, as well as personal taste. Table A9 offers a brief description of each mode and indicates the types of incoming signals or digital bitstreams the mode may be used with. Additional information about the Dolby and DTS modes is available on the companies' Web sites: www.dolby.com and www.dtsonline.com.

When in doubt, check the jacket of your disc for more information on which surround modes are available. Usually, nonessential sections of the disc, such as trailers, extra materials or the disc menu, are only available in Dolby Digital 2.0 (2-channel) or PCM 2-channel mode. If the main title is playing and the display shows one of these surround modes, look for an audio or language setup section in the disc's menu. Also, make sure your player's audio output is set to the original bitstream rather than 2-channel PCM. Stop play and check the player's output setting.

For any incoming signal, only a limited number of surround modes are available. Although there is never a time when all of the AVR 160's surround modes are available, there is usually a wide variety of modes available for a given input.

Multichannel digital recordings are found in the 5.1-, 6.1- or 7.1-channel formats. The channels included in a 5.1-channel recording are front left, front right, center, surround left, surround right and LFE. The LFE channel is denoted as ".1" to represent the fact that it is limited to the low frequencies.

6.1-Channel recordings add a single surround back channel, and 7.1-channel recordings add surround back left and surround back right channels to the 5.1-channel configuration. New formats are available in 7.1-channel configurations. The AVR 160 is able to play the new audio formats, delivering a more exciting home theater experience.

NOTE: To use the 6.1- and 7.1-channel surround modes, the Surround Back channels must be enabled. See the Manual Speaker Setup section on page 33 for more information.

The digital formats include Dolby Digital 2.0 (two channels only), Dolby Digital 5.1, Dolby Digital EX (6.1), Dolby Digital Plus (7.1), Dolby TrueHD (7.1), DTS-HD High-Resolution Audio (7.1), DTS-HD Master Audio (7.1), DTS 5.1, DTS-ES (6.1 Matrix and Discrete), DTS 96/24 (5.1), 2-channel PCM modes in 32kHz, 44.1kHz, 48kHz or 96kHz, and 5.1 or 7.1 multichannel PCM.

When a digital signal is received, the AVR 160 detects the encoding method and the number of channels, which is displayed briefly as three numbers, separated by slashes (e.g., "3/2/.1").

The first number indicates the number of front channels in the signal:

"1" represents a monophonic recording, usually an older program that has been digitally remastered or, more rarely, a modern program for which the director has chosen a special effect.

"2" indicates the presence of the left and right channels, but no center channel.

"3" indicates that all three front channels (left, right and center) are present.

The second number indicates whether any surround channels are present:

“0” indicates that no surround information is present.

“1” indicates that a matrixed surround signal is present.

“2” indicates discrete left and right surround channels.

“3” is used with DTS-ES bitstreams to represent the presence of the discrete surround back channel, in addition to the side surround left and right channels.

“4” is used with 7.1-channel digital formats to indicate the presence of two discrete side surround channels and two discrete back surround channels.

The third number is used for the LFE channel:

“0” indicates no LFE channel.

“.1” indicates that an LFE channel is present.

The 6.1-channel signals – Dolby Digital EX and DTS-ES Matrix and Discrete – each include a flag meant to signal the receiver to decode the surround back channel, indicated as 3/2/.1 EX-ON for Dolby Digital EX materials, and 3/3/.1 ES-ON for DTS-ES materials.

Dolby Digital 2.0 signals may include a Dolby Surround flag indicating DS-ON or DS-OFF, depending on whether the 2-channel bitstream contains only stereo information, or a downmix of a multichannel program that can be decoded by the AVR’s Dolby Pro Logic decoder. By default, these signals are played in Dolby Pro Logic IIx Music mode.

When a PCM signal is received, the PCM message and the sampling rate (32kHz, 44.1kHz, 48kHz or 96kHz) will appear.

When only two channels – left and right – are present, the analog surround modes may be used to decode the signal into the remaining channels. If you would prefer a different surround format than the native signal’s digital encoding, press the OSD Button, and use the ▲▼ Buttons to select “SURROUND SELECT”. Press the OK Button. Use the ▲▼ Buttons to select one of the surround mode categories.

The Auto Select option uses the native signal’s digital encoding, e.g., Dolby Digital, DTS, Dolby TrueHD or DTS-HD Master Audio. For 2-channel materials, the AVR defaults to Logic 7 Movie mode. If you prefer a different surround mode, select the surround mode category: Virtual Surround, Stereo, Movie, Music or Video Game. Press the OK Button to change the mode.

Each category is set to a default surround mode:

- **Virtual Surround:** Harman Virtual Speaker
- **Stereo:** 7-channel stereo
- **Movie:** Logic 7 Movie
- **Music:** Logic 7 Music
- **Video Game:** Logic 7 Game

You may select a different mode. The choice of surround modes depends on the number of speakers in your system.

- **Virtual Surround:** Harman Virtual Speaker
- **Stereo:** 2-channel stereo, 5-channel stereo or 7-channel stereo
- **Movie:** Logic 7 Movie, DTS Neo: 6 Cinema, Dolby Pro Logic II Movie, Dolby Pro Logic IIx Movie
- **Music:** Logic 7 Music, DTS Neo:6 Music, Dolby Pro Logic II Music, Dolby Pro Logic IIx Music
- **Video Game:** Logic 7 Game, Dolby Pro Logic II Game, Dolby Pro Logic IIx Game

Once you have programmed the surround mode for each type of audio, select the line from the Surround Select menu to override the AVR’s automatic surround mode selection. The AVR will use the same surround mode the next time the source is selected.

Please refer to Table A9 in the appendix for more information on which surround modes are available with different bitstreams.

Dolby Surround Settings

Some additional settings are available for Dolby modes. When the Dolby Pro Logic II or IIx Music modes have been selected, the Center Width, Dimension, Panorama and Night Mode settings will become available. See Figure 25.



Figure 25 – Dolby Pro Logic II/IIx Music Mode Settings

Center Width: This setting affects how vocals sound through the three front speakers. A higher number (up to 7) focuses the vocal information tightly on the center channel. Lower numbers broaden the vocal soundstage. Use the ◀▶ Buttons to adjust.

Dimension: This setting affects the depth of the surround presentation, allowing you to “move” the sound toward the front or rear of the room. The setting of “0” is a neutral default. Setting “F-03” moves the sound toward the front of the room, while setting “R-03” moves the sound toward the rear. Use the ◀▶ Buttons to adjust.

Panorama: With the Panorama mode turned On, some of the sound from the front speakers is moved to the surround speakers, creating an enveloping “wraparound” effect. Each press of the OK Button toggles the setting on or off.

Night Mode: Night mode is available with some Dolby Digital programs, if it has been encoded in the material. It compresses the peak sound levels, maintaining the intelligibility of the dialogue and quieter passages, while reducing the loudness of special effects and louder passages, to avoid disturbing others. Three levels of compression are available:

- **Off:** At this setting, there is no compression, as the Night mode is deactivated.
- **Half:** A mild compression is applied.
- **Full:** More compression is applied.

MANUAL SPEAKER SETUP

The AVR 160 is flexible and may be configured for most speakers, and to compensate for the acoustic characteristics of your room.

The EzSet/EQ process automatically detects the capabilities of each speaker, and optimizes the AVR 160's performance. If you are unable to run EzSet/EQ calibration, or if you wish to make further adjustments, use the Manual Speaker Setup on-screen menus.

Before beginning, place your loudspeakers as explained in the Speaker Placement section, and connect them to the AVR. Consult the owner's guide for the speakers or the manufacturer's Web site for the frequency range specification. Although you may set the output levels "by ear," an SPL (sound-pressure level) meter purchased at a local electronics store will provide greater accuracy.

Record your configuration settings in Tables A4 and A6 in the appendix for easy re-entry after a system reset, or if the AVR's Master Power Switch is turned off or the unit is unplugged for more than four weeks.

STEP ONE – Determine Speaker Crossover

Without using the EzSet/EQ process, the AVR 160 can't detect how many speakers you've connected to it; nor can it determine their capabilities. Consult the speaker's technical specifications and locate the frequency response, usually given as a range, e.g., 100Hz – 20kHz (± 3 dB). Write down the lowest frequency that each of your main speakers is capable of playing (100Hz in the example) as the crossover in Table A6 in the appendix. This is not the same as the crossover frequency listed in the speaker's specifications. For the subwoofer, write down the transducer size.

The receiver's bass management determines which speakers will be used to play back the low-frequency (bass) portion of the source program. Sending the lowest notes to small satellite speakers won't sound right, and may even damage the speaker. The highest notes may not be heard at all through the subwoofer.

With proper bass management, the AVR 160 divides the source signal at a crossover point. All information above the crossover point is played through the satellite speaker, and all information below the crossover point is played through the subwoofer. Each loudspeaker in your system performs at its best, delivering an enjoyable sound experience.

STEP TWO – Measure Speaker Distances

Ideally, all of your speakers would be placed in a circle, with the listening position at the center. However, you may have had to place some speakers a little further away from the listening position than others. Sounds that are supposed to arrive simultaneously from different speakers may blur, due to different arrival times.

Use the AVR's delay adjustment to compensate for real-world speaker placements.

Measure the distance from each speaker to the listening position, and write it down in Table A4 in the appendix. Even if all of your speakers are the same distance from the listening position, enter your speaker distances as described in Step Three.

STEP THREE – Manual Setup Menu

Now you are ready to program the receiver. Sit in the usual listening position and make the room as quiet as possible.

With the receiver and video display turned on, press the OSD Button to display the Master menu. Use the \blacktriangledown Button to move the cursor to the MANUAL SETUP line, and press the OK Button to display the Manual Setup menu.

If you have run the EzSet/EQ process, the results were saved. To tweak the EzSet/EQ results, or to configure the AVR 160 from scratch, use the menu shown in Figure 26.

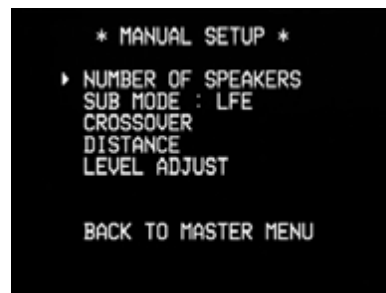

Figure 26 – Manual Setup Menu

NOTE: All of the speaker setup submenus include the option to go back to the previous menu, similar to what is shown at the bottom of Figure 26.

For best results, adjust the submenus in this order: Number of Speakers, Crossover, Sub Mode, Distance and Level Adjust.

Number of Speakers

Move the cursor to the Number of Speakers line and press the OK Button. See Figure 27.



Figure 27 – Number of Speakers Menu

Program the correct setting for each speaker group: ON when the speakers are present in the system, and OFF for positions where no speakers are installed. The Front Left & Right speakers are always ON and may not be disabled. Any changes will be reflected in the total number of speakers displayed at the top of the screen.

The settings in this menu affect the remainder of the speaker setup process and the availability of various surround modes at any time.

When you have finished, select the “BACK TO MANUAL SETUP” option.

Crossover Menu

After you have programmed the number of speakers, return to the Manual Setup menu (see Figure 29). Navigate to the CROSSOVER line and press the OK Button to display the Crossover menu. See Figure 28.



Figure 28 – Crossover Menu

The AVR will only display those speaker groups programmed in the Number of Speakers menu.

Refer to Table A6 for each speaker’s crossover. For the main speakers, this is the lowest frequency the speaker reproduces well.

For each main speaker, select one of the seven crossover frequencies: 40Hz, 60Hz, 80Hz, 100Hz, 120Hz, 150Hz or 200Hz. If the crossover frequency is below 40Hz, select the first option, “Large”. This setting doesn’t refer to the speaker’s physical size, but to its frequency response, which is also called “full range”.

You may specify the size of the subwoofer’s transducer as 8, 10, 12 or 15 inches. The AVR always sets the subwoofer crossover to 100Hz, but uses the transducer size for equalization. Write down the settings in Table A6 in the appendix.

When you have finished entering the settings, select BACK TO MANUAL SETUP.

Sub Mode

Move the cursor to the SUB MODE line in the Manual Setup menu. This setting depends upon how you programmed the front left and right speakers.

- If you set the front speakers to a numeric crossover frequency, the subwoofer setting will always be SUB. All low-frequency information will always be sent to the subwoofer. If you don’t have a subwoofer, either upgrade to full-range speakers or add a subwoofer at the earliest opportunity.
- If you set the front speakers to LARGE, select one of the three settings for the subwoofer.
 - ◆ **L/R+LFE:** This setting sends all low-frequency information to the subwoofer, including both information that would normally be played through the front left and right speakers, and the special low-frequency effects (LFE) channel information.
 - ◆ **Off:** Select this setting when no subwoofer is in use. All low-frequency information will be sent to the front left and right speakers.
 - ◆ **LFE:** This setting plays low-frequency information contained in the left and right program channels through the front speakers, and directs only the LFE channel to the subwoofer.

NOTE: If you are using a Harman Kardon HKTS Series speaker system, select the appropriate numeric crossover frequency for the Main Speaker groups, and the subwoofer will automatically be set to LFE.

Distance Menu

Placing the speakers at different distances from the listening positions can muddy the sound, as sounds are heard earlier or later than desired.

Even if all of your speakers are placed the same distance from the listening position, do not skip this menu.

On the Manual Setup menu, move the cursor to the DISTANCE line and press the OK Button to display the Distance menu. See Figure 29.



Figure 29 – Distance Menu

Enter the distance from each speaker to the listening position, as measured in Step Two – Measure Speaker Distances and recorded in Table A4 in the appendix (see page 32).

The default unit of measurement is feet. To change the unit to meters, scroll down to the Unit setting. Use the ◀ ▶ Buttons to toggle the setting between FEET and METERS.

Select a speaker, then use the ◀ ▶ Buttons to change the measurement. The values vary between 0 and 30 feet (10 m), with a default of 10 feet (3,3 m) for all speakers. To reset all of the settings to their default values, scroll down to the DELAY RESET setting and use the ◀ ▶ Buttons to change this setting to ON, where it will remain until any of the speaker delay settings are changed.

ADVANCED FUNCTIONS

A/V SYNC DELAY: This line allows you to compensate for a “lip sync” problem, in which a source device or the video display introduces a significant amount of video processing that causes the audio and video parts of the signal to lose synchronization. You may delay the audio for all channels by up to 180 milliseconds to compensate.

NOTE: Adjusting the A/V Sync Delay using the Delay Button on the remote is recommended, so as to view the picture while adjusting the audio delay. With the program playing, press the Delay Button, and the A/V SYNC DELAY message will appear on the front panel and in the semi-OSD display. Press the OK Button to display the current delay setting, and use the ◀ ▶ Buttons to adjust the setting until the picture and sound are back in sync.

STEP FOUR – Setting Channel Output Levels Manually

For a conventional 2-channel receiver, the balance control affects the stereo imaging by adjusting the relative loudness of the left and right channels.

With up to seven main channels, plus a subwoofer, imaging becomes both more critical and more complex. The goal is to ensure that each channel is heard at the listening position with equal loudness.

EzSet/EQ calibration can handle this critical task for you, simply and automatically. However, the AVR's Level Adjust menu allows you to calibrate the levels manually, either using the system's test tone or while playing source material.

1. Make sure all speakers have been placed and connected correctly.
2. Adjust the number of speakers, crossover, distance and sub mode for each speaker in your system, as described in Step Three.
3. Measure the channel levels in one of these ways, and adjust the channel levels using the Level Adjust menu:
 - a) Preferably, use a handheld SPL meter set to the C-Weighting, Slow scale. Adjust each channel so that the meter reads 75dB.
 - b) By ear. Adjust the levels so that all channels sound equally loud.
 - c) If you are using a handheld SPL meter with source material, such as a test disc or an audio selection, play it and adjust the AVR's master volume control until the meter measures 75dB.

Press the OSD Button to display the Master menu, and then navigate to the MANUAL SETUP line. Press the OK Button to display the Manual Setup menu. Select the LEVEL ADJUST line and press the OK Button to display the Level Adjust menu. See Figure 30.



Figure 30 – Level Adjust Menu

All of the speaker channels will appear with their current level settings.

Channel Reset: To reset all of the levels to their factory defaults of 0dB, navigate to this line and change the setting to ON. The levels will be reset, and this setting will remain ON until one of the channel levels is adjusted.

If you are using an external source to set your output levels, navigate to each channel and use the ◀ ▶ Buttons to adjust the level as desired. If you would like to set your levels using the AVR 160's internal test tone, adjust the TEST TONE SEQ and TEST TONE lines as follows.

Test Tone SEQ: When this setting reads AUTO, the test tone will automatically circulate to all channels, pausing for a few moments at each channel for several seconds, as indicated by the blinking cursor. Adjust the level for any channel when the test tone is paused there by using the ◀ ▶ Buttons. You may also use the ▲ ▼ Buttons at any time to move the cursor to another line, and the test tone will follow the cursor.

When this setting reads MANUAL, the test tone will not move to the next channel until you use the ▲ ▼ Buttons.

Test Tone: This line determines whether the test tone is active. To begin the process of setting the levels, use the ◀ ▶ Buttons to change the setting to ON. Any time you manually move the cursor out of the channel listings area of the screen, this setting will automatically change to OFF, stopping the test tone.

Individual Channels: If you are using an external source to set your output levels, navigate to each channel and use the ◀ ▶ Buttons to adjust the level, between -10dB and +10dB. The level settings are global for all sources and surround modes.

When you have finished adjusting the speaker levels, select the BACK TO MANUAL SETUP option or press the OSD Button. Record the level settings in Table A6 in the appendix.

AUDIO SETTINGS

To adjust other audio settings, such as the tone controls, press the OSD Button to display the Master menu. With the cursor pointing to INPUT SETUP, press the OK Button to display the Input Setup menu, where the source, its title, its component video and audio inputs, and Auto Polling status may be adjusted, as described in the Initial Setup section. However, this section will focus on the four audio settings:

BXR: Enhances bass performance when playing MP3 tracks. Select On, or leave at the default Off setting for non-MP3 audio.

Tone: Determines whether the treble and bass controls are active. When it's OUT, the tone controls are “flat”, with no changes. When it's IN, the bass and treble frequencies are boosted or cut, depending upon the tone-control settings. When an analog audio source is in use and the 2-Channel Stereo surround mode is selected, setting the Tone Control to “OUT” places the unit in analog bypass mode.

Treble and Bass: Boost or cut the high or low frequencies by up to 10dB, 2dB at a time, by using the ◀ ▶ Buttons. The default setting is 0dB.

When you have finished, press the OSD Button.

ADVANCED REMOTE CONTROL FUNCTIONS

The remote control not only operates the AVR 160, but it also serves as a universal remote that may be programmed to operate many of your other home theater components, as described in the Installation section.

Each time you select one of your other components, the AVR remote switches to the control functions for that component. Since many buttons have unique functions for each component, refer to the Function List in Table A10 of the Appendix for assistance in operating your other components. Each button's function will not necessarily correspond to its label.

Punch-Through Programming

The AVR 160 remote's punch-through feature allows you to select one component for the remote to operate, while simultaneously setting certain groups of controls to operate another component. For example, while using the AVR to control surround modes and other audio functions, you may operate the transport controls of your DVD player. Or while using the remote to control video functions on your TV, you may use your cable box to change channels and the AVR to control the volume.

To program punch-through control while operating any device:

1. Press and hold the Input Selector (or AVR selector) for the main device the remote will be operating until the Program LED flashes and the remote enters Program mode.
2. Select the type of punch-through programming.
 - a) **Volume Control:** Press the Volume Up Button.
 - b) **Channel Control:** Press the Volume Down Button.
 - c) **Transport Control:** Press the Play Button.
3. Press the Input Selector (or AVR Selector) for the device whose volume, channel or transport controls you would like to be active while operating the device you selected in the first step. The LED will flash green to confirm the programming. For example, if you wish to watch your TV (programmed into the Video 3 Button) while changing channels using your cable box (Video 2), first press and hold the Video 3 Button until the LED flashes. Then press the Volume Down Button, followed by the Video 2 Button.

To undo punch-through programming, follow the same steps as above, but press the same Input (or AVR) Selector in Steps 1 and 3.

You may reassign the transport control punch-through programming for the AVR, VID2 and VID3 devices to other devices, such as CD. If you wish to remove transport control punch-through altogether for the AVR, VID2 or VID3 device, follow the same procedure as for programming punch-through, but in Step 3 press either of the other two of these three special selector buttons. For example, to remove punch-through transport control from the VID3 device so that pressing any of the transport controls will have no effect, press and hold the VID3 Button until the Program Indicator LED flashes in amber, then press the Play Button, followed by either the AVR or VID2 Button.

Macros

Macros are used to program sequences of up to 19 commands that are executed with a single button press. Macros are well suited for power on and off commands, or to send out a favorite multidigit channel number with one button press, or to have the ability to send out a code sequence to control a device while the remote is operating another device, but with more flexibility than the built-in punch-through controls.

Some commands may not be programmed into macros: Mute, Dim, or Channel Up/Down.

NOTE: Use caution when programming complicated macros. It isn't possible to program a pause or delay before sending commands after Power On, and the component may not be ready to respond to commands instantaneously after powering on.

To program, or "record", a macro, follow the steps below.

1. Simultaneously press one of the four Macro Buttons, or the Power On Button, and the Mute Button to enter program mode.
2. Press the Input (or AVR) Selector for each device before you enter commands to be transmitted to that device. This step counts as one of the 19 commands allowed for each macro.
3. For the Power On command, DO NOT press the Power On Button. Press the Mute Button instead.
4. Press the Power Off Button to program the Power Off command.
5. Press the Sleep Button to end the programming process.

To execute the macro, press the Macro Button, or the Power On Button, selected in the first step of programming the macro.

It isn't possible to "edit" a command within a macro. However, you may erase the macro as follows:

1. Simultaneously press and hold the Mute Button and the Macro Button containing the macro until the LED flashes.
2. Press the Channel Down Button to erase the macro.

Resetting the Remote

To reset the remote to its factory defaults, simultaneously press and hold any Input Selector and the "0" Numeric Key. When the Program LED flashes in amber, enter the code "333". When the green LED goes out, the remote will have been fully reset.

Appendix – Default settings

Table A1 – Recommended Source Component Connections

Device Type	AVR 160 Source	Audio Connections	Video Connections
VCR, DVR, PVR, TiVo or other audio/video recorder	Video 1	<ul style="list-style-type: none"> • Video 1 Analog (inputs and outputs) and • Any one available coaxial or optical digital audio input with corresponding coax digital output 	<ul style="list-style-type: none"> • <i>One of Component Video 2 or Video 1 Composite Video Input</i> • For recording, use Video 1 or Composite Video Output, and do not use component video connections at all
Cable TV, satellite TV, HDTV or other device that delivers television programs	Video 2	<ul style="list-style-type: none"> • Video 2 Analog Inputs and • Optical 1 Input (if not in use with HDMI 3) 	<ul style="list-style-type: none"> • <i>One of Component Video 2, or Video 2 Composite Video Input</i>
TV, game console, camera or other audio/video device	Video 3 (front-panel jacks)	<ul style="list-style-type: none"> • Video 3 Analog Inputs and • Either Coax 3 or Optical 3 Input 	<ul style="list-style-type: none"> • <i>One of Component Video 2, or Video 3 Composite Video Input</i>
DVD Audio/Video, SACD	DVD	<ul style="list-style-type: none"> • DVD Analog Inputs • 6-Channel Inputs (optional) and • Coax 1 Input 	<ul style="list-style-type: none"> • <i>One of Component Video 1, or DVD Composite Video Input</i>
HDMI-capable disc player or other audio/video device	HDMI 1	<ul style="list-style-type: none"> • HDMI 1 Input 	<ul style="list-style-type: none"> • HDMI 1 Input
HDMI-capable disc player or other audio/video device	HDMI 2	<ul style="list-style-type: none"> • HDMI 2 Input 	<ul style="list-style-type: none"> • HDMI 2 Input
HDMI-capable disc player or other audio/video device	HDMI 3	<ul style="list-style-type: none"> • HDMI 3 Input 	<ul style="list-style-type: none"> • HDMI 3 Input
Any audio device used with cable having 1/8" (3,5 mm) stereo audio mini plug	AUX	<ul style="list-style-type: none"> • AUX mini-jack input on rear panel 	<ul style="list-style-type: none"> • Not required
CD player	CD	<ul style="list-style-type: none"> • CD analog inputs and • Any one available coaxial or optical digital audio input 	<ul style="list-style-type: none"> • Not required
CD-R, miniDisc, cassette	Tape	<ul style="list-style-type: none"> • Tape Analog (inputs and outputs) and • Any one available coaxial or optical digital audio input • Use corresponding coax digital output 	<ul style="list-style-type: none"> • Not required

Note: The AVR 160 is equipped with a total of six digital audio inputs, four on the rear panel (Coaxial 1 and 2, Optical 1 and 2) and two on the front panel (Coaxial 3 and Optical 3), which may be assigned to any of the nine source inputs (DVD, Video 1 through 3, HDMI 1 through 3, CD and Tape). Certain digital audio connections are recommended simply because those digital audio inputs are assigned to those sources by default at the factory. But any digital audio input may be reassigned to any source. Since you may not be using all nine source inputs, you may reassign a digital audio input that is recommended for a source you aren't using to another device. Table A1 is a guideline; you may need to make adjustments to fit your system.

Table A2 – Source Setting Defaults

Source	DVD	HDMI 1	HDMI 2	HDMI 3	Video 1	Video 2	Video 3	AUX	CD	Tape	Tuner	6-/8-Channel
Title											INT. TUNER	
Component Video Input	COMP V 1				COMP V 2	COMP V 2	COMP V 2	COMP V 1	COMP V 1	COMP V 1	COMP V 1	COMP V 1
Audio Input	COAX 1	HDMI	HDMI	HDMI	ANALOG	OPTICAL 1	ANALOG		ANALOG	ANALOG		
Auto Poll	ON	OFF	OFF	OFF	OFF	ON	OFF		OFF	OFF	OFF	
Surround Mode	LOGIC 7 MOVIE	LOGIC 7 MOVIE	LOGIC 7 MOVIE	LOGIC 7 MOVIE	LOGIC 7 MOVIE	LOGIC 7 MOVIE	LOGIC 7 MOVIE	LOGIC 7 MOVIE	LOGIC 7 MOVIE	LOGIC 7 MOVIE	LOGIC 7 MOVIE	

Table A3 – Speaker/Channel Setting Defaults

Source	All Sources, Except 6-/8-Channel	6-/8-Channel
Left/Right Speaker	ON	LARGE
Center Speaker	ON	LARGE
Surround Speaker	ON	LARGE
Surround Back Speaker	ON	LARGE
Subwoofer	ON	SUB
Left/Right Speaker Crossover	100Hz	N/A
Center Speaker Crossover	100Hz	N/A
Surround Speaker Crossover	100Hz	N/A
Surround Back Speaker Crossover	100Hz	N/A
LFE	PRESENT	N/A
Sub Mode	SUB	SUB

Table A4 – Delay Setting Defaults

Speaker Position	Distance From Speaker to Listening Position	Your Delay Settings
Front Left	10 feet (3,0 m)	
Center	10 feet (3,0 m)	
Front Right	10 feet (3,0 m)	
Surround Right	10 feet (3,0 m)	
Surround Left	10 feet (3,0 m)	
Surround Back Right	10 feet (3,0 m)	
Surround Back Left	10 feet (3,0 m)	
Subwoofer	10 feet (3,0 m)	
A/V Sync Delay	0mS	

APPENDIX

Table A5 – Source Input Settings

Source	DVD	HDMI 1	HDMI 2	HDMI 3	Video 1	Video 2	Video 3	AUX	CD	Tape	Tuner	6-/8-Channel
Title											INT. TUNER	
Video Input												
Component Video Input												
Digital Audio Input								N/A			N/A	N/A
Analog Audio Input								AUX			TUNER	6-/8-CH
Auto Poll								N/A			N/A	N/A

Table A6 – Speaker/Channel Settings

Source	DVD	HDMI 1	HDMI 2	HDMI 3	Video 1	Video 2	Video 3	AUX	CD	Tape	Tuner	6-/8-Channel [†]
Left/Right Speaker												N/A
Center Speaker												N/A
Surround Speaker												N/A
Surround Back Speaker												N/A
Subwoofer												N/A
Left/Right Speaker Crossover												N/A
Center Speaker Crossover												N/A
Surround Speaker Crossover												N/A
Surround Back Speaker Crossover												N/A
LFE												N/A
Sub Mode												Sub
Left Channel Level												
Right Channel Level												
Center Channel Level												
Surround Left Channel Level												
Surround Right Channel Level												
Surround Back Left Channel Level												
Surround Back Right Channel Level												
Subwoofer Channel Level												

[†] The 6-channel inputs are "direct" inputs, meaning their signals are passed directly to the volume control without any bass management processing. Thus, the speaker sizes are always full-range, and it isn't possible to adjust speaker size crossover.

Table A7 – Remote Control Codes

Source Input	Product Type (circle one)	Remote Control Code
Video 1	VCR, PVR, DMC	
Video 2	Cable, Satellite	
Video 3	TV	
HDMI 1	DVD, Harman Kardon Blu-ray Disc	
HDMI 2	DVD, VCR/PVR/DMC, Cable/Satellite	
HDMI 3	DVD, VCR/PVR/DMC, Cable/Satellite	
DVD	DVD, Harman Kardon Blu-ray Disc	
CD	CD, CD-R	
Tape	Cassette	

Table A8 – System Settings

Feature	Default Setting	Your Setting
VFD Fade Time-Out	Off	
Volume Default	Off	
Default Vol Set	-25dB	
HDMI Audio to TV	Off	
Semi-OSD Time-Out	5 Seconds	
Full-OSD Time-Out	20 Seconds	

Table A9 – Surround Modes

Surround Mode	Description	Incoming Bitstream or Signal
Dolby Digital	Provides up to five separate main audio channels and a dedicated low-frequency effects (LFE) channel.	<ul style="list-style-type: none"> Dolby Digital 1/0/.0 or .1, 2/0/.0 or .1, 3/0/.0 or .1, 2/1/.0 or .1, 2/2/.0 or .1, 3/2/.0 or .1 Dolby Digital EX (played as 5.1) Dolby Digital Plus decoded and delivered via coax or optical connection
Dolby Digital EX	An expansion of Dolby Digital 5.1 that adds a surround back channel which may be played through one or two surround back speakers. May be manually selected when a non-EX Dolby Digital stream is detected.	<ul style="list-style-type: none"> Dolby Digital EX Dolby Digital 2/2/.0 or .1, 3/2/.0 or .1
Dolby Digital Plus	An enhanced version of Dolby Digital encoded more efficiently, Dolby Digital Plus has the capacity for additional discrete channels and for streaming audio from the Internet, all with enhanced audio quality. Source material may be delivered via an HDMI connection, or decoded to Dolby Digital or PCM and transmitted via S/P-DIF coaxial or optical digital audio.	<ul style="list-style-type: none"> Dolby Digital Plus via HDMI connection (source device decodes to Dolby Digital when a coax or optical connection is used)
Dolby TrueHD	Dolby TrueHD is an expansion of MLP Lossless™ audio, the same format used on DVD Audio discs. Dolby TrueHD adds the features found in Dolby Digital, such as night mode settings, while delivering fully lossless audio that is a true reproduction of the studio master recording.	<ul style="list-style-type: none"> Blu-ray Disc or HD-DVD encoded with Dolby TrueHD, delivered via HDMI
Dolby Digital Stereo	Delivers a 2-channel downmix of Dolby Digital materials.	<ul style="list-style-type: none"> Dolby Digital 1/0/.0 or .1, 2/0/.0 or .1, 3/0/.0 or .1, 2/1/.0 or .1, 2/2/.0 or .1, 3/2/.0 or .1 Dolby Digital EX
Dolby Pro Logic II Mode Group	Analog decoder that derives five full-range, discrete main audio channels from matrix surround-encoded or 2-channel analog sources. Four variants are available.	See below

APPENDIX

Surround Mode	Description	Incoming Bitstream or Signal
Dolby Pro Logic II Movie	Variant of Dolby Pro Logic II that is optimized for movie and television programs.	<ul style="list-style-type: none"> • Dolby Digital 2.0 or 2.1 • Analog (2-channel) • Tuner • PCM (32kHz, 44.1kHz, 48kHz, 96kHz)
Dolby Pro Logic II Music	Variant of Dolby Pro Logic II that is optimized for music selections. Allows adjustment of sound field presentation in three dimensions: <ul style="list-style-type: none"> • Center Width (adjusts width of vocal soundstage) • Dimension (adjusts depth of soundstage) • Panorama (adjusts wraparound surround effect) 	<ul style="list-style-type: none"> • Dolby Digital 2.0 or 2.1 • Analog (2-channel) • Tuner • PCM (32kHz, 44.1kHz, 48kHz, 96kHz)
Dolby Pro Logic II Game	Variant of Dolby Pro Logic II that emphasizes use of the surround channels and subwoofer for total immersion in the video gaming experience.	<ul style="list-style-type: none"> • Dolby Digital 2.0 or 2.1 • Analog (2-channel) • Tuner • PCM (32kHz, 44.1kHz, 48kHz, 96kHz)
Dolby Pro Logic	Original version of Dolby Pro Logic that steered a mono signal containing information below 7kHz to the surround channels.	<ul style="list-style-type: none"> • Dolby Digital 2.0 or 2.1 • Analog (2-channel) • Tuner • PCM (32kHz, 44.1kHz, 48kHz, 96kHz)
Dolby Pro Logic IIx Mode Group	An expansion of Dolby Pro Logic II that adds a surround back channel which may be played through one or two surround back speakers. The Dolby Pro Logic IIx modes may be selected not only with Dolby Digital bitstreams, but thanks to the AVR 160's post-processor, they may also be used with some DTS bitstreams to add a surround back channel to 5.1 modes.	See below
Dolby Pro Logic IIx Movie	This mode is similar to Dolby Pro Logic II Movie, with an added surround back channel.	<ul style="list-style-type: none"> • Dolby Digital 2/0/.0 or .1, 2/2/.0 or .1, 3/2/.0 or .1, EX • Analog (2-channel) • Tuner • PCM (32kHz, 44.1kHz, 48kHz, 96kHz)
Dolby Pro Logic IIx Music	This mode is similar to Dolby Pro Logic II Music, including the availability of center width, dimension and panorama adjustments. Dolby Pro Logic IIx Music adds a surround back channel.	<ul style="list-style-type: none"> • Dolby Digital 2/0/.0 or .1, 2/2/.0 or .1, 3/2/.0 or .1, EX • Analog (2-channel) • Tuner • PCM (32kHz, 44.1kHz, 48kHz, 96kHz)a
Dolby Pro Logic IIx Game	This mode is similar to Dolby Pro Logic II Game, with the added benefit of a surround back channel.	<ul style="list-style-type: none"> • Dolby Digital 2/0/.0 or .1 • Analog (2-channel) • Tuner • PCM (32kHz, 44.1kHz or 48kHz)
Harman Virtual Speaker	Simulates 5.1 channels when only two speakers are present, or a more enveloping sound field is desired.	<ul style="list-style-type: none"> • Dolby Digital • Analog (2-channel) • Tuner • PCM (32kHz, 44.1kHz or 48kHz)
DTS Digital	Using a different encoding/decoding method than Dolby Digital, it also provides up to five discrete main channels, plus an LFE channel.	<ul style="list-style-type: none"> • DTS 1/0/.0 or .1, 2/0/.0 or .1, 3/0/.0 or .1, 3/1/.0 or .1, 2/2/.0 or .1, 3/2/.0 or .1 • DTS-ES Matrix (played as 5.1) • DTS-ES Discrete (played as 5.1)
DTS-HD	DTS-HD is a new high-definition audio format that complements the high-definition video found on Blu-ray Disc and HD-DVD discs. It is transmitted using a DTS core with high-resolution extensions. Even when only DTS 5.1 surround sound is desired (or available, if the multizone system is in use), the higher capacity of high-resolution discs serves up DTS at twice the bit rate used on DVD-Video discs.	<ul style="list-style-type: none"> • Blu-ray Disc or HD-DVD discs encoded with DTS-HD modes, delivered via HDMI
DTS-HD Master Audio	DTS-HD Master Audio technology delivers bit-for-bit reproductions of the studio master recording in up to 7.1 channels, for an incredibly accurate performance.	<ul style="list-style-type: none"> • Blu-ray Disc or HD-DVD discs encoded with DTS-HD Master Audio technology, delivered via HDMI
DTS-ES Matrix	DTS Extended Surround adds a single surround back channel to DTS 5.1 digital surround sound. The Matrix version includes the surround back channel information "matrixed" into the left and right (side) surround channels, for compatibility with 5.1-channel systems.	<ul style="list-style-type: none"> • DTS-ES Matrix

Surround Mode	Description	Incoming Bitstream or Signal
DTS-ES Discrete	DTS-ES Discrete is another Extended Surround mode that adds a surround back channel, but this information is encoded discretely on the disc, and is not derived from information contained in the surround channels.	<ul style="list-style-type: none"> • DTS-ES Discrete
DTS Stereo	Delivers a 2-channel downmix of DTS Digital materials, or presents a matrix-encoded surround presentation.	<ul style="list-style-type: none"> • DTS 1/0/.0 or .1, 2/0/.0 or .1, 3/0/.0 or .1, 3/1/.0 or .1, 2/2/.0 or .1, 3/2/.0 or .1 • DTS 96/24 • DTS-ES Matrix • DTS-ES Discrete
DTS Neo:6 Mode Group	DTS Neo:6 analog processing is available with DTS and DTS 96/24 signals and 2-channel analog or PCM signals to create a 3-, 5- or 6-channel presentation.	See below
DTS Neo:6 Cinema	Depending on the number of speakers in your system, select 3-, 5- or 6-channel modes, enhanced for movie or video presentations.	<ul style="list-style-type: none"> • DTS 2/2/.0 or .1, 3/2/.0 or .1 • DTS 96/24 • Analog (2-channel) • PCM (32kHz, 44.1kHz or 48kHz)
DTS Neo:6 Music	Available only in 5- and 6-channel modes, creates a surround presentation suitable for music recordings.	<ul style="list-style-type: none"> • DTS 2/2/.0 or .1, 3/2/.0 or .1 • DTS 96/24 • Analog (2-channel) • PCM (32kHz, 44.1kHz or 48kHz)
Logic 7 Mode Group	A Harman International proprietary technology, Logic 7 technology enhances 2-channel and matrix-encoded recordings by deriving separate information for the surround back channels. This provides more accurate placement of sound, improves panning and expands the sound field, even when used with 5.1-channel systems. Logic 7 technology uses 96kHz processing, and is available in 5.1- or 7.1-channel modes. Three variants are available.	See below
Logic 7 Movie	Especially suited to 2-channel sources containing Dolby Surround or matrix encoding, Logic 7 Movie mode increases center channel intelligibility.	<ul style="list-style-type: none"> • Analog (2-channel) • Tuner • PCM (32kHz, 44.1kHz, 48kHz, 96kHz)
Logic 7 Music	The AVR 160 is programmed at the factory to default to this mode for 2-channel signals. Logic 7 Music mode is well suited to conventional 2-channel music recordings.	<ul style="list-style-type: none"> • Analog (2-channel) • Tuner • PCM (32kHz, 44.1kHz, 48kHz, 96kHz)
Logic 7 Game	Use Logic 7 Game mode to enhance enjoyment of video game consoles.	<ul style="list-style-type: none"> • Analog (2-channel) • Tuner • PCM (32kHz, 44.1kHz, 48kHz, 96kHz)
5-Channel Stereo	Useful for parties, the left- and right-channel information is played through both the front and surround speakers on each side, while the center speaker plays a summed mono mix.	<ul style="list-style-type: none"> • Analog (2-channel) • Tuner • PCM (32kHz, 44.1kHz or 48kHz, 96kHz, 192kHz)
7-Channel Stereo	Expands the 5-Channel Stereo presentation to include the surround back channels.	<ul style="list-style-type: none"> • Analog (2-channel) • Tuner • PCM (32kHz, 44.1kHz or 48kHz, 96kHz, 192kHz)
2-Channel Stereo	Turns off all surround processing and plays a pure 2-channel signal or a downmix of a multichannel signal. The signal is digitized and bass management settings are applied, making it appropriate when a subwoofer is used.	<ul style="list-style-type: none"> • Analog (2-channel; DSP downmix available for multichannel) • Tuner • PCM (32kHz, 44.1kHz, 48kHz, 96kHz)
2-Channel Stereo (Analog Bypass)	Maintains an analog input signal in that form, bypassing all digital processing (i.e., surround and bass management). Requires Tone Control setting to be off.	<ul style="list-style-type: none"> • Analog (2-channel) • Tuner

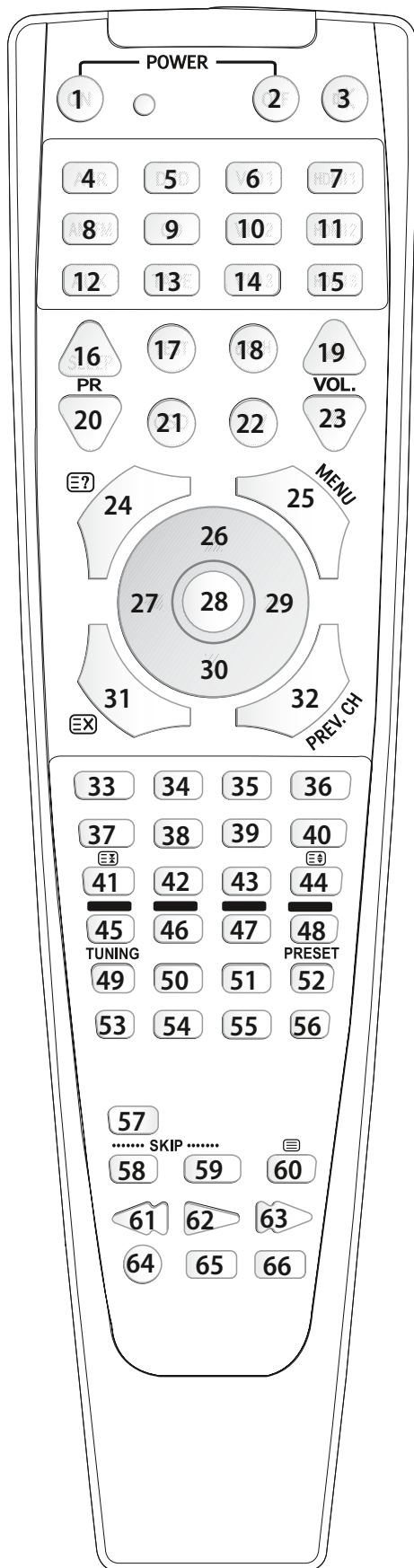

Figure 31 – Remote Control Function List Reference

Refer to the numbered buttons in this image when using the Function List.

Table A10 – Remote Control Function List

No.	Button Name	AVR	CD		
		AVR(001)	CD(001)	CD(002) CDR	CD(003)
01	Power On	Power On	Power On	Power On	Power On
02	Power Off	Power Off	Power Off	Power Off	Power Off
03	Mute	Mute	Mute(AVR)	Mute(AVR)	Mute(AVR)
04	AVR	AVR Power On	AVR Power On	AVR Power On	AVR Power On
05	DVD	DVD	DVD	DVD	DVD
06	VID1(VCR)	VID1	VID1	VID1	VID1
07	HDMI1	HDMI 1	HDMI 1	HDMI 1	HDMI 1
08	AM/FM	AM/FM	AM/FM	AM/FM	AM/FM
09	CD	CD	CD	CD	CD
10	VID2(CBL/SAT)	VID2	VID2	VID2	VID2
11	HDMI2	HDMI 2	HDMI 2	HDMI 2	HDMI 2
12	AUX	AUX	AUX	AUX	AUX
13	TAPE	TAPE	TAPE	TAPE	TAPE
14	VID3(TV)	VID3	VID3	VID3	VID3
15	HDMI3	HDMI3	HDMI3	HDMI3	HDMI3
16	Sleep/ PR+	Sleep			
17	Test Tone	Test Tone			
18	6/8 CH	6/8 CH	6/8 CH	6/8 CH	6/8 CH
19	Vol Up	Vol Up		Vol Up	
20	PR-			CDR Select	
21	OSD	OSD		Program	
22	T/V			Input Select	Source
23	Vol Down	Vol Down		Vol Down	
24	CH. /	Channel		Continuous Play	
25	Speaker / Menu	Speaker	Intro Scan	Intro Scan	Info
26	Level+/Up ▲	Level+/Up			
27	Left ◀	Left			
28	OK	OK			
29	Right ▶	Right			
30	Level-/Down ▼	Level-/Down			
31	Digital /	Digital			
32	Delay / Prev. CH	Delay	Open/Close	Open/Close	Open/Close
33	1	1	1	1	1
34	2	2	2	2	2
35	3	3	3	3	3
36	4	4	4	4	4
37	5	5	5	5	5
38	6	6	6	6	6
39	7	7	7	7	7
40	8	8	8	8	8
41	TUN-M /	TUN-M	Repeat	Repeat	Repeat
42	9	9	9	9	9
43	0	0	0	0	0
44	Memory /	Memory	Time	Time	Time
45	Tuning Up / RD	Tuning Up		Track Direct	Folder +
46	Direct / GR	Direct	Random Play	Random Play	Random
47	Clear / YL	Clear		Clear	Clear
48	Preset Up / BL	Preset Up	(+10)		(10+)
49	Tuning Down	Tuning Down		Track Increment	Folder -
50	Tone	Tone Mode		Program	
51	RDS	RDS	Disc Skip		
52	Preset Down	Preset Down			(10-)
53	M1	M1			
54	M2	M2			
55	M3	M3			
56	M4	M4			
57	Night	Night		CDP Select	
58	Skip Down	Skip Down(DVD)	Skip Down	Skip Down	Previous
59	Skip Up	Skip Up(DVD)	Skip Up	Skip Up	Next
60	DIM	Dimmer			Display
61	Rew(◀◀)	Rew(DVD)	R. Search	R. Search	Search -
62	Play(▶▶)	Play(DVD)	Play	Play	Play/Pause
63	FF(▶▶▶)	FF(DVD)	F. Search	F. Search	Search +
64	Record(●)	Repeat(DVD)		Record	
65	Stop(■)	Stop(DVD)	Stop	Stop	Stop
66	Pause(⏸)	Pause(DVD)	Pause	Pause	Play/Pause

Table A10 – Remote Control Function List continued

DVD			AUX	HDMI 1/2/3	VID1		VID2		VID3
Bluray(001)	DVD(002)	DVD(003)	AUX(001)	HDMI1/2/3	VCR	DMC 250/1000	CBL	SAT	TV
Power On	Power On	Power On		Power On	Power On	Power On	Power On	Power On	Power On
Power Off	Power Off	Power Off		Power Off	Power Off	Power Off	Power Off	Power Off	Power Off
Mute(AVR)	Mute(AVR)	Mute(AVR)		MUTE	MUTE		MUTE	MUTE	MUTE
AVR Power On	AVR Power On	AVR Power On	AVR Power On	AVR Power On	AVR Power On	AVR Power On	AVR Power On	AVR Power On	AVR Power On
DVD	DVD	DVD	DVD	DVD	DVD	DVD	DVD	DVD	DVD
VID1	VID1	VID1	VID1	VID1	VID1	VID1	VID1	VID1	VID1
HDMI 1	HDMI 1	HDMI 1	HDMI 1	HDMI 1	HDMI 1	HDMI 1	HDMI 1	HDMI 1	HDMI 1
AM/FM	AM/FM	AM/FM	AM/FM	AM/FM	AM/FM	AM/FM	AM/FM	AM/FM	AM/FM
CD	CD	CD	CD	CD	CD	CD	CD	CD	CD
VID2	VID2	VID2	VID2	VID2	VID2	VID2	VID2	VID2	VID2
HDMI 2	HDMI 2	HDMI 2	HDMI 2	HDMI 2	HDMI 2	HDMI 2	HDMI 2	HDMI 2	HDMI 2
AUX	AUX	AUX	AUX	AUX	AUX	AUX	AUX	AUX	AUX
TAPE	TAPE	TAPE	TAPE	TAPE	TAPE	TAPE	TAPE	TAPE	TAPE
VID3	VID3	VID3	VID3	VID3	VID3	VID3	VID3	VID3	VID3
HDMI3	HDMI3	HDMI3	HDMI3	HDMI3	HDMI3	HDMI3	HDMI3	HDMI3	HDMI3
		Audio		PR+	PR+	Audio	PR+	PR+	PR+
						Find			
6/8 CH	6/8 CH	6/8 CH	6/8 CH	6/8 CH	6/8 CH	6/8 CH	6/8 CH	6/8 CH	6/8 CH
Vol Up(AVR)	Vol Up			Vol Up	Vol Up		Vol Up	Vol Up	Vol Up
Disc Menu	Disc Menu	Title		PR-	PR-	Title	PR-	PR-	PR-
Subtitle	SUB On/Off	HD Mode		OSD	OSD	Info	OSD	OSD	OSD
Setup	V.OFF	V.OFF		TV/VCR	TV/VCR	Video Mode	TV/CBL	TV/SAT	TV/VCR
Vol Down(AVR)	Vol Down			Vol Down	Vol Down		Vol Down	Vol Down	Vol Down
Status	Title	Disc Menu		Guide		Disc Menu	INFO	INFO	
Popup/Title Menu	Menu	Setup		Menu	Menu	Setup	Menu	Menu	Menu
Up	Up	Up		Up	Up	Up	Up	Up	Up
Left	Left	Left		Left	Left	Left	Left	Left	Left
OK	Enter	Enter		Set/Enter	Enter	Enter	Enter	Enter	Enter
Right	Right	Right		Right	Right	Right	Right	Right	Right
Down	Down	Down		Down	Down	Down	Down	Down	Down
Open/Close	Open/Close	Open/Close				Open/Close			
Return	Return	Status		Prev. CH	-/--	Status	Prev. CH	Prev. CH	Prev. CH
1	1	1		1	1	1	1	1	1
2	2	2		2	2	2	2	2	2
3	3	3		3	3	3	3	3	3
4	4	4		4	4	4	4	4	4
5	5	5		5	5	5	5	5	5
6	6	6		6	6	6	6	6	6
7	7	7		7	7	7	7	7	7
8	8	8		8	8	8	8	8	8
Clear	Chapter	Zoom			Slow Down	Zoom		East	
9	9	9		9	9	9	9	9	9
0	0	0		0	0	0	0	0	0
Audio	Audio	Playlist			Slow Up	Source		West	
A/Red	Next. CHAP				Cancel	Return	PPV	Cancel	Red
B/Green	Angle	Angle		Angle/Fav		Angle	FAV	FAV	Green
C/Yellow	Clear	Clear			Clear	Clear	Bypass	Next	Yellow
D/Blue	Slow Up						Music	Alt	Blue
PIP	Prev. CHAP								Sleep
PIP Audio						V-Off			
Angle	Disc Skip	Disc Skip				Play Mode			
A-B	Slow Down					A-B			
Find	Subtitle On/Off	Subtitle				Subtitle			
Previous	Prev Step	Prev Step			Scan Down	Prev/step	Skip Down(DVD)	Skip Down(DVD)	Skip Down(DVD)
Next/Step	Next Step	Next Step			Scan Up	Next/step	Skip Up(DVD)	Skip Up(DVD)	Skip Up(DVD)
Dimmer		Dimmer				Dimmer			
Search ◀	REW	REW		REW	REW	Search/slow(rew)	REW(DVD)	REW(DVD)	REW(DVD)
Play	Play	Play		Play	Play	Play	Play(DVD)	Play(DVD)	Play(DVD)
Search ▶	FF	FF		FF	FF	Search/slow(ff)	FF(DVD)	FF(DVD)	FF(DVD)
Repeat				REC	REC	Record	Repeat(DVD)	Repeat(DVD)	Repeat(DVD)
Stop	Stop	Stop		Stop	Stop	Stop	Stop(DVD)	Stop(DVD)	Stop(DVD)
Pause	Pause	Pause		Pause	Pause	Pause	Pause(DVD)	Pause(DVD)	Pause(DVD)

Note: When any of the transport controls are pressed while the remote is in AVR, Video 2 or Video 3 mode, the remote will automatically switch to DVD mode and the command will be applied to the DVD player. If you then press a button native to the original mode, e.g., Volume Down for the AVR, the remote will revert to the original mode. See Punch-Through Programming, described in the Advanced Functions section, for more information.

SETUP CODE TABLES

Refer to Tables A11 through A17 when programming the codes for your components into the remote.

Table A11 – Remote Control Product Codes: TV

Manufacturer/Brand	Setup Code Number
ADMIRAL	192
ANAM	045 106 109 112 122
AOC	037 122 123 128
AUDIOVOX	012
BLAUPUNKT	084
BROKSONIC	205 206
CITIZEN	045 123 128 132
CONTEC	045
CRAIG	045 157 158 159
CROWN	045 132
CURTIS MATHES	123 128 132
DAEWOO	045 087 102 105 106 108 111 114 116 119 127 128 132
DAYTRON	128 132
DYNATECH	063
DYNEX	014
ELECTROHOME	115 132
EMERSON	045 123 128 132 139 157 158 159 162 205
Funai	045
FUJITSU	041 042
FUTURETECH	045
GE	029 087 121 123 128 133 145 159 163
GRUNDIG	193
HALL MARK	128
HARMAN KARDON	201
HITACHI	123 128 132 144 147
HYTEK	016
INKEL	120
JC PENNEY	115 123 128 132 145
JENSEN	019
JVC	079 087 134
KEC	045
KLH	006
KTV	045 123 132 162
LG/GOLDSTAR	002 013 101 110 122 128 132
LLOYTRON	172 173
LODGENET	069
LXI	077 145 148
MAGNAVOX	030 040 123 128 132 145 148
MARANTZ	115 123 148
MEMOREX	069 128
METZ	084
MGA	115 123 128
MITSUBISHI	077 115 123 128 160 167 168
MTC	175 176
NATIONAL	148 177 179 180 181 182
NEC	010 115 121 123 125
OLEVIA	007
OPTONICA	077
ORION	207 208 209 210 211
PANASONIC	087 148 169
PHILCO	045 115 123 128 132 148
PHILIPS	033 034 035 036 123 128 132 145 148
PIONEER	024 123 128
POLAROID	003 004 005 006 043
PORTLAND	128 132
PROSCAN	133
PROTON	008 059 122 128 132 165
QUASAR	032 087
RADIO SHACK	045 128 132 180 196 197
RCA	021 115 123 128 133 145 161 163
REALISTIC	045 167 196
RUNCO	044 046 152 153
SAMPO	059 123 128
SAMSUNG	020 022 124 128 132 145
SANYO	026 054
SCOTT	045 128 132
SEARS	128 132 145
SHARP	077 128 132
SIEMENS	084
SIGNATURE	069
SONY	028 031 117 130 136 194 212
SOUNDESIGN	045 128
SYLVANIA	025 123 128 145 148
SYMPHONIC	184
TANDY	077
TATUNG	063
TECHNICS	181
TECHWOOD	128
TEKNIKA	045 069 115 123 128 132
TELERENT	069
TERA	156
THOMSON	190 191
TIVO	051 052 and See Table A12
TMK	128
TOSHIBA	063 129 202
TOTEVISION	132
VIDEO CONCEPTS	160
VIDTECH	128
VIEWSONIC	011 038 039 047
VIZIO	001 002

WARDS	069 128 132 148
WESTINGHOUSE	017 018 023
YAMAHA	123 128
YORK	128
ZENITH	069 090

Table A12 – Remote Control Product Codes: VCR

Manufacturer/Brand	Setup Code Number
AIWA	040
AKAI	048 108 109 126
APPLE TV	016
AUDIO DYNAMICS	018 048
BROKSONIC	110 147
CANON	135 140
CAPEHART	094
CITIZEN	134
CRAIG	045 116
DAEWOO	017 094 104
DAYTRON	094
DBX	018 048
DYNATECH	040
EMERSON	013 040 042 110 112
FISHER	017
FUNAI	040
GE	076 095 124
HARMAN KARDON	002 003 018 049
HITACHI	040 048
JC PENNEY	018 045
JENSEN	048
JVC	018 048 111 132
KENWOOD	020 048
LG/GOLDSTAR	018 107
LLOYD	040
LXI	020 040
MAGNAVOX	040
MARANTZ	018
MEMOREX	017 020 040 052 053 054 076 142
MGA	049
MITSUBISHI	049 131
MULTITECH	040
NAD	139
NATIONAL	140
NEC	018 048
NORDMENDE	048
OPTIMUS	159
ORION	147
PANASONIC	125 150 167 172
PHILCO	040
PHILIPS	040 075
PORTLAND	094
PULSAR	076
QUASAR	001 125
RADIO SHACK	055 134 140 142 158 159
RCA	095 124 125 157 172
REALISTIC	017 020 040 045 159
SAMSUNG	045 051 095 105 109
SANSUI	048 116 147
SANYO	017 020
SCOTT	110 112
SEARS	017 020
SHARP	129 156
SONY	080 129
SOUNDESIGN	040
SYLVANIA	040
SYMPHONIC	040
TANDY	017 040
TEAC	040 048
TEKNIKA	040
THOMAS	040
Tivo	004 005 006 007 008 009 011 012
TMK	013
TOSHIBA	112 155
TOTEVISION	045
UNITECH	045
VECTOR RESEARCH	018
VIDEO CONCEPTS	018 040
VIDEOSONIC	045
WARDS	040 045 112
YAMAHA	018 040 048
ZENITH	040 050 076 083

Table A13 – Remote Control Product Codes: CD

Manufacturer/Brand	Setup Code Number
ADCOM	063 069
AIWA	072 111 118 156 170
AKAI	050 177 184
AUDIO TECHNICA	053
AUDIOACCESS	125
AUDIOFILE	211
BSR	044
CALIFORNIA AUDIO	109
CAPETRONIC	070
CARRERA	087
CARVER	136 140 141 143 144 145 185 186
CASIO	117 166
CLARINETTE	166

DENON	187 188 213
EMERSON	052 093 108
FISHER	055 095
FUNAI	126
GE	164
HAITAI	099 214
HARMAN KARDON	001 002 025 054 190
HITACHI	093
INKEL	216
JC PENNEY	098 147
JENSEN	153
JVC	176 195 196
KENWOOD	030 062 078 079 148 151 176 178 181
LG/GOLDSTAR	016 087
LOTTE	108
LUXMAN	077 102
LXI	164
MAGNAVOX	039 113
MARANTZ	058 084 191 192 193
MCINTOSH	194
MCS	080 098
MITSUMI	152
MODULAIRE	166
NAD	013 074 197 198
NAKAMICHI	199 200 201
NEC	069
NIKKO	053 055
ONKYO	037 038 045 046 171 175 202 203
OPTIMUS	065 089 091 092 099 104 212
PANASONIC	075 109 119 158 183 204
PHILIPS	039 138 149 209
PIONEER	071 094 100 112 123 131 161 162 215
PROTON	210
RADIO SHACK	126 166 213
RCA	024 081 093 150
REALISTIC	058 093 095 104 105 108 164 166
SANSUI	047 081 134 157 172
SANYO	033 082 095
SCOTT	108
SHARP	058 105 114 151 159 167 180 181
SHERWOOD	003 041 058 105 133
SONY	103 115 116 118 132 139 163 205 206 207 208 212 217
SOUNDSTREAM	124
SYMPHONIC	059 110
TAEKWANG	177
TEAC	011 058 085 086 106 107 110 121 137 146 154
THETA DIGITAL	039
TOSHIBA	013 074 097 151 155 173
VECTOR RESEARCH	087
VICTOR	120 130
WARDS	095
YAMAHA	019 031 053 061 135 169
YORK	166

Table A14 – Remote Control Product Codes: DVD

Manufacturer/Brand	Setup Code Number
APEX DIGITAL	061
DENON	019 020 051
GE	004 103
HARMAN KARDON	001 002 003
JVC	006
LG/GOLDSTAR	005 010 055 064 066
MAGNAVOX	056
MARANTZ	059
MITSUBISHI	023
NAD	062
ONKYO	009 048
PANASONIC	008 024 030 044
PHILIPS	016 056
PIONEER	018 027 041 065
PROCEED	060
PROSCAN	004 103
RCA	004 103
SAMSUNG	017 053 054
SHARP	028
SONY	011 012 015 043 045
THOMSON	004 103
TOSHIBA	009 058 067
YAMAHA	030 063
ZENITH	005 055 064

Table A15 – Remote Control Product Codes: SAT

Manufacturer/Brand	Setup Code Number
BIRDVIEW	425
CHANNEL MASTER	320 321 325 361
CHAPARRAL	315 316 451
CITOH	360
DIRECTV	309 310 314
DISH NETWORK	364
DRAKE	313 317 318 413 481
DX ANTENNA	331 352 379 483
ECHOSTAR	364 395 397 452 453 463 477 478 484 485
ELECTRO HOME	392
FUJITSU	324 329 334
GENERAL INSTRUMENT	303 311 323 365 403 454 468 474
HITACHI	304 455

HOUSTON TRACKER	463
HUGHES	305 306 437 489
JANIEL	366
JERROLD	454 468 484
LEGEND	453
MACOM	317 365 369 370 371
MAGNAVOX	461 473
MEMOREX	453
MITSUBISHI	307
MOTOROLA	312 319
NEXTWAVE	423
NORSAT	373
OPTIMUS	466
PACE	328 487
PANASONIC	353 366 457 469
PANSAT	420
PERSONAL CABLE	418
PHILIPS	375
PICO	407
PRESIDENT	381 404
RCA	301 358 439 458 465 490
REALISTIC	349 480
SAMSUNG	322 326 442
SATELLITE SERVICE CO	335 388
SCIENTIFIC ATLANTA	339 356
SONY	362 405
STAR CHOICE DBS	459
STARCAST	347
SUPERGUIDE	327 423
TELECOM	330 333 390 391 393 409
TOSHIBA	302 426 460 461 462 470
UNIDEN	323 332 348 349 350 351 354 355 381 383 389 403 466 479 480
ZENITH	359 384 385 387 394 419 488

Table A16 – Remote Control Product Codes: Tape

Manufacturer/Brand	Setup Code Number
MICROSOFT (XBOX)	001

Table A17 – Remote Control Product Codes: Cable

Manufacturer/Brand	Setup Code Number
ABC	001 011
ALLEGRO	111
AMERICAST	212
ARCHER	112
BELCOR	113
CABLE STAR	033 113
CITIZEN	111
COMCAST	007
DIGI LINK	114
EAGLE	186
EASTERN	066 070
EMERSON	112
GENERAL INSTRUMENT	001 011 017 096 097 210
GC ELECTRONICS	113
GEMINI	032 060
HAMLIN	056 099 100 101 117 175 208
HITACHI	001 188
JASCO	111
JERROLD	001 002 011 017 073 096 097 162 188 210
LINSAY	118
MACOM	191
MAGNAVOX	017 019 068
MOVETIME	035 039
NSC	035 190
OAK	197 220
PACE	179
PANASONIC	053 176 177 189 214
PANTHER	114
PHILIPS	013 019 020 085 090
PIONEER	001 041 119 171 209 215 216
RADIO SHACK	111 112 213
RCA	053 214
RECOTON	116
REGAL	056 099 100 101 208
REMBRANDT	032
SAMSUNG	003 072 186
SCIENTIFIC ATLANTA	183 203 221 222
SEAM	121
SIGNATURE	001 188
SPRUCER	053 081 177 189
STARCOM	002 011 163
STARGATE	120
TANDY	024
TELECAPATION	028
TEXSCAN	036
TFC	122
TIVO	029 030 and See Table A12
TOCOM	170 205
UNITED CABLE	011
UNIVERSAL	033 034 039 042 113
VIDEOWAY	124 211
VIEWSTAR	019 025 053 086 089 190
ZENITH	065 125 211 219

TROUBLESHOOTING GUIDE

SYMPTOM	CAUSE	SOLUTION
Unit does not function when Main Power Switch is turned on	<ul style="list-style-type: none">• No AC Power	<ul style="list-style-type: none">• Make certain AC power cord is plugged into a live outlet• Check whether outlet is switch-controlled
Display lights, but no sound or picture	<ul style="list-style-type: none">• Intermittent input connections• Mute is on• Volume control is down	<ul style="list-style-type: none">• Secure all input and speaker connections• Press Mute Button• Turn up volume control
No sound from any speaker; PROTECT message appears on front panel	<ul style="list-style-type: none">• Amplifier is in protection mode due to possible short• Amplifier is in protection mode due to internal problems	<ul style="list-style-type: none">• Check speaker wires for shorts at receiver and speaker ends• Contact your local Harman Kardon service center
No sound from surround or center speakers	<ul style="list-style-type: none">• Incorrect surround mode• Input is monaural• Incorrect configuration• Stereo or Mono program material	<ul style="list-style-type: none">• Select a mode other than Stereo• There is no surround information from mono sources• Check speaker configuration• The surround decoder may not create center- or rear-channel information from nonencoded programs
Unit does not respond to remote commands	<ul style="list-style-type: none">• Weak batteries in remote• Wrong device selected• Remote sensor is obscured	<ul style="list-style-type: none">• Change remote batteries• Press the AVR Settings Button• Make certain front-panel sensor is in line of sight of remote or connect an optional remote sensor
Intermittent buzzing in tuner	<ul style="list-style-type: none">• Local interference	<ul style="list-style-type: none">• Move unit or antenna away from computers, fluorescent lights, motors or other electrical appliances

Additional information on troubleshooting possible problems with your AVR 160, or installation-related issues, may be found in the list of "Frequently Asked Questions", which is located in the Product Support section at www.harmankardon.com.

PROCESSOR RESET

If the unit behaves erratically after a power surge, first turn off the Main Power Switch and unplug the AC power cord for at least 3 minutes. Plug the cord back in and turn the receiver on. If this doesn't help, reset the AVR.

NOTE: A system reset erases all user configurations, including video resolution, speaker and level settings, and tuner presets. After a reset, reenter all of these settings from your notes in the appendix worksheets.

To reset the AVR 160, place it in Standby mode (press the front-panel Standby/On Switch so that the Power Indicator turns amber). Then press the front-panel Surr. Mode Button until the RESET message appears.

If the receiver does not function correctly after a processor reset, contact an authorized Harman Kardon service center for assistance. Authorized service centers may be located by visiting the Web site at www.harmankardon.com.

MEMORY

If the AVR 160 is unplugged or experiences a power outage, it will retain user settings for up to two weeks.

Audio Section

Stereo Mode, Continuous Average Power (FTC)
40 Watts per channel, 20Hz–20kHz, @ <0.07% THD, both channels driven into 8 ohms

Seven-Channel Surround Modes
Power per Individual Channel

Front L & R channels:
40 Watts per channel @ <0.07% THD, 20Hz–20kHz into 8 ohms

Center channel:
40 Watts @ <0.07% THD, 20Hz–20kHz into 8 ohms

Surround (L & R Side, L & R Back) channels:
40 Watts per channel @ <0.07% THD, 20Hz–20kHz into 8 ohms

110 Watts per channel into 6 ohms @1kHz, <1% THD, one channel driven.

Input Sensitivity/Impedance

Linear (High-Level)	200mV/47k ohms
---------------------	----------------

Signal-to-Noise Ratio (IHF-A) 100dB

Surround System Adjacent Channel Separation

Pro logic® II	40dB
Dolby® Digital (AC-3)	55dB
DTS®	55dB

Frequency Response

@ 1W (+0dB, -3dB)	10Hz –130kHz
-------------------	--------------

High Instantaneous Current Capability (HCC) ±25 Amps

Transient Intermodulation Distortion (TIM) Unmeasurable

Slew Rate 40V/μsec

FM Tuner Section

Frequency Range	87.5–108.0MHz
Usable Sensitivity	IHF 1.3μV/13.2dBf
Signal-to-Noise Ratio	Mono/Stereo 70/68dB
Distortion	Mono/Stereo 0.2/0.3%
Stereo Separation	40dB @ 1kHz
Selectivity	±400kHz, 70dB
Image Rejection	80dB
IF Rejection	90dB

AM Tuner Section

Frequency Range	520-1710 kHz
Signal-to-Noise Ratio	45dB
Usable Sensitivity	Loop 500μV
Distortion	1kHz, 50% Mod 0.8%
Selectivity	±10kHz, 30dB

Video Section

Television Format	PAL/NTSC
Input Level/Impedance	1Vp-p/75 ohms
Output Level/Impedance	1Vp-p/75 ohms
Video Frequency Response (Composite)	10Hz–8MHz (–3dB)
Video Frequency Response (Component Video)	10Hz–100MHz (–3dB)
HDMI™	Version 1.3a with 10-bit Deep Color

General

Power Requirement	230-240V, 50/60Hz	
Power Consumption	540W maximum (7 channels driven)	
Stand-by consumption	<1W	
Dimensions	(Product)	(Shipping)
Width	440mm	555mm
Height	165mm	266mm
Depth	382mm	465mm
Weight	(Product)	(Shipping)
	9.1kg	10.9kg

Depth measurement includes knobs, buttons and terminal connections.

Height measurement includes feet and chassis.

Features, specifications and appearance are subject to change without notice.

Harman Kardon and Logic 7 are trademarks of Harman International Industries, Incorporated, registered in the United States and/or other countries. EzSet/EQ, Designed to Entertain and The Bridge II logo are trademarks of Harman International Industries, Incorporated. Blu-ray Disc is a trademark of the Blu-ray Disc Association.

CEA is a registered trademark of the Consumer Electronics Association.

Manufactured under license from Dolby Laboratories. Dolby, Pro Logic, and the double-D symbol are registered trademarks of Dolby Laboratories. MLP Lossless is a trademark of Dolby Laboratories.

Manufactured under license under U.S. Patent #'s 5,451,942; 5,956,674; 5,974,380; 5,978,762; 6,226,616; 6,487,535; 7,212,872; 7,333,929; 7,392,195; 7,272,567 and other U.S. and worldwide patents issued and pending. DTS is a registered trademark and the DTS logos, Symbol, DTS-HD and DTS-HD Master Audio are trademarks of DTS, Inc. © 1996-2008 DTS, Inc. All Rights Reserved.

Faroudja DCDi Cinema is a trademark of Genesis Microchip Inc.

HD-DVD is a trademark of the DVD Format/Logo Licensing Corporation (DVD FLLC).

HDMI, the HDMI logo and High-Definition Multimedia Interface are trademarks or registered trademarks of HDMI Licensing LLC.

iPod is a trademark of Apple Inc., registered in the U.S. and other countries.

SACD is a trademark of Sony Corporation.

TiVo is a registered trademark of TiVo Inc.

Please register your AVR 160 at www.harmankardon.com.

NOTE: You'll need the product's serial number. At the same time, you can choose to be notified about new products and/or special promotions.

harman/kardon®
Designed to Entertain™

H Harman International

8500 Balboa Blvd., Northridge, CA 91329
www.harmankardon.com

© 2009 Harman International Industries, Incorporated.

All rights reserved.

Part No. CQX1A1432Z

Free Manuals Download Website

<http://myh66.com>

<http://usermanuals.us>

<http://www.somanuals.com>

<http://www.4manuals.cc>

<http://www.manual-lib.com>

<http://www.404manual.com>

<http://www.luxmanual.com>

<http://aubethermostatmanual.com>

Golf course search by state

<http://golfingnear.com>

Email search by domain

<http://emailbydomain.com>

Auto manuals search

<http://auto.somanuals.com>

TV manuals search

<http://tv.somanuals.com>