

harman/kardon®
Power for the Digital Revolution.®

AVR 225

AUDIO/VIDEO RECEIVER
OWNER'S MANUAL

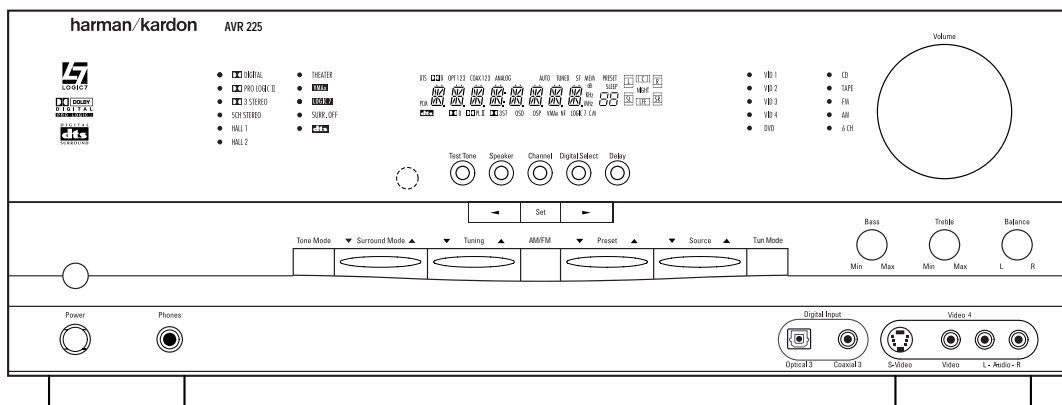

3	Introduction
4	Safety Information
4	Unpacking
5	Front-Panel Controls
7	Front-Panel Information Display
9	Rear-Panel Connections
11	Remote Control Functions
14	Installation and Connections
16	System Configuration
16	Speaker Selection and Placement
16	System Setup
17	Using the On-Screen Display To Make Configuration Adjustments
17	Setting the System Configuration Memories
17	Input Setup
18	Surround Setup
18	Delay Settings
19	Night Mode Settings
19	Speaker Setup
21	Configuring the Surround Off (Stereo) Modes
21	Stereo-Direct (Bypass) Mode
21	Stereo-Digital Mode
21	Output Level Adjustment
21	Using EzSet
22	Manual Output Level Adjustment
22	Additional Input Adjustments
24	Operation
24	Basic Operation
24	Source Selection
25	Surround Mode Chart
26	Surround Mode Selection
26	Digital Audio Playback
26	Selecting a Digital Source
27	Digital Status Indicators
27	Night Mode
28	Tuner Operation
28	Tape Recording
29	Output Level Trim Adjustment
29	6-Channel Direct Input
30	Advanced Features
30	Display Brightness
30	Turn-On Volume Level
30	Semi-OSD Settings
31	Full-OSD Time Out Adjustment
32	Programming the Remote
32	Direct Code Entry
32	Auto Search Method
32	Code Readout
33	Macro Programming
33	Programmed Device Functions
33	Punch-Through Programming
34	Volume Punch-Through
34	Channel Control Punch-Through
34	Transport Control Punch-Through
34	Resetting the Remote Memory
36	Function List
38	Setup Code Tables
48	Troubleshooting Guide
48	Processor Reset
49	Technical Specifications
50	Notes

Typographical Conventions

In order to help you use this manual with the remote control, front-panel controls and rear-panel connections, certain conventions have been used.

EXAMPLE – (bold type) indicates a specific remote control or front-panel button, or rear-panel connection jack

EXAMPLE – (OCR type) indicates a message that is visible on the front-panel information display

1 – (number in a square) indicates a specific front-panel control

1 – (number in a circle) indicates a rear-panel connection

1 – (number in an oval) indicates a button or indicator on the remote

A – (letter in a square) indicates an indicator in the front-panel information display

Thank you for choosing Harman Kardon®! With the purchase of a Harman Kardon AVR 225 you are about to begin many years of listening enjoyment. The AVR 225 has been custom-designed to provide all the excitement and detail of movie soundtracks and every nuance of musical selections. Onboard Dolby®** Digital and DTS®** decoding allows you to take advantage of the digital soundtracks from the latest DVD releases and Digital Television broadcasts.

While complex digital systems are hard at work within the AVR 225 to make all of this happen, hookup and operation are simple. Color-keyed connections, a programmable remote control, and on-screen menus make the AVR 225 easy to use. To obtain the maximum enjoyment from your new receiver, we urge you to take a few minutes to read through this manual. This will ensure that connections to speakers, source playback units and other external devices are made properly. In addition, a few minutes spent learning the functions of the various controls will enable you to take advantage of all the power the AVR 225 is able to deliver.

If you have any questions about this product, its installation or its operation, please contact your retailer or custom installer. They are your best local sources of information.

TO THE USER

This equipment has been tested and found to comply with the limits for a Class B digital device, pursuant to Part 15 of the FCC Rules. These limits are designed to provide reasonable protection against interference in a residential area. This device generates and uses radio frequency energy and if not installed and used in accordance with the instructions, it may cause interference to radio or TV reception.

If this unit does cause interference with TV or radio reception, you can try to correct the interference by one or more of the following measures:

- A. Reorient or relocate the receiving antenna.
- B. Increase the separation between the equipment and the receiver.
- C. Plug the equipment into a different outlet so that it is not on the same circuit as the receiver.

If necessary, consult the dealer or an experienced radio/TV technician for additional suggestions.

CAUTION:

Changes or modifications to this equipment not expressly approved by **harman consumer group** for compliance could void the user's authority to operate this equipment.

Description and Features

The AVR 225 is among the most versatile and multi-featured A/V receivers available, incorporating a wide range of listening options. In addition to Dolby Digital and DTS decoding for digital sources, a broad choice of analog surround modes are available for use with sources such as CD, VCR, TV broadcasts and the AVR 225's own FM/AM tuner. Along with the latest Dolby Pro Logic®** II decoding technology, Dolby 3 Stereo and custom Hall and Theater modes, only Harman Kardon receivers offer Logic 7®** to create a wider, more enveloping field environment and more defined fly-overs and pans. Another Harman Kardon exclusive is VMaX®**, which uses proprietary processing to create an open, spacious sound field even when only two front speakers are available. A Stereo-Direct mode bypasses the digital processor to preserve all of the subtleties of older analog, two-channel materials, while bass management improves your ability to tailor the sound to suit your room acoustics or taste.

In addition to providing a wide range of listening options, the AVR 225 is easy to configure so that it provides the best results with your speakers and specific listening-room environment. On-screen menus make it simple to enter settings for speakers, inputs and delay times, while our exclusive EzSet™** remote measures the system's sound levels and automatically calibrates them for a perfectly balanced sound field presentation.

For the ultimate in flexibility, the AVR 225 features connections for five video devices, all with both composite and S-Video inputs, including the front-panel inputs. Two additional audio inputs are available, and a total of six digital inputs make the AVR 225 capable of handling all the latest digital audio sources. Coax and optical digital outputs are also available for direct connection to digital recorders. Two video recording outputs and a six-channel input make the AVR 225 virtually future-proof, with everything needed to accommodate tomorrow's new formats right onboard. The AVR 225's powerful amplifier uses traditional Harman Kardon high-current, ultrawide-bandwidth design technologies.

Pour le CANADA

CORDE DE CONNEXION CA ATTENTION:
POUR ÉVITER LES CHOCS ÉLECTRIQUES, INTRODUIRE LA LAME LA PLUS LARGE DE LA FICHE DANS LA BORNE CORRESPONDANTE DE LA PRISE ET POUSSER JUSQU'AU FOND.

For CANADA

AC POWER CORD CONNECTION CAUTION:
TO PREVENT ELECTRIC SHOCK, MATCH WIDE BLADE OF PLUG TO WIDE SLOT, FULLY INSERT.

Harman Kardon invented the high-fidelity receiver almost fifty years ago. With state-of-the-art circuitry and time-honored circuit designs, the AVR 225 is one of the finest receivers ever offered by Harman Kardon.

- Onboard Dolby®** Digital and DTS®** Decoding Using Crystal®** Chip Technology
- Harman Kardon's Exclusive Logic 7®** and VMaX®** Modes
- Dolby Laboratories' Latest Pro Logic®** II Decoding Technology
- EzSet™** Remote Automatically Sets Output Levels for Optimum Performance
- Stereo-Direct Mode for Two-Channel Sources Bypasses DSP Processing To Preserve the Integrity of Analog Materials
- Stereo-Direct Mode for Programmable Bass Management of Low Frequencies Between Main Speakers and Subwoofer
- Front-Panel Digital Inputs for Easy Connection to Portable Digital Devices and the Latest Video Game Consoles
- Multiple Digital Inputs and Outputs
- On-Screen Menu and Display System
- 6-Channel Direct Input for Use With DVD-Audio Players, Other Products With Internal Surround Decoders or External Surround Decoders
- Color-Coded Input, Output and Speaker Terminals Comply With the Latest CEA Standards for Easy Installation



CAUTION

RISK OF ELECTRIC SHOCK
DO NOT OPEN



CAUTION: To reduce the risk of electric shock, do not remove cover (or back). No user-serviceable parts inside. Refer servicing to qualified service personnel.



The lightning flash with arrowhead symbol, within an equilateral triangle, is intended to alert the user to the presence of uninsulated "dangerous voltage" within the product's enclosure that may be of sufficient magnitude to constitute a risk of electric shock to persons.



The exclamation point within an equilateral triangle is intended to alert the user to the presence of important operating and maintenance (servicing) instructions in the literature accompanying the appliance.

SAFETY INFORMATION

Important Safety Information

Verify Line Voltage Before Use

Your AVR 225 has been designed for use with 120-volt AC current. Connection to a line voltage other than that for which it is intended can create a safety and fire hazard and may damage the unit.

If you have any questions about the voltage requirements for your specific model, or about the line voltage in your area, contact your selling dealer before plugging the unit into a wall outlet.

Do Not Use Extension Cords

To avoid safety hazards, use only the power cord attached to your unit. We do not recommend that extension cords be used with this product. As with all electrical devices, do not run power cords under rugs or carpets or place heavy objects on them. Damaged power cords should be replaced immediately by an authorized service center with a cord meeting factory specifications.

Handle the AC Power Cord Gently

When disconnecting the power cord from an AC outlet, always pull the plug, never pull the cord. If you do not intend to use the unit for any considerable length of time, disconnect the plug from the AC outlet.

Do Not Open the Cabinet

There are no user-serviceable components inside this product. Opening the cabinet may present a shock hazard, and any modification to the product will void your guarantee. If water or any metal object such as a paper clip, wire or a staple accidentally falls inside the unit, disconnect it from the AC power source immediately, and consult an authorized service station.

CATV or Antenna Grounding

If an outside antenna or cable system is connected to this product, be certain that it is grounded so as to provide some protection against voltage surges and static charges. Section 810 of the National Electrical Code, ANSI/NFPA No. 70-1984, provides information with respect to proper grounding of the mast and supporting structure, grounding of the lead-in wire to an antenna discharge unit, size of grounding conductors, location of antenna discharge unit, connection to grounding electrodes and requirements of the grounding electrode.

NOTE TO CATV SYSTEM INSTALLER: This reminder is provided to call the CATV (Cable TV) system installer's attention to article 820-40 of the NEC that provides guidelines for proper grounding and, in particular, specifies that the cable ground shall be connected to the grounding system of the building, as close to the point of cable entry as possible.

Installation Location

■ To ensure proper operation and to avoid the potential for safety hazards, place the unit on a firm and level surface. When placing the unit on a shelf, be certain that the shelf and any mounting hardware can support the weight of the product.

■ Make certain that proper space is provided both above and below the unit for ventilation. If this product will be installed in a cabinet or other enclosed area, make certain that there is sufficient air movement within the cabinet. Under some circumstances a fan may be required.

■ Do not place the unit directly on a carpeted surface.

■ Avoid installation in extremely hot or cold locations, or an area that is exposed to direct sunlight or heating equipment.

■ Avoid moist or humid locations.

■ Do not obstruct the ventilation slots on the top of the unit, or place objects directly over them.

Cleaning

When the unit gets dirty, wipe it with a clean, soft, dry cloth. If necessary, wipe it with a soft cloth dampened with mild soapy water, then a fresh cloth with clean water. Wipe dry immediately with a dry cloth. NEVER use benzene, aerosol cleaners, thinner, alcohol or any other volatile cleaning agent. Do not use abrasive cleaners, as they may damage the finish of metal parts. Avoid spraying insecticide near the unit.

Moving the Unit

Before moving the unit, be certain to disconnect any interconnection cords with other components, and make certain that you disconnect the unit from the AC outlet.

Important Information for the User

This equipment has been tested and found to comply with the limits for a Class-B digital device, pursuant to Part 15 of the FCC Rules. The limits are designed to provide reasonable protection against harmful interference in a residential installation. This equipment generates, uses and can radiate radio-frequency energy and, if not installed and used in accordance with the instructions, may cause harmful interference to radio communication. However, there is no guarantee that harmful interference will not occur in a particular installation. If this equipment does cause harmful interference to radio or television reception, which can be determined by turning the equipment off and on, the user is encouraged to try to correct the interference by one or more of the following measures:

■ Reorient or relocate the receiving antenna.

■ Increase the separation between the equipment and receiver.

■ Connect the equipment into an outlet on a circuit different from that to which the receiver is connected.

■ Consult the dealer or an experienced radio/TV technician for help.

This device complies with Part 15 of the FCC Rules. Operation is subject to the following two conditions: (1) this device may not cause harmful interference, and (2) this device must accept interference received, including interference that may cause undesired operation.

NOTE: Changes or modifications may cause this unit to fail to comply with Part 15 of the FCC Rules and may void the user's authority to operate the equipment.

Unpacking

The carton and shipping materials used to protect your new receiver during shipment were specially designed to cushion it from shock and vibration. We suggest that you save the carton and packing materials for use in shipping if you move, or should the unit ever need repair.

To minimize the size of the carton in storage, you may wish to flatten it. This is done by carefully slitting the tape seams on the bottom and collapsing the carton. Other cardboard inserts may be stored in the same manner. Packing materials that cannot be collapsed should be saved along with the carton in a plastic bag.

If you do not wish to save the packaging materials, please note that the carton and other sections of the shipping protection are recyclable. Please respect the environment and discard those materials at a local recycling center.

At this time you should remove the protective plastic film from the front-panel lens. Leaving the film in place may affect the performance of your remote control.

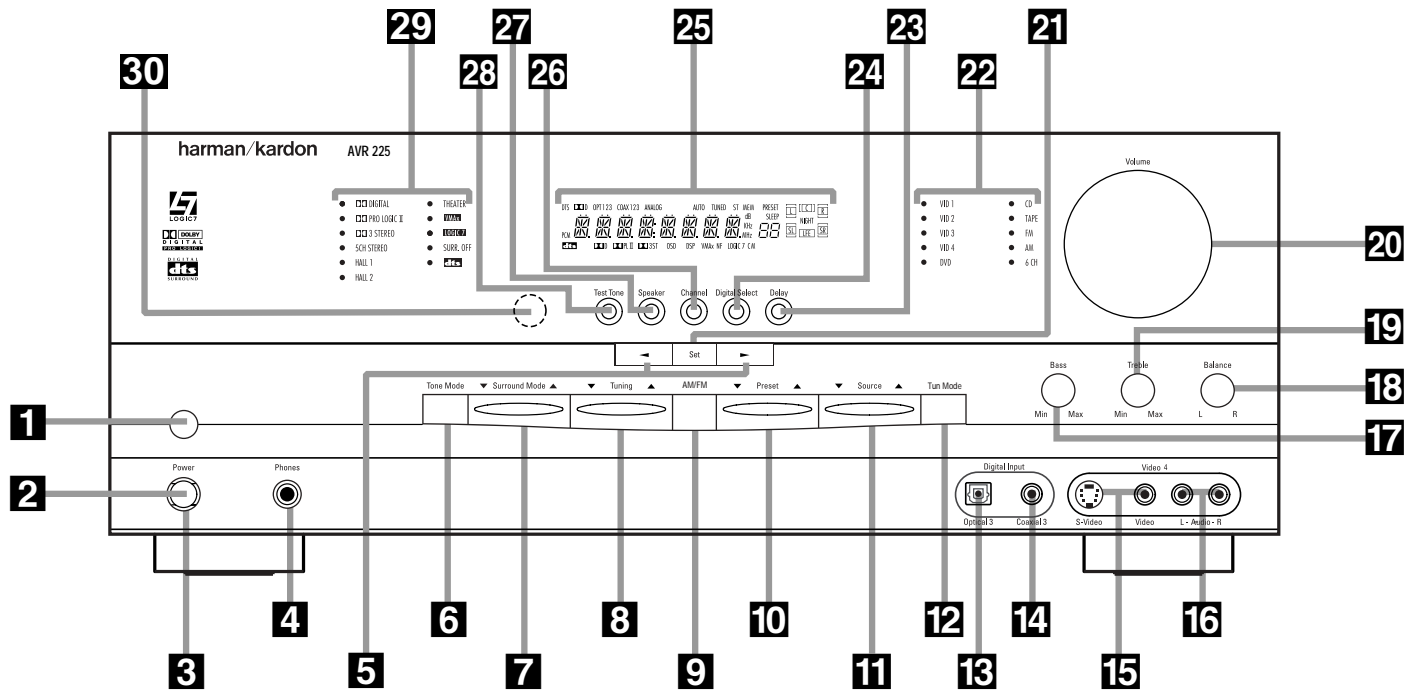

- | | | |
|--|---|--|
| <p>1 Main Power Switch</p> <p>2 System Power Control</p> <p>3 Power Indicator</p> <p>4 Headphone Jack</p> <p>5 Selector Buttons</p> <p>6 Tone Mode</p> <p>7 Surround Mode Selector</p> <p>8 Tuning Selector</p> <p>9 AM/FM Selector</p> <p>10 Preset Stations Selector</p> | <p>11 Input Source Selector</p> <p>12 Tuning Mode Selector</p> <p>13 Digital Optical 3 Input</p> <p>14 Digital Coax 3 Jack</p> <p>15 Video 4 Video Input Jacks</p> <p>16 Video 4 Audio Input Jacks</p> <p>17 Bass Control</p> <p>18 Balance Control</p> <p>19 Treble Control</p> <p>20 Volume Control</p> | <p>21 Set Button</p> <p>22 Input Indicators</p> <p>23 Delay</p> <p>24 Digital Input Selector</p> <p>25 Main Information Display</p> <p>26 Channel Select Button</p> <p>27 Speaker Select Button</p> <p>28 Test Tone Selector</p> <p>29 Surround Mode Indicators</p> <p>30 Remote Sensor Window</p> |
|--|---|--|

1 Main Power Switch: Press this button to apply power to the AVR 225. When the switch is pressed in, the unit is placed in a Standby mode, as indicated by the amber LED **3** surrounding the **System Power Control** **2**. This button **MUST** be pressed in to operate the unit. To turn the unit off and prevent the use of the remote control, this switch should be pressed until it pops out from the front panel so that the word "OFF" may be read at the top of the switch.

NOTE: This switch is normally left in the "ON" position.

2 System Power Control: When the **Main Power Switch** **1** is "ON," press this button to turn on the AVR 225; press it again to turn the unit off. Note that the **Power Indicator** **3** surrounding the switch will turn green when the unit is on.

3 Power Indicator: This LED will be illuminated in amber when the unit is in the Standby mode to signal that the unit is ready to be turned on. When the unit is in operation, the indicator will turn green. Should the indicator turn red, turn the unit off using the **Main Power Switch** **1** and check the speaker wire connections to make certain that there are no short circuits.

4 Headphone Jack: This jack may be used to listen to the AVR 225's output through a pair of headphones. Be certain that the headphones have a standard 1/4" stereo phone plug. Note that the main room speakers will automatically be turned off when the headphone jack is in use.

5 Selector Buttons: When you are establishing the AVR 225's configuration settings, use these buttons to

select from the choices available, as shown in the **Main Information Display** **25**.

6 Tone Mode: Pressing this button enables or disables the Bass and Treble tone controls. When the button is pressed so that the words **TONE IN** appear in the **Main Information Display** **25**, the settings of the **Bass** **17** and **Treble** **19** controls may be used to adjust the output signals. When the button is pressed so that the words **TONE OUT** appear in the **Main Information Display** **25**, the output signal will be "flat," without any bass or treble alteration, no matter how the actual **Bass** and **Treble Controls** **17/19** are adjusted.

7 Surround Mode Selector: Press this button to change the surround mode by scrolling through the list of available modes. Note that depending on the type

FRONT - PANEL CONTROLS

of input, some modes are not always available. (See page 25 for more information about surround modes.)

8 Tuning Selector: Press the left side of the button to tune lower-frequency stations and the right side of the button to tune higher-frequency stations. When a station with a strong signal is reached, the **Tuned Indicator** **Q** will be illuminated in the **Main Information Display** **25**.

In Manual tuning mode, tap the button lightly and note that the tuner will step up one frequency increment per button press. When the button is held for a few seconds you will note that the unit will quickly advance through the frequency band. Release it and the tuner will stop. In Auto tuning mode, each press of the button will search for the next station with an acceptable signal. Press and hold the button to skip through the acceptable stations. When the button is released, the tuner will not stop until it reaches a station with an acceptable frequency.

To switch back and forth between the Auto and Manual tuning modes, press the **Tuning Mode Selector** **12**.

9 AM/FM Selector: Pressing this button will automatically switch the AVR 225 to the Tuner mode. Pressing it again will switch between the AM and FM frequency bands. (See page 28 for more information on the tuner.)

10 Preset Stations Selector: Press this button to scroll up or down through the list of stations that have been entered into the preset memory. (See page 28 for more information on tuner presets.)

11 Input Source Selector: Press this button to change the input by scrolling up or down through the list of input sources.

12 Tuning Mode Selector: Press this button to select Auto or Manual tuning. When the button is pressed so that the **Auto Indicator** **R** lights, the tuner will search for the next station with an acceptable signal when the **Tuning Selector** **8** **21** is pressed. When the button is pressed so that the **Auto Indicator** **R** is not lit, each press of the **Tuning Selector** **8** **21** will increase the frequency. This button may also be used to switch between Stereo and Mono modes for FM radio reception. When weak reception is encountered, press the button until the **Stereo Indicator** **P** goes out to switch to Mono reception. Press and hold again to switch back to Stereo mode. (See page 28 for more information on using the tuner.)

13 Digital Optical 3 Input: Connect the optical digital audio output of an audio or video product to this jack. When the input is not in use, be certain to keep the

plastic cap installed to avoid dust contamination that might degrade future performance.

14 Digital Coax 3 Jack: This jack is used for connection to the output of portable audio devices, video game consoles or other products that have a coax digital audio jack.

15 Video 4 Video Input Jacks: These jacks may be used for temporary connection to the composite or S-Video output of video games, camcorders or other portable video products.

16 Video 4 Audio Input Jacks: These audio jacks may be used for temporary connection to video games or portable audio/video products such as camcorders and portable audio players.

17 Bass Control: Turn this control to modify the low-frequency output of the left/right channels by as much as $\pm 10\text{dB}$, when the unit is in the "Surround Off" mode. Set this control to a suitable position for your taste or room acoustics.

18 Balance Control: Turn this control to change the relative volume for the front left/right channels.

NOTE: For proper operation of the surround modes this control should be at the midpoint or "12 o'clock" position.

19 Treble Control: Turn this control to modify the high-frequency output of the left/right channels by as much as $\pm 10\text{dB}$, when the unit is in the "Surround Off" mode. Set this control to a suitable position for your taste or room acoustics.

20 Volume Control: Turn this knob clockwise to increase the volume, counterclockwise to decrease the volume. If the AVR 225 is muted, adjusting the **Volume Control** **20** **34** will automatically release the unit from the silenced condition.

21 Set Button: When making choices during the setup and configuration process, press this button to enter the desired setting as shown in the **Main Information Display** **25** into the AVR 225's memory. The Set button may also be used to change the display brightness (see page 30).

22 Input Indicators: A green LED will light in front of the input that is currently being used as the source for the AVR 225.

23 Delay: Press this button to begin the sequence of steps required to enter delay time settings. (See page 18 for more information on delay times.)

24 Digital Input Selector: When playing a source that has a digital output, press this button to select

between the **Optical** **13** **24** and **Coaxial** **14** **21** digital inputs or to select the source's analog input. (See pages 26–28 for more information on digital audio.)

25 Main Information Display: This display delivers messages and status indications to help you operate the receiver. (See pages 7–8 for a complete explanation of the Information Display.)

26 Channel Select Button: Press this button to begin the process of trimming the channel output levels using an external audio source. (For more information on output level trim adjustment, see page 29.)

27 Speaker Select Button: Press this button to begin the process of configuring the unit to match the type of speakers used in your listening room. (See pages 19–21 for more information on speaker setup and configuration.)

28 Test Tone Selector: Press this button to begin the process of adjusting the channel output levels using the internal test tone as a reference. (For more information on output level adjustment, see page 21.)

29 Surround Mode Indicators: A green LED will light in front of the surround mode that is currently in use.

30 Remote Sensor Window: The sensor behind this window receives infrared signals from the remote control. Aim the remote at this area and do not block or cover it.

FRONT-PANEL INFORMATION DISPLAY

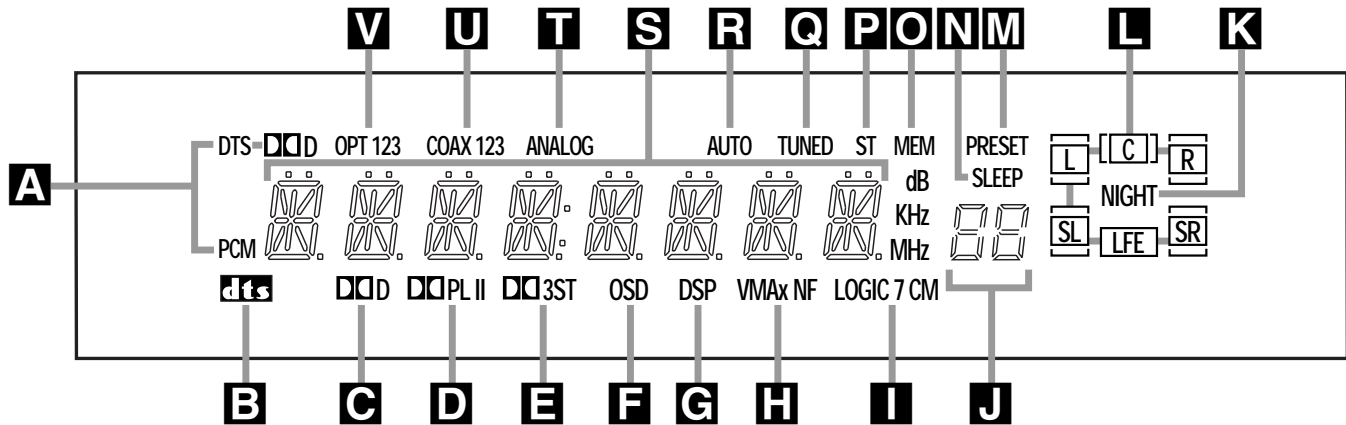

- A** Bitstream Indicators
- B** DTS Mode Indicator
- C** Dolby Digital Indicator
- D** Dolby Pro Logic II Indicator
- E** Dolby 3 Stereo/Stereo Indicator
- F** OSD Indicator
- G** DSP Mode Indicator
- H** VMAx Mode Indicators
- I** Logic 7 Mode Indicators
- J** Preset Number/Sleep Timer
- K** Night Mode Indicator
- L** Speaker/Channel Input Indicators
- M** Preset Indicator
- N** Sleep Indicator
- O** Memory Indicator
- P** Stereo Indicator
- Q** Tuned Indicator
- R** Auto Indicator
- S** Main Information Display
- T** Analog Input Indicator
- U** Coaxial Digital Input Indicators
- V** Optical Digital Input Indicators

A Bitstream Indicators: When the input is a digital source, one of these indicators will light to display the specific type of data signal in use.

B DTS Mode Indicator: This indicator lights when a DTS-encoded source is playing and DTS Surround decoding is in use.

C Dolby Digital Indicator: This indicator lights when a Dolby Digital source is being played and Dolby Digital surround decoding is in use.

D Dolby Pro Logic II Indicator: This indicator lights when the Dolby Pro Logic II mode has been selected.

- It is possible to see the Dolby Pro Logic II indicator lit simultaneously with the Dolby Digital indicator, even though the Dolby Digital surround mode has been selected. This is due to the specifications for Dolby Digital processing, which require that the Dolby Pro Logic II mode be used any time a two-channel Dolby signal is detected.
- If you desire 5.1-channel audio, check the audio settings in the menus for both your DVD player and your DVD disc to make sure that a 5.1-channel Dolby Digital soundtrack is available and has been selected.

E Dolby 3 Stereo/Stereo Indicator: The entire indicator lights when the Dolby 3 Stereo mode has been selected. When the surround modes are turned off so that two-channel stereo playback is in use, only the "ST" indicator will light.

F OSD Indicator: When the On Screen Display (OSD) system is in use, this indicator lights to remind you that the other indicators in this display do not function when the OSD is being used.

G DSP Mode Indicator: This indicator lights when any of the surround modes created by Digital Signal Processing, or DSP, are in use. These modes include Hall 1, Hall 2, the Theater Mode and 5-Channel Stereo.

H VMAx Mode Indicators: These light when the VMAx mode is in use. **VMAx F** appears when the Far Field VMAx mode is selected; **VMAx N** appears when the Near Field VMAx mode is selected. (See page 25 for a description of the VMAx modes.)

I Logic 7 Mode Indicators: These indicators light when the Logic 7 mode is in use. **LOGIC 7C** appears for the Cinema version; **LOGIC 7M** appears for the Music version of Logic 7. (See page 25 for a description of the Logic 7 modes.)

J Preset Number/Sleep Timer: When the tuner is in use, these numbers indicate the specific preset memory location in use. (See page 28 for more information on preset stations.) When the Sleep function is in use, these numbers show how many minutes remain before the unit goes into the Standby mode. (See page 24 for information on the Sleep function.)

K Night Mode Indicator: This lights when the AVR 225 is in the Night mode, which preserves the dynamic range of digital program material at low volume levels. This mode is only available with specially encoded Dolby Digital sources. (See page 27 for a description of the Night mode.)

L Speaker/Channel Input Indicators: These indicators are multipurpose, indicating either the speaker type selected for each channel or the incoming data-signal configuration. The left, center, right, right surround and left surround speaker indicators are composed of three boxes, while the subwoofer is a single box. The center box lights when a "Small" speaker is selected, and the two outer boxes light when "Large" speakers are selected. When none of the boxes are lit for the center, surround or subwoofer channels, no speaker has been assigned to one of those positions. (See page 19 for more information on configuring speakers.) The letters inside each of the center boxes display active input channels. For standard analog inputs, only the L and R will light, indicating a stereo input. When a digital source is playing, the indicators will light to display the channels being received at the digital input. When the letters flash, the digital input has been interrupted. (See page 27 for more information on the Channel Indicators.)

M Preset Indicator: This indicator lights when the tuner is in use to show that the Preset Number/Sleep Timer **J** is showing the station's preset memory number. (See page 28 for more information on tuner presets.)

FRONT - PANEL INFORMATION DISPLAY

N Sleep Indicator: This indicator lights when the Sleep function is in use. The numbers in the **Preset Number/Sleep Timer J** will show the minutes remaining before the AVR 225 goes into the Standby mode. (See page 24 for more information on the Sleep function.)

O Memory Indicator: This indicator flashes when entering presets and other information into the tuner's memory.

P Stereo Indicator: This indicator lights when an FM station is being tuned in stereo. This indicator differs from the indicator that lights when the surround decoding modes are turned off, which is described above as the **Dolby 3 Stereo/Stereo Indicator E**.

Q Tuned Indicator: This indicator lights when a station is being received with sufficient signal strength to provide acceptable listening quality.

R Auto Indicator: This indicator lights when the tuner's Auto mode is in use.

S Main Information Display: This display shows messages relating to the status, input source, surround mode, tuner, volume level or other aspects of the AVR 225's operation.

T Analog Input Indicator: This indicator lights when an analog input source has been selected.

U Coaxial Digital Input Indicators: These indicators light to show when a coaxial digital audio input has been selected.

V Optical Digital Input Indicators: These indicators light to show when an optical digital audio input has been selected.

NOTE: See page 26 for information on assigning either an analog input or one of the digital audio inputs to the source currently in use.

REAR-PANEL CONNECTIONS

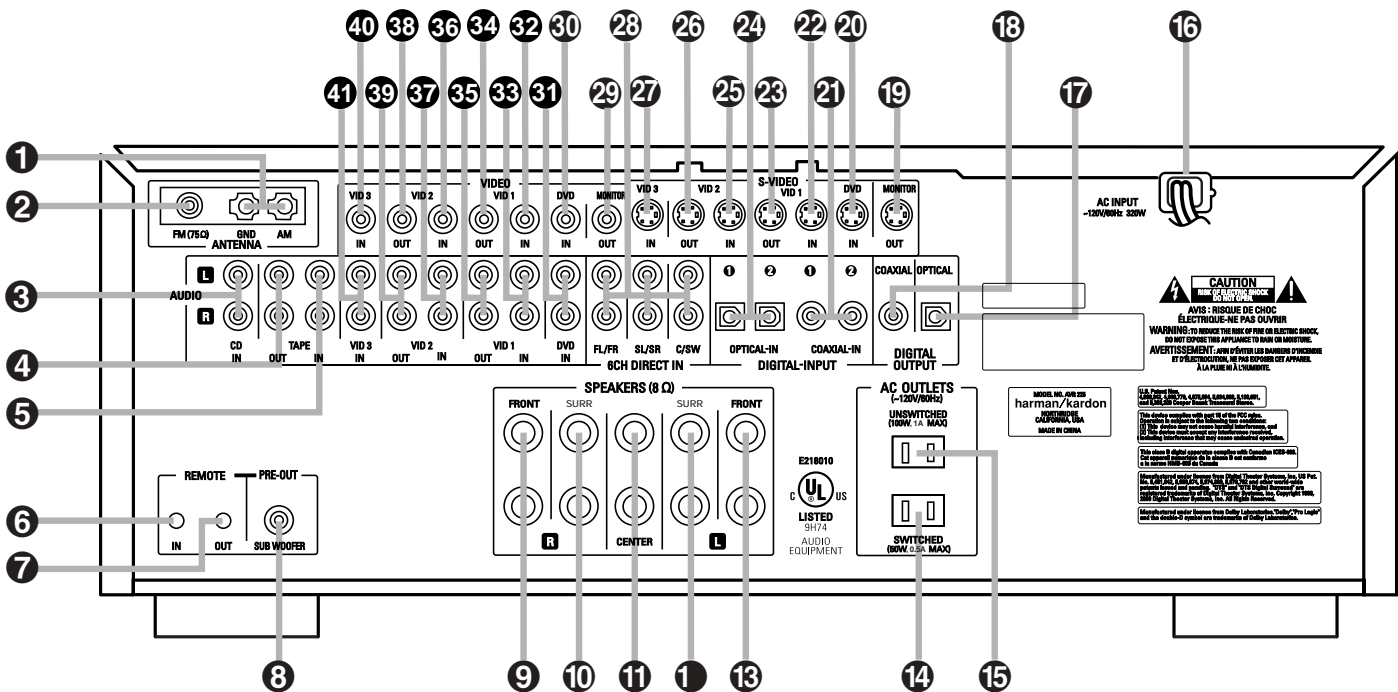

- 1 AM Antenna
- 2 FM Antenna
- 3 CD Inputs
- 4 Tape Outputs
- 5 Tape Inputs
- 6 Remote IR Input
- 7 Remote IR Output
- 8 Subwoofer Output
- 9 Front Right Speaker Outputs
- 10 Surround Right Speaker Outputs
- 11 Center Speaker Outputs
- 12 Surround Left Speaker Outputs
- 13 Front Left Speaker Outputs
- 14 Switched AC Accessory Outlet
- 15 Unswitched AC Accessory Outlet

- 16 AC Power Cord
- 17 Optical Digital Audio Output
- 18 Coaxial Digital Audio Output
- 19 Video Monitor S-Video Output
- 20 DVD S-Video Input
- 21 Coaxial Digital Audio Inputs
- 22 Video 1 S-Video Input
- 23 Video 1 S-Video Output
- 24 Optical Digital Audio Inputs
- 25 Video 2 S-Video Input
- 26 Video 2 S-Video Output
- 27 Video 3 S-Video Input
- 28 6-Channel Direct Inputs
- 29 Video Monitor Composite Video Output
- 30 DVD Composite Video Input

- 31 DVD Audio Inputs
- 32 Video 1 Composite Video Input
- 33 Video 1 Audio Inputs
- 34 Video 1 Composite Video Output
- 35 Video 1 Audio Outputs
- 36 Video 2 Composite Video Input
- 37 Video 2 Audio Inputs
- 38 Video 2 Composite Video Output
- 39 Video 2 Audio Outputs
- 40 Video 3 Composite Video Input
- 41 Video 3 Audio Inputs

1 AM Antenna: Connect the AM loop antenna supplied with the receiver to these terminals. If an external AM antenna is used, make connections to the **AM** and **GND** terminals in accordance with the instructions supplied with the antenna.

2 FM Antenna: Connect the supplied indoor (or an optional external) FM antenna to this terminal.

3 CD Inputs: Connect these jacks to the output of a compact disc player or CD changer.

4 Tape Outputs: Connect these jacks to the **RECORD/INPUT** jacks of an audio recorder.

5 Tape Inputs: Connect these jacks to the **PLAY/OUT** jacks of an audio recorder.

6 Remote IR Input: If the AVR 225's front-panel IR sensor is blocked due to cabinet doors or other obstructions, an external IR sensor may be used. Connect the output of the sensor to this jack.

7 Remote IR Output: This connection permits the IR sensor in the receiver to serve other remote-controlled devices. Connect this jack to the "IR IN" jack on Harman Kardon (or other compatible) equipment.

8 Subwoofer Output: Connect this jack to the line-level input of a powered subwoofer. If an external sub-

woofer amplifier is used, connect this jack to the subwoofer amplifier input.

9 11 13 Front Speaker Outputs: Connect these outputs to the matching + or – terminals on your front speakers. When making speaker connections, always make certain to maintain correct polarity by connecting the black terminal to the negative (–) terminal on the speakers. Connect the white terminal to the positive (+) terminal on the left front speaker, the red terminal to the positive (+) terminal on the right front speaker and the green terminal to the positive (+) terminal on the center front speaker. Newer speakers may have matching color terminals in accordance with the new

REAR-PANEL CONNECTIONS

CEA specifications, while existing speakers typically use a red terminal for the positive (+) speaker wire connection. (See page 14 for more information on speaker polarity.)

10 11 Surround Speaker Outputs: Connect these outputs to the matching + or – terminals on your left and right surround speakers. When making speaker connections always make certain to maintain correct polarity by connecting the black terminal to the negative (–) terminal on the speakers. Connect the blue terminal to the positive (+) terminal on the left surround speaker and the gray terminal to the positive (+) terminal on the right surround speaker. Newer speakers may have matching color terminals in accordance with the new CEA specifications, while existing speakers typically use a red terminal for the positive (+) speaker wire connection. (See page 14 for more information on speaker polarity.)

14 Switched AC Accessory Outlet: This outlet may be used to power any device you wish to have turned on or off at the same time as the AVR 225. Any device connected to this outlet will be off when the AVR 225 is in the Standby mode, and power will be supplied to the outlet when the AVR 225 is turned on.

15 Unswitched AC Accessory Outlet: This outlet may be used to power any AC device. The power will remain on at this outlet regardless of whether the AVR 225 is on or off.

NOTE: The total power consumption of all devices connected to the accessory outlets should not exceed 100 watts. Do not connect power amplifiers or other high-current draw devices to these outlets.

16 AC Power Cord: Connect the AC plug to an unswitched AC wall outlet.

17 Optical Digital Audio Output: Connect this jack to the matching digital audio input connector on a digital recorder such as a CD-R or MiniDisc recorder.

18 Coaxial Digital Audio Output: Connect this jack to the matching digital audio input connector on a digital recorder such as a CD-R or MiniDisc recorder.

19 29 Video Monitor Outputs: Connect these jacks to the composite or S-Video input of a TV monitor or video projector to view the on-screen menus and the output of any standard video source selected by the receiver's video switcher.

20 30 DVD Video Inputs: Connect one of these jacks to the composite or S-Video output jacks on a DVD or other video source.

21 Coaxial Digital Audio Inputs: Connect the coax digital audio output from a DVD player, HDTV receiver, LD player, satellite receiver, cable box, MiniDisc recorder or CD player to these jacks. The signal may be either a Dolby Digital signal, DTS signal or a standard PCM digital source. Do not connect the RF digital output of an LD player to these jacks.

22 32 Video 1 Video Inputs: Connect one of these jacks to the PLAY/OUT composite or S-Video jacks on a VCR or other video source.

23 34 Video 1 Video Outputs: Connect one of these jacks to the RECORD/INPUT composite or S-Video jack on a VCR.

24 Optical Digital Audio Inputs: Connect the optical digital audio output from a DVD player, HDTV receiver, LD player, satellite receiver, cable box, MiniDisc player or recorder, or CD player to these jacks. The signal may be either a Dolby Digital signal, a DTS signal or a standard PCM digital source.

25 36 Video 2 Video Inputs: Connect one of these jacks to the PLAY/OUT composite or S-Video jacks on a TV, VCR or other video source.

26 38 Video 2 Video Outputs: Connect one of these jacks to the RECORD/INPUT composite or S-Video jacks on a VCR, if you are connecting a VCR to the Video 2 inputs.

27 40 Video 3 Video Inputs: Connect one of these jacks to the PLAY/OUT composite or S-Video jacks on a cable television box, satellite dish receiver, VCR or other video source.

28 6-Channel Direct Inputs: If an external digital audio decoder is used, connect the outputs of that decoder to these jacks.

These jacks have been color-coded as follows to assist you in making correct channel connections:

Front Left	White
Front Right	Red
Center	Green
Surround Left	Blue
Surround Right	Gray
Subwoofer	Purple

31 DVD Audio Inputs: Connect these jacks to the analog audio jacks on a DVD or other source device.

NOTE: The default setting for the audio input associated with DVD is the Coaxial Digital Input 1 **21**. If you connect the audio outputs of a DVD player to these jacks

31, change the input setting as shown on page 17.

33 Video 1 Audio Inputs: Connect these jacks to the PLAY/OUT audio jacks on a VCR or other video source.

35 Video 1 Audio Outputs: Connect these jacks to the RECORD/INPUT audio jacks on a VCR.

37 Video 2 Audio Inputs: Connect these jacks to the PLAY/OUT audio jacks on a VCR or other video source, if you have connected a VCR to the Video 2 input.

39 Video 2 Audio Outputs: Connect these jacks to the RECORD/INPUT audio jacks on a VCR or other video source, if you have connected a VCR to the Video 2 input.

41 Video 3 Audio Inputs: Connect these jacks to the PLAY/OUT audio jacks on a cable television box, satellite dish receiver, VCR or other video source.

REMOTE CONTROL FUNCTIONS

- 1 Power Off Button
- 2 IR Transmitter Window
- 3 Program/SPL Indicator
- 4 Power On Button
- 5 Input Selectors
- 6 AVR Selector
- 7 AM/FM Tuner Select
- 8 Test Button
- 9 Sleep Button
- 10 Surround Mode Selector
- 11 Night Mode
- 12 Channel Select Button
- 13 ▲ Button
- 14 ◀ Button
- 15 Set Button
- 16 Digital Select
- 17 ▼ Button
- 18 Numeric Keys
- 19 Tuner Mode
- 20 Direct Button
- 21 Tuning Up/Down
- 22 OSD Button
- 23 Macro Buttons
- 24 Transport Controls
- 25 Skip Up/Down Buttons
- 26 Disc Skip Button
- 27 Preset Up/Down
- 28 Clear Button
- 29 Memory Button
- 30 Delay/Prev. Ch.
- 31 ► Button
- 32 Speaker Select
- 33 Spare Button
- 34 Volume Up/Down
- 35 TV/Video Selector
- 36 SPL Button
- 37 6-Channel Direct Input
- 38 Mute
- 39 EzSet Sensor Microphone

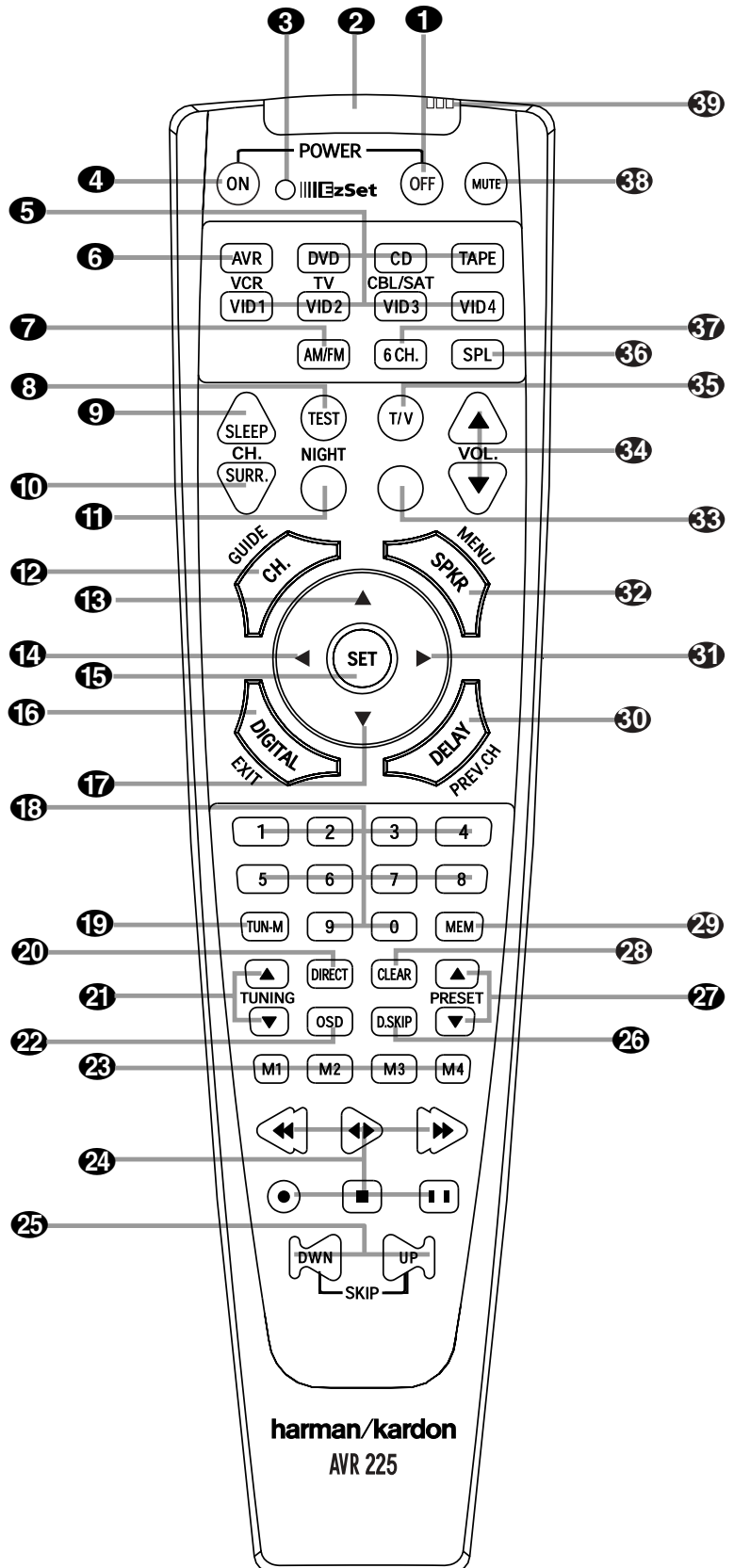

NOTE: The function names shown here are each button's feature when used with the AVR 225. Most buttons have additional functions when used with other devices. See pages 36–37 for a list of these functions.

REMOTE CONTROL FUNCTIONS

IMPORTANT NOTE: The AVR 225's remote may be programmed to control up to eight devices, including the AVR 225. Before using the remote, it is important to remember to press the **Input Selector Button 5** that corresponds to the unit you wish to operate. In addition, the AVR 225's remote is shipped from the factory to operate the AVR 225 and most Harman Kardon CD or DVD players and cassette decks. The remote is also capable of operating a wide variety of other products using the control codes that are part of the remote. Before using the remote with other products, follow the instructions on page 32 to program the proper codes for the products in your system.

It is also important to remember that many of the buttons on the remote take on different functions, depending on the product selected using the device control selectors. The descriptions shown here primarily detail the functions of the remote when it is used to operate the AVR 225. (See pages 36–37 for information about alternate functions for the remote's buttons.)

1 Power Off Button: Pressing this button turns off (places in the Standby mode) the device that was last selected by pressing one of the **Input Selectors 5**. To place the AVR 225 in the Standby mode, first press the **AVR Selector Button 6** and then press this button.

2 IR Transmitter Window: Point this window toward the AVR 225 when pressing buttons on the remote to make certain that infrared commands are properly received.

3 Program/SPL Indicator: This three-color indicator is used to guide you through the process of programming the remote and it is also used as a level indicator when using the remote's EzSet capabilities. (See page 21 for more information on setting output levels, and see page 32 for information on programming the remote.)

4 Power On Button: Press this button to turn on power to the device that was last selected by pressing one of the **Input Selectors 5**. To turn on the AVR 225, press the **AVR Selector Button 6**.

5 Input Selectors: Pressing one of these buttons will perform three actions at the same time. First, if the AVR 225 is not turned on, this will power up the unit. Next, it will select the source shown on the button as the input to the AVR 225. Finally, it will change the remote control so that it controls the device selected. After pressing one of these buttons you must press the **AVR Selector Button 6** again to operate the AVR 225's functions with the remote.

6 AVR Selector: Pressing this button will switch the remote so that it will operate the AVR 225's functions. If the AVR 225 is in the Standby mode, it will also turn the AVR 225 on.

7 AM/FM Tuner Select: Press this button to select the AVR 225's tuner as the listening choice. Pressing this button when the tuner is already in use will switch between the AM and FM bands.

8 Test Button: Press this button to begin the sequence used to manually calibrate the AVR 225's output levels. To begin automatic calibration using the EzSet feature, press the **SPL Button 36** instead of this button. (See page 21 for more information on calibrating the AVR 225.)

9 Sleep Button: Press this button to place the unit in the Sleep mode. After the time shown in the display, the AVR 225 will automatically go into the Standby mode. Each press of the button changes the time until turn-off in the following order:

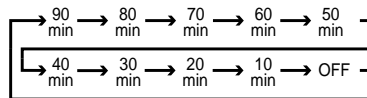

This button is also used to change channels on your TV when the TV is selected, and to end the process of creating a macro command. (See page 33 for more information on creating macros.)

10 Surround Mode Selector: Press this button to begin the process of changing the surround mode. After the button has been pressed, use the **▲/▼ Buttons 13 17** to select the desired surround mode. (See page 25 for more information.) Note that this button is also used to tune channels when the TV is selected and during the process of erasing stored macro commands. (See page 33 for more information on macros.)

NOTE: The **Sleep Button 9** and **Surround Mode Selector 10** may also function as the Channel + and – keys when the remote is programmed for use with TVs, cable boxes, VCRs, satellite receivers or other video devices with tuners. See page 34 for information on programming the remote for Channel Control Punch-Through capability so that you may change channels on a separate device when the remote is in AVR mode.

11 Night Mode: Press this button to activate the Night mode. This mode is available in specially encoded digital sources, and it preserves dialogue (center channel) intelligibility at low volume levels.

12 Channel Select Button: This button is used to start the process of setting the AVR 225's output levels to an external source. Once this button is pressed, use the

▲/▼ Buttons 13 17 to select the channel being adjusted, then press the **Set Button 15**, followed by the **▲/▼ Buttons 13 17** again, to change the level setting. (See page 29 for more information.)

13 ▲ Button: This multipurpose button is used to change or scroll through items in the on-screen menus, or to change configuration settings such as output levels. When changing an item such as the surround mode or digital input directly, first press the function or mode to be changed (e.g., press the **Surround Mode Selector 10** to select a surround mode or the **Digital Select Button 16** to change the digital input) and then press this button to scroll through the list of available choices.

14 ◀ Button: This button is used to change the menu selection or setting during some of the setup procedures for the AVR 225.

15 Set Button: This button is used to enter settings into the AVR 225's memory. It is also used in the setup procedures for delay time, speaker configuration and channel output level adjustment.

16 Digital Select: Press this button to assign one of the digital inputs **2 4 13 14** to a source. (See page 26 for more information on using digital inputs.)

17 ▼ Button: This multipurpose button is used to change or scroll through items in the on-screen menus, or to change configuration settings such as output levels. When changing an item such as the surround mode or digital input directly, first press the function or mode to be changed (e.g. press the **Surround Mode Selector 10** to select a surround mode or the **Digital Select Button 16** to change the digital input) and then press this button to scroll through the list of available choices.

18 Numeric Keys: These buttons serve as a 10-button numeric keypad to enter tuner preset positions. They are also used to select channel numbers when TV has been selected on the remote, or to select track numbers on a CD, DVD or LD player, depending on how the remote has been programmed.

19 Tuner Mode: Press this button when the tuner is in use to select between automatic tuning and manual tuning. In automatic tuning mode, the **Auto Indicator R** will be lit, and only stations with acceptable signal quality may be tuned by pressing the **Tuning Up/Down Buttons 8 21**. When the button is pressed so that the **Auto Indicator R** goes out, manual tuning mode is engaged, and pressing the **Tuning Buttons 8 21** will move the frequency up or down in single-step increments. When the FM band is in use, pressing this button when a station's signal is

weak will change to monaural reception. (See page 28 for more information.)

20 Direct Button: When the tuner is in use, press this button to start the sequence for direct entry of a station's frequency. After pressing the button simply press the proper **Numeric Keys 18** to select a station. (See page 28 for more information on the tuner.)

21 Tuning Up/Down: When the tuner is in use, these buttons will tune up or down through the selected frequency band. If the **Tuner Mode Button 19/12** has been pressed so that the **Auto Indicator R** is illuminated, pressing either of the buttons will cause the tuner to seek the next station with acceptable signal strength for quality reception. When the **Auto Indicator R** is NOT illuminated, pressing these buttons will tune stations in single-step increments. (See page 28 for more information.)

22 OSD Button: Press this button to activate the On Screen Display (OSD) system used to set up or adjust the AVR 225's parameters.

23 Macro Buttons: Press these buttons to store or recall a "Macro", which is a preprogrammed sequence of commands stored in the remote. (See page 33 for more information on storing and recalling macros.)

24 Transport Controls: These buttons do not have any functions with the AVR 225 but they may be programmed for the forward/reverse play operation of a wide variety of CD or DVD players, and audio or video cassette recorders. (See page 34 for more information on programming the Transport Control Punch-Through capability of the remote.)

25 Skip Up/Down Buttons: These buttons have no direct function with the AVR 225, but when used with a compatibly programmed CD or DVD changer they will change the track or chapter of the disc currently being played in the changer.

26 Disc Skip Button: This button has no direct function for the AVR 225, but when used with a compatibly programmed CD or DVD changer, it will change the disc currently being played in the changer. (See page 33 for more information on using the remote with other devices.)

27 Preset Up/Down: When the tuner is in use, press these buttons to scroll through the stations programmed into the AVR 225's memory. When some source devices, such as CD players, VCRs and cassette decks, are selected using the device **Input Selectors 5**, these buttons may function as Chapter Step or Track Advance.

28 Clear Button: Press this button to clear incorrect entries when using the remote to directly enter a radio station's frequency.

29 Memory Button: Press this button to enter a radio station into the AVR 225's preset memory. Once the **Memory Indicator 0** flashes, you have five seconds to enter a preset memory location using the **Numeric Keys 18**. (See page 28 for more information.)

30 Delay/Prev Ch.: Press this button to begin the process for setting the delay times used by the AVR 225 when processing surround sound. After pressing this button, the delay times are entered by pressing the **Set Button 15** and then using the **▲/▼ Buttons 13/17** to change the setting. Press the **Set Button 15** again to complete the process. (See page 18 for more information.)

31 ► Button: Press this button to change a setting or selection when configuring many of the AVR 225's settings.

32 Speaker Select: Press this button to begin the process of configuring the AVR 225's bass management system for use with the type of speakers used in your system. Once the button has been pressed, use the **▲/▼ Buttons 13/17** to select the channel you wish to set up. Press the **Set Button 15** and then select another channel to configure. When all adjustments have been completed, press the **Set Button 15** twice to exit the settings and return to normal operation. (See page 20 for more information.)

33 Spare Button: This button does not have any function for the operation of the AVR 225, but it is available for use when programmed with the code from another remote. (See page 32 for information on programming the remote with codes for other devices.)

34 Volume Up/Down: Press these buttons to raise or lower the system volume. See page 34 for more information on programming the Volume Punch-Through capability of the remote, which allows you to change the AVR 225's volume while the remote is set to control another device.

35 TV/Video Selector: This button does not have a direct function on the AVR 225, but when used with a compatibly programmed VCR, DVD or satellite receiver that has a "TV/Video" function, pressing this button will switch between the output of the player or receiver and the external video input to that player. Consult the owner's manual for your specific player or receiver for the details of how it implements this function.

36 SPL Button: This button activates the AVR 225's EzSet function to quickly and accurately calibrate the AVR 225's output levels. Press and hold the button for three seconds and then release it. The Test Tone will begin circulating, and the **Program/SPL Indicator 3** will change colors. During this sequence, EzSet will automatically adjust the output levels for all channels until they have equal output levels, as shown by the **Program/SPL Indicator 3** lighting green for each channel. (See page 21 for more information on EzSet.)

37 6-Channel Direct Input: Press this button to select the component connected to the **6-Channel Direct Inputs 28** as the source.

38 Mute: Press this button to momentarily silence the AVR 225 or TV set being controlled, depending on which device has been selected. When the AVR 225 is muted, press this button or use the **Volume Control 20/34** to return to the previous volume level.

When the AVR 225 remote is being programmed to operate another device, or when a macro command is being programmed, this button is pressed with the **Input Selector Button 5** to begin the programming process. (See page 33 for more information.)

39 EzSet Sensor Microphone: The sensor microphone for the EzSet microphone is behind these slots. When using the remote to calibrate speaker output levels using EzSet, be sure that you do not hold the remote in a way that covers these slots. (See page 21 for more information on using EzSet.)

INSTALLATION AND CONNECTIONS

System Installation

After unpacking the unit, and placing it on a solid surface capable of supporting its weight, you will need to make the connections to your audio and video equipment.

Audio Equipment Connections

We recommend that you use high-quality interconnect cables when making connections to source equipment and recorders to preserve the integrity of the signals.

When making connections to audio source equipment or speakers it is always a good practice to unplug the unit from the AC wall outlet. This prevents any possibility of accidentally sending audio or transient signals to the speakers that may damage them.

1. Connect the analog output of a CD player to the **CD Inputs 3**.

NOTE: When the CD player has both fixed and variable audio outputs it is best to use the fixed output unless you find that the input to the receiver is so low that the sound is noisy, or so high that the signal is distorted.

2. Connect the analog Play/Out jacks of a cassette deck, MD, CD-R or other audio recorder to the **Tape Input Jacks 5**. Connect the analog Record/In jacks on the recorder to the **Tape Output Jacks 4** on the AVR 225.

3. Connect the output of any digital sources to the appropriate input connections on the AVR 225 rear panel. The **Optical and Coaxial Digital Inputs 21 23 13 14** may be used with a Dolby Digital or DTS source such as a DVD player, or the output of a conventional CD or LD player's PCM (S/P-DIF) output.

4. Connect the **Optical Digital Audio Output 17** or the **Coaxial Digital Audio Output 18** on the rear panel of the AVR 225 to the matching digital input connections on a CD-R or MiniDisc recorder.

5. Assemble the AM Loop Antenna supplied with the unit as shown below. Connect it to the **AM and GND Screw Terminals 1**.

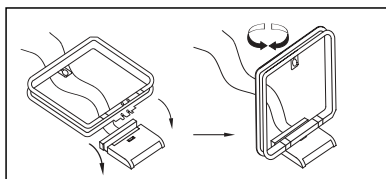

6. Connect the supplied FM antenna to the **FM Antenna (75-Ohm) Connection 2**. The FM antenna may be an external roof antenna, an inside powered or wire lead antenna or a connection from a

cable TV system. Note that if the antenna or connection uses 300-ohm twin-lead cable, you must use the 300-ohm-to-75-ohm adapter supplied with the unit to make the connection.

7. If you have a DVD-Audio or SACD player, or other component that includes an onboard surround decoder and 6-channel line-level audio outputs, you may connect these audio outputs to the **6-Channel Direct Inputs 28**.

8. Connect the front, center and surround **Speaker Outputs 9 10 11 13** to the respective speakers.

To ensure that all the audio signals are carried to your speakers without loss of clarity or resolution, we suggest that you use high-quality speaker cable. Many brands of cable are available and the choice of cable may be influenced by the distance between your speakers and the receiver, the type of speakers you use, personal preferences and other factors. Your dealer or installer is a valuable resource to consult in selecting the proper cable.

Regardless of the brand of cable selected, we recommend that you use a cable constructed of fine, multistrand copper with a gauge of 14 or smaller. Remember that in specifying cable, the lower the number, the thicker the cable.

Cable with a gauge of 16 may be used for short runs of less than 10 feet. We do not recommend that you use cables with an AWG equivalent of 18 or higher due to the power loss and degradation in performance that will occur.

Cables that are run inside walls should have the appropriate markings to indicate listing with UL, CSA or other appropriate testing agency standards. Questions about running cables inside walls should be referred to your installer or a licensed electrical contractor who is familiar with the NEC and/or the applicable local building codes in your area.

When connecting wires to the speakers, be certain to observe proper polarity. Remember to connect the "negative" or "black" wire to the same terminal on both the receiver and the speaker. The AVR 225 conforms to the latest CEA-recommended color-coding for speaker terminals. Accordingly, the positive (+) terminal, which was previously red, is now a specific color to assist you in making the correct connections. If your speakers have color-coded connections, match the terminal on the AVR 225 to the like terminal on your speakers. For existing speakers with a red terminal for the positive connection, the connections on the AVR 225 are as follows:

Front Left = White Front Right = Red
Center = Green
Surround Left = Blue Surround Right = Gray

NOTE: While most speaker manufacturers adhere to an industry convention of using black terminals for negative and red ones for positive, some manufacturers may vary from this configuration. To ensure proper phase and optimal performance, consult the identification plate on your speaker or the speaker's manual to verify polarity. If you do not know the polarity of your speaker, ask your dealer for advice before proceeding, or consult the speaker's manufacturer.

We also recommend that the length of cable used to connect speaker pairs be identical. For example, use the same length piece of cable to connect the front-left and front-right or surround-left and surround-right speakers, even if the speakers are a different distance from the AVR 225.

9. Connections to a subwoofer are normally made via a line-level audio connection from the **Subwoofer Output 8** to the line-level input of a subwoofer with a built-in amplifier. When a passive subwoofer is used, the connection first goes to a power amplifier, which will be connected to one or more subwoofer speakers. If you are using a powered subwoofer that does not have line-level input connections, follow the instructions furnished with the speaker for connection information.

Video Equipment Connections

Video equipment is connected in the same manner as audio components. Again, the use of high-quality interconnect cables is recommended to preserve signal quality.

Although any compatible video device may be connected to any video input (with the exception of the **Video 1 and Video 2 Out Jacks 23 25 34 35 38 39**, which may only be connected to a video recorder), to make programming device codes into the remote control easier, we recommend that you connect your VCR to the **Video 1 Connectors 22 23 32 33 34 35**, your television to the **Video 2 Input Connectors 25 36 37**, and your cable-TV converter or satellite receiver to the **Video 3 Input Connectors 27 40 41**.

1. Connect a VCR's or other video source's audio and video Play/Out jacks to the **Video 1 or Video 2 In Jacks 22 25 32 33 36 37** on the rear panel. The Audio and Video Record/In jacks on the VCR should be connected to the **Video 1 or Video 2 Out Jacks 23 26 34 35 38 39** on the AVR 225.

2. Connect the analog audio and video outputs of a television set or any other video source to the **Video 2 Input Jacks 25 36 37**.

3. Connect the analog audio and video outputs of a cable TV converter or satellite receiver, or any other video source, to the **Video 3 Jacks 27 40 41**.

4. Connect the analog audio and video outputs of a DVD or laser disc player to the **DVD Jacks 20 30 31**. When a digital audio connection is used for your DVD player, the default connection is the **Coaxial Digital Audio Input 1 Jack 21**. However, the connection may also be made to any of the **Optical 24 13** or **Coaxial 21 14** digital audio inputs, provided that the digital input source selection is changed as shown on pages 17 and 26. If your DVD or DVD-Audio player includes an onboard surround decoder and 6-channel line-level audio outputs, you may connect these audio outputs to the **6-Channel Direct Inputs 23**. When you wish to hear this decoded audio, select the DVD input first in order to select the video signal from the DVD player, then select the 6-Channel Direct Input source for the audio.

5. Connect the digital audio outputs of a DVD player, satellite receiver, cable box or HDTV converter to the appropriate **Optical** or **Coaxial Digital Audio Inputs 21 24 13 14**.

6. Connect the **Video Monitor Output 19 29** jacks on the receiver to the composite or S-Video input of your television monitor or video projector.

VIDEO CONNECTION NOTE:

- Composite and S-Video signals may only be viewed in their native formats. The AVR 225 will not convert signals from composite to S-Video, or vice versa. S-Video inputs may only be viewed when the AVR 225 is connected to a TV set or video display with S-Video capability. If you use both standard composite video and S-Video sources in your system, it is important that you connect both an S-Video cable and a standard composite video cable (a coax cable with an RCA plug on both ends) between the AVR 225 and your TV or projector. When it is necessary to make both types of connections to your TV set, use different inputs if possible. Consult the instructions for your TV set or projector for more information on connecting both types of signals.

Power Connections

This unit is equipped with two accessory AC outlets. They may be used to power accessory devices, but they should not be used with high-current draw equipment such as power amplifiers. The total power draw to each outlet may not exceed 100 watts.

The **Switched AC Accessory Outlet 14** will receive power only when the unit is on. This is recommended for devices that have no power switch or a mechanical power switch that may be left in the "ON" position.

NOTE: Many audio and video products go into a Standby mode when they are used with switched outlets, and cannot be fully turned on using the outlet alone without a remote control command.

The **Unswitched AC Accessory Outlet 15** will receive power as long as the unit is plugged into a powered AC outlet.

Finally, when all connections are complete, plug the **Power Cord 16** into a nonswitched 120-volt AC wall outlet. You're almost ready to enjoy the AVR 225!

SYSTEM CONFIGURATION

When all audio, video and system connections have been made, there are a few configuration adjustments that must be made. A few minutes spent to correctly configure and calibrate the unit will greatly add to your listening experience.

Speaker Selection and Placement

The placement of speakers in a multichannel home theater system can have a noticeable impact on the quality of sound reproduced. No matter which type or brand of speakers is used, the same model or brand of speaker should be used for the left front, center and right front speakers. This creates a seamless front soundstage and eliminates the possibility of distracting sonic disturbances that occur when a sound moves across mismatched front-channel speakers.

Speaker Placement

Depending on the type of center channel speaker in use and your viewing device, place the center speaker either directly above or below your TV, or in the center behind a perforated front projection screen.

Once the center channel speaker is installed, position the left front and right front speakers so that they are as far away from one another as the center channel speaker is from the preferred listening position. Ideally, the front-channel speakers should be placed so that their tweeters are no more than 24" above or below the tweeter in the center channel speaker.

Depending on the specifics of your room acoustics and the type of speakers in use, you may find that imaging is improved by moving the left front and right front speakers slightly forward of the center channel speaker. If possible, adjust all front loudspeakers so that they are aimed at ear height when you're seated in the listening position.

Using these guidelines, you'll find that it takes some experimentation to find the correct location for the front speakers in your particular installation. Don't be afraid to move things around until the system sounds correct. Optimize your speakers so that audio transitions across the front of the room sound smooth and sounds from all speakers appear to arrive at the listening position at the same time (without delay from the center speaker compared to the left and right speakers).

Surround speakers should be placed on the side walls of the room, at or slightly behind the listening position. The center of the speaker should face into the room. The speakers should be located so that the bottom of the cabinet is at least two feet higher than the listeners' ears when the listeners are seated in the desired area.

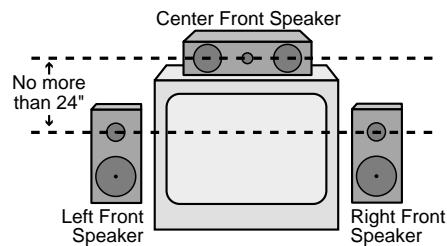

A) Front-Channel Speaker Installation with Direct-View TV Sets or Rear-Screen Projectors

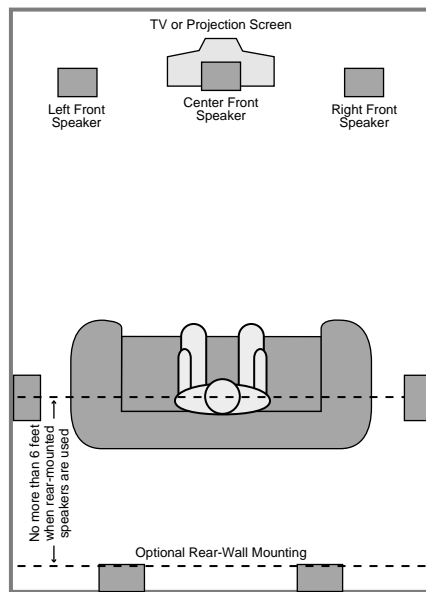

B) The distance between the left and right speakers should be equal to the distance from the seating position to the viewing screen. You may also experiment with placing the left and right speakers slightly forward of the center speaker.

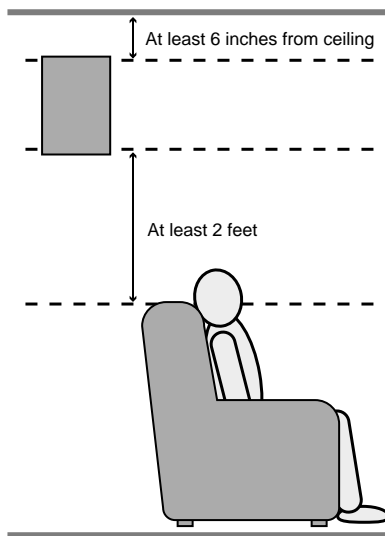

C) Optimal placement of surround speakers.

If side-wall mounting is not practical, the speakers may be placed on a rear wall, behind the listening position. Again, they should be located so that the bottom of the cabinet is at least two feet higher than the listeners' ears. The speakers should be no more than six feet behind the rear of the seating area.

Subwoofers produce nondirectional sound, so they may be placed almost anywhere in a room. Actual placement should be based on room size and shape and the type of subwoofer used. One method of finding the optimal location for a subwoofer is to begin by placing it in the front of the room, about six inches from a wall, or near the front corner of the room. Another method is to temporarily place the subwoofer at your normal listening position, and then walk around the room until you find a spot where the subwoofer sounds best. Place the subwoofer in that spot. You should also follow the instructions of the subwoofer's manufacturer, or you may wish to experiment with the best location for a subwoofer in your listening room.

System Setup

Once the speakers have been placed in the room and connected, the remaining steps in the setup process are to program the AVR 225's bass management system for the type of speakers used in your system, calibrate the output levels, and set the delay times used by the surround sound processor.

You are now ready to power up the AVR 225 to begin these final adjustments.

1. Plug the **Power Cord 16** into an unswitched AC outlet.
2. Press the **Main Power Switch 1** in until it latches and the word "OFF" on the top of the switch disappears inside the front panel. The **Power Indicator 3** will turn amber, indicating that the unit is in the Standby mode.
3. Remove the protective plastic film from the front-panel lens. If left in place, the film may affect the performance of your remote control.
4. Install the three supplied AAA batteries in the remote as shown. Be certain to follow the (+) and (-) polarity indicators that are on the bottom of the battery compartment.

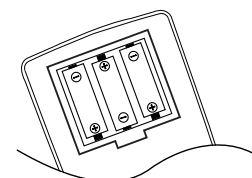

- Turn the AVR 225 on either by pressing the **System Power Control** **2** on the front panel, or via the remote by pressing the **AVR Selector** **6** or any of the **Input Selectors** **5 7 37** on the remote. The **Power Indicator** **3** will turn green to confirm that the unit is on, and the **Main Information Display** **25** will also light up.

Using the On-Screen Display To Make Configuration Adjustments

When making the following adjustments, you may find it easier to use the AVR 225's on-screen display system. These easy-to-read displays give you a clear picture of the current status of the unit and make it easy to see which speaker, delay, input or digital selection you are making.

To view the on-screen menus, make certain you have made a connection from the **Video Monitor Out Jacks** **19 29** on the rear panel to the composite or S-Video input of your TV or projector. In order to view the AVR 225's displays, the correct video source must be selected on the TV or other video display.

IMPORTANT NOTE: When viewing the displays on a projection TV it is important that they not be left on the screen for an extended period of time. As with any video display, but particularly with projectors, constant display of a static image such as these menus or video game images may cause the image to be permanently "burned into" the CRT. This type of damage is not covered by the AVR 225 warranty and may not be covered by the projector TV set's warranty.

The AVR 225 has two on-screen display modes, "Semi-OSD" and "Full-OSD." When making configuration adjustments, it is recommended that the Full-OSD mode be used. This will place a complete status report or option listing on the screen, making it easier to view the available options. The Semi-OSD mode uses one-line displays only.

The Full-OSD system is always available by pressing the **OSD Button** **22**. When this button is pressed, the **MASTER MENU** (Figure 1) will appear, and adjustments are made from the individual menus. The Semi-OSD system is also available as a system default, although it may be turned off by using the **ADVANCED** menu (see page 30). With the Semi-OSD system, you may make adjustments directly, by pressing the buttons on the front panel or remote control for the specific parameter to be adjusted. For example, press the **Speaker Select Button** **32 27** to set the speaker configuration, etc.

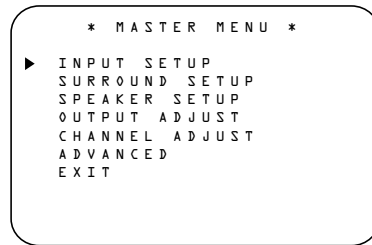

Figure 1

When the Full-OSD system is in use, the menu selections are not shown in the **Main Information Display** **25 S**. When the Full-OSD menu system is used, **OSD ON** will appear in the **Main Information Display** **S** and the **OSD Indicator** **F** will light to remind you that a video display must be used. When the Semi-OSD system is used in conjunction with the discrete configuration buttons, the on-screen display will show a single line of text with the current menu selection. That selection will also be shown in the **Main Information Display** **S**.

To use the Full-OSD menu system, press the **OSD Button** **22**. When the menu is on the screen, press the **▲/▼ Buttons** **13 17** until the on-screen **▶** cursor is next to the item you wish to adjust, and then press the **Set Button** **15** to adjust that item. Note that the menus will remain on the screen for 20 seconds, and then they will "time-out" and disappear from the screen. The time-out may be increased to as much as 50 seconds by going to the **ADVANCED** menu, and changing the item titled **FULL OSD TIME OUT**.

Setting the System Configuration Memories

The AVR 225 features an advanced memory system that enables you to establish different configurations for the bass management, digital input, surround mode, delay times and output levels for each input source. This flexibility enables you to custom-tailor the way in which you listen to each source and have the AVR 225 memorize those settings. This means, for example, that you may use different output levels or trims for different sources, or set different speaker configurations with the resultant changes to the bass management system. Once these settings are made, they will automatically be recalled whenever you select that input.

The factory default settings for the AVR 225 have all inputs configured for an analog source (except for the DVD input, which has the **Coaxial Digital Audio Input 1** **21** as the default), Stereo as the surround mode, all speaker positions set to "Small," and a sub-woofer connected. Before using the unit, you will probably want to change the settings for most inputs so that they are properly configured to reflect the use

of digital or analog inputs, the type of speakers installed and the surround mode specifics. Remember that since the AVR 225 memorizes the settings for each input individually, you will need to make these adjustments for each input used. However, once they are made, further adjustment is only required when system components are changed.

To make this process as quick and as easy as possible, we suggest that you use the Full-OSD system with the on-screen menus, and step through each input. Once you have completed the settings for the first input, many settings may be duplicated for the remaining inputs. It is also a good idea to set the configuration data in the order these items are listed in the **MASTER MENU**, as some settings require a specific entry in a prior menu item. Remember that once the settings are made for one input, they must be made for all other input sources in your system.

Input Setup

The first step in configuring the AVR 225 is to select an input. This may be done by pressing the front-panel **Input Source Selector** **11** until the desired input's name appears momentarily in the **Main Information Display** **S**, and the green LED lights next to the input's name in the front-panel **Input Indicators** **22**. The input may also be selected by pressing the appropriate **Input Selector** **5 7 37** on the remote control.

When using the Full-OSD system to make the setup adjustments, press the **OSD Button** **22** once so that the **MASTER MENU** (Figure 1) appears. Note that the **▶** cursor will be next to the **INPUT SETUP** line. Press the **Set Button** **15** to enter the menu and the **INPUT SETUP** menu (Figure 2) will appear on the screen. Press the **◀▶ Buttons** **14 31** until the desired input name appears in the highlighted video, as well as being indicated in the front-panel **Input Indicators** **22** by the green LED next to the desired input name. If the input will use the standard left/right analog inputs, no further adjustment is needed.

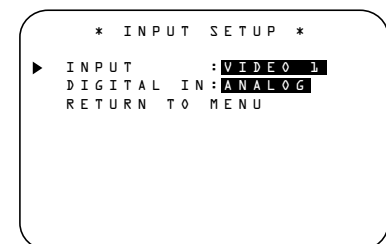

Figure 2

If you wish to associate one of the digital inputs with the selected input source, press the **▼ Button** **17** on the remote while the **INPUT SETUP** menu

SYSTEM CONFIGURATION

(Figure 2) is on the screen, and the on-screen cursor will drop down to the **DIGITAL IN** line. Press the **◀▶ Buttons 14 31** until the name of the desired digital input appears. To return to the analog input, press the buttons until the word **ANALOG** appears. When the correct input source appears, press the **▼ Button 17** until the **▶** cursor appears next to **RETURN TO MENU**, and press the **Set Button 15**.

To change the digital input at any time using the discrete function buttons and the Semi-OSD system, press the **Digital Input Select Button 24 16** on the front panel or the remote. Within five seconds, make your input selection using the **Selector Buttons 5** on the front panel or the **▲/▼ Buttons 13 17** on the remote until the desired digital or analog input is shown in the **Main Information Display 5** and in the lower third of the video display connected to the AVR 225. Press the **Set Button 15** to enter the new digital input assignment. When the Stereo-Direct (Surround Off) mode is in use, you may only select the analog input for a source. When the Stereo-Digital mode is in use, you may select from any of the digital inputs that you have connected to your source components.

Surround Setup

Once the basic input setup has been completed, the next step is to set the surround mode you wish to use with an input. Since surround modes are a matter of personal taste, feel free to select any mode you wish – you may change it later. However, to make it easier to establish the initial parameters for the AVR 225, it is best to select Dolby Pro Logic II for most analog inputs and Dolby Digital for inputs connected to digital sources. In the case of inputs such as a CD Player, Tape Deck or Tuner, you may wish to set the mode to one of the two Stereo modes, as they are not typically used with multichannel surround-encoded program material. Analog Stereo-Direct mode bypasses the digital signal-processing circuitry for a completely analog signal path that preserves the purity of the original signal, and Stereo-Digital mode provides bass management for optimal distribution of the low frequencies between smaller speakers and a subwoofer. Alternatively, the Logic 7 Music mode is a good choice for stereo-only source material.

NOTE: When a Logic 7 mode is in use with a Dolby Digital 2.0 digital input source, that mode, rather than Logic 7, will be used by the AVR after the digital bitstream is interrupted for any reason, such as stopping or pausing the digital playback. Note, also, that Logic 7 is not available with digital playback unless a two-channel bitstream is in use.

It is easiest to complete the surround setup using the Full-OSD on-screen menus. From the **MASTER MENU** (Figure 1), press the **▲/▼ Buttons 13 17** until the **▶** cursor is next to the **SURROUND SETUP** menu. Press the **Set Button 15** so that the **SURROUND SETUP** menu (Figure 3 or 4) is on the screen.

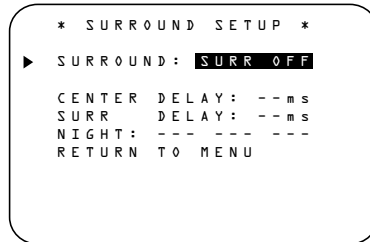

Figure 3

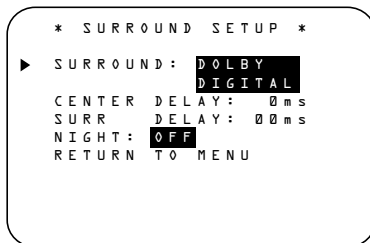

Figure 4

Since the factory default for all inputs is Stereo, the phrase **SURR OFF** will initially appear in highlighted video (Figure 3). To change the surround mode while the **▶** cursor is next to the surround line, press the **◀▶ Buttons 14 31** until the desired surround mode's name appears in the highlighted video. As the modes are changed, a green LED will also light next to the mode names in the **Surround Mode Indicators 29** on the front panel.

Note that the data lines next to the items in the screen display will show either numbers or a series of dashes, depending on whether or not the specific parameter is adjustable. For example, the Center Delay and Night Mode items are only adjustable for Dolby Digital, and the Delay Time is only adjusted for Dolby Digital and Dolby Pro Logic II. Note, also, that Dolby Digital and DTS will only appear as choices (Figure 4) when a digital input was previously selected.

Depending on the surround mode selected, you may now proceed to change the delay time. For Dolby Digital and Dolby Pro Logic II, pressing the **▲/▼ 13 17** buttons on the remote will take you to the delay settings.

Delay Settings

If Dolby Digital or Dolby Pro Logic II is selected as the surround mode for an input, you may need to adjust the delay time setting. Note that the delay time is not adjustable for any other modes.

Due to the different distances between the front-channel speakers and the listening position compared to the surround speakers and the listening position, the amount of time it takes for sound to reach your ears from the front or surround speakers may differ. You may compensate for this difference through the use of the delay settings to adjust the timing to tailor the specific speaker placement and acoustic conditions in your listening room or home theater.

The factory setting is appropriate for most rooms, but some installations create an uncommon distance between the front and surround speakers that may cause the arrival of front-channel sounds to become disconnected from surround-channel sounds.

To resynchronize the front and surround channels, follow these steps:

1. Measure the distance from the listening/viewing position to the front speakers.
2. Measure the distance from the listening/viewing position to the surround speakers.
3. Subtract the distance to the surround speakers from the distance to the front speakers.
 - a. When setting the delay time for the Dolby Digital surround mode, the optimal delay time is the result of that subtraction. For example, if the front speakers are 10 feet away and the surround speakers are five feet away, the optimal delay time is figured as $10 - 5 = 5$. Thus, in this example, the delay time for Dolby Digital should be set at five milliseconds.
 - b. When setting the delay time for the Pro Logic II mode, take the result of the subtraction and add 15 to obtain the optimal delay time. For example, if the front speakers are 10 feet away and the surround speakers are five feet away, the optimal delay time is figured as $10 - 5 + 15 = 20$. Thus, in this example, the Pro Logic II delay should be set at 20 milliseconds.

NOTE: The DTS, Logic 7, Hall and Theater modes use a fixed, nonadjustable delay time.

The Dolby Digital mode also includes a separate setting for the center channel delay mode, since the discrete nature of these signals makes the location of the

center channel speaker more critical. To calculate the delay for the center channel, measure the distance from the preferred listening position in the center of the room to both the center channel speaker and either the left or right speaker.

If the distances are equal, no further adjustment is required and the center delay should be set to zero. If the distance to the front speakers is greater than the distance to the center speaker, you may wish to reposition the speakers by moving the front left and front right speakers closer to the listening position or the center speaker further away from the listening position.

If repositioning of the speakers is not possible, adjust the center delay time, adding one millisecond of center channel delay for every foot closer to the listening position the center speaker is than the front speakers. For example, if the front left and front right speakers are each 10 feet from the listening position and the center channel speaker is eight feet away, the delay is figured as $10 - 8 = 2$, suggesting an optimal center delay of two milliseconds.

To set the delay time for a specific input, continue within the **SURROUND SETUP** (Figure 4) menu. If the system is not already at that point, press the **OSD Button 22** to bring up the **MASTER MENU**; press the **▼ Button 17** and then the **Set Button 15** to bring up the **SURROUND SETUP** menu, and then press the **▼ Button 17** once.

If the Dolby Digital mode is selected, the **▶** cursor will stop at the **CENTER DELAY** line. In that case, press the **◀/▶ Buttons 14 31** until the number calculated using the formula shown above appears in the display. When the **CENTER DELAY** is entered, press the **▼ Button 17** once to move to the next line.

When the **CENTER DELAY** is set, or if the Dolby Pro Logic II mode is selected, the **▶** cursor will be at the **SURR DELAY** line so that the delay for the surround speakers may be set. Press the **◀/▶ Buttons 14 31** until the number calculated using the formula shown above appears in the display. When the delay settings are complete, press the **▼ Button 17** once to move to the next line.

Note that the delay settings may also be adjusted at any time when the Dolby Digital or Dolby Pro Logic II modes are in use by pressing the **Delay Button** on the front panel **23** or remote **30**, followed by a press of the **Set Button 21 15**. Next, press the **▲/▼ Buttons 13 17** on the remote or the **Selector Buttons 5** on the front panel until the desired figure appears in the **Main Information Display S**.

Night Mode Settings

The Night mode is a feature of Dolby Digital that uses special processing to preserve the dynamic range and full intelligibility of a movie soundtrack, particularly the dialogue, while reducing the peak level. This prevents abruptly loud transitions from disturbing others, without reducing the sonic impact of a digital source. Note that the Night mode is only available when specially encoded Dolby Digital signals are played.

To adjust the Night mode setting for an input from the menu, make certain that the **▶** cursor is on the **NIGHT** line of the **SURROUND SETUP** menu (Figure 4). Next, press the **◀/▶ Buttons 14 31** to choose among the following settings, as they appear in the on-screen display:

OFF: When **OFF** is highlighted, the Night mode will not function.

MID: When **MID** is highlighted, a mild compression will be applied.

MAX: When **MAX** is highlighted, a more severe compression algorithm will be applied.

We recommend that you select the **MID** setting initially and change to the **MAX** setting later, if desired.

Note that the Night mode may be adjusted directly any time that a Dolby Digital source is playing by pressing the **Night Button 11**. When the button is pressed, the phrase **D-RANGE** will appear in the lower third of the video screen and in the **Main Information Display S**. Press the **▲/▼ Buttons 13 17** within three seconds to select the desired setting.

When all settings for the surround setup have been made, press the **▲/▼ Buttons 13 17** so that the **▶** cursor is next to **RETURN TO MENU**, and press the **Set Button 15** to return to the main menu.

Speaker Setup

This menu tells the AVR 225 which type of speakers are in use. This is important as it adjusts the settings that determine which speakers receive low-frequency (bass) information. For each of these settings use the **LARGE** setting if the speakers for a particular position are traditional full-range loudspeakers that are capable of reproducing sounds below 100Hz. Use the **SMALL** setting for smaller, frequency-limited satellite speakers that do not reproduce sounds below 100Hz. Note that when "small" speakers are used, a subwoofer is required to reproduce low-frequency sounds. Remember that the "large" and "small" descriptions do not refer to the actual physical size of the speakers, but to their ability to reproduce low-frequency sounds. If you are in doubt as to which

category describes your speakers, consult the specifications in the speakers' owner's manual, or ask your dealer.

If you haven't done so previously, place the AVR 225 in Dolby Pro Logic II – Movie mode by using the **SURROUND SETUP** menu (Figure 3) as described on page 18. It is easiest to enter the proper settings for the speaker setup through the **SPEAKER SETUP** menu (Figure 5). If that menu is not already on your screen from the prior adjustments, press the **OSD Button 22** to bring up the **MASTER MENU** (Figure 1), and then press the **▼ Button 17** twice so that the cursor is on the **SPEAKER SETUP** line. At this point, press the **Set Button 15** to bring up the **SPEAKER SETUP** menu (Figure 5).

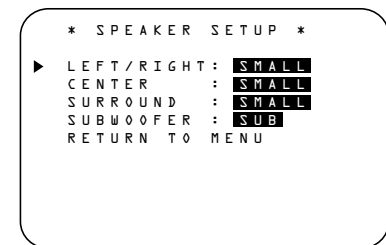

Figure 5

When the **SPEAKER SETUP** menu first appears, the on-screen cursor **▶** will be at the top of the list of speaker positions, pointing toward the **LEFT/RIGHT** line, which sets the configuration for the front left and right speakers. If you wish to make a change to the front speakers' configuration, press the **◀/▶ Buttons 14 31** so that either **LARGE** or **SMALL** appears, matching the type of speakers you have at the left-front and right-front positions, as described by the definitions shown in the preceding section.

When **SMALL** is selected, low-frequency sounds below 100Hz will be sent only to the subwoofer output. Note that if you choose this option and there is no subwoofer connected, you will not hear any low-frequency sounds from the front channels.

When **LARGE** is selected, a full-range output will be sent to the front left and front right outputs. Depending on the choice made in the **SUBWOOFER** line in this menu, bass information may also be directed to the front left/right speakers, a subwoofer or both.

When you have completed your selection for the front channel, press the **▼ Button 17** on the remote to move the cursor to **CENTER**.

SYSTEM CONFIGURATION

Press the ◀▶ Buttons 14 31 on the remote to select the option that best describes your system based on the speaker definitions shown below.

When **SMALL** is selected, low-frequency center-channel sounds below 100Hz will be sent only to the subwoofer output. Note that if you choose this option and there is no subwoofer connected, you will not hear any low-frequency sounds from the center channel speaker.

When **LARGE** is selected, a full-range output will be sent to the center speaker output, and NO center-channel signal will be sent to the subwoofer output.

NOTE: If you choose Logic 7 as the surround mode for the particular input source for which you are configuring your speakers, the AVR 225 will not make the "large" option available for the center speaker. This is due to the requirements of Logic 7 processing, and does not indicate a problem with your receiver.

When **NONE** is selected, no signals will be sent to the center-channel output. The receiver will operate in a "phantom" center-channel mode and center-channel information will be sent to the left and right front-channel outputs. When only front left and right speakers are used, with no center or surround speakers, VMaX is a good alternative mode.

When you have completed your selection for the center channel, press the ▼ Button 17 on the remote to change the cursor to **SURROUND**.

Press the ◀▶ Buttons 14 31 on the remote to select the option that best describes the surround speakers in your system based on the speaker definitions shown previously.

When **SMALL** is selected, low-frequency surround-channel sounds below 100Hz will be sent to the subwoofer output only. Note that if you choose this option and there is no subwoofer connected, you will not hear any low-frequency sounds from the surround speakers.

When **LARGE** is selected, a full-range output will be sent to the surround-channel outputs, and NO surround-channel signals will be sent to the subwoofer output.

When **NONE** is selected, surround sound information will be split between the front left and right outputs. Note that for optimal performance when no surround speakers are in use, the Dolby 3 Stereo mode should be used instead of Dolby Pro Logic II. If only front left and right speakers are available, select one of the two VMaX modes or "Surround Off".

When you have completed your selection for the surround channel, press the ▼ Button 17 on the remote to move the cursor to **SUBWOOFER**.

Press the ◀▶ Buttons 14 31 on the remote to select the option that best describes your system.

The choices available for the subwoofer position will depend on the settings for the other speakers, particularly the front left/right positions.

If the front left/right speakers are set to **SMALL**, the subwoofer will automatically be set to **SUB**, which is the "on" position.

If the front left/right speakers are set to **LARGE**, three options are available:

- If no subwoofer is connected to the AVR 225, press the ◀▶ Buttons 14 31 on the remote so that **NONE** appears in the on-screen menu. When this option is selected, all bass information will be routed to the front left/right "main" speakers.
- If a subwoofer is connected to the AVR 225, you have the option to have the front left/right "main" speakers reproduce bass frequencies at all times, and have the subwoofer operate only when the AVR 225 is being used with a digital source that contains a dedicated Low-Frequency Effects, or LFE, soundtrack. This allows you to use both your main and subwoofer speakers to take advantage of the special bass created for certain movies. Press the ◀▶ Buttons 14 31 on the remote so that **SUB (LFE)** appears in the on-screen menu.
- If a subwoofer is connected and you wish to use it for bass reproduction in conjunction with the main front left/right speakers, regardless of the type of program source or surround mode you are listening to, press the ◀▶ Buttons 14 31 on the remote so that **SUB L/R+LFE** appears in the on-screen menu. When this option is selected, a "complete" feed will be sent to the front left/right "main" speakers, and the subwoofer will receive bass frequencies below 100Hz.

When all speaker selections have been made, press the ▼ Button 17 until the on-screen ► cursor points to **RETURN TO MENU** and press the Set Button 15 to return to the **MASTER MENU**.

The speaker configuration may also be changed at any time without using the Full-OSD on-screen menu system by pressing the **Speaker Select** button on the front panel 27 or remote 32. Once the button is pressed, **FNT SPKR** will appear in both the lower

third of the video display and the **Main Information Display S**.

Within three seconds, press either the front-panel ◀▶ **Selector Buttons 5** or the ▲/▼ Buttons 13 17 on the remote to select a different speaker position, or press the **Set Button 21 15** to begin the adjustment process for the front left and right speakers.

When the **Set Button 21 15** has been pressed and the system is ready for a change to the speaker setting, the on-screen display and **Main Information Display S** will read **FNT LARGE** or **FNT SMALL**, depending on the current setting. Press the front-panel ◀▶ **Selector Buttons 5** or the ▲/▼ Buttons 13 17 on the remote until the desired setting is shown, using the instructions for "large" or "small" described earlier.

If the configuration for another speaker position needs to be changed, press the front-panel ◀▶ **Selector Buttons 5** or the ▲/▼ Buttons 13 17 on the remote to select a different speaker position, and then press the front-panel ◀▶ **Selector Buttons 5** or the ▲/▼ Buttons 13 17 on the remote until the correct speaker setting is shown.

To assist in making speaker configuration settings, the icons in the **Speaker/Channel Input Indicators L** change as the speaker type is selected at each position. When only the center icon box containing the abbreviation for the speaker position is lit, the speaker is set for "small." When the inner box and the two outer boxes with circles inside them are lit, the speaker is set for "large." When no indicator appears at a speaker location, that position is set for "none" or "no" speaker.

NOTE: These icons are available only when making setup changes in the Semi-OSD mode.

For example, in Figure 6, the left-front and right-front speakers are set for "large"; the center, left-surround (SL) and right-surround (SR) speakers are set for "small," and a subwoofer is set, as shown by the box with the abbreviation "LFE", which stands for "low-frequency effects."

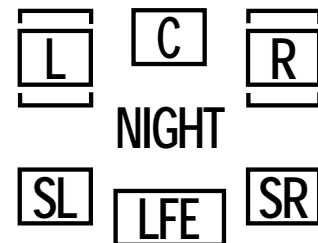

Figure 6

Configuring the Surround Off (Stereo) Modes

For superior reproduction of two-channel program materials, the AVR 225 offers two Stereo modes: an analog Stereo-Direct mode that bypasses the digital signal-processing circuitry for a completely analog signal path that preserves the purity of the original signal, and a digital mode that is capable of providing bass management for optimal distribution of the low frequencies between smaller speakers and a subwoofer.

Stereo-Direct (Bypass) Mode

When the analog Stereo-Direct mode is selected, either from the **SURROUND SETUP** menu (Figure 3) as described on page 18, or by pressing the **Surround Mode Selector 7** until **SURROUND OFF – STEREO** appears in the **Main Information Display S** and the **Surround Mode Indicator 29** for Surround Off is lit, the AVR 225 will pass the analog source material through to the front left and right speakers, bypassing the digital processing circuitry.

In this mode, the front left and right speakers will automatically be configured as **LARGE**, and it will not be possible to configure these speakers as **SMALL**.

You may configure the subwoofer as **ON** or **OFF** either by using the **SPEAKER SETUP** menu (Figure 5) as described on page 20, or by pressing the **Speaker Select Button 27** until **S-W SPEAKER** appears in the **Main Information Display S**. Press the **▲/▼ Buttons 13/17** or the **Selector Buttons 5** to select the desired option, and the **Set Button 21/15** to enter the selection.

Stereo-Digital Mode

If your front left and right speakers are not capable of handling a full-range input, you may prefer to take advantage of the AVR 225's bass management capability. Select Stereo-Digital mode in the **SURROUND SETUP** menu (Figure 3) as described on page 18, or press the **Surround Mode Selector 7** until **SURROUND OFF – A/D MODE** appears in the **Main Information Display S** and the **Surround Mode Indicator 29** for Surround Off is lit. In this mode, the analog input will be converted to digital and routed to the digital signal processor for bass management processing before it is converted back to analog and outputted to the front left and right speakers.

To configure your front left and right speakers in this mode, follow the procedure described on page 19 for configuring the Left and Right speakers using the **SPEAKER SETUP** menu (Figure 5), or press

the **Speaker Select Button 27** until **FNT SPKR** appears in the **Main Information Display S**, and then press the **Set Button 21/15**.

Press the **▲/▼ Buttons 13/17** or the **Selector Buttons 5** until either **LARGE** or **SMALL** appears, matching the type of speakers you have at the front-left and -right positions, as described on page 20.

When **SMALL** is selected, low-frequency sounds will be sent to the subwoofer output only, and the subwoofer speaker will automatically be configured as **ON**. If you choose the **SMALL** configuration and there is no subwoofer connected, you will not hear any low-frequency sounds.

When **LARGE** is selected, a full-range output will be sent to the front-left and front-right speakers, and NO low-frequency signals will be sent to the subwoofer output.

Output Level Adjustment

Output level adjustment is a key part of the configuration process for any surround sound product. It is particularly important for a Dolby Digital receiver such as the AVR 225, as correct outputs will ensure that you hear soundtracks in their proper place with the proper directionality and intensity.

IMPORTANT NOTE: Listeners are often confused about the operation of the surround channels. While some assume that sound should always be coming from each speaker, most of the time there will be little or no sound in the surround channels. This is because they are only used when a movie director or sound mixer specifically places sound there to create ambience, a special effect or to continue action from the front of the room to the rear. When the output levels are properly set, it is normal for surround speakers to operate only occasionally. Artificially increasing the volume to the rear speakers may destroy the illusion of an enveloping sound field that duplicates the way you hear sound in a movie theater or concert hall.

Before beginning the output level adjustment process, make certain that all speaker connections have been properly made. The system volume should be set to the level that you will use during a typical listening session. Finally, make certain that the **Balance Control 18** is set to the center "12 o'clock" position.

Using EzSet

Harman Kardon's exclusive EzSet remote makes it possible to quickly and accurately set the AVR 225's output levels without the use of a sound pressure meter, although manual adjustment is also available. However, for the easiest setup, follow these steps while seated in

the listening position that will be used most often:

1. If you have not done so previously, place the AVR 225 in Dolby Pro Logic II – Movie mode by using the **SURROUND SETUP** menu (Figure 3) as described on page 18. Output level adjustment using the test tone is not available in the Stereo modes. However, in the Stereo-Digital mode, you may trim the output levels using program material, as described on page 29.
2. Make certain that all speaker positions have been properly configured for their "large" or "small" settings (as outlined on page 19) and turn off the OSD system if it is in use.
3. Adjust the volume so that it is at **-1.5dB**, as shown in the on-screen display or **Main Information Display S**.
4. Hold the remote in front of you at arm's length, being sure not to cover the **EzSet Sensor Microphone 49** at the top of the remote.
5. Press and hold the **SPL Button 46** for three seconds. Release the button when the **Program/SPL Indicator 3** stops flashing and you hear the test noise from the front left speaker.
6. At this point, the EzSet circuitry will take over, adjusting the output level of each channel so that when the process is complete all levels will be equal and at the set reference point. This process may take a few minutes, depending on the extent of adjustment required.
7. During the adjustment process, you will see the location of the channel position being adjusted appear in both the on-screen display (if connected) and the **Main Information Display S**, alternating with a readout of the output setting, relative to the reference volume level. As the adjustment proceeds, a few things will happen simultaneously:
 - The channel position being adjusted will flash in the **Speaker/Channel Input Indicators L**. If the test noise is heard from a channel other than the one shown in the indicator, there is an error in the speaker connections. If this is the case, press the **Test Button 8** TWICE to stop the adjustment. Then, turn the unit off and verify that all speakers are connected to the proper **Outputs 14/15**.
 - As each channel is set, the channel name and the adjustment offset will appear in the on-screen display (if connected) and the **Main Information Display S**. While the level is changing, the **Program/SPL Indicator 3** will change colors to reflect the output level in rela-

SYSTEM CONFIGURATION

tion to the reference. A red indication shows that the level is too high, while an amber indication shows that the level is too low. When the indicator is green, the level is correct, and the test noise will move to the next channel. The color changes are for your information, but you do not need to adjust anything, as EzSet will do all the work.

- While adjustments are being made, the red LED under the **AVR Selector 6** will flash. This is normal, and indicates that EzSet is operating.
8. After the test noise has circulated once through each channel, it will send the tone to each channel once again, to verify the settings.
 9. After two complete circulations of the tone, the levels are set. The **Program/SPL Indicator 3** will remain green at each channel. Upon completion of the second circulation, the Program/SPL indicator will flash green twice and then go out. The tone will stop and the AVR 225 will return to normal operation.

If you find that the output levels chosen by EzSet are either uncomfortably low or high, you may repeat the procedure. Return to Step 3 above and set the master volume either slightly higher or lower to accommodate your particular room layout and your tastes. You may repeat this procedure as many times as necessary to achieve a desired result. In order to prevent possible damage to your hearing or your equipment, we emphasize that you should avoid setting the master volume above 0dB.

Manual Output Level Adjustment

Output levels may also be adjusted manually, either to set them to a specific level with an SPL meter, or to make fine-tuning adjustments to the levels obtained using the EzSet remote.

1. If you have not done so previously, place the AVR 225 in Dolby Pro Logic II – Movie mode by using the **SURROUND SETUP** menu (Figure 3) as described on page 18. Output level adjustment using the test tone is not available in the Stereo modes. However, in the Stereo-Digital mode, you may trim the output levels using program material, as described on page 29.
2. Manual output level adjustment is most easily done through the **OUTPUT ADJUST** menu (Figure 7). If you are already at the **MASTER MENU**, press the **▼ Button 17** until the on-screen ► cursor is next to the **OUTPUT ADJUST** line. If you are not at the **MASTER MENU**, press the **OSD Button 22** to bring up the **MASTER MENU** (Figure 1), and then press the **▼ Button 17** until the

on-screen ► cursor is next to the **OUTPUT ADJUST** line. Press the **Set Button 15** to bring the **OUTPUT ADJUST** menu (Figure 7) to the screen.

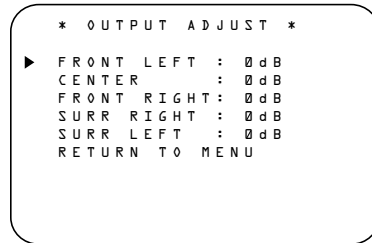

Figure 7

3. As soon as the new menu appears, you will hear a test noise circulate from speaker to speaker in a clockwise direction around the room. The test noise will play for three seconds in each speaker before circulating, and a blinking on-screen cursor will appear next to the name of each speaker location when the sound is at that speaker.

NOTE: This is a good time to verify that the speakers have been properly connected. As the test noise circulates, listen to make certain that the sound comes from the speaker position shown in the **Main Information Display S**. If the sound from a speaker location does NOT match the position indicated in the display, turn the AVR 225 off using the **Main Power Switch 1** and check the speaker wiring to make certain that each speaker is connected to the correct output terminal.

4. After checking for speaker placement, let the test noise circulate again, and listen to see which channels sound louder than the others. Using the front left (**FL** in the display) speaker as a reference, press the **◀▶ Buttons 14 31** on the remote for each channel to bring them to the same level. Note that when one of the **◀▶** buttons is pushed, the test noise circulation will pause on the channel being adjusted to give you time to make the adjustment. When you release the button, the circulation will resume after 15 seconds.
5. Continue to adjust the individual channels until the volume level sounds the same from each speaker. Note that adjustments should be made with the **◀▶ Buttons 14 31** on the remote only, NOT the main volume controls. If you are using a sound pressure level (SPL) meter for precise level adjustment, set the volume so that the meter reads 75dB, C-Weighting Slow.
6. You may also adjust the output levels manually while using the level indication feature of the EzSet

remote. To activate the sensor and indicator, simply press and release the **SPL Button 36** on the remote while the test tone is circulating. The **Program/SPL Indicator 3** will change color to indicate the level. Adjust the level using the **◀▶ Buttons 14 31** until the LED lights green for all channels. When it is red the level is too high; when it is amber the level is too low. Press the **SPL Button 36** when you are finished to turn the sensor and indicator off.

NOTE: The subwoofer output level is not adjustable using the test tone. To change the subwoofer level, follow the steps for Output Level Trim Adjustment on page 29.

7. When all channels have an equal volume level, the adjustment is complete. To exit this menu, press the **▲/▼ Buttons 13 17** until the on-screen ► cursor is next to the **RETURN TO MENU** line, and then press the **Set Button 15** to return to the **MASTER MENU**.

The output levels may also be adjusted at any time using the discrete buttons and Semi-OSD system. To adjust the output levels in this fashion, press the **Test Tone Selector 28 8**. As soon as the button is pressed, the test tone will begin to circulate as indicated earlier. The correct channel from which the test noise should be heard will be shown in the lower third of the video screen and in the **Main Information Display S**. While the test noise is circulating, the proper channel position will also be indicated in the **Speaker/Channel Input Indicators L** by a blinking letter within the correct channel.

To adjust the output level, press the **Selector Buttons 5** on the front panel or the **◀▶ Buttons 14 31** until the desired level is shown in the display or on-screen. Once the buttons are released, the test noise will begin to circulate again in 15 seconds.

When all channels have the same output level, press the **Test Tone Selector Button 28 8** again to complete the process.

NOTE: Output level adjustment is not available for the VMaX or Surround Off modes. However, the levels of the left and right channels in the Surround Off (Stereo) modes may be adjusted relative to each other using the **Balance Control 18**.

Additional Input Adjustments

After one input has been adjusted for surround mode, digital input (if any), speaker type and output levels, go back to the **INPUT SETUP** line on the **MASTER MENU** and enter the settings for each input that you will use. In most cases, only the digital

input and surround mode will be different from one input to the next, while the speaker type, night mode and output level settings will usually be the same and may be quickly entered by entering the same data used for the original input.

Once the settings outlined on the previous pages have been made, the AVR 225 is ready for operation. While there are some additional settings to be made, these are best done after you have had an opportunity to listen to a variety of sources and different kinds of program material. These advanced settings are described on pages 30–31 of this manual. In addition, any of the settings made in the initial configuration of the unit may be changed at any time. As you add new or different sources or speakers, or if you wish to change a setting to better reflect your listening taste, simply follow the instructions for changing the settings for that parameter as shown in this section.

Having completed the setup and configuration process for your AVR 225, you are about to experience the finest in music and home theater listening. Enjoy!

OPERATION

Basic Operation

Once you have completed the setup and configuration of the AVR 225, it is simple to operate and enjoy. The following instructions will help you maximize the enjoyment of your new receiver:

Turning the AVR 225 On or Off

- When using the AVR 225 for the first time, you must press the **Main Power Switch 1** on the front panel to turn the unit on. This places the unit in a Standby mode, as indicated by the amber color of the **Power Indicator 3**. Once the unit is in Standby, you may begin a listening session by pressing the **System Power Control 2** on the front panel or the **AVR Selector 6**. The **Power Indicator 3** will turn green. This will turn the unit on and return it to the input source that was last used. The unit may also be turned on from Standby by pressing any of the **Input Selector Buttons 5 6 7 37** on the remote or the **Input Source Selector 11** on the front panel.

NOTE: After pressing one of the **Input Selector Buttons 5 7 37** to turn the unit on, press the **AVR Selector 6** to set the remote control to the AVR 225's functions.

To turn the unit off at the end of a listening session, simply press the **System Power Control 2** on the front panel or the **Power Off Button 1** on the remote. Power will be shut off to any equipment plugged into the rear-panel **Switched AC Outlet 14** and the **Power Indicator 3** will turn amber.

When the remote is used to turn the unit "off" it is actually placing the system in a Standby mode, as indicated by the amber color of the **Power Indicator 3**.

- To program the AVR 225 for automatic turn-off, press the **Sleep Button 9** on the remote. Each press of the button will decrease the time before shutdown in the following sequence:

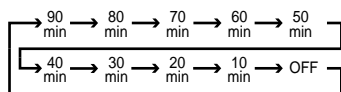

The sleep time will be displayed in the **Preset Number/Sleep Timer Indicator J** and it will count down until the time has elapsed.

When the programmed sleep time has elapsed, the unit will automatically turn off. Note that the front-panel display will dim to one-half brightness when the Sleep function is programmed. To cancel the Sleep function, press and hold the **Sleep Button 9** until the information display returns to normal brightness, the Sleep indicator numbers disappear and **SLEEP 0** appears in the **Main Information Display S**.

When you will be away from home for an extended period of time it is always a good idea to completely turn the unit off with the front-panel **Main Power Switch 1**.

NOTE: All preset memories are lost if the unit is left turned off by using the **Main Power Switch 1** for more than one week.

Source Selection

- To select a source, press any of the **Source Selector Buttons 5 7 37** on the remote.

- The input source may also be changed by pressing the front-panel **Input Source Selector 11**. Each press of the button will move the input selection through the list of available inputs.

- As the input is changed, the AVR 225 will automatically switch to the digital input (if selected), surround mode, speaker configuration, output levels, crossover frequency and night mode status that were entered during the configuration process for that source.

- The front-panel **Video 4 Inputs 15 16** may be used to connect a device such as a video game or camcorder to your home entertainment system on a temporary basis.

- As the input source is changed, the new input name will appear momentarily as an on-screen display in the lower third of the video display. The input name will also appear in the **Main Information Display S** and a green LED will light next to the selected input's name in the front-panel **Input Indicators 22**.

- When an audio source is selected, the last video input used remains routed to the **Video Outputs 23 26 34 38** and **Video Monitor Outputs 19 29**. This permits simultaneous viewing and listening to different sources.

- When a Video source is selected, the video signal for that input will be routed to the **Video Monitor Output Jacks 19 29** and will be viewable on a TV monitor connected to the AVR 225.

Volume Control

- Adjust the volume to a comfortable level using the front-panel **Volume Control 20** or remote **Volume Up/Down 34** buttons.

- When listening in one of the Stereo modes with the surround circuits off, the **Balance Control 18** may be used to adjust the relative sound output between the front left and right speakers.

- To temporarily silence all speaker outputs press the **Mute Button 38**. This will interrupt the output to all speakers and the headphone jack, but it will not affect any recording or dubbing that may be in progress. Press the **Mute Button 38** again or adjust the volume to return to normal operation.

- During a listening session you may wish to adjust the **Bass Control 17** and **Treble Control 19** to suit your listening tastes or room acoustics.

- To set the output of the AVR 225 so that the output is "flat," with the tone controls deactivated, press the **Tone Mode Button 6** until the words **Tone Out** appear momentarily in the **Main Information Display S**. To return the tone controls to an active condition, press the **Tone Mode Button 6** until the words **Tone In** momentarily appear in the **Main Information Display S**.

- For private listening, plug the 1/4" stereo phone plug from a pair of stereo headphones into the front-panel **Headphone Jack 4**. Note that when the headphone's plug is connected, the words **HEADPHONE IN** will scroll once across the **Main Information Display S** and all speakers will be silenced. When the headphone plug is removed, the audio feed to the speakers will be restored.

Surround Mode Chart

MODE	FEATURES	DELAY TIME RANGE
Dolby Digital	Available only with digital input sources encoded with Dolby Digital data. It provides up to five separate main audio channels and a special dedicated Low-Frequency Effects channel.	Center: 0ms – 5ms Initial Setting: 0ms Surround: 0ms – 15ms Initial Setting: 0ms
DTS	Available only with digital input sources encoded with DTS data. Available on special DVD, LD and audio-only discs, DTS provides up to five separate main audio channels and a special dedicated low-frequency channel.	Delay time not adjustable
Dolby Pro Logic II Movie Music Emulation	Dolby Pro Logic II is the latest version of Dolby Laboratory's benchmark surround technology that decodes full-range, discrete left, center right, right surround and left surround channels from matrix surround-encoded programs and conventional stereo sources. The Dolby Pro Logic II Movie mode is optimized for movie soundtracks, while the Pro Logic II Music mode should be used with musical selections. The Pro Logic II Emulation mode re-creates original Pro Logic processing for those who prefer that presentation.	15ms – 30ms Initial Setting: 15ms
Logic 7 C Logic 7 M	Logic 7 is an advanced mode that extracts the maximum surround information from either surround-encoded programs or conventional stereo material. The Logic 7 C (or Cinema) mode should be used with any source that contains Dolby Surround or similar matrix encoding. Logic 7 C delivers increased center-channel intelligibility, and more accurate placement of sounds with fades and pans that are much smoother and more realistic than with other decoding techniques. The Logic 7 M (or Music) mode should be used with analog or PCM stereo sources. Logic 7 M enhances the listening experience by presenting a wider front soundstage and greater rear ambience. Both Logic 7 modes also direct low-frequency information to the subwoofer (if installed and configured) to deliver maximum bass impact.	Delay time not adjustable
Dolby 3 Stereo	Uses the information contained in a surround-encoded or two-channel stereo program to create center-channel information. In addition, the information that is normally sent to the rear-channel surround speakers is carefully mixed in with the front-left and front-right channels for increased realism. Use this mode when you have a center channel speaker but no surround speakers.	No surround channels
Theater	The Theater mode creates a sound field that resembles the acoustic feeling of a standard live performance theater.	Delay time not adjustable
Hall 1 Hall 2	The two Hall modes create sound fields that resemble a small (Hall 1) or medium-sized (Hall 2) concert hall.	Delay time not adjustable
VMAx Near VMAx Far	When only the two front-channel loudspeakers are used, Harman's patented VMAx mode delivers a three-dimensional sound space with the illusion of "phantom speakers" at the center and surround positions. The VMAx N (or "Near Field") mode should be selected when your listening position is less than five feet from the speakers. The VMAx F (or "Far Field") mode should be selected when your listening position is greater than five feet from the speakers. The VMAx modes are also available using the Headphones Output 4 . When headphones are being used, the Far Field mode will appear to push the sound field away from your ears, reducing the "inside the head" sensation often experienced when using headphones.	No surround channels
5-Channel Stereo	This mode takes advantage of multiple speakers to place a stereo signal at both the front and back of a room. Ideal for playing music in situations such as a party, it places the same signal at the front-left and surround-left, and front-right and surround-right speakers. The center channel is fed a summed mono mix of the in-phase material of the left and right channels.	No delay is available for this mode
Surround Off (Stereo) Stereo-Direct (Bypass) Stereo-Digital	These modes turn off all surround processing and present the pure left- and right-channel presentation of two-channel stereo programs. The Stereo-Direct (Bypass) mode may only be used with analog source inputs, as it preserves the analog format of the audio signal for its entire path of travel through the receiver to the speaker and subwoofer outputs, bypassing all digital processing. Digital bass management is not available in Stereo-Direct mode. The Stereo-Digital mode can be used with either an analog or digital input, as the signal undergoes digital bass management to optimize the distribution of the low frequencies between the main speakers and a subwoofer.	No surround channels

Surround Mode Selection

One of the most important features of the AVR 225 is its ability to reproduce a full multichannel surround sound field from digital sources, analog matrix surround-encoded programs and standard stereo programs. In all, a total of 16 listening modes are available on the AVR 225.

Selection of a surround mode is based on personal taste, as well as the type of program source material being used. For example, motion pictures or TV programs bearing the logo of one of the major surround-encoding processes, such as Dolby Surround[®]*, DTS Stereo[®]* or UltraStereo[™]* may be played in either the Dolby Digital, Dolby Pro Logic II or Logic 7 Cinema surround modes, depending on the source material.

NOTE: Once a program has been encoded with matrix surround information, it retains the surround information as long as the program is broadcast in stereo. Thus, movies with surround sound may be decoded via any of the analog surround modes such as Pro Logic II or Logic 7, when they are broadcast via conventional TV stations, cable, pay TV and satellite transmission. In addition, a number of made-for-television programs, sports broadcasts, radio dramas and music CDs are also recorded in surround sound. You may view a list of these programs at www.dolby.com.

Even when a program is not listed as carrying intentional surround information, you may find that the Pro Logic II, Logic 7, VMaX and the Hall or Theater modes often deliver enveloping surround presentations through the use of the natural information present in all stereo recordings. However, for stereo, but not surround programs, we suggest that you experiment with the other modes.

Surround modes are selected using either the front-panel controls or the remote. To select a surround mode from the front panel, press the **Surround Mode Selector 7** to scroll up or down through the list of available modes. To select a surround mode using the remote, press the **Surround Mode Selector 10** and then press the **▲/▼ Buttons 13 17** to change the mode. As you press the buttons, the Surround mode name will appear in the lower third of the on-screen display and in the **Main Information Display S**, and an individual mode indicator will also light up **BIC DEGHI**. As the surround modes change, a green LED will light next to the current mode in the **Surround Mode Indicators 29** list on the front panel.

NOTE: The name of each **Surround Mode** will scroll across the bottom of the on-screen display and through the **Main Information Display S** while the modes are being selected. To avoid exiting from the surround mode selection process, push the **▲** or **▼ Button 13 17** while a mode name is still visible.

Note that the Dolby Digital and DTS modes may only be selected when a digital input is in use. In addition, when a digital source is present, the AVR 225 will automatically select and switch to the correct mode (Dolby Digital or DTS), regardless of the mode that has been previously selected. For more information on selecting digital sources, see the following section of this manual.

To listen to a program in traditional two-channel stereo, using the front-left and front-right speakers only (plus the subwoofer if installed and configured), follow the instructions shown above for using the remote until **SURR OFF** appears in the **Main Information Display S**. Note that the Stereo-Direct (Bypass) mode may only be selected when an analog input is in use.

Digital Audio Playback

Digital audio is a major advancement over older analog matrix surround systems. It delivers five discrete channels: left-front, center, right-front, left-surround and right-surround. Each channel reproduces full frequency range (20Hz to 20kHz) and offers dramatically improved dynamic range and significant improvements to signal-to-noise ratios. In addition, digital systems have the capability to deliver an additional channel that is specifically devoted to low-frequency information. This is the ".1" channel referred to when you see these systems described as "5.1". The bass channel is separate from the other channels, but since it is intentionally bandwidth-limited, sound designers have given it that unique designation.

Dolby Digital

Dolby Digital (originally known as AC-3[®]) is a standard part of the DVD format, and is also part of the new digital broadcasting system and it is available with many satellite receivers and some digital cable boxes, as well as with specially encoded LD discs.

Note that an optional, external RF demodulator is required to use the AVR 225 to listen to the Dolby Digital soundtracks available on laser discs. Connect the RF output of the LD player to the demodulator and then connect the digital output of the demodulator to the **Optical or Coaxial Inputs 21 24 13 14** of the AVR 225. No demodulator is required for use with DVD players or DTS-encoded laser discs.

DTS

DTS is another digital audio system that is capable of delivering 5.1 audio. Although both DTS and Dolby Digital are digital, they use different methods of encoding the signals, and thus they require different decoding circuits to convert the digital signals back to analog.

DTS-encoded soundtracks are available on select DVD and LD discs, as well as on special audio-only DTS

discs. You may use any LD or CD player equipped with a digital output to play DTS-encoded discs with the AVR 225. All that is required is to connect the player's output to either the **Optical or Coaxial** input on the rear panel **21 24** or front panel **13 14**.

In order to listen to DVDs encoded with DTS soundtracks, the DVD player must be compatible with the DTS signal as indicated by a DTS logo on the player's front panel. Early DVD players may not be able to play DTS-encoded DVDs. This does not indicate a problem with the AVR 225, as some players cannot pass the DTS signal through to the digital outputs. If you are in doubt as to the capability of your DVD player to handle DTS discs, consult the player's owner's manual. Please note that some DVD players are shipped with their output set for Dolby Digital only. To ensure that DTS data is being sent to the AVR, please check the setup menu system on your DVD player to make certain that DTS data output is enabled.

Selecting a Digital Source

To utilize either digital mode you must have properly connected a digital source to the AVR 225. Connect the digital outputs from DVD players, HDTV receivers, satellite systems or CD players to the **Optical or Coaxial Inputs 21 24 13 14**. In order to provide a backup signal and a source for analog stereo recording, the analog outputs provided on digital source equipment should also be connected to their appropriate inputs on the AVR 225 rear panel (e.g., connect the analog stereo audio output from a DVD to the **DVD Audio Inputs 31** on the rear panel when you connect the source's digital outputs).

When playing a digital source such as DVD, first select the input using the remote or front-panel controls as described on page 17. Next, select the digital source by pressing the **Digital Input Selector Button 16 24** and then using the **▲/▼ Buttons 13 17** on the remote or the **Selector Buttons 5** on the front panel to choose any of the optical or coaxial inputs, as they appear in the **Main Information Display S**, the **Digital Input Indicators UV** or the on-screen display. Alternatively, you may use the **INPUT SETUP** menu (Figure 2) to select among the digital or analog inputs as described on pages 17–18. When the digital source is playing, the AVR 225 will automatically detect whether it is a multi-channel Dolby Digital or DTS source, or a conventional PCM signal, which is the standard output from CD players. A **Bitstream Indicator A** will light in the **Main Information Display 25** to confirm that the digital signal is Dolby Digital, DTS or PCM.

Digital Status Indicators

When a digital source is playing, the AVR 225 senses the type of bitstream data that is present. Using this information, the correct surround mode will automatically be selected. For example, DTS bitstreams will cause the unit to switch to DTS decoding, and Dolby Digital bitstreams will enable Dolby Digital decoding. When the unit senses PCM data from CDs or LDs, you may select any of the standard surround modes, such as Dolby Pro Logic II or Logic 7. Since the range of available surround modes is dependent on the type of digital data that is present, the AVR 225 uses a variety of indicators to let you know what type of signal is present. This will help you to understand the choice of modes.

When a digital source is playing, a **Bitstream Indicator** **A** will light to show which type of signal is playing:

DD: When the DOLBY D indicator lights, a Dolby Digital bitstream is being received. Depending on the settings on the source player and specific surround information and number of channels on the disc, a number of surround modes are possible. For discs with full 5.1 audio, only the Dolby Digital and VMAx modes are available. When the Dolby Digital signal is only two-channel, you may also select from the Logic 7 Cinema/Music, Hall 1/2, Theater, Dolby Pro Logic II Movie, Music or Emulation, or Dolby 3 Stereo modes. When the AVR 225 senses a 2.0-channel Dolby Digital signal, the unit will automatically select Dolby Pro Logic II as the surround processing mode, and both the **Dolby Digital** **C** and **Dolby Pro Logic II** **D** indicators will light in accordance with the requirements of Dolby Laboratories.

DTS: When the DTS indicator lights, a DTS bitstream is being received. When the unit senses this type of data, only the DTS mode may be used.

PCM: When the PCM indicator lights, a standard Pulse Code Modulation, or PCM, signal is being received. This is the type of digital audio used by conventional compact disc and laser disc recordings. When a PCM bitstream is present, all modes except Dolby Digital and DTS are available.

When a high-resolution, 96kHz/24-bit PCM signal is detected, the current source input followed by **96k** (for example, **DVD / 96k**) will be displayed in the **Main Information Display** **S**. This type of program material can be found on specially marked discs that were recorded using a higher sampling rate than the 44kHz or 48kHz typically used on compact discs. The Stereo-Digital (Surround Off) mode will be available to process a 96/24 signal. The Stereo-Analog mode will not be available since, by definition, a 96/24 signal may be supplied only via a digital input.

In addition to the bitstream indicators, the AVR 225 features a set of unique channel-input indicators that tell you how many channels of digital information are being received and/or whether the digital signal is interrupted.

These indicators are the L/C/R/LS/RS/LFE letters that are inside the center boxes of the **Speaker/Channel Input Indicators** **L** in the front-panel **Main Information Display** **25**. When a standard analog signal is in use, only the "L" and "R" indicators will light, as analog signals have only left and right channels.

Digital signals, however, may have two, five or six separate channels, depending on the program material, the method of transmission and the way in which it was encoded. When a digital signal is playing, the letters in these indicators will light in response to the specific signal being received. It is important to note that although Dolby Digital, for example, is referred to as a "5.1" system, not all Dolby Digital DVDs or programs are encoded with 5.1 channels. Thus, it is sometimes normal for a DVD with a Dolby Digital soundtrack to trigger only the "L" and "R" indicators.

NOTE: Many DVD discs are recorded with both "5.1" and "2.0" versions of the same soundtrack. When playing a DVD, always be certain to check the type of material on the disc. Most discs show this information in the form of a listing or icon on the back of the disc jacket. When a disc does offer multiple soundtrack choices, you may have to make some adjustments to your DVD player (usually with the "Audio Select" button or in a menu screen on the disc) to send a full 5.1 feed to the AVR 225. It is also possible for the type of signal feed to change during the course of a DVD playback. In some cases the previews of special material will only be recorded in 2.0 audio, while the main feature is available in 5.1 audio. As long as your DVD player is set for 6-channel output, the AVR 225 will automatically sense changes to the bitstream and channel count and reflect them in these indicators.

The letters used by the **Speaker/Channel Input Indicators** **L** also flash to indicate when a bitstream has been interrupted. This will happen when a digital input source is selected before the playback starts, or when a digital source such as a DVD is paused. The flashing indicators remind you that the playback has stopped due to the absence of a digital signal and not through any fault of the AVR 225. This is normal, and the digital playback will resume once the playback is started again.

Night Mode

A special feature of Dolby Digital is the Night mode, which enables AC-3 input sources to be played back with full dialogue intelligibility while reducing the mini-

mum peak level by $\frac{1}{4}$ to $\frac{1}{3}$. This prevents abruptly loud transitions from disturbing others, without reducing the impact of the digital source. The Night mode is available only when Dolby Digital signals with special data are being played.

The Night mode may be engaged when a Dolby Digital DVD is playing by pressing the **Night Mode Button** **11** on the remote. Next, press the **▲/▼ Buttons** **13 17** to select either the middle range or full-compression versions of the Night mode. To turn the Night mode off, press the **▲/▼ Buttons** **13 17** until the message in the lower third of the video display and the **Main Information Display** **S** reads **D - R O f f**. When the Night mode is active, the **Night Mode Indicator** **K** will also light.

The Night mode may also be selected to always be on at either level of compression using the options in the **SURROUND SETUP** menu (Figure 4). See page 19 for information on using the menus to set this option.

IMPORTANT NOTES ON DIGITAL PLAYBACK:

1. When the digital playback source is stopped, or in a Pause, Fast Forward or Chapter Search mode, the digital audio data will momentarily stop, and the channel position letters inside the **Speaker/Channel Input Indicators** **L** will flash. This is normal and does not indicate a problem with either the AVR 225 or the source machine. The AVR 225 will return to digital playback as soon as the data is available and when the machine is in a standard play mode.
2. Although the AVR 225 will decode virtually all DVD movies, CDs and HDTV sources, it is possible that some future digital sources may not be compatible with the AVR 225.
3. Note that not all digitally encoded programs contain full 5.1-channel audio. Consult the program guide that accompanies the DVD or laser disc to determine which type of audio has been recorded on the disc. The AVR 225 will automatically sense the type of digital surround encoding used and adjust to accommodate it.
4. When a digital source is playing, you may not be able to select some of the analog surround modes such as Dolby Pro Logic II, Dolby 3 Stereo, Hall, Theater or Logic 7.
5. When a Dolby Digital or DTS source is playing, it is not possible to make an analog recording using the **Tape** **4** and **Video 1 or Video 2 Outputs** **23 26 34 35 38 39**. However, the digital signals will be passed through to the **Digital Audio Outputs** **17 18**.

OPERATION

PCM Audio Playback

PCM (Pulse Code Modulation) is the noncompressed digital audio system used for compact discs and laser discs. The digital circuits in the AVR 225 are capable of high-quality digital-to-analog decoding, and they may be connected directly to the digital audio output of your CD or LD player.

Connections may be made to either the rear-panel **Optical** or **Coaxial Inputs** 21/24 or the front-panel **Digital Inputs** 13/14.

To listen to a PCM digital source, first select the input for the desired source (e.g., CD). Next, press the **Digital Input Selector** 24/16 and then use the **Left/Right Buttons** 14/17 on the remote, or the **Selector Buttons** 5 on the front panel, until the desired choice appears in the **Main Information Display** S.

When a PCM source is playing, the **PCM Indicator** A will light. During PCM playback, you may select any Surround mode except Dolby Digital or DTS.

If a 96kHz/24-bit PCM signal is detected, the current source input followed by 96k (for example, DVD / 96k) will be displayed in the **Main Information Display** S. You may select the Stereo-Digital (Surround Off) mode to process this type of signal.

Playback from PCM sources may also benefit from the Logic 7 mode. When playing back a surround-encoded PCM source, such as an LD or surround-encoded CD, use the Logic 7 C (or Cinema) mode. When playing true stereo recordings, use the Logic 7 M (or Music) mode for a wider soundstage and increased rear-channel ambience.

NOTE: When a Logic 7 mode is in use with a Dolby Digital 2.0 digital input source, that mode, rather than Logic 7, will be used by the AVR after the digital bit-stream is interrupted for any reason, such as stopping or pausing the digital playback. Note, also, that Logic 7 is not available with digital playback unless a two-channel bitstream is in use.

Tuner Operation

The AVR 225's tuner is capable of tuning AM, FM and FM Stereo broadcast stations. Stations may be tuned manually, or they may be stored as favorite station presets and recalled from a 30-position memory.

Station Selection

1. Press the **AM/FM Tuner Select Button** 7 on the remote to select the tuner as an input. The tuner may be selected from the front panel either by pressing the **Input Source Selector** 11 until the tuner is active or by pressing the **AM/FM Band Selector** 9 at any time.

2. Press the **AM/FM Tuner Select Button** 7 or **AM/FM Band Selector** 9 again to switch between AM and FM so that the desired frequency band is selected.

3. Press the **Tuning Mode Button** 12/19 to select manual or automatic tuning.

In automatic tuning mode, the **AUTO Indicator** R is illuminated in the **Main Information Display** 25 and the tuner will stop only at those stations that have a signal that's strong enough to be received with acceptable quality.

When the **Auto Indicator** R is not illuminated, the tuner is in a manual mode and will stop at each frequency increment in the selected band.

4. To select stations, press the **Tuning Selector Button** 8/21. When the **Auto Indicator** R is illuminated, press the button and then release to cause the tuner to search for the next highest- or lowest-frequency station that has an acceptable signal. When tuning FM stations in the Auto mode, the tuner will select only stereo stations. To tune to the next station, press the button again. If the **Stereo Indicator** P is not illuminated, press the **Tuning Mode Button** 12/19 to activate manual mode and tap the **Tuning Selector Button** 8/21 to advance one frequency increment at a time, or press and hold it to locate a specific station. When the **Tuned Indicator** Q lights, the station is properly tuned and should be heard with clarity.

5. Stations may also be tuned directly in either automatic or manual tuning mode by pressing the **Direct Button** 20, and then pressing the **Numeric Keys** 18 that correspond to the station's frequency. The desired station will automatically be tuned. If you press an incorrect button while entering a direct frequency, press the **Clear Button** 28 to start over.

NOTE: When the FM reception of a station is weak, audio quality will be increased by switching to Mono mode by pressing the **Tuning Mode Button** 12/19 until the **Stereo Indicator** P goes out. This will also activate the manual tuning mode.

Preset Tuning

Using the remote, up to 30 stations may be stored in the AVR 225's memory for easy recall using the front-panel controls or the remote.

To enter a station into the memory, first tune the station using the steps outlined above. Then:

1. Press the **Memory Button** 29 on the remote. The **Memory Indicator** O will be illuminated and flash in the **Main Information Display** 25.

2. Within five seconds, press the **Numeric Keys** 18 corresponding to the location where you wish to store this station's frequency. Once entered, the preset number will appear in the **Preset Number/Sleep Time Display** J.

3. Repeat the process after tuning any additional stations to be preset.

Recalling Preset Stations

- To manually select a station previously entered in the preset memory, press the **Numeric Keys** 18 that correspond to the desired station's memory location.

- To manually tune through the list of stored preset stations one by one, press the **Preset Stations Selector Buttons** 10/27 on the front panel or remote.

Tape Recording

In normal operation, the audio or video source selected for listening through the AVR 225 is sent to the record outputs. This means that any program you are watching or listening to may be recorded simply by placing machines connected to the outputs for **Tape Outputs** 4 or **Video 1 or 2 Outputs** 23/25/34/35/38/39 in the record mode.

When a digital audio recorder is connected to the **Optical** 17 or **Coaxial** 18 digital audio outputs, you may record the digital signal using a CD-R, MiniDisc or other digital recording system.

NOTES:

- The AVR 225 converts analog inputs to a PCM digital signal, enabling you to record the material on a CD or MD recorder connected to one of the AVR 225's **Digital Audio Outputs** 17/18. The digital recorder must be compatible with the output signal. For example, the PCM digital input from a CD player may be recorded on a CD-R or MiniDisc, but Dolby Digital or DTS signals may not.

- Please make certain that you are aware of any copyright restrictions on any material you copy. Unauthorized duplication of copyrighted materials is prohibited by federal law.

Output Level Trim Adjustment

Normal output level adjustment for the AVR 225 is established using the test tone, as outlined on pages 21 and 22. In some cases, however, it may be desirable to adjust the output levels using program material such as a test disc, or a selection you are familiar with. Additionally, the output level for the subwoofer can only be adjusted using this procedure.

To adjust the output levels using program material, first set the reference volume for the front-left and front-right channels using the **Volume Control 20 34**.

If you are using a disc with test signals or an external signal generator as the source from which to trim the output levels, you may use the EzSet feature of the remote to guide you to the reference SPL level. To use the remote for this purpose, press and quickly release the **SPL Button 36** to activate the sensor. While the test tone is circulating, the **Program/SPL Indicator 3** will change color to indicate the level. Adjust the level as shown on pages 21 and 22 until the LED lights green for all channels. When it is red the level is too high; when it is amber the level is too low. Press the **SPL Button 36** to turn the sensor and indicator off.

Once the reference level has been set, press the **Channel Select Button 12 26** and note that **FL LEVEL** will appear in the **Main Information Display S**. To change the level, first press the **Set Button 15 21**, and then use the **Selector Buttons 5** or the **▲/▼ Buttons 13 17** to raise or lower the level. DO NOT use the volume control, as this will alter the reference setting.

Once the change has been made, press the **Set Button 15 21** and then press the **Selector Buttons 5** or the **▲/▼ Buttons 13 17** to select the next output channel location that you wish to adjust. To adjust the subwoofer level, press the **Selector Buttons 5** or the **▲/▼ Buttons 13 17** until **SW LEVEL** appears in the **Main Information Display S** or on-screen display.

Press the **Set Button 15 21** when the name of the desired channel appears in the **Main Information Display S** and on-screen display, and follow the instructions shown earlier to adjust the level.

Repeat the procedure as needed until all channels requiring adjustment have been set. When all adjustments have been made and no further adjustments are made for five seconds, the AVR 225 will return to normal operation.

The channel output for any input may also be adjusted using the Full-OSD on-screen menu system. First, set the volume to a comfortable listening level using the **Volume Control 20 34**. Then, press the **OSD Button 22** to bring up the **MASTER MENU** (Figure 1). Press the **▼ Button 17** until the on-screen **►** cursor is next to the **CHANNEL ADJUST** line. Press the **Set Button 15** to activate the **CHANNEL ADJUST** menu (Figure 8).

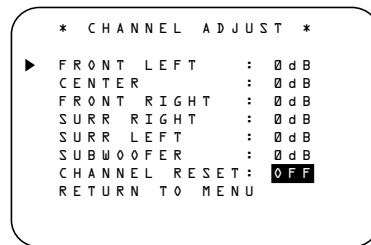

Figure 8

Once the menu appears on your video screen, use the **▲/▼ Buttons 13 17** to move the on-screen **►** cursor so that it is next to the channel that you wish to adjust. Then, use the **◀/▶ Buttons 14 31** to raise or lower the output level. Remember, the goal is to have the output level at each channel be equal when heard at the listening position.

When all adjustments are done, press the **▲/▼ 13 17** buttons to move the on-screen **►** cursor so that it is next to **RETURN TO MENU** and then press the **Set Button 15** if you wish to go back to the main menu to make other adjustments. If you have no other adjustments to make, press the **OSD Button 22** to exit the menu system.

NOTES:

- The output levels may be separately trimmed for each digital and analog surround mode. If you wish to have different trim levels for a specific mode, select that mode and then follow the instructions in the steps shown earlier.
- In Stereo-Digital (Surround Off) mode, only the front-left, front-right and subwoofer channels may be trimmed. It is not possible to trim the output levels in Stereo-Direct mode, since that mode bypasses the digital circuitry used for output-level trimming.

6-Channel Direct Input

The AVR 225 is equipped for future expansion through the use of optional, external adapters for formats that the AVR 225 may not be capable of processing. When an adapter is connected to the **6-Channel Direct Inputs 28**, you may select it by pressing the **6-Ch Direct Input Selector 37**. The 6-Channel Direct input may also be selected by pressing the **Input Source Selector Button 11** on the front panel until **6 CH DIRECT** appears in the **Main Information Display S** and a green LED lights next to **6 CH** in the **Input Indicators 22**.

When the 6-Channel Direct input is in use, you may not select a surround mode, as the external decoder determines processing. In addition, there is no signal at the record outputs when the 6-Channel Direct input is in use.

Memory Backup

This product is equipped with a memory backup system that preserves the system configuration information and tuner presets if the unit is accidentally unplugged or subjected to a power outage. This memory will last for approximately one week, after which time all information must be reentered.

ADVANCED FEATURES

The AVR 225 is equipped with a number of advanced features that add extra flexibility to the unit's operation. While it is not necessary to use these features to operate the unit, they provide additional options that you may wish to use.

Display Brightness

The AVR 225's **Main Information Display 25** is set at a default brightness level that is sufficient for viewing in a normally lit room. However, in some home theater installations, you may wish to occasionally lower the brightness of the display, or turn it off completely.

To change the display brightness setting for a specific listening session, you will need to make an adjustment in the **ADVANCED SELECT** menu. To start the adjustment, press the **OSD Button 22** to bring the **MASTER MENU** to the screen. Press the **▼ Button 17** until the on-screen ► cursor is next to the **ADVANCED** line. Press the **Set Button 15** to enter the **ADVANCED SELECT** menu (Figure 9).

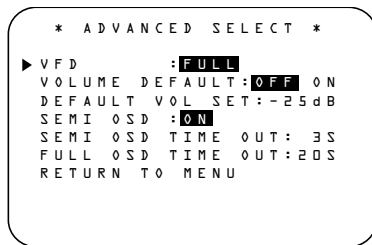

Figure 9

To change the brightness setting, at the **ADVANCED SELECT** menu, make certain that the on-screen ► cursor is next to the **VFD** line, and press the **► Button 31** until the desired brightness level is highlighted in the video display. When **FULL** is highlighted, the display is at its normal brightness. When **HALF** is highlighted, the display is at half the normal brightness level. When **OFF** is highlighted, all of the indicators in the **Main Information Display 25** will go dark. Note, however, that the green LEDs for the **Input Indicators 22** and the **Surround Mode Indicators 29**, as well as for the **Power Indicator 3**, will always remain lit to remind you that the unit is turned on.

The display brightness may also be changed by pressing and holding the **Set Button 21** on the front panel for three seconds until the message in the **Main Information Display 5** reads **VFD FULL**. Within five seconds, press the front-panel **Selector Buttons 5** until the desired brightness display level is shown. At that point, press the **Set Button 21** again to enter the setting.

Once the desired brightness level is selected, it will remain in effect until it is changed again or until the unit is turned off.

If you wish to make other adjustments, press the **▲/▼ Buttons 13 17** until the on-screen ► cursor is next to the desired setting or the **RETURN TO MENU** line and press the **Set Button 15**. If you have no other adjustments to make, press the **OSD Button 22** to exit the menu system.

Turn-On Volume Level

As is the case with most audio/video receivers, when the AVR 225 is turned on, it will always return to the volume setting in effect when the unit was turned off. However, you may prefer to always have the AVR 225 turn on at a specific setting, regardless of what was last in use when the unit was turned off. To change the default condition so that the same volume level is always used at turn-on, you will need to make an adjustment in the **ADVANCED SELECT** menu. To start the adjustment, press the **OSD Button 22** to bring the **MASTER MENU** (Figure 1) to the screen. Press the **▼ Button 17** until the on-screen ► cursor is next to the **ADVANCED** line. Press the **Set Button 15** to enter the **ADVANCED SELECT** menu (Figure 9).

At the **ADVANCED SELECT** menu make certain that the on-screen ► cursor is next to the **VOLUME DEFAULT** line by pressing the **▲/▼ Buttons 13 17** as needed. Next, press the **► Button 31** so that the word **ON** is highlighted in the video display. Next, press the **▼ Button** so that the on-screen ► cursor is next to the **DEFAULT VOL SET** line. To set the desired turn-on volume, press the **◀/▶ Buttons 14 31** until the desired volume level is shown on the **DEFAULT VOL SET** line. Note that this setting may NOT be made with the regular volume controls.

NOTE: Since the setting for the turn-on volume cannot be heard while the setting is being made, you may wish to determine the setting before making the adjustment. To do this, listen to any source and adjust the volume to the desired level using the regular **Volume Controls 20 34**. When the desired volume level to be used at turn-on is reached, make a note of the setting as it appears in the lower third of the video screen or in the **Main Information Display 5**. (A typical volume level will appear as a negative number such as -25dB.) When making the adjustment, use the **◀/▶ Buttons 14 31** to enter this setting.

Unlike some of the other adjustments in this menu, the turn-on volume default will remain in effect until it is changed or turned off in this menu, even when the unit is turned off.

If you wish to make other adjustments, press the **▲/▼ Buttons 13 17** until the on-screen ► cursor is next to the desired setting or the **RETURN TO MENU** line and press the **Set Button 15**. If you have no other adjustments to make, press the **OSD Button 22** to exit the menu system.

Semi-OSD Settings

The Semi-OSD system places one-line messages at the lower third of the video display screen whenever the Volume, Input Source, Surround mode or tuner frequency of any of the configuration settings is changed. The Semi-OSD system is helpful in that it enables you to have feedback on any control changes or remote commands using the video display when it is difficult to view the front-panel displays. However, you may occasionally prefer to turn these displays off for a particular listening session. You may also want to adjust the length of time the displays remain on the screen. Both of those options are possible with the AVR 225.

To turn off the Semi-OSD system, you will need to make an adjustment in the **ADVANCED SELECT** menu (Figure 9). To start the adjustment, press the **OSD Button 22** to bring the **MASTER MENU** to the screen. Press the **▼ Button** until the on-screen ▼ cursor is next to the **ADVANCED** line. Press the **Set Button 15** to enter the **ADVANCED SELECT** menu.

At the **ADVANCED SELECT** menu, make certain that the on-screen ► cursor is next to the **SEMI OSD** line by pressing the **▲/▼ Buttons 13 17** as needed. Next, press the **► Button 31** so that the word **OFF** is highlighted in the video display.

Note that this setting is temporary and will remain active only until it is changed or until the AVR 225 is turned off. Once the unit is turned off, the Semi-OSD displays will remain activated, even if they were switched off for the previous listening session.

To change the length of time that the Semi-OSD displays remain on the screen, go to the **ADVANCED SELECT** menu as outlined earlier, and press the **▲/▼ Buttons 13 17** as needed, until the on-screen ► cursor is next to the **SEMI OSD TIME OUT** line. Next, press the **◀/▶ Buttons 14 31** until the desired time in seconds is displayed. Note that, unlike most of the other options in this menu, this is a permanent setting change and the time-out entry will remain in effect until it is changed, even when the unit is turned off.

If you wish to make other adjustments, press the **▲/▼ Buttons 13 17** until the on-screen ► cursor is next to the desired setting or the **RETURN TO**

MENU line and press the **Set Button** **15**. If you have no other adjustments to make, press the **OSD Button** **22** to exit the menu system.

Full-OSD Time Out Adjustment

The Full-OSD menu system is used to simplify the setup and adjustment of the AVR 225 using a series of on-screen menus. The factory default setting for these menus leaves them on the screen for 20 seconds after a period of inactivity before they disappear from the screen or "Time Out." Time Out is a safety measure to prevent image retention of the menu text in your monitor or projector, which might happen if menus were left on indefinitely. However, some viewers may prefer a slightly longer or shorter period before the display times out.

To change the Full-OSD Time Out, you will need to make an adjustment in the **ADVANCED SELECT** menu (Figure 9). To start the adjustment, press the **OSD Button** **22** to bring the **MASTER MENU** to the screen. Press the **▼ Button** **17** until the on-screen **▼** cursor is next to the **ADVANCED** line. Press the **Set Button** **15** to enter the **ADVANCED SELECT** menu (Figure 9).

At the **ADVANCED SELECT** menu (Figure 9), make certain that the on-screen **▶** cursor is next to the **FULL OSD TIME OUT** line by pressing the **▲/▼ Buttons** **13 17** as needed. Next, press the **◀/▶ Buttons** **14 31** until the desired time is displayed in seconds. Note that unlike most of the other options in this menu, this is a permanent setting change, and the Time Out entry will remain in effect until it is changed, even if the unit is turned off.

If you wish to make other adjustments, press the **▲/▼ Buttons** **13 17** until the on-screen **▶** cursor is next to the desired setting or the **RETURN TO MENU** line and press the **Set Button** **15**. If you have no other adjustments to make, press the **OSD Button** **22** to exit the menu system.

PROGRAMMING THE REMOTE

Programming the Remote

The AVR 225 is equipped with a powerful remote control that will control not only the receiver's functions, but also most popular brands of audio and video equipment, including CD players, cassette decks, TV sets, cable boxes, VCRs, satellite receivers and other home theater equipment. Once the AVR 225's remote is programmed with the codes for the products you own, it is possible to eliminate most other remotes and replace them with the convenience of a single, universal remote control.

As shipped from the factory, the remote is fully programmed for all AVR 225 functions, as well as those of most Harman Kardon CD changers, DVD players, CD players and cassette decks. In addition, by following one of the methods below, you may program the remote to operate a wide range of devices from other manufacturers.

Direct Code Entry

This method is the easiest way to program your remote to work with different products.

1. Use the tables in the following pages to determine the three-digit code or codes that match both the product type, printed on the remote above the **Input Selector 5** (e.g., VCR, TV), and the specific brand name. If there is more than one number for a brand, make note of the different choices.
2. Turn on the unit you wish to program into the AVR 225 remote.
3. Press and hold both the **Input Selector 5** for the product you wish to control (e.g., VCR, TV) and the **Mute Button 38** at the same time. When the **Program/SPL Indicator 3** turns amber and begins flashing, and the **Input Selector 5** turns red, release the buttons. It is important that you begin the next step within 20 seconds.
4. Point the AVR 225's remote towards the unit to be programmed and enter the first three-digit code number using the **Numeric Keys 18**. The **Program/SPL Indicator 3** will change to a flashing green to indicate that a code has been entered. If the unit turns off, the correct code has been entered. Press the **Input Selector 5** again, and the red light will flash three times before going dark to confirm the entry.
5. If the device to be programmed in does NOT turn off, continue to enter three-digit code numbers until the equipment turns off. At this point, the correct code has been entered. Press the **Input Selector 5** again and the red light under the

Input Selector 5 will flash three times before going dark to confirm the entry.

6. Try all of the functions on the remote to make certain that the product operates properly. Keep in mind that many manufacturers use a number of different combinations of codes, so it is a good idea to make certain that not only the power control, but the volume, channel and transport controls work as they should. If functions do not work properly, you may need to use a different remote code.
7. If a code cannot be entered to turn the unit off, if the code for your product does not appear in the tables in this manual, or if not all functions operate properly, try programming the remote with the Auto Search Method.

Auto Search Method

If the unit you wish to include in the AVR 225's remote is not listed in the code tables in this manual or if the code does not seem to operate properly, you may wish to program the correct code using the Auto Search method that follows:

1. Turn on the unit that you wish to include in the AVR 225 remote.
2. Press the **Input Selector 5** for the type of product to be entered (e.g., VCR, TV) and the **Mute Button 38** at the same time. Hold both buttons until the red light under the **Input Selector 5** stays lit and the **Program/SPL Indicator 3** turns amber and begins flashing. Note that the next step must take place while the red light is on, and it must begin within 20 seconds after the light appears.
3. Point the AVR 225 remote toward the unit to be programmed and press either the **▲** or **▼** **Button 13 17**. The **Program/SPL Indicator 3** will change to a flashing green to indicate that a code has been entered. Each press will send out a three-digit code from the remote's built-in database. When the unit being programmed turns off, release the **▲** or **▼** **Button 13 17**, as that is your indication that the correct code is in use.
4. Press the **Input Selector 5**, and the red light under the Input Selector will flash three times before going dark to confirm the entry.
5. Try all of the functions on the remote to make certain that the product operates. Keep in mind that many manufacturers use a number of different combinations of codes, and it is a good idea to make certain that not only the power control works, but also that the volume, channel and

transport controls function properly. If all functions do not work properly, you may need to Auto-Search for a different code, or enter a code via the Direct Code Entry method.

Code Readout

When the code has been entered using the Auto Search method, it is always a good idea to find out the exact code so that it may be easily reentered if necessary. You may also read the codes to verify which device has been programmed to a specific Input Selector button.

1. Press and hold both the **Input Selector 5** for the device for which you wish to find the code and the **Mute Button 38** at the same time. The **Program/SPL Indicator 3** will initially turn amber. Release the buttons and begin the next step within 20 seconds.
2. Press the **Set Button 15**. The **Program/SPL Indicator 3** will blink green in a sequence that corresponds to the three-digit code, with a one-second pause between digits. Count the number of blinks between pauses to determine the digit of the code. One blink is the number 1, two blinks is the number 2, and so forth, while 10 blinks are used to indicate a "0."

Example: One blink, followed by a one-second pause, followed by six blinks, followed by a one-second pause, followed by 10 blinks indicates that the code has been set to 160.

For future reference, enter the Setup Codes for the equipment in your system here:

DVD _____ CD _____
VID1/VCR _____ VID2/TV _____
VID3/CBL/SAT _____
VID4 _____ TAPE _____

Macro Programming

Macros enable you to easily repeat frequently used combinations of commands with the press of a single button on the AVR 225 remote control. Once programmed, a macro will send out up to 19 different remote codes in a predetermined sequential order, enabling you to automate the process of turning on your system, changing devices or other common tasks. The AVR 225 remote can store up to five separate macro command sequences: one that is associated with the **Power On Button 4**, and four more that are accessed by pressing the **Macro Buttons 23**.

1. Press the **Mute Button 38** and the **Macro Button 23** to be programmed or the **Power On Button 4** at the same time. The last **Input Selector 5** pressed will light red, and the **Program/SPL Indicator 3** will flash amber.
2. Enter the steps for the macro sequence by pressing the button for the actual command step. Although the macro may contain up to 19 steps, each button press, including those used to change devices, counts as a step. The **Program/SPL Indicator 3** will flash green to confirm each button press as you enter commands.
3. When all the steps have been entered, press the **Sleep Button 9** to enter the commands. The **Program/SPL Indicator 3** will flash green three times and then turn off.

NOTE: While entering commands for Power On/Off of any device during a macro sequence, press the **Mute Button 38**. DO NOT press the actual Power button.

EXAMPLE: To program the **Macro 1 Button 23** so that it turns on the AVR 225, TV and a cable box, follow these steps:

- Press the **Macro 1 23** and **Mute 38** buttons at the same time and then release them.
- The **Program/SPL Indicator 3** will flash amber.
- Press the **AVR Selector 6**.
- Press the **Mute Button 38** to store the AVR 225's Power On command.
- Press the **VID2 Input Selector Button 5** to indicate the next command is to be transmitted to the TV.
- Press the **Mute Button 38** to store the TV Power On command.
- Press the **VID3 Input Selector Button 5** to indicate the next command is to be transmitted to the cable box.
- Press the **Mute Button 38** to store the cable Power On command.
- Press the **Sleep Button 9** to complete the process and store the macro sequence.

After following these steps, each time you press the **Macro 1 Button 23**, the remote will send the Power On/Off command to the AVR 225, the television and the cable box with a single button press.

Erasing Macro Commands

To erase the commands that have been programmed into one of the Macro buttons, follow these steps:

1. Press the **Mute Button 38** and the **Macro Button 23** that contains the commands you wish to erase.
2. The **Program/SPL Indicator 3** will flash amber, and the LED under the **AVR Selector 6** will turn red.
3. Within 10 seconds, press the **Surround Mode Selector/Channel Down Button 10**.
4. The red LED under the **AVR Selector 6** will go out, and the **Program/SPL Indicator 3** will turn green and flash three times before it goes out.
5. When the **Program/SPL Indicator 3** goes out, the Macro has been erased.

Programmed Device Functions

Once the AVR 225's remote has been programmed for the codes of other devices, press the appropriate **Input Selector 5** to change the remote from controlling the AVR 225 to controlling the additional product. When you press any one of the selectors, it will briefly flash in red to indicate that you've changed the device being controlled.

When operating a device other than the AVR 225, the controls may not correspond exactly to the function printed on the remote or button. Some commands, such as the Volume Control, are the same as they are with the AVR 225. Other buttons will change their function so that they correspond to a secondary label on the remote. For example, the Sleep and Surround mode selector buttons also function as the Channel Up and Channel Down buttons when operating most TV sets, VCRs or cable boxes. The Channel Up/Down indication is printed directly on the remote. For many standard CD players, cassette decks, VCRs and DVD functions, the standard function icons are printed on top of the buttons.

For some products, however, the function of a particular button does not follow the command printed on the remote. In order to see which function a button controls, consult the Function List tables on pages 36 and 37. To use those tables, first check the type of device being controlled (e.g., TV, VCR). Next, look at the remote control diagram pictured just before the

Function List tables. Note that each button has a number on it.

To find out what function a particular button has for a specific device, find the button number on the Function List and then look in the column for the device you are controlling. For example, button number 53 is the Macro 2 button for the AVR 225, but it is the "Favorite" button for many cable television boxes and satellite receivers. Button number 31 is the Delay button for the AVR 225, but the Time Display button for CD players.

NOTE: The numbers used to describe the button functions in the diagram on page 35 for the purposes of describing how a button operates are a different set of numbers than those used in the rest of this manual to describe the button functions for the AVR 225.

Notes on Using the AVR 225 Remote With Other Devices

- Manufacturers may use different code sets within the same product category, such as TV sets or VCRs. They may also change codes for a certain category from one model year to the next. For that reason, it is important that you check to see whether the code set you have entered operates as many controls as possible. If it appears that only a few functions operate, check to see whether another code set will work with more buttons.
- When a button is pressed on the AVR 225 remote, the red light under the **Input Selector 5** for the product being operated should flash briefly. If the Device Control Selector flashes for some but not all buttons for a particular product, it does NOT indicate a problem with the remote but rather that no function is programmed for the button being pushed.

Punch-Through Programming

The AVR 225's remote may be programmed to control one device, such as a TV, while simultaneously directing only certain functions to another device, such as the transport controls of a DVD player, without having to switch back and forth between inputs. You may also use the remote to control the system volume on the AVR without the need to switch between different devices. This is called "Punch-Through," and this section will show you how to program the remote for these functions.

NOTE: All programming for the remote codes needed to operate specific devices, such as a TV, DVD, cable box, satellite receiver or VCR, should be completed before programming punch-through commands.

PROGRAMMING THE REMOTE

Volume Punch-Through

The AVR 225's remote may be programmed to operate the **Volume Control** 34 and **Mute** 38 functions of either the TV or the AVR 225 in conjunction with any of the devices controlled by the remote. For example, since the AVR 225 will likely be used as the sound system for TV viewing, you may wish to have the AVR 225's volume activated, although the remote is set to run the TV. Either the AVR 225 or TV volume control may be associated with any of the remote's devices. To program the remote for Volume Punch-Through, follow these steps:

1. Press the **Input Selector** 5 for the unit you will be using (e.g., TV) when you wish to have Volume Punch-Through to your audio system active and the **Mute Button** 38 at the same time until the red light appears under the **Input Selector** 5 and the **Program/SPL Indicator** 3 flashes amber.
2. Press the **Volume Up Button** 34 and note that the **Program/SPL Indicator** 3 will stop flashing and stay amber.
3. Press either the **AVR Selector** 6 or the **Input Selector** 5, depending on which system's volume control you wish to have attached for the punch-through mode. The **Program/SPL Indicator** 3 will blink green three times and then go out to confirm the data entry.

Example: To have the AVR 225's volume control activated even though the remote is set to control the TV, first press the **VID2/TV Input Selector** 5 and the **Mute Button** 38 at the same time. Next, press the **Volume Up Button** 34, followed by the **AVR Selector** 6.

NOTE: Should you wish to return the remote to the original configuration after entering a Volume Punch-Through, you will need to repeat the steps shown above. However, press the same Input Selector in Steps 1 and 3.

Channel Control Punch-Through

The AVR 225's remote may be programmed to operate so that the channel control function for either the TV, cable or satellite receiver used in your system may be used in conjunction with one of the other devices controlled by the remote. For example, while using and controlling the VCR, you may wish to change channels on a cable box or satellite receiver without having to change the device selected by the AVR 225 or the remote. To program the remote for Channel Control Punch-Through, follow these steps:

1. Press the **Input Selector Button** 5 for the device you will be using (e.g., VCR) when you wish to have

Channel Punch-Through active and the **Mute Button** 38 at the same time until the red light appears under the **Input Selector** 5 and the **Program/SPL Indicator** 3 flashes amber.

2. Press the **Volume Down Button** 34. The **Program/SPL Indicator** 3 will stop flashing and stay amber.
3. Press and release the **Input Selector Button** 5 for the device that will be used to change the channels. The **Program/SPL Indicator** 3 will blink green three times and then go out to confirm the data entry.

Example: To control the channels using your cable box or satellite receiver while the remote is set to control the VCR, first press the **VID1/VCR Input Selector Button** 5 and the **Mute Button** 38 at the same time. Next, release them and press the **Volume Down Button** 34, followed by the **VID2/TV Input Selector Button** 5.

NOTE: To remove the Channel Control Punch-Through and return the remote to its original configuration, repeat the steps shown above. However, press the same button in Steps 1 and 3.

Transport Control Punch-Through

The AVR 225's remote may be programmed to operate so that the **Transport Control Functions** 24 (Play, Stop, Fast Forward, Rewind, Pause and Record) for a VCR, cassette deck, DVD or CD will operate in conjunction with one of the other devices controlled by the remote. For example, while using and controlling the TV, you may wish to start or stop your VCR or DVD without having to change the device selected by the AVR 225 or the remote. To program the remote for Transport Control Punch-Through, follow these steps:

1. Press the **Input Selector** 5 for the device you will be using (e.g., TV) when you wish to have Transport Control Punch-Through active and the **Mute Button** 38 at the same time until the red light appears under the **Input Selector** 5 and the **Program/SPL Indicator** 3 flashes amber.
2. Press the **Play Button** 24. The **Program/SPL Indicator** 3 will stop flashing and stay amber.
3. Press and release the **Input Selector Button** 5 for the device whose transport mechanism will be controlled (e.g., DVD, CD). The **Program/SPL Indicator** 3 will blink green three times and then go out to confirm the data entry.

Example: To control the transport of a DVD player while the remote is set to control the TV, first press

the **VID2/TV Input Selector Button** 5 and the **Mute Button** 38 at the same time. Next, release them and press the **Play Button** 24, followed by the **DVD Input Selector Button** 5.

NOTE: To remove the Channel Control Punch-Through and return the remote to its original configuration, repeat the steps shown above. However, press the same button in Steps 1 and 3.

Resetting the Remote Memory

As you add components to your home theater system, occasionally you may wish to totally reprogram the remote control without the confusion of any commands, macros or "Punch-Through" programming that you may have done. To do this, it is possible to reset the remote to the original factory defaults and command codes by following these steps. Note, however, that once the remote is reset, all commands or codes that you have entered will be erased and will need to be reentered:

1. Press any of the **Input Selector Buttons** 5 and the **"0" Button** 18 at the same time until the **Program/SPL Indicator** 3 begins to flash amber.
2. Press the **"3" Button** 18 three times.
3. The red LED under the **Input Selector** 5 will go out and the **Program/SPL Indicator** 3 will stop flashing and turn green.
4. The **Program/SPL Indicator** 3 will remain green until the remote is reset. Note that this may take a while, depending on how many commands are in the memory and need to be erased.
5. When the **Program/SPL Indicator** 3 goes out, the remote has been reset to the factory settings.

PROGRAMMING THE REMOTE

This diagram shows the button numbers used in the Function List tables on pages 36 and 37. Do not confuse these numbers with those used throughout the rest of this manual to indicate the specific buttons used to operate the AVR 225's functions. The key to use those button numbers (which are shown inside an oval) is found on pages 11–13.

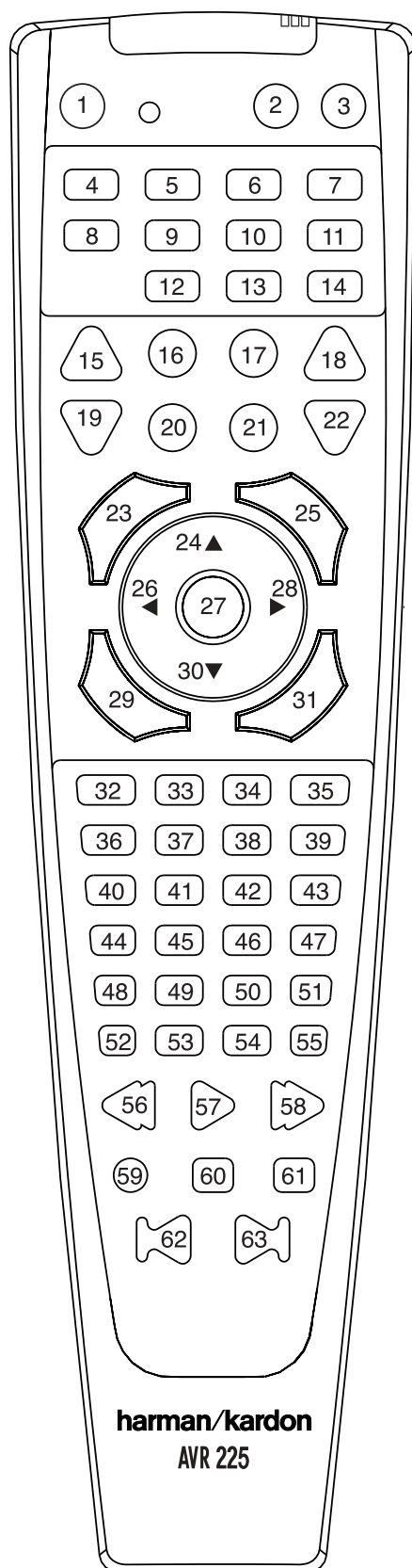

FUNCTION LIST

No.	Button Name	AVR Function	DVD	CD/CDR	Tape	VCR (VID1)	TV (VID1)	CBL (VID3)	SAT (VID3)
1	Power On	Power On	Power On	Power On	Power On	Power On	Power On	Power On	Power On
2	Power Off	Power Off	Power Off	Power Off	Power Off	Power Off	Power Off	Power Off	Power Off
3	Mute	Mute	Mute	Mute	Mute	Mute	Mute	Mute	Mute
4	AVR	AVR Select							
5	DVD	DVD Input Select	DVD Select						
6	CD	CD Input Select		CD Select					
7	Tape	Tape Input Select			Tape Select				
8	VID1/VCR	Video 1 Select				VCR Select	TV Select	VID3 Select	
9	VID2/TV	Video 2 Select							
10	VID3/CBL/Sat	Video 3 Select							
11	VID4	Video 4 Select							
12	AM/FM	Tuner Select							
13	6 Ch. Select	6 Ch Input Select							
14	SPL				Left	Left	Left	Left	Left
15	Sleep/Channel Up	Sleep					Channel +	Channel +	Channel +
16	Test	Test Tone		Input Select					
17	TV/Video		TV/DVD	CDP Select		TV/VCR	TV/VCR	TV/Cable	TV/Sat
18	Volume Up	Volume Up		Input Level Up		Volume Up	Volume Up	Volume Up	Volume Up
19	Surround Select/Channel Down	Surround Mode Select		CDR Select		Channel –		Channel –	Channel –
20	Night	Night Mode Select							
21	Spare								
22	Volume Down	Volume Down		Input Level Down			Volume Down	Volume Down	Volume Down
23	Channel/Guide	Channel Trim	Title					Info/Guide	Info/Guide
24	▲	Move/Adjust Up	Up			Up	Up	Up	Up
25	Speaker/Menu	Speaker Adjust	Menu			Menu	Menu	Menu	Menu
26	◀	Move/Adjust Left	Left			Left	Left	Left	Left
27	Set	Set	Enter			Enter	Enter	Enter	Enter
28	▶		Right			Right	Right	Right	Right
29	Digital/Exit	Digital Input Select	Subtitle			Exit	Exit	Exit	Exit
30	▼	Move/Adjust Down	Down			Down	Down	Down	Down
31	Delay/Prev. Ch.	Delay Adjust	Return	Time			Prev Channel	Prev Channel	Prev Channel
32	1		1	1		1	1	1	1
33	2		2	2		2	2	2	2
34	3		3	3		3	3	3	3
35	4		4	4		4	4	4	4
36	5		5	5		5	5	5	5
37	6		6	6		6	6	6	6
38	7		7	7		7	7	7	7
39	8		8	8		8	8	8	8
40	Tun-M	Tuning Mode							
41	9		9	9		9	9	9	9
42	0		0	0		0	0	0	0
43	Memory								
44	Tune Up	Tune Up	Next Chapter						

FUNCTION LIST

No.	Button Name	AVR Function	DVD	CD/CD-R	Tape	VCR (VID1)	TV (VID1)	CBL (VID3)	SAT (VID3)
45	Direct	Direct Tuner Entry		Track Direct					
46	Clear	Clear	Clear	Clear		Clear	Clear	Clear	Clear
47	Preset Up	Preset Tune Up	Slow Forward						
48	Tune Down	Tune Down	Prev Chapter	Track Increment					
49	OSD	OSD				OSD	OSD	OSD	OSD
50	D. Skip		Disc Skip	Disc Skip	Stop	Stop			
51	Preset Down	Preset Tune Down	Slow Rev	Intro Scan					
52	M1		Open/Close	Open/Close		Cancel	Sleep	PPV	Cancel
53	M2		Subtitle On/Off	Repeat				Fav	Fav
54	M3		Audio Select	Random Play				Bypass	Next
55	M4		Angle Select					Music	Alt
56	Rewind		R. Search	R. Search	Rewind	Rewind		Day -	Day -
57	Play/Reverse Play		Play	Play	Play	Play			
58	Fast Forward		F. Search	F. Search	Fast Fwd	Fast Fwd		Day +	Day +
59	Record			Record	Record	Record			
60	Stop		Stop	Stop	Stop	Stop			
61	Pause		Pause	Pause	Pause	Pause			
62	Skip Down		Skip -	Skip -		Scan -		Page -	Page -
63	Skip Up		Skip +	Skip +		Scan +		Page +	Page +

SETUP CODE TABLE: TV

Manufacturer/Brand	Setup Code Number
A MARK	103 132
ADMIRAL	192
AKAI	123 160
AMPRO	164
ANAM	045 103 106 109 112 122
AOC	103 123 128
BLAUPUNKT	084
BROKSONIC	205 206
CANDLE	123 128
CAPEHART	059
CENTURION	123 171
CENTRONIC	045
CITIZEN	045 123 128 132
CLASSIC	045
CONCERTO	128
CONTEC	045
CORANDO	172
CORONADO	132
CRAIG	045 157 158 159
CROWN	045 132
CURTIS MATHES	123 128 132
CXC	045
DAEWOO	045 087 102 105 106 108 111 114 116 119 127 128 132
DAYTRON	128 132
DIGI LINK	200
DYNASTY	045
DYNATECH	063
ELECTROHOME	115 132
EMERSON	045 123 128 132 139 157 158 159 162 205
FUNAI	045
FUTURETECH	045
GE	087 121 123 128 133 145 159 163
GOLDSTAR	101 103 110 128 132
GRUNDIG	193
HALL MARK	128
HARMAN KARDON	201
HITACHI	123 128 132 144 147
INFINITY	148
INKEL	120
JBL	148
JC PENNEY	115 123 128 132 145
JENSEN	019
JVC	079 087 134
KAWASHO	173
KEC	045
KENWOOD	123 204
KMC	132
KTV	045 123 132 162
LLOYTRON	172 173
LODGENET	069
LOGIK	069
LUXMAN	128
LXI	077 145 148

SETUP CODE TABLE: TV

Manufacturer/Brand	Setup Code Number
MAGNAVOX	123 128 132 145 148
MARANTZ	115 123 148
MATSUI	148
MEMOREX	069 128
METZ	084
MGA	115 123 128
MINERVA	084
mitsubishi	077 115 123 128 160 167 168
MTC	175 176
NATIONAL	148 177 179 180 181 182
NEC	115 121 123 125
NIKEI	045
ONKING	045
ONWA	045
OPTONICA	077
ORION	207 208 209 225 211
PANASONIC	087 148 169
PHILCO	045 115 123 128 132 148
PHILIPS	123 128 132 145 148
PIONEER	024 123 128 213 214
PORTLAND	128 132
PROSCAN	133
PROTON	059 122 128 132 165
QUASAR	087
RADIO SHACK	045 128 132 180 196 197
RCA	115 123 128 133 145 161 163
REALISTIC	045 196 197
RUNCO	152 153
SAA	183
SAMPO	059 123 128
SAMSUNG	124 128 132 145
SANYO	054
SCOTT	045 128 132
SEARS	128 132 145
SHARP	077 128 132
SIEMENS	084
SIGNATURE	069
SONY	117 130 136 194 212
SOUNDESIGN	045 128
SPECTRICON	103
SSS	045
SYLVANIA	123 128 145 148
SYMPHONIC	184
TANDY	077
TATUNG	063
TECHNICS	080
TECHWOOD	128
TEKNIKA	045 069 115 123 128 132
TELERENT	069
TERA	156
THOMSON	190 191
TMK	128
TOSHIBA	063 129 202

SETUP CODE TABLE: TV

Manufacturer/Brand	Setup Code Number
TOTEVISION	132
VIDEO CONCEPTS	160
VIDTECH	128
WARDS	069 128 132 148
YAMAHA	123 128
YORK	128
YUPITERU	045
ZENITH	069 090
ZONDA	103

SETUP CODE TABLE: VCR

Manufacturer/Brand	Setup Code Number
AIWA	040
AKAI	048 108 109 126
AMPRO	076
ASA	134
AUDIO DYNAMICS	018 048
BROKSONIC	110 147
CANDLE	134 135
CANON	135 140
CAPEHART	094
CITIZEN	134
CRAIG	045 116
DAEWOO	017 094 104
DAYTRON	094
DBX	018 048
DYNATECH	040
EMERSON	013 040 042 110 112
FISHER	017
FUNAI	040
GE	076 095 124
GO VIDEO	113
GOLDSTAR	018 107
HARMAN KARDON	018 049
HITACHI	040 048
JC PENNEY	018 045
JENSEN	048
JVC	018 048 111 132
KENWOOD	020 048
LLOYD	040
LXI	020 040
MAGIN	045
MAGNAVOX	040
MARANTZ	018
MEMOREX	017 020 040 076
MGA	049
mitsubishi	049 131
MULTITECH	040
NAD	139

SETUP CODE TABLE: VCR

Manufacturer/Brand	Setup Code Number
NATIONAL	140
NEC	018 048
NORDMENDE	048
OPTIMUS	159
ORION	147
PANASONIC	125 150 167 172
PHILCO	040
PHILIPS	040 075
PORTLAND	094
PULSAR	076
QUASAR	001 125
RADIO SHACK	134 140 142 158 159
RCA	095 124 125 157 172
REALISTIC	017 020 040 045 159
SALORA	020
SAMSUNG	045 095 105 109
SANSUI	048 116 147
SANYO	017 020
SCOTT	110 112
SEARS	017 020
SHARP	129 156
SONY	080 129
SOUNDESIGN	040
SYLVANIA	040
SYMPHONIC	040
TANDY	017 040
TASHICO	134
TATUNG	048
TEAC	040 048
TEKNIKA	040
THOMAS	040
TMK	013
TOSHIBA	112 155
TOTEVISION	045
UNITECH	045
VECTOR RESEARCH	018
VIDEO CONCEPTS	018 040
VIDEOSONIC	045
WARDS	040 045 112
YAMAHA	018 040 048
ZENITH	040 076 083

SETUP CODE TABLE: CD

Manufacturer/Brand	Setup Code Number
ADCOM	063 069
AIWA	072 111 118 156 170
AKAI	050 177 184
AUDIO TECHNICA	053
AUDIOACCESS	125
AUDIOFILE	211
BSR	044
CALIFORNIA AUDIO	015 109
CAPETRONIC	070
CARRERA	087
CARVER	136 140 141 143 144 145 185 186
CASIO	117 122 166
CLARINETTE	122 166
DENON	187 188 213
EMERSON	052 093 108
FISHER	055 068
FRABA	117
FUNAI	126
GE	164
GENEXXA	108
GOLDSTAR	016 087
HAITAI	099 214
HARMAN KARDON	001 002 025 054 190 218 219
HITACHI	093
INKEL	216
JC PENNEY	098 147
JENSEN	153
JVC	176 195 196
KENWOOD	030 062 078 079 148 151 176 178 181
LOTTE	108
LUXMAN	077 102
LXI	164
MAGNAVOX	039 113
MARANTZ	058 084 191 192 193
MCINTOSH	194
MCS	080 098
MITSUMI	152
MODULAIRE	122 166
NAD	013 074 197 198
NAKAMICHI	199 200 201
NEC	069
NIKKO	053 055
ONKYO	037 038 045 046 171 175 202 203
OPTIMUS	065 089 091 092 099 104 212
PANASONIC	015 075 109 119 158 183 204
PHILIPS	039 138 149 209
PIONEER	071 094 100 112 123 131 161 162 215
PROTON	225
QUASAR	015 109
RADIO SHACK	122 126 213
RCA	024 081 093 150

SETUP CODE TABLE: CD

Manufacturer/Brand	Setup Code Number
RCX	169
REALISTIC	058 093 095 104 105 108 164 166
SANSUI	047 081 134 157 172
SANYO	033 068 082 095 168
SCOTT	108
SHARP	058 105 114 151 159 167 180 181
SHERWOOD	003 041 058 105 133
SONY	103 115 116 118 132 139 163 205 206 207 208 212 217
SOUNDSTREAM	124
SYMPHONIC	059 110
TAEKWANG	177
TEAC	011 058 085 086 106 107 110 121 137 146 154
THETA DIGITAL	039
TOSHIBA	013 074 097 151 155 173
VECTOR RESEARCH	087
VICTOR	120 130
WARDS	095
YAMAHA	019 031 053 061 135 169
YORK	122 166

SETUP CODE TABLE: TAPE

Manufacturer/Brand	Setup Code Number
HARMAN KARDON	001

SETUP CODE TABLE: AUDIO

Manufacturer/Brand	Setup Code Number
HARMAN KARDON	001

SETUP CODE TABLE: DVD

Manufacturer/Brand	Setup Code Number
APEX DIGITAL	061
DENON	019 051
GE	003 004
GOLDSTAR	005
HARMAN KARDON	001
JVC	006
LG	005 055 064
MAGNAVOX	056
MARANTZ	059
MITSUBISHI	023
NAD	062
ONKYO	009 048
PANASONIC	024 030 044
PHILIPS	056
PIONEER	041 065
PROCEED	060
PROSCAN	003 004
RCA	003 004
SAMSUNG	053 054
SHARP	028
SONY	043 045
THOMSON	003 004
TOSHIBA	009 058
YAMAHA	030 063
ZENITH	005 055 064

SETUP CODE TABLE: SAT

Manufacturer/Brand	Setup Code Number
ALPHASTAR	472
ALPHASTAR DBS	450
ALPHASTAR DSR	442
BIRDVIEW	425
CHANNEL MASTER	320 321 322 325 361
CHAPARRAL	315 316 380 451
CITOH	360
DRAKE	313 317 318 413 481
DX ANTENNA	331 352 362 379 483
ECHOSTAR	395 397 452 453 463 477 478 484 485
ELECTRO HOME	392
FUJITSU	324 329 334
GENERAL INSTRUMENT	303 311 323 365 403 454 468 474
HITACHI DBS	455
HOUSTON TRACKER	463
HUGHES	437
JANIEL	366
JERROLD	454 468 484
KATHREIN	410
LEGEND	453
MACOM	317 365 369 370 371
MAGNAVOX	461 473
MEMOREX	453
NEXTWAVE	423
NORSAT	373
OPTIMUS	466
PANASONIC	366 469
PANASONIC DBS	457
PANSAT	420
PERSONAL CABLE	418
PHILIPS	375
PICO	407
PRESIDENT	381 404
PRIMESTAR	412 454 468 475
RCA	301 439 458 465
REALISTIC	349 480
SAMSUNG	442
SATELLITE SERVICE CO	335 388
SCIENTIFIC ATLANTA	339
SONY	405
STAR CHOICE DBS	459
STARCAST	347
SUPER GUIDE	327 423
TEECOM	330 333 390 391 393 409
TOSHIBA	302 426 460 461 462 470
UNIDEN	323 332 348 349 350 351 354 355 381 383 389 403 466 479 480
ZENITH	384 385 387 394 419

SETUP CODE TABLE: CBL

Manufacturer/Brand	Setup Code Number
ABC	001 011
ALLEGRO	111
AMERICAST	212
ARCHER	112
BELCOR	113
CABLE STAR	033 113
CITIZEN	111
COLOUR VOICE	085 090
DIGI	114
EAGLE	186
EASTERN	066 070
ELECTRICORD	039
EMERSON	112
FOCUS	116
G.I.	001 011 017 096 097
GC ELECTRONICS	113
GEMINI	032 060
GENERAL	225
GENERAL INSTRUMENT	168
GOODMIND	112
HAMLIN	056 099 100 101 117 175 208
HITACHI	001 188
JASCO	111
JERROLD	001 002 011 017 073 096 097 162 168 188 210
LINDSAY	118
MACOM	191
MAGNAVOX	017 019 068
MOVIE TIME	035 039
NSC	035 190
OAK	197
PACE	179
PANASONIC	053 176 177 189 214
PANTHER	114
PHILIPS	013 019 020 085 090
PIONEER	001 041 119 171 209
POPULAR MECHANICS	116
PRELUDE	120
PRIMESTAR	162
RADIO SHACK	111 112 213
RCA	053 214
RECOTON	116
REGAL	056 099 100 101 208

SETUP CODE TABLE: CBL

Manufacturer/Brand	Setup Code Number
REMBRANT	032
SAMSUNG	072 186
SCIENTIFIC ATLANTA	183 203
SEAM	121
SIGNATURE	001 188
SPRUCER	053 081 177 189
STARCOM	002 011 163
STARGATE	120
TANDY	024
TELECAPATION	028
TEXSCAN	036
TFC	122
TIMELESS	123
TOCOM	170 205
UNITED CABLE	011
UNIVERSAL	033 034 039 042 113
VIDEOWAY	124 211
VIEWSTAR	019 025 086 089 190
ZENITH	065 125 211
ZENITEK	116

TROUBLESHOOTING GUIDE

Your AVR 225 receiver has been designed to provide many years of trouble-free service. In the event that you are experiencing difficulties, please check the suggestions below for a possible solution to your problem. Additional information on the AVR 225, including updated information and user hints, is available from our Web site at www.harmankardon.com.

SYMPTOM	CAUSE	SOLUTION
Unit does not function when Main Power Switch is pushed	<ul style="list-style-type: none">• No AC Power	<ul style="list-style-type: none">• Make certain AC power cord is plugged into a live outlet• Check to see whether outlet is switch-controlled
Display lights, but no sound or picture	<ul style="list-style-type: none">• Intermittent input connections• Mute is on• Volume control is down	<ul style="list-style-type: none">• Make certain that all input and speaker connections are secure• Press Mute button• Turn up volume control
Unit turns on, but front-panel display does not light up	<ul style="list-style-type: none">• Display brightness is turned off	<ul style="list-style-type: none">• Follow the instructions in the Display Brightness section on page 30 so that the display is set to VFD FULL
No sound from any speaker; light around power switch is red	<ul style="list-style-type: none">• Amplifier is in protection mode due to possible short• Amplifier is in protection mode due to internal problems	<ul style="list-style-type: none">• Check speaker wire connections for shorts at receiver and speaker ends• Contact your local Harman Kardon service center, which you can locate by visiting our Web site at www.harmankardon.com
No sound from surround or center speakers	<ul style="list-style-type: none">• Incorrect surround mode• Input is monaural• Incorrect configuration• Stereo or Mono program material	<ul style="list-style-type: none">• Select a mode other than Stereo or Dolby 3 Stereo• There is no surround information from mono sources• Check speaker mode configuration• The surround decoder may not create center- or rear-channel information from nonencoded programs
Unit does not respond to remote commands	<ul style="list-style-type: none">• Weak batteries in remote• Wrong device selected• Remote sensor is obscured	<ul style="list-style-type: none">• Change remote batteries• Press the AVR selector• Make certain front-panel sensor is visible to remote or connect remote sensor
Intermittent buzzing in tuner	<ul style="list-style-type: none">• Local interference	<ul style="list-style-type: none">• Move unit or antenna away from computers, fluorescent lights, motors or other electrical appliances
Letters flash in the channel indicator display and digital audio stops	<ul style="list-style-type: none">• Digital audio feed paused	<ul style="list-style-type: none">• Resume play for DVD• Check that Digital Input is selected

Processor Reset

In the rare case in which the unit's operation or displays seem abnormal, the cause may involve the erratic operation of the system's memory or microprocessor.

To correct this problem, first unplug the unit from the AC wall outlet and wait at least three minutes. After the pause, reconnect the AC power cord and check the unit's operation. If the system still malfunctions, a system "reset" may clear the problem.

To clear the AVR 225's entire system memory including tuner presets, output level settings, delay times and speaker configuration data, first put the unit in Standby

by pressing the **System Power Control Button** **2**. Next, press and hold the **Tone Mode Button** **6** for three seconds.

The unit will turn on automatically and display the **RESET** message in the **Main Information Display** **S**. Note that once you have cleared the memory in this manner, it is necessary to reestablish all system configuration settings and tuner presets.

The reset will not affect settings that were programmed into the remote control. To reset the remote control and restore it to its factory default settings, please follow the instructions on page 34.

If these steps do not solve the problem, consult an authorized Harman Kardon service center. You can locate the service center nearest to you by visiting our Web site at www.harmankardon.com.

Memory Backup

This product is equipped with a memory backup system that preserves the system configuration information and tuner presets if the unit is accidentally unplugged or subjected to a power outage. This memory will last for approximately one week, after which time all information must be reentered.

TECHNICAL SPECIFICATIONS

Audio Section

Stereo Mode

Continuous Average Power (FTC)

65 Watts per channel, @ < 0.07% THD, 20Hz – 20kHz,
both channels driven into 8 ohms

Five-Channel Surround Modes

Power Per Individual Channel

Front L&R channels:

55 Watts per channel

@ < 0.07% THD, 20Hz–20kHz into 8 ohms

Center channel:

55 Watts @ < 0.07% THD, 20Hz–20kHz into 8 ohms

Surround channels:

55 Watts per channel

@ < 0.07% THD, 20Hz–20kHz into 8 ohms

Input Sensitivity/Impedance

Linear (High-Level) 200mV/47k ohms

Signal-to-Noise Ratio (IHF-A) 95dB

Surround System Adjacent Channel Separation

Analog Source Decoding 45dB

Dolby Digital 55dB

DTS 55dB

Frequency Response

@ 1W (+0dB, –3dB) 10Hz–100kHz

High Instantaneous

Current Capability (HCC)

±28 Amps

Transient Intermodulation

Distortion (TIM)

Unmeasurable

Slew Rate

40V/μsec

FM Tuner Section

Frequency Range	87.5–108.0MHz
Usable Sensitivity	IHF 1.3 μV/13.2dB
Signal-to-Noise Ratio	Mono/Stereo 70dB/68dB
Distortion	Mono/Stereo 0.2%/0.3%
Stereo Separation	40dB @ 1kHz
Selectivity	±400kHz, 70dB
Image Rejection	80dB
IF Rejection	90dB

AM Tuner Section

Frequency Range	520–1720kHz
Signal-to-Noise Ratio	45 dB
Usable Sensitivity	Loop 500μV
Distortion	1kHz, 50% Mod 0.8%
Selectivity	±10kHz, 30dB

Video Section

Television Format	NTSC
Input Level/Impedance	1Vp-p/75 ohms
Output Level/Impedance	1Vp-p/75 ohms
Video Frequency Response	10Hz–8MHz (–3dB)

General

Power Requirement	AC 120V/60Hz
Power Consumption	68W idle, 540W maximum (2 channels driven)
Dimensions (Max)	
Width	17.3 inches (440mm)
Height	6.6 inches (168mm)
Depth	15.4 inches (390mm)
Weight	26.8 lb (12.2kg)

Depth measurement includes knobs, buttons and terminal connections.

Height measurement includes feet and chassis.

All features and specifications are subject to change without notice.

* See the following trademark acknowledgements:

Harman Kardon and Power for the Digital Revolution are registered trademarks of Harman Kardon, Inc.

|||||BzSet is a trademark of Harman International Industries, Inc. (patent no. 5,386,478).

Manufactured under license from Dolby Laboratories. "Dolby," "Pro Logic" and the Double-D symbol are registered trademarks of Dolby Laboratories. Confidential Unpublished Works. ©1992–1999 Dolby Laboratories, Inc. All rights reserved.

"DTS" and "DTS Digital Surround" are trademarks of Digital Theater Systems, Inc.

UltraStereo is a trademark of UltraStereo Corp.

VMAx is a registered trademark of Harman International Industries, Inc., and is an implementation of Cooper Bauck Transaural Stereo under patent license.

Logic 7 is a registered trademark of Lexicon, Inc., a Harman International Company, and Harman International Industries, Inc.

Crystal is a registered trademark of Cirrus Logic Corp.

harman/kardon®

H A Harman International Company
250 Crossways Park Drive, Woodbury, New York 11797
www.harmankardon.com
© 2002 Harman Kardon, Incorporated
Part No.: CQX1A779Z

Thank you for purchasing a Harman Kardon AVR 225. This Quick-Start Guide will help you with a basic system installation. For detailed information on any step in this Guide, please refer to the pages referenced in the Owner's Manual. We strongly recommend that you read the Owner's Manual for complete details on how to install, configure and operate the AVR 225, as well as for the important safety information it contains.

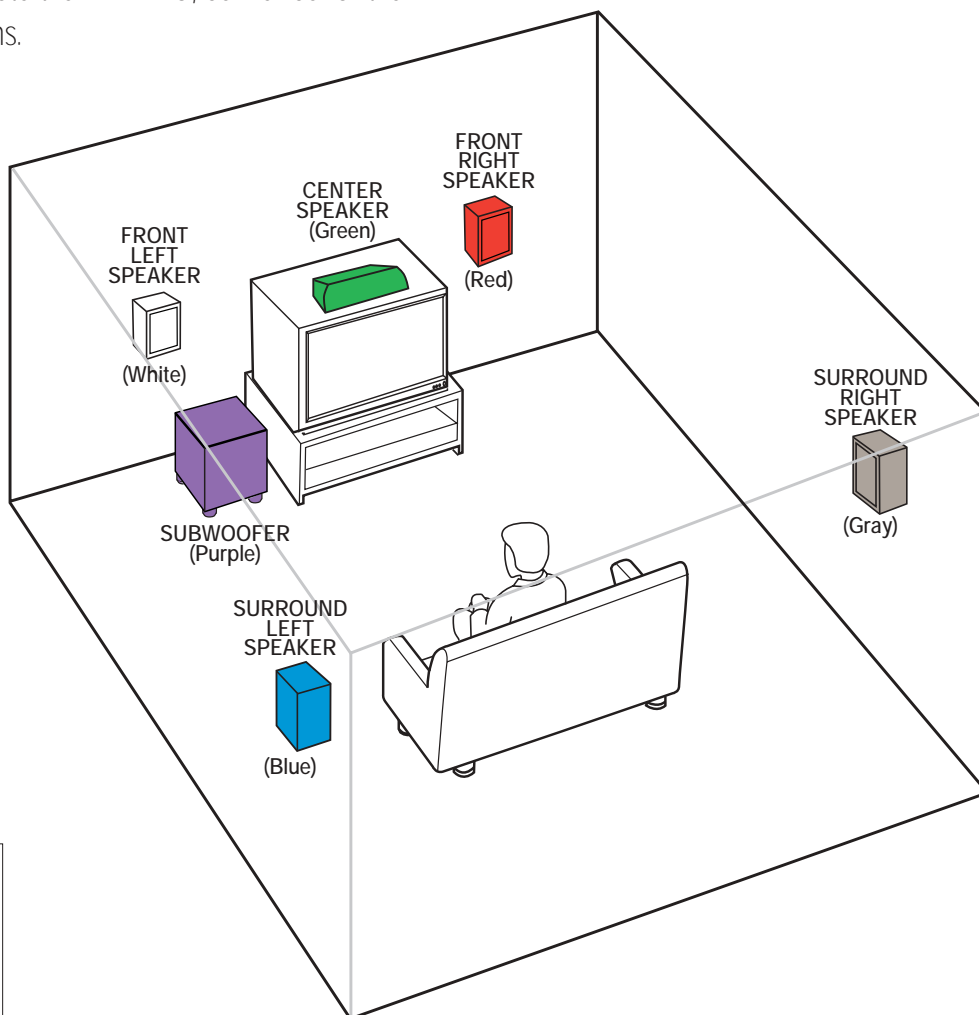

Figure 1 – Speaker Placement

The colors shown for each speaker correspond to the matching output terminal connection on the back of the AVR 225 (see page 14).

Connections Color Guide		
Audio Connections	Left	Right
Front	White	Red
Center	Green	
Surround	Blue	Gray
Subwoofer	Purple	
Digital Audio Connections		
Coax	Orange	
Optical	Optical icon	
Video Connections		
Composite	Yellow	
S-Video	S-Video icon	
Match the colored jacks on the AVR 225 to the appropriate jacks on your source equipment or speakers. The colors are standardized, but not all equipment or connectors use them.		

Step 1. Place your speakers in the listening room (see page 16).

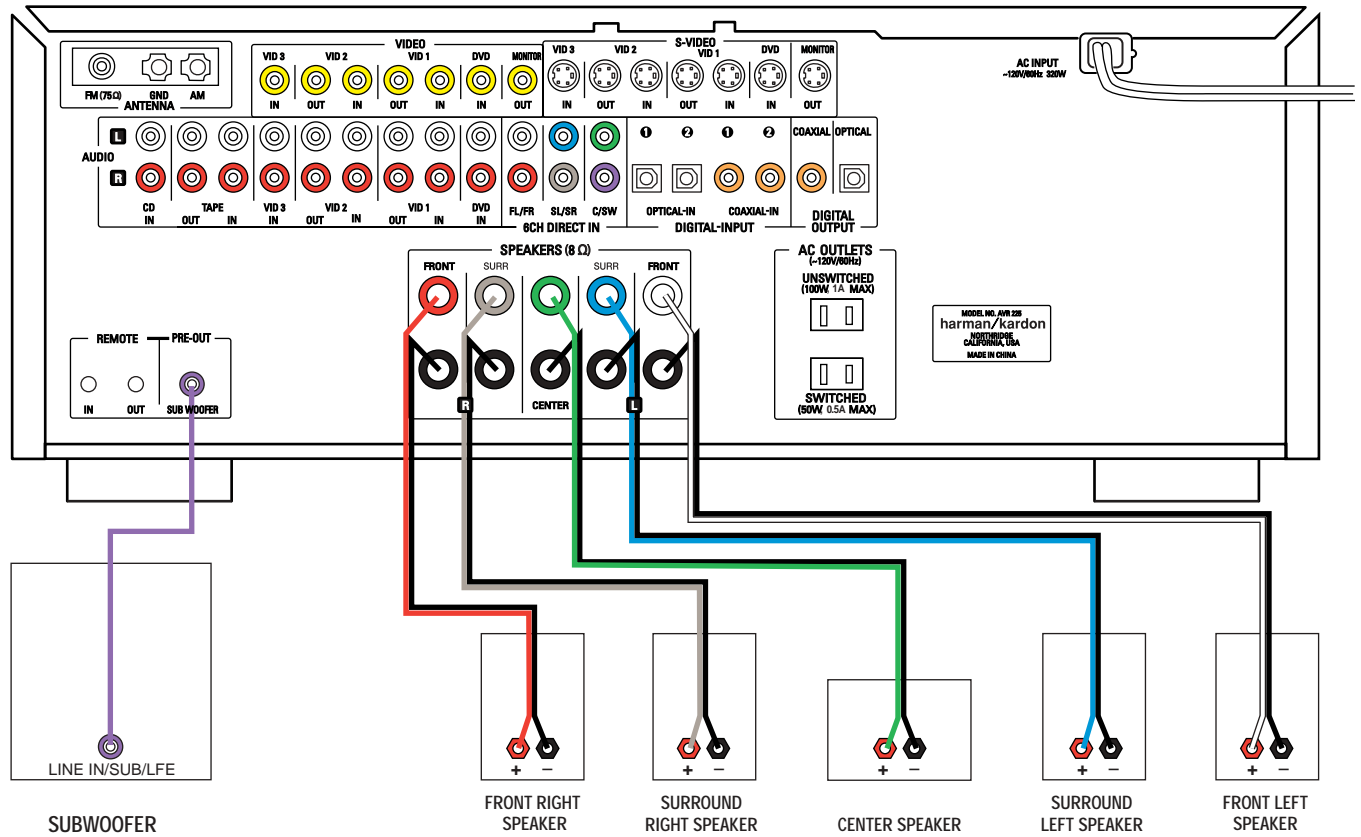

Figure 2 – Speaker Connections

Step 2. Connect the speakers to the receiver: Red (+) on speaker to colored (+) on receiver and black (-) to black (-). (See page 14.)

Step 3. Connect the Subwoofer Pre-Out jack to the Line-In jack on your subwoofer (see page 16). Adjust the settings on the subwoofer as needed.

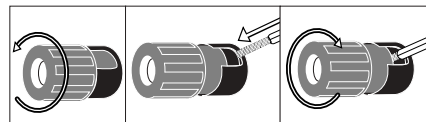

Figure 3 – How to Use the Binding-Post Speaker Terminal

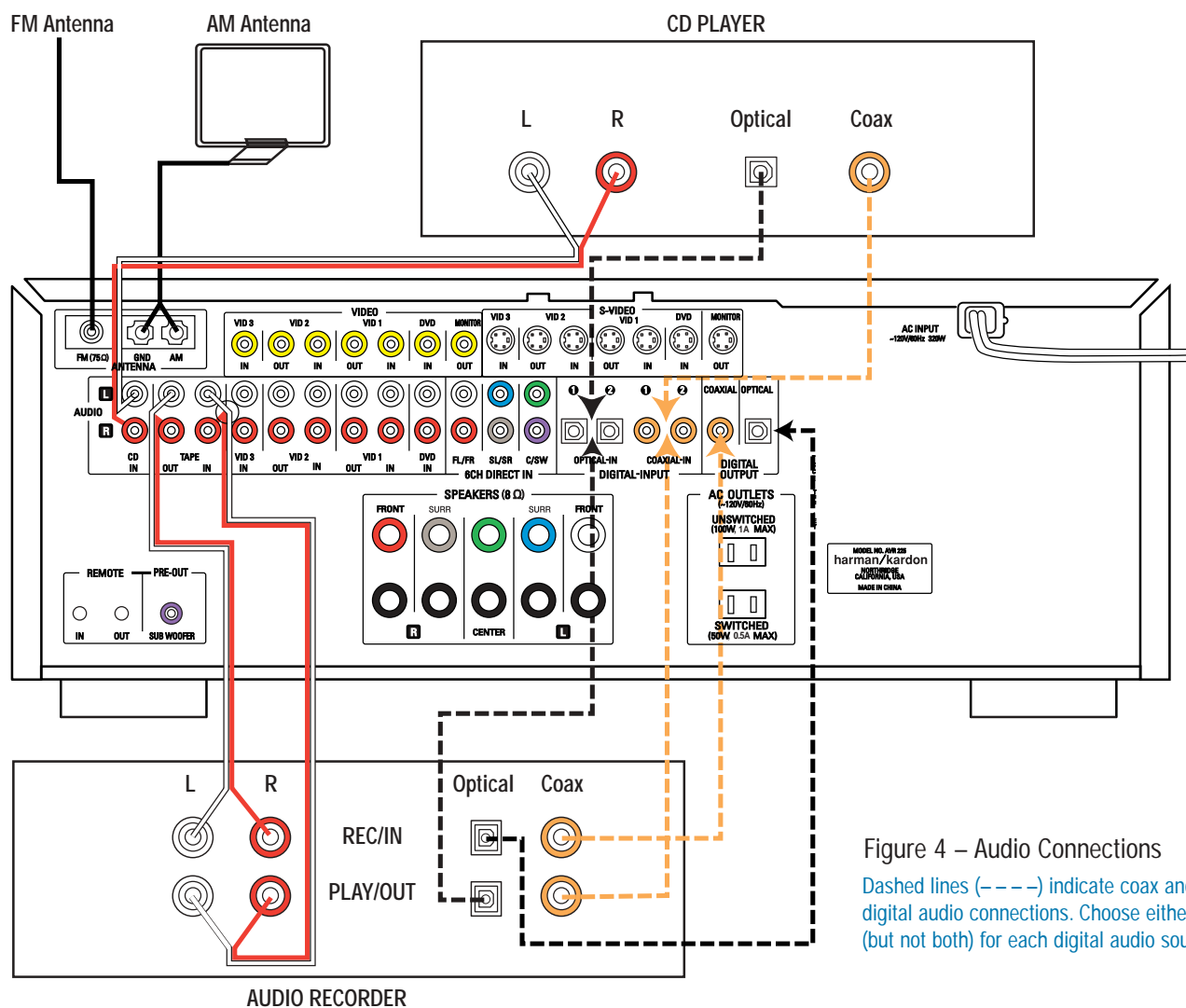

Figure 4 – Audio Connections

Dashed lines (---) indicate coax and optical digital audio connections. Choose either type (but not both) for each digital audio source.

Step 4. Connect AM and FM antennas (Figure 4).
(See page 14.)

Step 5. Connect source components, as shown in Figures 4 and 5, and the Device Connection Options chart at right (see pages 14–15).
AUDIO connections: right channel (red) on source to right (red) on AVR, and left channel (white) on source to left (white) on AVR.
DIGITAL AUDIO connections, if available: Choose either coax (orange) to coax (orange) OR optical to optical for each device. The Coax 1 input defaults to the DVD player, but may be reassigned. Assign the other digital inputs and outputs as appropriate for your equipment (as described in Step 7).
VIDEO connections: Choose either composite (yellow) or S-Video (4-pin) for each video source. Connect the composite and S-Video

Monitor outputs to your Video Monitor (TV). Switch your TV set's input to match the type of video used for the currently selected source.
Step 6. Plug all components into AC power outlets. The outlets on the back of the AVR 225 may be used *only* for low-current products, such as CD or DVD players, as long as the total does not exceed 100 watts.

Basic Receiver Configuration

Step 7. **Select digital inputs:** If your DVD is connected to Coax 1, no adjustment is needed. For any other digital-device connections, use the On-Screen In/Out Setup menu or the front-panel Digital Select button and the arrow buttons to select an optical or coax digital input (see pages 17–18 and 26).
Step 8. **Select a surround mode:** Press the Surround Mode button on the front panel to select

Dolby® Pro Logic® II – Movie. (You may select other modes later as you become familiar with the AVR 225; see pages 18 and 25–26.)

Step 9. **Configure speakers:** No action is needed if you have five "small" satellite-type speakers and a subwoofer. Otherwise, use the OSD Speaker Setup Menu, or press the Speaker button and then the Set and arrow buttons to select the correct speaker choices for your system (see pages 19–20).
Step 10. **Use EzSet™ to set output levels:** Set the Balance to 12 o'clock, and the Volume to –15dB. Hold the remote in front of you at shoulder level, and point it at the AVR 225. Press the SPL button for 3 seconds, hold the remote steady, and wait for the process to complete (see pages 21–22).
Step 11. Your system is configured – sit back and enjoy!

AVR 225 QUICK-START GUIDE

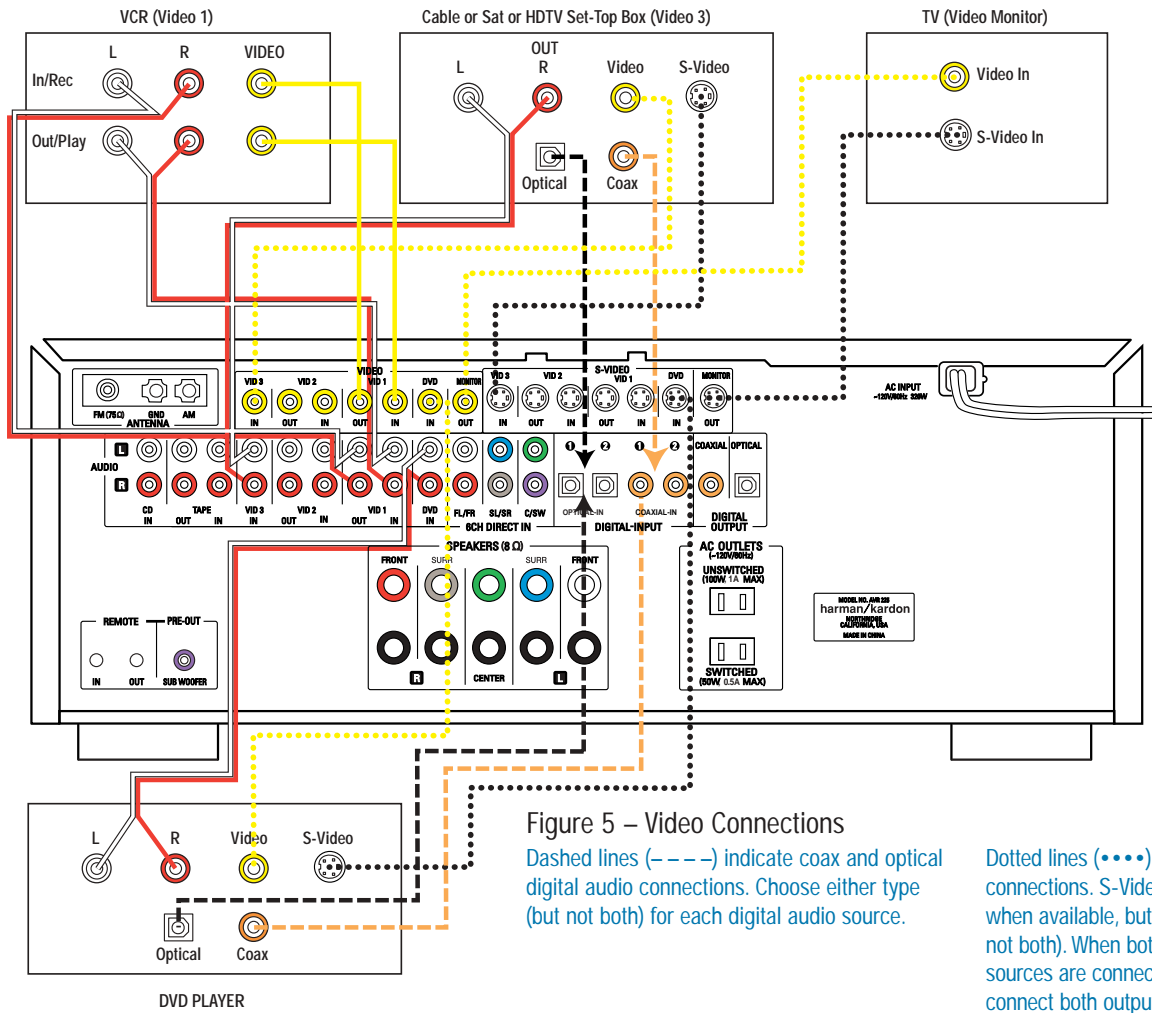

Figure 5 – Video Connections

Dashed lines (---) indicate coax and optical digital audio connections. Choose either type (but not both) for each digital audio source.

Dotted lines (•••) indicate composite or S-Video connections. S-Video is the preferred connection when available, but you may use either type (but not both). When both composite and S-Video sources are connected to the AVR you must also connect both outputs from the AVR to your TV.

Device Connection Options: Recommended connections are shown in red, but connections may be made to best fit your system requirements.				
Device	Input Name	Audio Input Connections	Audio Output Connections	Video Connections
CD Player	CD	CD L/R Inputs, Optical Digital 1 or 2, or Coaxial Digital 1 or 2	Not required	Not required
DVD Player	DVD	Coaxial Digital 1 or 2, Optical Digital 1 or 2, or DVD L/R Inputs	Not required	DVD Composite or S-Video
VCR	Video 1	Video 1 L/R Inputs	Video 1 L/R Outputs	Video 1 Composite or S-Video Input and Output
Cable Box or Satellite Receiver	Video 2 or 3	Video 2 or 3 L/R Inputs, Optical Digital 1 or 2, or Coaxial Digital 1 or 2 Inputs*	Not required	Video 2 or 3 Composite or S-Video Input
Video Game	Video 2, 3 or 4	Video 2, 3 or 4 L/R Inputs, Optical Digital 1, 2 or 3, or Coaxial Digital 1, 2 or 3 Inputs	Not required	Video 2, 3 or 4 Composite or S-Video Input
Camcorder	Video 2, 3 or 4	Video 2, 3 or 4 L/R Inputs	Video 2, or 3 L/R Outputs	Video 2, 3 or 4 Composite or S-Video Input and Output
Audio Cassette Recorder	Tape	Tape L/R Inputs	Tape L/R Outputs	Not required
Digital Audio Recorder	Tape and/or CD	Tape L/R Inputs, Optical Digital 1/2 or Coaxial Digital 1/2 Inputs	Tape L/R Outputs, Digital Optical or Coaxial Outputs	Not required
TV or Projector	Video 2 or 3	Video 2 or 3 L/R Inputs	Not required	Monitor-Out Composite and/or S-Video

*Check with your cable company to make certain that digital audio is available for all channels. It may be necessary to make BOTH analog and digital connections.

read first! Important Safety Precautions!



CAUTION
RISK OF ELECTRIC SHOCK
DO NOT OPEN



CAUTION: To reduce the risk of electric shock, do not remove cover (or back) no user-serviceable parts inside refer servicing to qualified service personnel.



The lightning flash with arrowhead symbol, within an equilateral triangle, is intended to alert the user to the presence of uninsulated "dangerous voltage" within the product's enclosure that may be of sufficient magnitude to constitute a risk of electric shock to persons.



The exclamation point within an equilateral triangle is intended to alert the user to the presence of important operating and maintenance (servicing) instructions in the literature accompanying the appliance

- 1. Read Instructions.** All the safety and operating instructions should be read before the product is operated.
- 2. Retain Instructions.** The safety and operating instructions should be retained for future reference.
- 3. Heed Warnings.** All warnings on the product and in the operating instructions should be adhered to.
- 4. Follow Instructions.** All operating and use instructions should be followed.
- 5. Cleaning.** Unplug this product from the wall outlet before cleaning. Do not use liquid cleaners or aerosol cleaners. Use a damp cloth for cleaning.
- 6. Attachments.** Do not use attachments not recommended by the product manufacturer, as they may cause hazards.
- 7. Water and Moisture.** Do not use this product near water—for example, near a bathtub, wash bowl, kitchen sink or laundry tub; in a wet basement; near a swimming pool; or the like.
- 8. Accessories.** Do not place this product on an unstable cart, stand, tripod, bracket or table. The product may fall, causing serious injury to a child or adult, and serious damage to the product. Use only with a cart, stand, tripod, bracket or table recommended by the manufacturer, or sold with the product. Any mounting of the product should follow the manufacturer's instructions, and should use a mounting accessory recommended by the manufacturer.
- 9. A Product and Cart Combination Should Be Moved with Care.** Quick stops, excessive force and uneven surfaces may cause the product and cart combination to overturn.
- 10. Ventilation.** Slots and openings in the cabinet are provided for ventilation and to ensure reliable operation of the product and to protect it from overheating, and these openings must not be blocked or covered. The openings should never be blocked by placing the product on a bed, sofa, rug or other similar surface. This product should not be placed in a built-in installation, such as a bookcase or rack, unless proper ventilation is provided or the manufacturer's instructions have been adhered to.



11. Power Sources. This product should be operated only from the type of power source indicated on the marking label. If you are not sure of the type of power supply to your home, consult your product dealer or local power company. For products intended to operate from battery power, or other sources, refer to the operating instructions.

12. Polarization. This product may be equipped with a polarized alternating-current-line plug (a plug having one blade wider than the other). This plug will fit into the power outlet only one way. This is a safety feature. If you are unable to insert the plug fully into the outlet, try reversing the plug. If the plug should still fail to fit, contact your electrician to replace your obsolete outlet. Do not defeat the safety purpose of the polarized plug.

13. Power-Cord Protection. Power-supply cords should be routed so that they are not likely to be walked on or pinched by items placed upon or against them, paying particular attention to cords at plugs, convenience receptacles, and the point where they exit from the product.

14. Nonuse Periods. The power cord of the product should be unplugged from the outlet when left unused for long periods of time.

15. Outdoor Antenna Grounding. If an outside antenna or cable system is connected to the product, be sure the antenna or cable system is grounded so as to provide some protection against voltage surges and built-up static charges. Article 810 of the National Electrical Code, ANSI/NFPA 70, provides information with regard to proper grounding of the mast and supporting structure, grounding of the lead-in wire to an antenna discharge unit, size of grounding conductors, location of antenna-discharge unit, connection to grounding electrodes, and requirements for the grounding electrode. See Figure 1.

16. Lightning. For added protection for this product during a lightning storm, or when it is left unattended and unused for long periods of time, unplug it from the wall outlet and disconnect the antenna or cable system. This will prevent damage to the product due to lightning and power-line surges.

17. Power Lines. An outside antenna system should not be located in the vicinity of overhead power lines or other electric light or power circuits, or where it can fall into such power lines or circuits. When installing an outside antenna system, extreme care should be taken to keep from touching such power lines or circuits, as contact with them might be fatal.

18. Overloading. Do not overload wall outlets, extension cords, or integral convenience receptacles, as this can result in a risk of fire or electric shock.

19. Object and Liquid Entry. Never push objects of any kind into this product through openings, as they may touch dangerous voltage points or short-out parts that could result in a fire or electric shock. Never spill liquid of any kind on the product.

20. Servicing. Do not attempt to service this product yourself, as opening or removing covers may expose you to dangerous voltage or other hazards. Refer all servicing to qualified service personnel.

21. Damage Requiring Service. Unplug this product from the wall outlet and refer servicing to qualified service personnel under the following conditions:

- a. The power-supply cord or the plug has been damaged; or
- b. Objects have fallen onto, or liquid has been spilled into, the product; or
- c. The product has been exposed to rain or water; or
- d. The product does not operate normally when following the operating instructions. Adjust only those controls that are covered by the operating instructions, as an improper adjustment of other controls may result in damage and will often require extensive work by a qualified technician to restore the product to its normal operation; or
- e. The product has been dropped or damaged in any way; or
- f. The product exhibits a distinct change in performance; this indicates a need for service.

22. Replacement Parts. When replacement parts are required, be sure the service technician has used replacement parts specified by the manufacturer or that have the same characteristics as the original part. Unauthorized substitutions may result in fire, electric shock or other hazards.

23. Safety Check. Upon completion of any service or repairs to this product, ask the service technician to perform safety checks to determine that the product is in proper operating condition.

24. Wall or Ceiling Mounting. The product should be mounted to a wall or ceiling only as recommended by the manufacturer.

25. Heat. The product should be situated away from heat sources such as radiators, heat registers, stoves or other products (including amplifiers) that produce heat.

Figure 1.
Example of Antenna Grounding as per National Electrical Code ANSI/NFPA 70

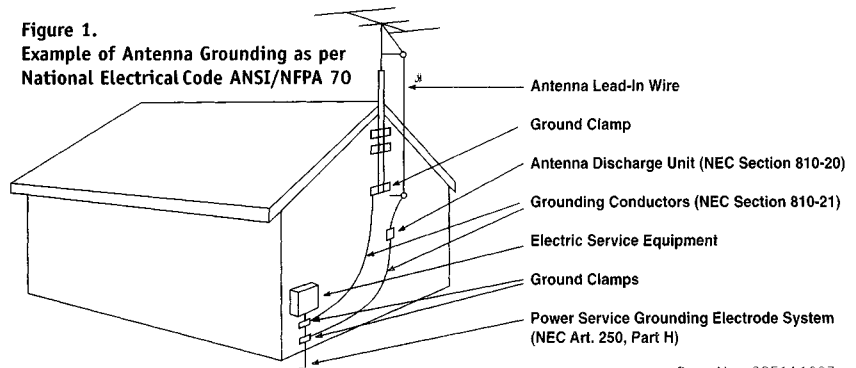

harman/kardon Limited Warranty

The Harman Kardon products listed below are warranted for the period stated from the date of original purchase.

- | | |
|--------------------------------------|---------|
| • Receivers, Tuners and Amplifiers | 2 Years |
| • Cassette Decks | 1 Year |
| • Compact Disc Players and Recorders | 1 Year |
| • DVD Players | 1 Year |

WHO IS PROTECTED BY THIS WARRANTY

Your Harman Kardon warranty protects the original owner of a Harman Kardon product, provided that the product was purchased within the continental United States, Alaska or Hawaii from an authorized dealer who was authorized by Harman Kardon to sell such products at the time of the original purchase, or was purchased by military personnel from an authorized military outlet. Warranty service is available only in the country of original purchase. For warranty information outside the continental United States, Alaska or Hawaii, please contact your local dealer or distributor. Warranty service is available as long as the original bill of sale is presented when warranty service is required. Please attach a copy of your bill of sale to this warranty statement and put it in a safe place.

WHAT IS COVERED

Your Harman Kardon warranty covers all defects in material and workmanship with the following specified exceptions: (1) damage caused by accident, unreasonable use or neglect (including the lack of reasonable and necessary maintenance); (2) damage occurring during shipment (claims must be presented to the carrier); (3) damage to, or deterioration of, any accessory or decorative surface; (4) damage resulting from failure to follow instructions contained in your owner's manual; (5) damage resulting from the performance of repairs by someone other than an authorized Harman Kardon warranty station; (6) any Harman Kardon unit on which the serial number has been effaced, modified or removed; (7) units used for other than home use. This warranty covers only actual defects within the product itself, and does not cover the cost of installation or removal from a fixed installation, normal set-up or adjustments, claims based on misrepresentation by the seller or performance variations resulting from installation-related circumstances such as source quality or AC power.

HOW TO OBTAIN WARRANTY SERVICE

If your Harman Kardon product ever needs service, please return the product to your dealer. If this is not possible and you live in the continental United States, Alaska or Hawaii, please visit our Web site at www.harmankardon.com, or call 1-800-422-8027 for the location of the nearest warranty station, or write to Harman Kardon, Incorporated, 250 Crossways Park Drive, Woodbury, NY 11797 (Attention: Customer Service). You'll need to present your original bill of sale to the warranty station to establish the date of purchase.

WHO PAYS FOR WHAT

Harman Kardon will pay all expenses for labor and materials for all repairs covered by this warranty. If necessary repairs are not covered by this warranty, or if a unit is examined which is not in need of repair, you will be charged for the repairs or examination.

The owner must pay any shipping charges incurred in getting your Harman Kardon product to a Harman Kardon Authorized Warranty Station located within the continental United States, Alaska or Hawaii. We will pay reasonable return shipping charges to any location in the continental United States, Alaska or Hawaii if the repairs are covered under the warranty. Please be sure to save the original shipping carton(s), because a charge will be made for additional cartons.

INFORMATION

If you have questions regarding the installation or operation of this unit, please call Customer Service at 1-800-422-8027, or e-mail us at websupport@harman.com, or write to us at Harman Kardon, Incorporated, 250 Crossways Park Drive, Woodbury, NY 11797 (Attention: Customer Service).

**LIMITATION ON IMPLIED WARRANTIES
IMPLIED WARRANTIES OF MERCHANTABILITY
AND FITNESS FOR PARTICULAR PURPOSE
ARE LIMITED IN DURATION TO THE LENGTH
OF THIS WARRANTY, UNLESS OTHERWISE
PROVIDED BY STATE LAW.**

**EXCLUSION OF CERTAIN DAMAGES
HARMAN KARDON'S LIABILITY IS LIMITED TO
THE REPAIR OR REPLACEMENT, AT OUR
OPTION, OF ANY DEFECTIVE PRODUCT AND
SHALL IN NO EVENT INCLUDE INCIDENTAL OR
CONSEQUENTIAL DAMAGES OF ANY KIND.**

**SOME STATES DO NOT ALLOW LIMITATIONS
ON HOW LONG AN IMPLIED WARRANTY
LASTS AND/OR DO NOT ALLOW THE EXCLU-
SION OF INCIDENTAL OR CONSEQUENTIAL
DAMAGES, SO THE ABOVE LIMITATIONS
MAY NOT APPLY TO YOU.**

This warranty gives you specific legal rights, and you may also have other rights which vary from state to state.

We sincerely thank you for your expression of confidence in Harman Kardon products. This equipment has been painstakingly assembled by highly trained craftspeople. It should give you many years of musical enjoyment.

harman/kardon[®]

8500 Balboa Blvd., Northridge, CA 91329
250 Crossways Park Drive, Woodbury, NY 11797

Free Manuals Download Website

<http://myh66.com>

<http://usermanuals.us>

<http://www.somanuals.com>

<http://www.4manuals.cc>

<http://www.manual-lib.com>

<http://www.404manual.com>

<http://www.luxmanual.com>

<http://aubethermostatmanual.com>

Golf course search by state

<http://golfingnear.com>

Email search by domain

<http://emailbydomain.com>

Auto manuals search

<http://auto.somanuals.com>

TV manuals search

<http://tv.somanuals.com>