

# TRANSFORMERS



**AGES 5+**  
83805/81057 Asst.



**WARNING:**

CHOKING HAZARD-Small parts.  
Not for children under 3 years.

NOTE: Some parts are made to detach if excessive force is applied and are designed to be reattached if separation occurs. Adult supervision may be necessary for younger children.

**BARRICADE**  
DECEPTICON

TRANSFORMERS.COM

## CHANGING TO ROBOT

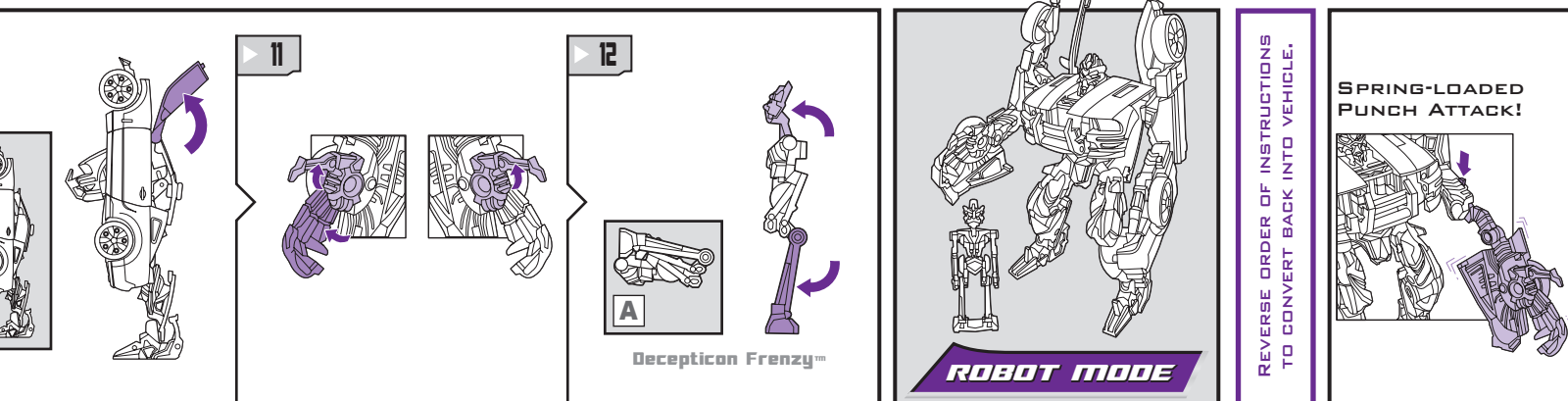
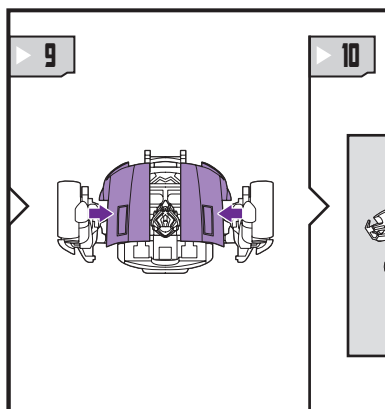
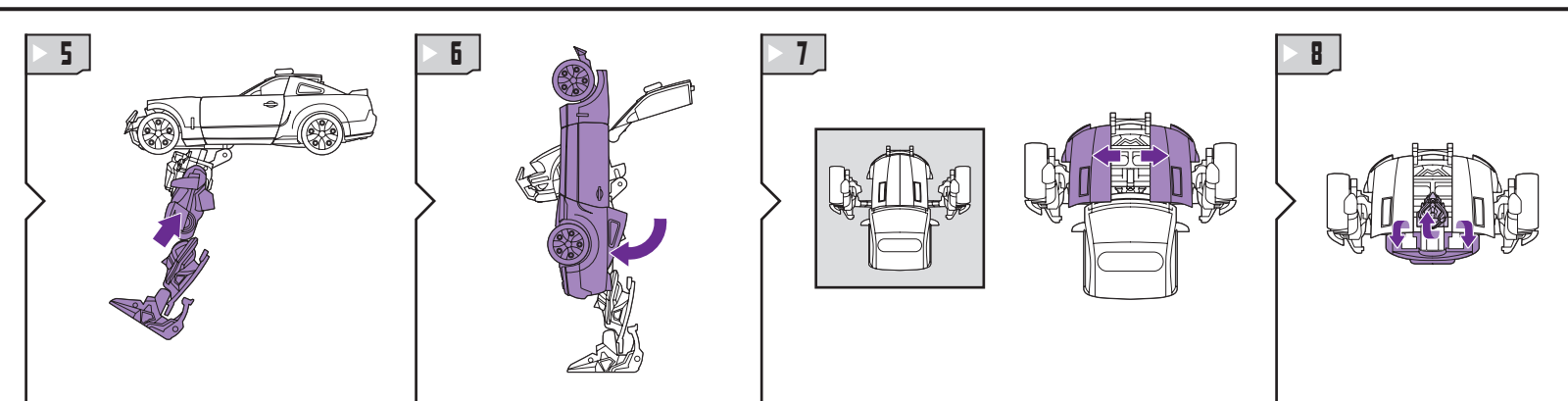
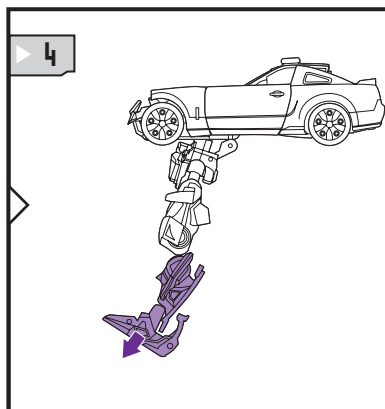
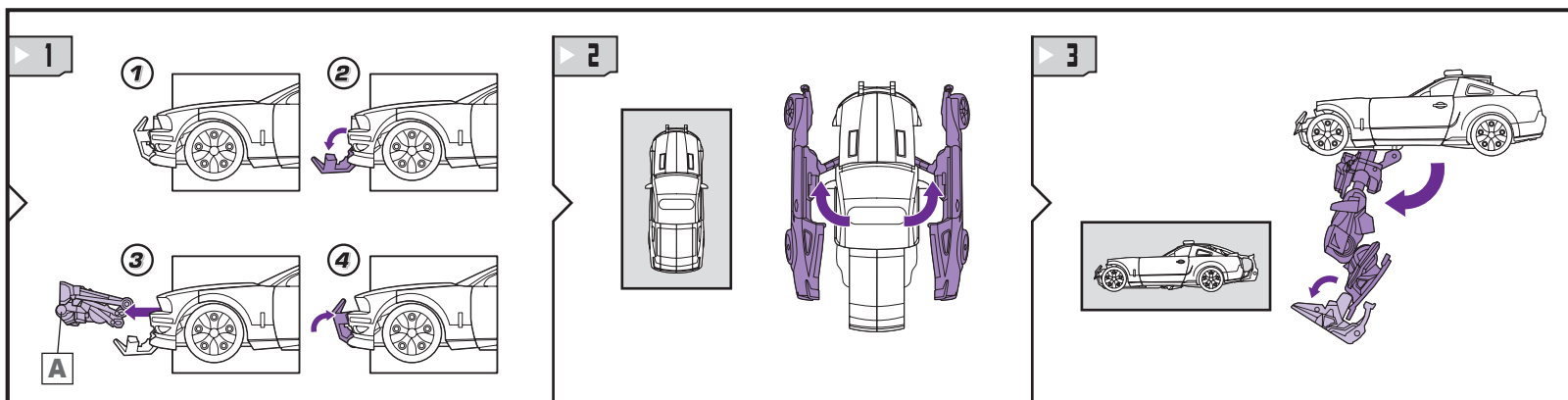
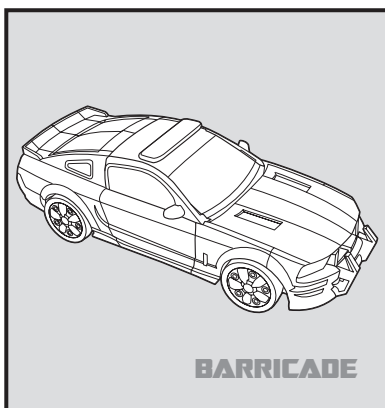

REVERSE ORDER OF INSTRUCTIONS  
TO CONVERT BACK INTO VEHICLE.

SPRING-LOADED  
PUNCH ATTACK!

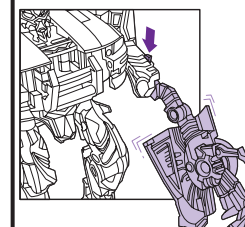

TRANSFORMERS.COM

Some poses may require hand support.

P/N 6777510000



© 2007 DreamWorks LLC and Paramount Pictures Corporation  
®\* and/or TM\* & © 2007 Hasbro. All rights reserved.  
TM & © denote U.S. trademarks.  
Manufactured under license from Tomy Company, Ltd.



Download from Www.Somanuáls.com. All Manuals Search And Download.



Not suitable for children  
under 3 years because of  
small parts - choking hazard.



Saleen® and S281 are  
registered trademarks  
of Saleen Inc. used  
under license.

## Free Manuals Download Website

<http://myh66.com>

<http://usermanuals.us>

<http://www.somanuals.com>

<http://www.4manuals.cc>

<http://www.manual-lib.com>

<http://www.404manual.com>

<http://www.luxmanual.com>

<http://aubethermostatmanual.com>

Golf course search by state

<http://golfingnear.com>

Email search by domain

<http://emailbydomain.com>

Auto manuals search

<http://auto.somanuals.com>

TV manuals search

<http://tv.somanuals.com>