

The Art of Hasty-Baking

Owner's Guide & Instruction Manual



Safety

When using your Hasty-Bake oven, please observe the following cautions to ensure that your outdoor cooking experiences are happy and safe.

- ⚠️ Hasty-Bake ovens are designed for outdoor use. If used in an enclosed area, proper ventilation must be provided. Otherwise, toxic fumes will accumulate and cause serious bodily injury or death.
- ⚠️ Do not add charcoal starter fluid or charcoal impregnated with charcoal lighter fluid to hot or warm coals. Cap starter fluid after using and place a safe distance away from the oven.
- ⚠️ Do not use gasoline, alcohol or other highly volatile fluids to ignite charcoal.
- ⚠️ Do not leave infants, children or pets unattended near a hot oven.
- ⚠️ Do not attempt to move a hot oven.
- ⚠️ Do not use your Hasty-Bake oven within five feet of any combustible material.
- ⚠️ Do not remove ashes until all coals are completely burned out and are fully extinguished.
- ⚠️ Do not wear clothing with loose flowing sleeves while lighting or using the oven.
- ⚠️ Do not use your Hasty-Bake oven in high winds.
- ⚠️ Do not store combustible materials (charcoal, Firelighters, etc.) in the storage area under the ash pan while using the oven.
- ⚠️ Keep the oven in a level position at all times.
- ⚠️ Open the lid of the oven while lighting and getting the coals started.
- ⚠️ Never touch the cooking or charcoal grates, or the oven, to see if they are hot.
- ⚠️ Barbecue mitts or hot pads should always be used to protect hands while barbecuing, opening the fire door or adjusting the dual draft vents.
- ⚠️ Use proper barbecue tools with long, heat-resistant handles.
- ⚠️ To extinguish coals, close the hood, fire door and dual draft vents. Do not use water.
- ⚠️ To control flare ups, close the hood and, if necessary, the fire door and dual draft vents. Do not use water.
- ⚠️ Handle and store hot electric starters carefully.
- ⚠️ Keep electrical cords away from the hot surfaces of the oven.
- ⚠️ Using sharp objects to clean the cooking grill or remove ashes will damage the finish.
- ⚠️ Using abrasive cleaners on the cooking grill or the oven itself will damage the finish.

WARRANTY

Powder-Coated Finish Models (131, 414)

1 year warranty on paint
5 year warranty on parts and workmanship

Dual Finish Models (256, 83)

1 year warranty on paint
5 year warranty on parts and workmanship
10 year warranty on stainless steel components

Stainless Steel Models (132, 415, 257, 84, 270, 369)

10 year warranty on parts and workmanship

Shipping and handling extra



Table of Contents

Welcome.....	2
A Little History.....	3
Unique Features & Benefits	4 - 5
Assembly Instructions	
Suburban/Continental/Legacy/Gourmet.....	6 - 7
Parts Diagrams	
Fiesta & Portable.....	8
Caring for your Hasty-Bake	9
Cooking Methods	10 - 11
Getting Started.....	12
Cooking Tips.....	13
Installing a Rotisserie	14
Trouble Shooting & Common Questions	15
Recipes	16 - 26
What is Hardwood Charcoal?	27
Hasty-Bake Accessories	28 - 29

Welcome

Dear Hasty-Bake owner,

Congratulations and welcome to the proud Hasty-Bake family. I am confident that you will be pleased with your decision to purchase the finest multipurpose charcoal-burning grill available.

Whether you are a “seasoned” outdoor chef or just getting “fired-up”, the following pages will provide you with helpful tips, tricks, and techniques to make your Hasty-Bake experiences more enjoyable. We have also included a collection of our favorite recipes to get you started (we hope you like them as much as we do!).

We sincerely appreciate your business and look forward to serving all of your outdoor cooking needs. Please do not hesitate to contact us if you have any questions or comments about “The Art of Hasty-Baking”. We would love to hear from you.

Best regards,



Richard Alexander
President



A Little History

In 1948, Grant Hastings produced the first Hasty-Bake Charcoal Oven. As one of the original manufacturers of the “backyard barbecue,” Hastings was a pioneer in the industry. Specifically, Hasty-Bake introduced the first portable unit, the first hooded unit, and a new method of cooking using indirect heat. Hastings’ design controlled the intensity of heat by using vents, a heat deflector, a ventless hood and an adjustable firebox, revolutionizing the method in which food was cooked.

In acknowledgment of Grant Hastings tremendous efforts, Hasty-Bake Charcoal Ovens have attracted a lot of attention over the years. Hasty-Bake was selected by the State Department to represent the United States at the Brussels World’s Fair in 1958. Our company won the Hess Award in 1962, and our ovens have been on display in the Chicago Museum of Science and Industry. The patented Hasty-Bake design receives continual praise from food and industry critics across the country.

In addition, our ovens have produced blue ribbon results in barbecue competitions from coast to coast. For example, the Grand Champion of the 1994 American Royal in Kansas City (known as the World Series of Barbecue Cookoffs), Doug Steele and his Heat’s Neat team, used a Hasty-Bake to prepare most of their award-winning recipes.

Though our company has undergone many changes in the last 50 years, the basic design of Hasty-Bake Charcoal Ovens remains unchanged. Since 1993, Hasty-Bake has been owned by Richard and Bill Alexander. They have continued the tradition of producing the finest multipurpose charcoal-burning grill available on the market today.

Built for the discriminating outdoor chef, Hasty-Bake ovens create a cooking environment that produces meals which are superior in taste. No other product has the versatility to grill, bake and smoke with such ease and perfection. Each Hasty-Bake is constructed by hand from only the highest-quality materials. With proper care and basic maintenance, you can expect our black powder finish, cold-rolled steel ovens to last for 15 to 25 years (or longer). Our solid stainless steel models can be expected to last virtually forever!

Even after 50 years, our charcoal ovens continue to grow in popularity, largely thanks to proud owners who tell others about their Hasty-Baking experiences. Since satisfied customers have always been our best advertising, we hope you will carry on the Hasty-Bake tradition by sharing your enthusiasm with others.

Unique Features & Benefits

VENTLESS HOOD (7)

Your Hasty-Bake has a hinged hood so you can cook with the hood open or closed. The deep “ventless” hood is just one of the unique features which enables you to prepare foods which are flavorful and juicy (draft vents placed in the hood of a grill will dry out foods). The main function of your Hasty-Bake hood is to hold in the heat and smoke so that it rotates around your food. Your Hasty-Bake cooks like an oven; it turns the heat instead of you having to turn the meat.

DUAL DRAFT VENTS (8)

Dual draft vents, combined with the adjustable fire box and Hasty-Bake’s totally enclosed design, provide you with the ability to control the fire at all times. The intake draft vent is located on the fire door, just below the fire level. The exhaust draft vent is located above the fire level on the opposite side of the grill, by the push handle. Hasty-Bake’s unique dual draft vent feature creates a cross draft in the body of the oven, instead of in the hood, which allows your foods to be cooked on all sides. Fully opened vents create an intense heat. Conversely, vents that are barely open lower the heat for baking and smoking.

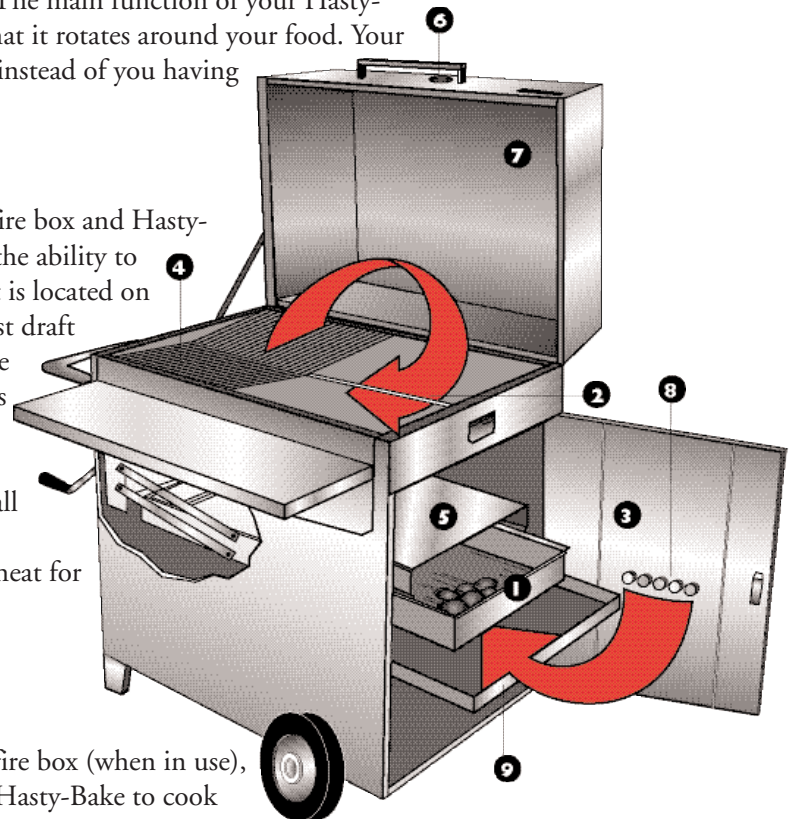

HEAT DEFLECTOR (5)

The heat deflector plate, which is placed on the fire box (when in use), combines with the ventless hood to enable your Hasty-Bake to cook like an oven. The heat deflector’s function is to distribute heat evenly throughout the cooking area without exposing any food to the direct fire and to control flare-ups. Thus, your Hasty-Bake becomes a “convection” oven and your food can be placed across the entire cooking surface. For the heat deflector to work properly, confine the coals to not more than half of the fire box (usually the right hand side, which is the side of the fire box closest to the fire door) and slide the heat deflector into place on top of the fire box above the coals. Remember to remove the heat deflector when using your Hasty-Bake for cooking with direct heat (searing).

FULL-WIDTH FIRE DOOR (3)

On all Hasty-Bake models, a full width door permits easy fueling and allows the fire box and ash pan to be entirely removed for cleaning. The full-width fire door also makes it easy to slide the heat deflector into place or remove it when necessary. In addition, the fire door makes it easy to access the fire box for refueling during slow cooking or smoking so that foods never have to be removed from the grill. Use the space at the bottom of the oven base (below the ash pan) as a warming area while cooking and a storage area when your Hasty-Bake is not in use.

ASH PAN (9)

All Hasty-Bake models feature a completely removable ash pan, making clean up easy. When the fire box is pulled out for refueling, remember to pull the ash pan out simultaneously to catch the charcoal ashes and cinders that may fall through the fire grate. To help reduce corrosion and to keep clean-up simple, we recommend that you line the ash pan with heavy-duty aluminum foil.

COOKING GRILLS (4)

Our cooking grills are constructed of heavy $\frac{1}{4}$ " diameter nickel-plated material providing a clean, durable cooking surface. The grills are also "V"-shaped, allowing grease to flow to the center of the cooking grill and travel properly through the grease drain system.

GREASE DRAIN SYSTEM (2)

The "V"-shaped cooking grills encourage most of the grease and fat to drain off of the meat, follow the "V" toward the center of the cooking grill, drip into the grease drain rod and continue outside the unit to the grease cup. Flare-ups are virtually eliminated. Typically, when the hood is closed and the heat deflector is in place, grease drippings will not cause flare-ups. If you are "searing" or "grilling" your food with the hood open and the heat deflector removed, flare-ups might occur. You can control them by simply closing the hood and draft vents for a few seconds.

ADJUSTABLE FIRE BOX & COOKING STYLE INDICATOR (1)

The position of your fire may be mechanically adjusted up or down. Turning the outside crank handle clockwise raises the fire box to the "sear" position for quick cooking of steaks, burgers, etc. Turning the crank handle counterclockwise lowers the fire box to a "bake" level for cooking chicken, ham, bread, etc. Continue turning the crank handle counterclockwise and the fire will be in the "smoke" position, for slow cooking or smoking of turkeys, ribs, briskets, etc. Read the information above about the heat deflector for proper use with the adjustable fire box. The cooking style indicator on the front of the Hasty-Bake is linked to the lift mechanism and eliminates any guess work about the position of the fire. Different cooking methods require varying placements of the fire.

Because the fire box (instead of the cooking grills) may be moved up or down, the cooking space inside the hood remains unchanged during fire box adjustments. This is important when cooking large turkeys, hams or both.

THERMOMETER (6)

Accurate to within 1%, this stainless steel bi-metal thermometer helps you maintain your desired cooking temperature.

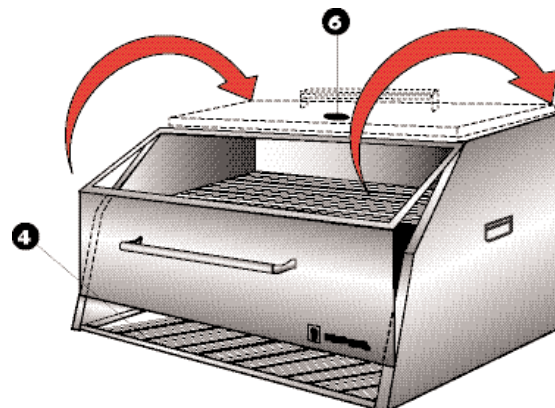
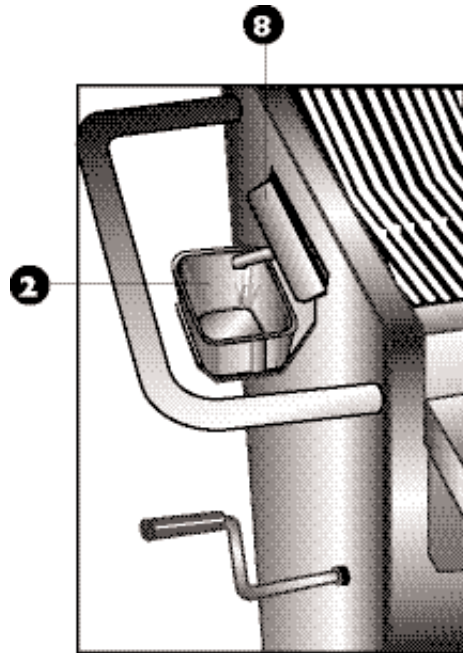

Assembly Instructions

Suburban/Continental/Legacy/Gourmet

Your new Hasty-Bake oven should arrive almost fully assembled. However, a few items are left unassembled for ease of shipping or loading into vehicles. The unit is not difficult to assemble and there are only two tools needed for assembly: a Phillips screwdriver and a crescent wrench. If you have any problems assembling your Hasty-Bake, please call 1-800-4AN-OVEN.

1

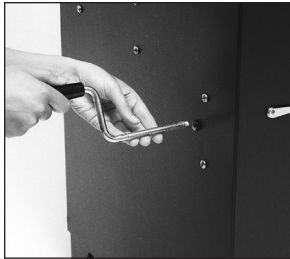

CRANK HANDLE

Screw the crank handle into threaded hole on the left side of the oven (the side of the oven opposite the full-width fire door) and continue to turn until the lift mechanism is moving up and down.

2

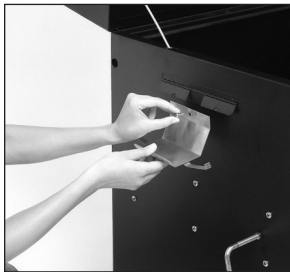

GREASE CUP HOLDER

Attach the grease cup holder to the left side of the cabinet base using either the top or bottom rotisserie bracket mounting holes located at the center of the oven, directly below the draft vents. The bolt, nut and lockwasher should already be attached to the grill base. Leave the remaining bolt in place to plug the unused hole. (These same bolts are also used to mount the rotisserie should you purchase one for your grill.) Place the grease cup on the holder and bend the arms to fit around the foil cup.

3

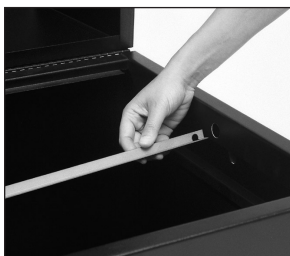

GREASE DRAIN ROD

Insert the grease drain rod into the unit. The rod should be positioned with the notched hole inserted into the retaining hole, which is located on the inside of the oven, centered and directly above the fire door on the right side of the unit. For the drainage system to operate properly, DO NOT insert the rod into the rotisserie spit rod hole on the oven base. The end of the rod without the notched hole extends through the center draft hole on the left side of the unit and hangs over the foil cup, positioned on the outside of the grill.

4



PUSH HANDLE

The push handle fits into holes located on the left side of the unit. This is a "friction fit", so work on one side at a time, rotating the handle into the holes. After you have worked the handle partially into both holes, push the handle in completely. Attach with the four larger bolts, lockwashers, and nuts provided in the bag. If your push handle is delivered with a side work table in place, installation will be easier if the work table is removed first. Once the handle is bolted in place, snap the table back on. NOTE: Lift and push your Hasty-Bake with this handle, DO NOT pull the unit behind you.

5

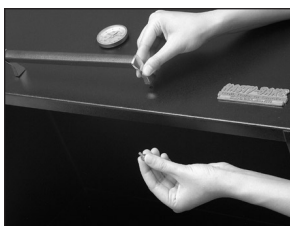

HOOD HANDLE

Attach the hood handle with the two small bolts and lockwashers provided in the bag.

COOKING GRILLS

The two cooking grills sit on lips positioned near the top of base cabinet along the front and back sides. Set grills with “V” facing down.

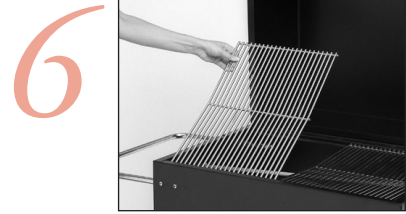

FIRE GRATE

Place the fire grate into the bottom of the fire box.



FIRE BOX

The fire box slides into the channels on the lift mechanism, which is located inside the unit above the ash pan.



ASH PAN

The ash pan slides into support runners on each side of the cabinet base.



HEAT DEFLECTOR

The heat deflector slides over and rests on the lift mechanism rails above the fire box. It can be moved along the length of the fire box or removed and stored elsewhere, depending on your chosen cooking method. NOTE: If the fire box is raised to the highest position (“sear”) with the heat deflector in place, the grease drain rod will bend.



FRONT WORK TABLE

The stainless steel front work table simply rests on the front of the oven base. The table must be removed and stored, either in the grill or in the storage area under the ash pan, for your Hasty-Bake grill cover to fit.

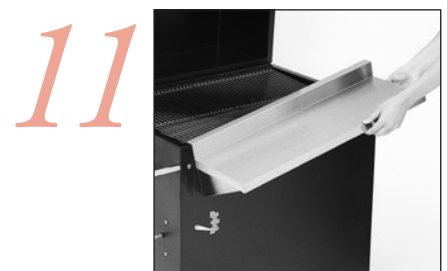

Parts Diagrams

FIESTA

1. Fire box
2. Grease drain system
3. Full-width fire door
4. Cooking grills
5. Heat deflector
6. Thermometer
7. Ash pan

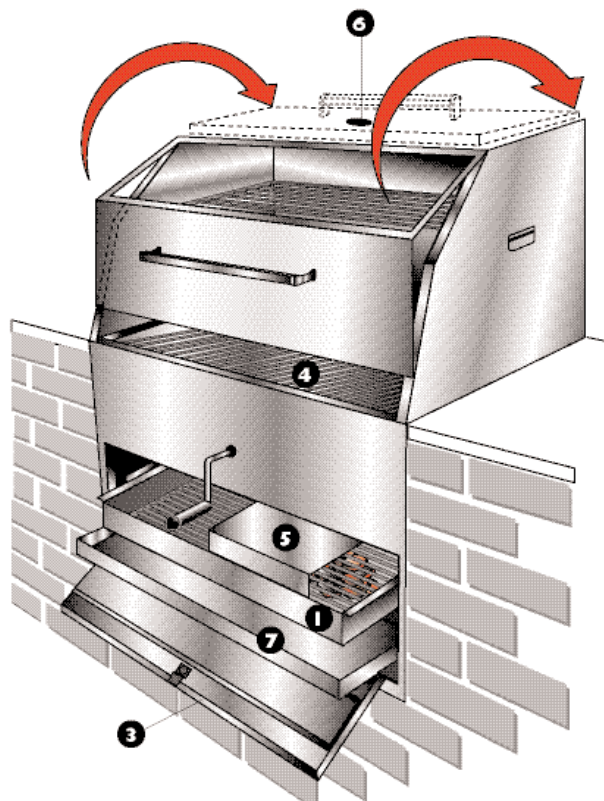
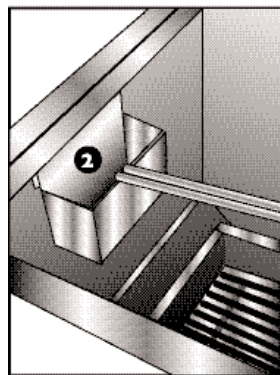

PORTABLE

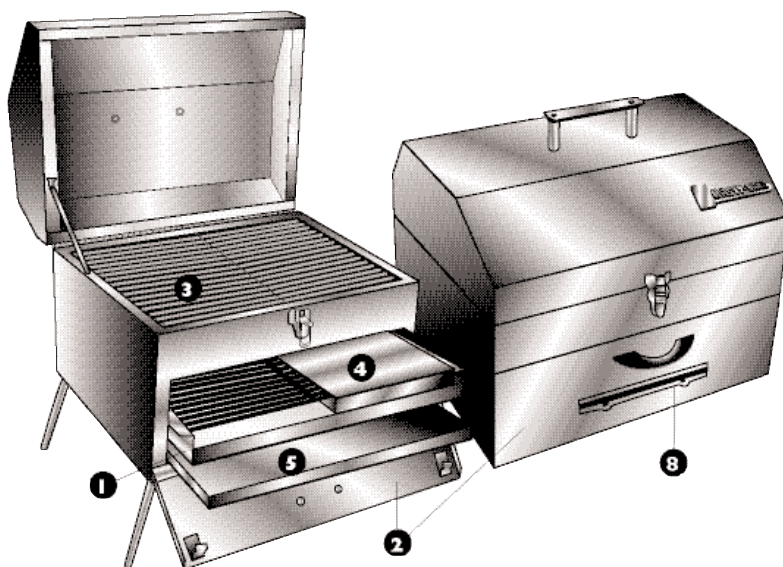

1. Fire box
2. Full-width fire door
3. Cooking grills
4. Heat deflector
5. Ash pan

Note: Since your new Portable grill is completely assembled, all you need to do is put the cooking grill in the proper position.

The fire door can be adjusted to open easier or close tighter simply by slightly bending the fire door clips up or down. Over time, heat from usage may require the clips to be adjusted periodically.

Caring for your Hasty-Bake

Constructed by hand, each Hasty-Bake unit contains only the highest-quality materials to provide unequaled performance, convenience and durability. With proper care and basic maintenance, you can expect our black powder finish, cold-rolled steel ovens to last for 15 to 25 years (or longer). Our solid stainless steel models can be expected to last virtually forever!

LINE YOUR ASH PAN WITH ALUMINUM FOIL.

This makes clean-up easy and provides a barrier between the caustic ashes and your ash pan, increasing the life of your ash pan.

AVOID EXCESSIVE HEAT.

Be aware that operating your Hasty-Bake at extremely high temperatures can damage the paint and other components of your grill and may void the warranty.

DON'T FORCE THE CRANK HANDLE IF IT IS TOO TIGHT.

Keep the crank handle lubricated for smooth operation. If the handle won't turn, check for obstructions. If there are no visible problems and the threads are lubricated, then call us. Always remember to store the heat deflector if you are using the "sear" position, the heat deflector will bend the grease drain rod.

LOWER YOUR FIRE BOX AFTER EACH USE.

The heat build-up from cooking on your Hasty-Bake can cause the lift mechanism to warp if left to cool in a raised position.

PROTECT YOUR INVESTMENT.

Excess moisture can shorten the life expectancy of your Hasty-Bake. So, try to remember to keep your oven out of the elements by either storing it in a covered area or by using one of our grill covers (a black cover silk-screened with the Hasty-Bake logo, made of Sunbrella™ material). NOTE: Never cover your Hasty-Bake while the oven is still hot and do not use a plastic cover.

TIPS FOR CLEANING YOUR HASTY-BAKE

Empty ashes frequently (if not before every use) to avoid having them spill over the sides of the ash pan. Also, be sure to remove any ashes that may fall below the ash pan into the storage area. Ashes draw moisture, creating a chemical reaction, which promotes rust.

Scrape the grease drain rod (after every cooking usage) to keep the grease drain system functioning efficiently and to control and virtually eliminate flare-ups.

Scrape off excessive grease build up on the interior of the oven (periodically) with a putty knife to avoid obstruction of moving parts. Excessive grease build up can hinder many of the movable parts (ash pan, fire box, heat deflector) which can lead to grease fires.

Clean the outside of your Hasty-Bake. Use a 3M Scotch-Brite pad and degreaser such as a Simple Green to clean the outer surface of the powder-coated finished parts. For stainless steel parts, use sudsy ammonia. We also carry a stainless steel cleaning product which helps keep stainless steel products looking shiny and new.

Clean the window on Gourmet and Continental models by applying sudsy ammonia or another degreasing cleaner. Allow the window to soak for a minute or two and scrape off any build-up with a razorblade tool.

Cooking Methods

Hasty-Bake Charcoal Ovens are proven award-winning smokers, but are much more versatile than traditional smokers, allowing you to grill, bake and smoke, all on the same unit!

DIRECT COOKING

Direct cooking is done by cooking foods directly over hot coals with the hood either open or closed. This method is also called searing, grilling or even frying. The fire box is generally raised to the highest position ("sear" on the cooking style indicator), or 4 to 6 inches below the cooking grills. The heat deflector should be removed when using this cooking method. Remember, that the meat must be turned since it will cook faster on the side that is directly over the fire. If you wish to cook utilizing the entire cooking surface, light the coals as instructed and then spread them across the entire fire box after the coals are glowing red.

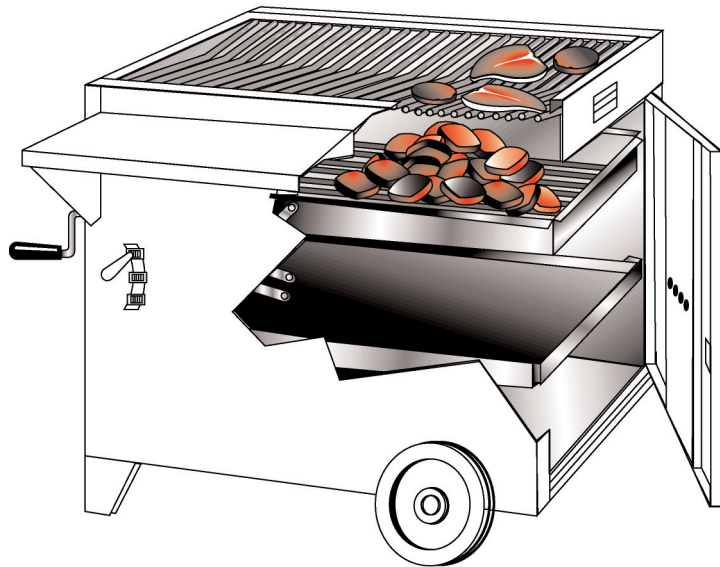

INDIRECT COOKING

Indirect cooking is done by cooking with heat only, instead of using direct fire. This method is used for smoking, roasting or baking. The fire box is usually in one of the lower positions ("bake" or "smoke" on the cooking style indicator), with the heat deflector in place over the coals. Food may be placed on either side of the grill while cooking with this method, or you can utilize the entire cooking surface. Recipe times are based on the fire box being positioned 8 to 14 inches below the cooking grills. Cooking times will decrease as the fire box is raised. Your fire will need to be refueled when using indirect cooking, so remember to check your fire about 1½ to 2 hours throughout the cooking process.

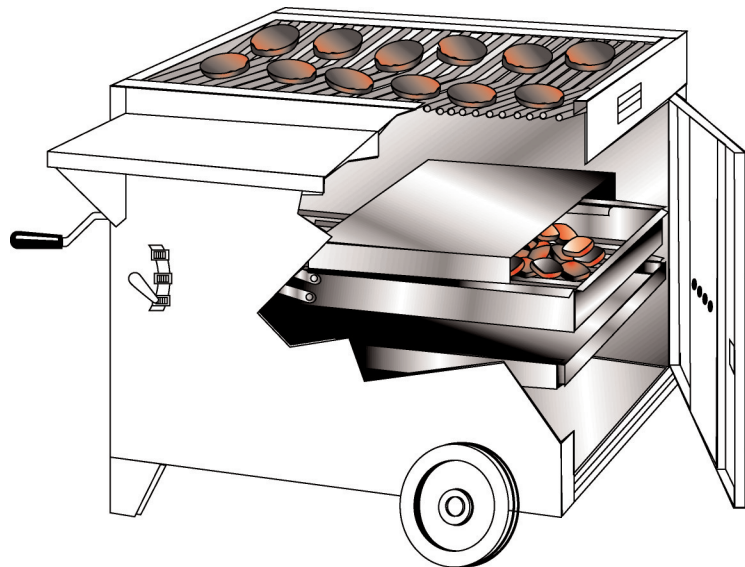

COMBINATION COOKING

Combination cooking is done by cooking some foods directly over the coals while cooking other foods on the opposite end of the fire. The fire box should be in the highest position ("sear" on the cooking style indicator), or 4 to 6 inches below the cooking grills, with the heat deflector removed. With the fire confined to one end of the fire box, you may cook potatoes, corn, bread, chicken parts, etc., at the end away from the fire while searing steaks, chops, etc., directly over the coals at the same time. Remember that the hood must be closed for combination cooking, and slower cooking foods should be started earlier than the "searing" foods.

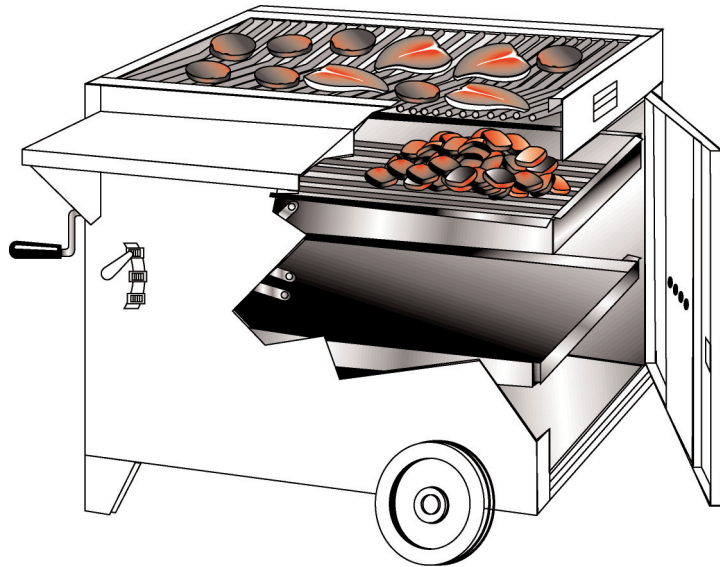

ROTISSERIE COOKING

Rotisserie cooking is impressive and fun. However, you can easily and successfully cook anything on a Hasty-Bake without using a rotisserie since our unique design allows the heat and smoke to rotate around your food. However, should you desire to use the rotisserie cooking method, we do have rotisserie kits available for all Hasty-Bake models (except the Portable).

Rotisserie cooking involves having the food rotate constantly throughout the cooking process. Always balance your meat well on the spit rod and secure it with the spit forks.

It is a good idea to double check to make sure that the meat is secure. Tie or pin fowl wings flat against the sides of the bird. Rotisserie cooking times may be faster than those used for roasting or baking by the indirect cooking method. To keep fat and juices from falling directly into the fire, spread the coals along the outer edges of the fire box and place aluminum foil beneath the meat to catch the drippings. The heat will rise along the back of the unit, cooking the meat on all sides as it rotates. Another option is to confine the coals to one side of the fire box with the heat deflector in place. This is a form of indirect cooking, using the spit rod for self-basting. Foods which are rotated while cooking tend to be self-basting, and therefore more moist and juicy.

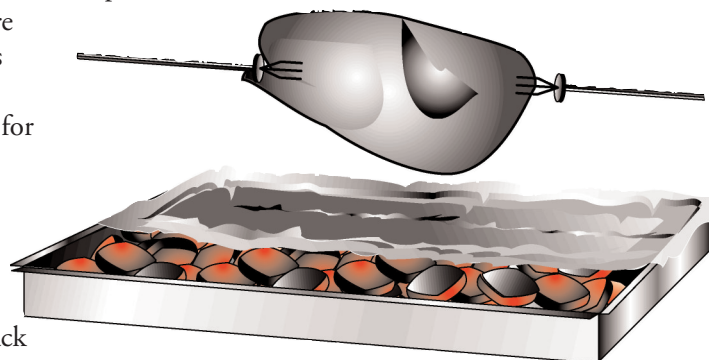

Getting Started

1

Open the hood and dual draft vents.



2

Excess grease build up should be removed from the top of the heat deflector and the grease drain to prevent grease fires.



3

Open the fire door. Slide the ash pan and fire box approximately half way out. Load the charcoal (we recommend hardwood charcoal) into the fire box. The charcoal should be loaded in the right side of the fire box only, level with the top of the fire box. If you are planning to sear over the entire cooking surface, still load the charcoal in the right side only and spread it evenly across the fire box after the charcoal has reached desired intensity.



4

Slide the fire box back into the unit. Place two Firelighters on the ash pan and slide the ash pan back into the unit. Using the crank handle, lower the fire box until it is positioned approximately 1 inch above the ash pan. This will allow the flames from the Firelighters to leap up through the charcoal until the charcoal is well ignited. If using hardwood charcoal, the fire should be fully ignited in 10 to 15 minutes.

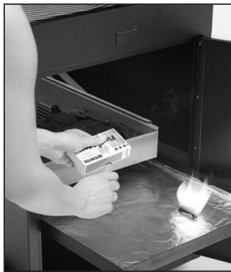

Should you prefer something other than Firelighters to start your grill, we suggest using Firestarter. Hasty-Bake does not recommend using any type of petroleum-based lighter fluids – they only ruin the taste of your foods!

5

Once the thermometer indicates a temperature between 150 and 200°F, excess grease build up on the cooking grills should be removed (we recommend using a grill brush) to clean the grills and help prevent grease fires.



NOTE: If a grease fire ever occurs, you should immediately close the hood, dual draft vents and fire door (if it is open), to quickly suffocate the fire.

Hardwood Charcoal

Hasty-Bake Hardwood Charcoal is 100% charred hardwood made primarily from oak and hickory. Easy to light, this key ingredient for Hasty-Bake cooking does not contain any fillers or chemical additives. Hardwood charcoal burns hotter and gives food great campfire flavor, and it will have you cooking in 10 to 15 minutes without the use of lighter fluid.

Firelighters

Firelighters are oversized kitchen matches made of fine wood particles coated with paraffin which burn completely in 6 to 8 minutes.

Firestarter

Firestarter is an odorless, alcohol-based fire starting gel, that helps achieve quicker ignition times.

Grill Brush

Our grill brush has an 18" wood handle, brass bristles and a stainless steel scraper tool.

Cooking Tips

CONTROLLING THE TEMPERATURE

There are basically three ways in which you can control the inside oven temperature of your Hasty-Bake. You must take into consideration that outside factors such as humidity, wind and temperature are beyond your control, but with continued use of your Hasty-Bake you will quickly become experienced in controlling the inside oven temperature by using the following methods:

AMOUNT OF CHARCOAL – The more charcoal you use, the higher the temperature.

POSITION OF THE FIRE BOX – Lower the fire box to lower the temperature (slowing down the cooking process) and raise the fire box to raise the temperature (speeding up the cooking process).

DUAL DRAFT VENTS – Charcoal requires oxygen to burn. Therefore, opening the draft vents will raise the temperature inside the oven and closing the draft vents will lower the temperature.

TEMPERATURE GUIDELINES

SMOKE

Smoking or slow cooking is done with the hood closed and the food placed over indirect heat (coals are covered with the heat deflector). Temperatures are usually kept in the 175 to 210°F range.

BAKE

Baking is done with the hood closed and the food placed over indirect heat (coals are covered with the heat deflector). Temperatures are usually in the 210 to 275°F range.

SEAR

Searing is done with the hood open and the food placed directly over the coals, (without the heat deflector in place) for greater heat intensity. The cooking surface will reach temperatures as high as 600°F. (Be aware that the temperature will not be measured by the thermometer since the hood is usually left open when searing.)

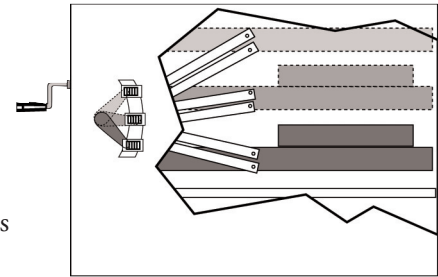

USE OF WOOD CHUNKS

You can enhance the flavor of any food with smoke by using either wood chips or chunks. Both do an excellent job of adding smoke. However, wood chunks are more often preferred since they are bigger and usually last longer than wood chips. To achieve an intensified flavor, we suggest soaking the wood chips or chunks in water for a least an hour before use.

Wood chips or chunks can be added to the cooking process by two different methods:

1. Place water-soaked wood chips or chunks in a small aluminum foil pan and place the pan directly on the coals or on top of the heat deflector. This creates a slow smoke release.
2. Place water-soaked wood chunks directly in the fire box, mixed in with the coals. This creates a quick burst of smoke flavor.

Following are some guidelines for choosing the “right” woods for the foods you prepare. Of course, we always recommend that you experiment to find a taste that you like. Remember, your Hasty-Bake oven holds in the smoke and greatly intensifies the flavor, so be careful to avoid over-seasoning.

Alder – Good for salmon, turkey and chicken.

Apple – Tangy and clean-flavored, good for chicken, pork and fish. The greener the wood, the sweeter the smoke flavor.

Cherry – Sweet and fruity, best with duck and other poultry.

Grapevine – Good for steaks and other meats, poultry and seafood.

Hickory – Rich and smoky, hickory is the “basic” barbecue wood. It is especially good with pork.

Maple – Mellow, mild and sweet, maple is good with poultry, seafood and pork.

Mesquite – Robust and smoky, mesquite is best with beef.

Pecan – Similar to hickory but milder, use with beef, poultry and pork.

Persimmon – Use with beef and pork, also a great choice for wild game.



Installing A Rotisserie

SUBURBAN AND LEGACY

When utilizing a rotisserie with a Suburban or Legacy model, please note that you will need to remove the cooking grills, which will eliminate your cooking surface. Therefore, you will not be able to cook additional food items while using the rotisserie.

- Remove cooking grills and grease drain rod.
- Remove grease cup holder and position it on the next lower hole.
- Mount grease cup holder and rotisserie bracket together.
- Gently slide motor into bracket.
- Assemble spit rod and forks.
- Slide squared end of spit rod into the flap above the fire door.
- Place pointed end of spit rod into the square slot on the motor.
- Plug motor into electrical outlet and turn motor on when you are ready to begin rotisserie cooking.

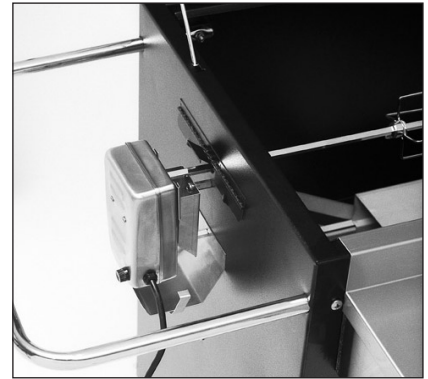

CONTINENTAL AND GOURMET

When utilizing a rotisserie on a Continental or Gourmet model, you have the ability to rotisserie cook without eliminating any cooking surface. However, you also have the option to use two rotisseries at once. Should you desire to operate two rotisseries at the same time, simply combine the installation instructions above with the installation instructions below.

- Remove warming grill (rack).
- Mount motor bracket in the two holes located on the left side of the grill hood.
- Gently slide motor into bracket.
- Assemble spit rod and forks.
- Slide squared end of spit rod into the flap above the fire door.
- Place pointed end of spit rod into the square slot on the motor.
- Plug motor into electrical outlet and turn motor on when are ready to begin rotisserie cooking.

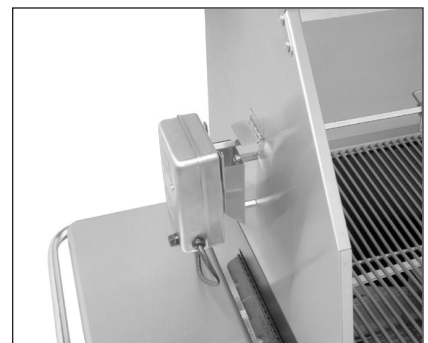

Troubleshooting & Common Questions

What should I do if a grease fire occurs?

Immediately close the hood, the dual draft vents and fire door (if it is open), to quickly suffocate the fire. Keeping your grease drain clean and cooking with the heat deflector in place will help reduce the chance of grease fires.

What should I do if my fire is beginning to die down?

Charcoal requires oxygen to burn. By opening the draft vents and fire door, you should be able to get your fire going again or you may simply need to add more charcoal to the fire box. However, if the fire has died down almost completely, and opening the vents and fire door does not reignite the fire, you will need to simply relight the charcoal.

How much charcoal should I use?

We recommend filling half of the fire box with hardwood charcoal. If you are planning to sear using the entire grill, you can spread the charcoal to the other side after it has reached the desired heat intensity.

What if I have charcoal left when I'm done cooking?

Simply close your grill (lid, fire door, draft vents) to smother the fire. You will be able to reuse the charcoal that is left in the fire box the next time you use your Hasty-Bake.

How do I regulate the heat in my Hasty-Bake?

There are basically three ways to control the temperature of your Hasty-Bake oven. Outside factors such as humidity, wind and temperature are beyond your control, but you will quickly become experienced in controlling the inside temperature by using these methods:

Amount of charcoal - The more charcoal you use, the higher the temperature.

Position of the fire box - Lower the fire box to lower the temperature and raise the fire box to raise the temperature.

Dual draft vents - Fire requires oxygen to burn. Open the draft vents (and even the fire door) to raise the temperature and close the grill to lower the temperature.

Good Ole Hasty-Bake Brisket

- 1 10 to 12 pound brisket
- ¾ cup soy sauce
- ¾ cup Worcestershire sauce
- ½ cup burgundy
- ¼ cup wine vinegar
- ¼ cup olive oil
- 3 Tablespoons lemon juice (fresh is best)
- 1 teaspoon garlic powder
- 1 teaspoon onion powder
- 1 teaspoon Hasty-Bake Gourmet Greek seasoning or equivalent

Mix all ingredients together for marinade. Pour over meat and marinate 24 hours in a glass or other nonreactive container or zip lock bag, turning several times. Remove meat from container and save marinade.

Over direct heat in your Hasty-Bake, sear the brisket on all sides. Lower the fire box and put the heat deflector in place over the coals to continue cooking with indirect heat. Place the brisket in a Hasty-Bake baster pan or aluminum foil basting pan. Pour reserved marinade over the brisket and cook until the internal temperature reaches 180°F (approximately 1 hour per pound at 200°F). (Optional: At this point, you may remove the brisket from the grill and slice into ¼" to ½" slices. Put the meat back into the pan with marinade.) Cover the pan and cook for 2 more hours. Drain marinade from meat and serve.

Grilled Lime-Marinated Sirloin Steak with Chipotle Honey Sauce

- 2½ pounds of sirloin steak

MARINADE

- 1 canned chipotle (or to taste)
- 2 cloves garlic, minced
- 1 Tablespoon chopped cilantro
- 4 Tablespoons vegetable oil
- 6 Tablespoons lime juice (about 5 limes)

SAUCE

- ½ cup honey
- 1½ cup peanut oil
- 2 or 3 canned chipotles
- 2 Tablespoons balsamic vinegar
- 4 Tablespoons brown mustard
- ¼ cup fresh lime juice
- 5 cloves garlic, minced
- 2 teaspoons ground cumin
- 4 Tablespoons chopped cilantro
- 2 teaspoons salt
- Freshly cracked black pepper to taste

Place steak in large dish, baking pan or zip-lock bag. Mix all marinade ingredients together and pour over steak. Cover and let marinate in the refrigerator for 4 to 6 hours, turning occasionally.

To make sauce:

Combine honey, peanut oil, chipotles, vinegar, mustard, lime juice, garlic, and cumin. Puree in a blender or food processor. Stir in the chopped cilantro and add salt and pepper to taste.

Salt and pepper steak to taste. Over very hot direct heat, grill the steak for 5 to 7 minutes on each side (for medium rare).

Remove the steak from the grill and let it rest for 3 to 5 minutes so that the juices drawn to the center by cooking redistribute for even color.

Serve the steak, which should be very juicy, either plain or on top of sliced French bread. Accompany each serving with several Tablespoons of sauce.

Ain't Momma's Meat Loaf (Smoke & Spice)

MEAT LOAF

- 1 Tablespoon oil, preferably canola or corn
- ½ cup minced onion
- ½ green or red bell pepper, chopped fine
- 3 garlic cloves, minced
- 1 teaspoon freshly ground black pepper
- 1 teaspoon salt
- ½ teaspoon cumin
- 1¼ pounds ground beef
- ¾ pound ground pork
- 1½ cups dry bread crumbs
- 3 Tablespoons sour cream
- 2 Tablespoons Worcestershire sauce
- 1 egg
- ¼ cup stock, preferably beef
- 1 teaspoon Tabasco or other hot pepper sauce to taste

BASIC BEER MOP (OPTIONAL)

- 12 ounces beer
- ½ cup cider vinegar
- ½ cup water
- ¼ cup oil, preferably canola or corn
- ½ medium onion
- 2 garlic cloves, minced
- 1 Tablespoon Worcestershire sauce
- 1 Tablespoon Wild Willy's Number One-derful Rub (see Chicken on a Throne recipe) or other savory seasoning blend

Prepare your Hasty-Bake to cook with indirect heat (with the heat deflector in place over the coals), bringing the temperature to 200 to 220°F.

In a heavy skillet, warm the oil over medium heat. Add the onion, bell pepper, garlic, pepper, salt and cumin and sauté until the vegetables are softened. Spoon the vegetable mixture into a large bowl.

Add the remaining meat loaf ingredients and mix well with your hands. Mound the meat into a smoke-proof loaf pan.

If you plan to baste the meat, stir the mop ingredients together in a small saucepan and warm over low heat.

Cook the loaf on your Hasty-Bake for 45 minutes, or until the meat has shrunk away from the sides of the pan. Gently ease the meat loaf out of the pan and place

directly onto the cooking grill of the Hasty-Bake. Continue cooking the meat until the internal temperature reaches 170°F (approximately 1½ hours), dabbing it every 30 minutes with the mop. When about 30 minutes of cooking time remain, apply a barbecue sauce of your choice to the top of the meat loaf.

After removing the loaf from the grill, allow it to sit at room temperature for 10 minutes before slicing and serve warm or refrigerate for later use in sandwiches.

Bill's Beef Power Rub (Paul Kirk's Championship Barbecue Sauces)

Use this rub on any beef cut. Sprinkle it on heavily and cook over indirect heat.

- 1 cup cane sugar
- 1 cup garlic salt
- ½ cup paprika
- 3 Tablespoons black pepper
- 2 Tablespoons chili powder
- 1 Tablespoon powdered beef base
- 1 teaspoon ground ginger
- 1 teaspoon onion powder
- 1 teaspoon ground coriander
- 1 teaspoon cayenne

Combine all of the ingredients in a sifter and sift to blend well. Store in an airtight jar in the refrigerator for 2 to 3 weeks or in the freezer for up to 6 months.

Hasty-Bake Signature Recipe Chicken

Chicken breasts, with or without skin and bones
16 ounce bottle of Italian salad dressing
Hasty-Bake Gourmet Greek or Lemon Pepper seasoning or equivalent
Soy sauce
Worcestershire sauce

Marinate chicken in Italian dressing for at least 1 hour and overnight if possible. (You may substitute equal parts olive oil and vinegar for Italian dressing, adding salt to taste.)

Cook chicken breasts bone side down at 225 to 250°F over indirect heat (the heat deflector should be in place over the coals). Baste every 20 minutes with a mixture of equal parts soy sauce and Worcestershire sauce using a spray bottle or brush. Sprinkle chicken with seasoning after last basting and again to taste before serving. Boneless breasts will be done in 30 to 40 minutes. Bone-in breasts will take 45 to 55 minutes to cook.

Chicken on a Throne (Smoke & Spice)

Two 3½ pound whole chickens

WILD WILLY'S NUMBER ONE-DERFUL RUB

6 Tablespoons paprika
2 Tablespoons ground black pepper
2 Tablespoons salt
2 Tablespoons sugar
1 Tablespoon chili powder
1 Tablespoon garlic powder
1 Tablespoon onion powder
1 teaspoon cayenne

INJECTION LIQUID

12 ounces beer
¼ cup oil, preferably canola or corn
¼ cup cider or white vinegar
2 teaspoons Wild Willy's Number One-derful Rub

THRONE MOP (OPTIONAL):

12 ounces beer
1 cup chicken stock
½ cup water
¼ cup oil, preferably canola or corn

1 Tablespoon Wild Willy's Number One-derful Rub
Two 12-ounce cans beer (no bottles please)
½ medium onion, chopped
¼ cup cider or white vinegar
4 garlic cloves, minced

The night before you plan to barbecue, combine the rub ingredients in a small bowl. In another bowl, combine the ingredients for the injection liquid. Remove the organs from the cavity of the chickens.

With a kitchen syringe, inject about ½ cup of the injection liquid deep into the breast and legs of each chicken in several spots. Massage the chickens thoroughly, inside and out, with the remaining injection liquid, working it as far as possible under the skin without tearing the skin. Cover the chickens well with the dry rub, again massaging inside and out and over and under the skin. Reserve at least 1 Tablespoon of the rub if you are planning to baste the chickens. Place the chickens in a plastic bag and refrigerate them.

Prepare your Hasty-Bake to cook with indirect heat (with the heat deflector in place over the coals), bringing the temperature to 200 to 220°F.

Remove the chickens from the refrigerator and let them sit at room temperature for about 30 minutes. While you wait, open the 2 beer cans and drink half—and only half—of each beer. With a can opener, remove the tops of the half-empty beer cans. Place half of the onion, vinegar, garlic and reserved rub in each can. Insert the replenished beer cans into the cavities of the chickens, balancing the birds so that they rest upright with their legs bent forward. The cans should sit flat on the grill or on a cooking tray, holding the chickens at attention while their insides are steaming and their outsides are smoking.

If you are going to use the mop, combine the ingredients in a saucepan and keep the mixture warm over low heat.

Transfer the chickens to the Hasty-Bake. Cook for approximately 2 to 3 hours, mopping every 30 minutes or so. When the chickens are done, the legs will move freely and the internal temperature should be 165°F.

Let the chickens sit for 5 to 10 minutes. Remove the skins, carve the chickens, and serve.

Quick Chick (Smoke & Spice)

6 boneless, skinless, individual chicken breasts,
pounded lightly

SPLIT-SECOND DRY RUB

1 Tablespoon paprika
1 teaspoon salt
1 teaspoon sugar
½ teaspoon freshly ground black pepper
½ teaspoon onion powder
Pinch cayenne

SPLIT-SECOND MOP

1 cup orange juice
3 Tablespoons butter
1 Tablespoon Worcestershire sauce

Prepare your Hasty-Bake to cook with indirect heat (with the heat deflector in place over the coals), bringing the temperature to 225 to 250°F.

Combine the rub ingredients in a small bowl. Rub the breasts with the mixture and let them sit at room temperature for about 20 minutes.

Combine the mop ingredients in a small saucepan, placing the pan over low heat to melt the butter. Keep the mop warm over low heat.

Drizzle the breasts with about ½ of the mop. Transfer the chicken to the Hasty-Bake and cook for 30 to 40 minutes, or until cooked through. Either mop the breasts half-way through the cooking time, or drizzle with mop as soon as you remove them from the grill.

Hasty-Bake Smoked Turkey (It's not just for the holidays)

4 quartered onions
1 10 to 12 pound turkey (if you need more turkey, it is best to smoke two small birds)
Hasty-Bake Gourmet Greek seasoning or poultry rub
6 to 8 cloves peeled garlic
Basting liquid of your choice: white wine, chicken stock, flat champagne, apple juice, beer

Clean all internal parts from the turkey. Rub the seasoning over the entire turkey, getting on and under the skin and in the cavity. Stuff the cavity with the onions and cloves of garlic.

Put the turkey in a large aluminum baking pan or Hasty-Bake baster pan. Fill the pan with ¼" to ½" of the basting liquid of your choice. Make sure the heat deflector is in place over the coals and bring your Hasty-Bake to about 200°F. Cover the breast of the turkey with a flourcloth or cheesecloth soaked in olive oil, butter or bacon grease. Baste the bird about every 30 minutes – it is important that you don't let the turkey dry out.

Smoke the turkey approximately ½ hour per pound, plus one additional half hour. You will need to refresh the supply of hardwood charcoal about every 1 to 1½ hours. Small amounts of fruit wood, such as apple or cherry, may be added to the fire to give your turkey a stronger smoke flavor. To test for doneness, use an Insta-Read thermometer. The thickest part of the breast should be 165°F.

Note: To have a picture-perfect bird, you should remove the flourcloth or cheesecloth to brown the breast about 30 minutes prior to removing the turkey from the grill.

Jerked Pork Tenderloin with Orange-Red Onion Salsa

2 pork tenderloins, 10 to 12 ounces each

MARINADE

4 green onions, chopped fine
4 cloves garlic, minced
2 serrano chiles, chopped fine
1 teaspoon salt
2 Tablespoons jerk seasoning
2 teaspoon cider vinegar
¼ cup vegetable oil

To make marinade:

Combine all ingredients and mix well.

SALSA

1 orange, peeled, seeds removed, divided into sections and cut into smaller pieces
1 red onion, diced small
1 teaspoon minced garlic
5 Tablespoons lime juice (about 3 limes)
1 teaspoon minced free red or green chile pepper of your choice
1 teaspoon ground cumin
2 Tablespoons chopped fresh cilantro
1 teaspoon chili powder
Salt and freshly cracked black pepper to taste

To make salsa:

Combine all the salsa ingredients, mix well and set aside. (This mixture will keep, covered and refrigerated, for 3 or 4 days.)

Place whole pork tenderloins in zip-lock bag with marinade and massage well. Refrigerate for 2 to 4 hours.

With the heat deflector in place over the coals, bring the temperature of your Hasty-Bake to 225 to 250°F. Cook the tenderloins until the internal temperature reaches 160°F (approximately 1 hour). Remove and let rest for 10 minutes before serving. To serve, slice into ¼" medallions and top with salsa.

Lone Star Spareribs (Smoke & Spice)

3 full slabs of pork spareribs, St. Louis cut (trimmed of the chine bone and brisket flap), preferably 3 pounds each or less

BARBECUED RIB RUB

½ cup ground black pepper
¼ cup paprika
2 Tablespoons sugar
1 Tablespoon salt
1 Tablespoon chili powder
1½ teaspoons garlic powder
1½ teaspoons onion powder

BASIC BEER MOP (OPTIONAL)

12 ounces beer
½ cup cider vinegar
½ cup water
¼ cup oil, preferably canola or corn
½ medium onion
2 garlic cloves, minced
1 Tablespoon Worcestershire sauce
1 Tablespoon Barbecued Rib Rub

The night before you plan to barbecue, combine the rub ingredients in a small bowl. Apply the rub evenly to the ribs, reserving about half the spice mixture. Place the slabs in a plastic bag and refrigerate overnight.

Remove ribs from the refrigerator. Pat them down with remaining rub, reserving 1 Tablespoon if you plan to use the mop. Let the ribs sit at room temperature for 30 to 40 minutes. Prepare your Hasty-Bake to cook with indirect heat (with the heat deflector in place over the coals), bringing the temperature to 200 to 220°F.

If you are going to baste the ribs, mix together the ingredients in a saucepan and warm over low heat.

Cook the ribs on your Hasty-Bake for 3 to 5 hours, turning and basting them with the mop about once an hour. When ready, the meat should be well-done and pulling away from the bones. Allow to sit for 10 minutes before slicing into individual ribs.

The Renowned Mr. Brown (Smoke & Spice)

6 to 8 pound Boston butt

SOUTHERN SUCCOR RUB

¼ cup ground black pepper
¼ cup paprika
¼ cup turbinado sugar
2 Tablespoons salt
2 teaspoons dry mustard
1 teaspoon cayenne

SOUTHERN SOP (OPTIONAL)

Remaining Southern Succor Rub
2 cups cider vinegar
1 cup water
3 Tablespoons ground black pepper
2 Tablespoons salt
1 Tablespoon Worcestershire sauce
1 Tablespoon paprika
1 Tablespoon cayenne

The night before you plan to barbecue combine the rub ingredients in a small bowl. Massage the pork well with about half of the rub. Transfer the pork to a plastic bag and refrigerate overnight.

Remove the pork from the refrigerator. Pat down with another coating of rub. Let the pork sit at room temperature for about 45 minutes.

Prepare your Hasty-Bake to cook with indirect heat (with the heat deflector in place over the coals) bringing the temperature to 200 to 220°F. If you plan to baste the pork, stir any remaining rub together with the mop ingredients in a saucepan and warm over low heat.

Cook the pork on your Hasty-Bake for about 1½ hours per pound, or until the internal temperature reaches 180°F. Mop the pork about once an hour.

Remove the pork from the grill and let it sit for about 15 minutes, until cool enough to handle. Pull off chunks of the meat, and either shred or chop them as you wish.

For a real Southern treat, top your pulled pork sandwich with slaw and vinegar sauce, squishing the bun together so that the meat juices and sauce mingle:

CAROLINA SANDWICH SLAW

2 cups chopped cabbage
2 Tablespoons minced onion
2 Tablespoons white vinegar
1½ Tablespoons mayonnaise
2 teaspoons sugar
¼ teaspoon salt
Generous grinding of black pepper

Mix all ingredients together in a bowl and refrigerate, covered, for at least 30 minutes before serving.

VAUNTED VINEGAR SAUCE

1 cup white vinegar
1 Tablespoon sugar
1 teaspoon salt
½ teaspoon freshly ground black pepper
½ teaspoon cayenne or hot red pepper flakes

Combine all the ingredients in a bowl and stir until the sugar dissolves.

Down-Home Barbecue Sauce (Paul Kirk's Championship Barbecue Sauces)

This sauce is great, warm or chilled, as a finishing or dipping sauce for pork of any kind (it's also good on chicken).

2 Tablespoons chili powder
2 Tablespoons black pepper
2 teaspoons ground cinnamon
1 teaspoon ground allspice
1 teaspoon salt
½ teaspoon cayenne
1 32-ounce bottle of ketchup
½ cup prepared yellow mustard
½ cup cider vinegar
1 cup brown sugar
2 Tablespoons Worcestershire sauce
2 Tablespoons soy sauce
1 Tablespoon liquid smoke

Combine the chili powder, black pepper, cinnamon, allspice, salt, and cayenne in a nonreactive saucepan. Blend in the ketchup, mustard, vinegar, brown sugar, Worcestershire sauce, soy sauce, and liquid smoke. Bring the mixture to a boil. Reduce the heat and simmer for about 30 minutes, stirring occasionally.

This sauce will keep for several weeks in an airtight jar in the refrigerator.

Jalapeno-Lime Shrimp (Smoke & Spice)

1 pound large shrimp, peeled and deveined

JALAPENO-LIME MARINADE

½ cup pickled jalapeno slices
¼ cup pickling liquid from jar or can of pickled jalapenos
Juice of 2 limes
4 Tablespoons corn oil, preferably unrefined
3 Tablespoons minced fresh cilantro
4 green onions, sliced
3 garlic cloves, minced

JALAPENO-LIME MOP

Remaining Jalapeno-Lime Marinade
½ cup seafood or chicken stock
Juice of 1 lime

Slices of fresh red jalapeno or other red chile, for garnish (optional).

Puree the marinade ingredients in a food processor or blender.

Place the shrimp in a shallow, nonreactive dish or plastic bag. Pour the marinade over the shrimp and let the shrimp marinate at room temperature for 30 to 40 minutes.

Prepare your Hasty-Bake for barbecuing, bringing the temperature to 180 to 200°F.

Drain the shrimp from the marinade, pouring the marinade into a saucepan. Add the stock and additional lime juice to the remaining marinade for the mop. Bring the liquid to a vigorous boil over high heat and boil for several minutes. Keep the mop warm over low heat.

Place the shrimp on a small grill rack and baste liberally with the mop. Transfer the shrimp to the smoker and place away from the fire (make sure to have your heat deflector in place over the coals). The shrimp should cook in approximately 25 minutes, but watch them carefully. They are ready when opaque, slightly firm, and lightly pink on the exterior. Remove the shrimp from the grill and mop them heavily again. Place the shrimp on a platter, scatter the red chiles over them, if you wish, and serve.

T-Shirt Fish

Go fishing and get lucky enough to pull out a few 10 ounce/1 pound trout, salmon or other fish, or just go buy some at a good fish store. Gut each fish and season with salt, pepper and lemon.

Prepare a hot bed of coals (in your Hasty-Bake).

Decide to part with an old t-shirt, but save the cleaned and bleached relic for its final sacrifice. Soak the shirt in salt water to remove any impurities. Rinse and machine dry.

Buy some dill or fennel grass, about ½ to 1½ pounds. Spread it out onto the t-shirt and top with the fish. Put a branch of celery, carrot and/or onion in the cavity for seasoning. Roll the fish up in the herbs and t-shirt and tie with a string. Brush the whole t-shirt with oil. Set it to smoke directly on the live coals. The t-shirt will catch fire. Close the lid of your grill and allow the package to smolder.

Flip the fish once after 4-5 minutes. Remove after 10 minutes with the assistance of 2 spatulas. Allow the fish to cool overnight.

The fish technically steams in the herb and cotton jacket, but gains the smoke from the fire. It handles best when cold.

Peel off the t-shirt and herb wrap and discard. Separate the skin from the flesh. Pick out the bones and fins.

Serve the fish with a light green salad with boiled potatoes, lemon dressing and olive oil.

Tasty Satay Tuna (Sublime Smoke)

4 tuna steaks, each approximately 1 inch thick
¼ teaspoon coarse salt

PASTE

¼ cup peanut oil
Juice and zest of 1 lemon
2 Tablespoons minced fresh cilantro
2 Tablespoons minced fresh mint
1 Tablespoon creamy peanut butter
1 Tablespoon soy sauce
1 Tablespoon minced fresh ginger
2 garlic cloves, minced
Lemon wedges for garnish (optional)

In a food processor, process the paste ingredients to a thick puree. Rub the paste over the tuna steaks. Wrap the tuna in plastic and let it sit at room temperature for 30 minutes.

Bring your Hasty-Bake to 225 to 250°F. Warm a skillet over high heat and sprinkle in the salt. Add the steaks and sear them quickly on both sides. Transfer the steaks to the Hasty-Bake. Cook them until medium rare (still a pink tint to its warmed through interior), about 15 minutes. Avoid overcooking the tuna. Serve hot, garnished with lemons if you wish.

Scallops in Balsamic Vinegar (Sublime Smoke)

MARINADE

½ cup inexpensive balsamic vinegar
1 Tablespoon extra-virgin olive oil
3 plump garlic cloves, minced

1½ pounds sea scallops
1 Tablespoon extra-virgin olive oil
2 Tablespoons minced fresh basil
Coarse salt to taste

Combine the marinade ingredients in a bowl. Place the scallops in a nonreactive dish or plastic bag and pour the marinade over them. Marinate the scallops at room temperature for 30 minutes.

Drain the marinade into a small saucepan. Arrange the scallops on a small grill rack, grill basket or piece of heavy-duty foil and transfer them to your Hasty-Bake. Smoke them until opaque and just barely cooked through, about 10 to 15 minutes at 225 to 250°F.

While the scallops cook, boil the marinade over high heat for several minutes, reducing it until syrupy.

Toss the scallops in a bowl with the oil. Add the basil and salt and toss again. Drizzle some of the reduced marinade into the scallops, 1 or 2 teaspoons at a time, until it just complements but doesn't mask the scallops' sweetness. Spoon the scallops on individual plates and serve.

Roasted Red Peppers

Cut each bell pepper in half and remove the core and seeds. Place the pepper over a medium-hot direct fire on the grill and roast, turning occasionally, until completely charred (about 10 minutes). Place the pepper in a paper bag and let it steam for about 10 minutes, until it's cool enough to handle. Peel away the skin and slice the pepper into strips.

Herb Butter-Basted Corn-on-the-Cob (The Vegetarian Grill)

- 6 ears corn, unhusked
- 1 fresh herb sprig (such as basil, cilantro, oregano, thyme, chives, etc.)
- 1 garlic clove
- ½ teaspoon salt
- 1½ Tablespoons unsalted butter

Prepare a medium-hot direct fire in your Hasty-Bake.

Peel back the husks from the corn and remove the silks. Place in water to soak for at least 10 minutes.

On a cutting board, or in a mortar, combine the herb, garlic and salt. Mince finely or pulverize. Add the butter to the mortar or combine in a bowl with the herb mixture, and work until you have a smooth paste. Lightly spread on the corn. Bring the husks back over the cobs.

Grill the corn, turning frequently, until the husks are dry and the kernels are beginning to brown, 15 to 20 minutes. Serve hot off the grill.

Soy-Grilled Green Beans (The Vegetarian Grill)

- 1 pound green beans, trimmed
- 2 Tablespoons toasted sesame oil
- 1 Tablespoon soy sauce
- 1 Tablespoon dry sherry or Chinese rice wine
- 2 garlic cloves, minced

Prepare a medium direct fire in your Hasty-Bake with a lightly oiled vegetable grill rack or grill wok in place.

Place the beans in a shallow dish. Add the sesame oil, soy sauce, sherry or rice wine and garlic. Toss to coat.

Lift the beans out of the marinade with a pair of tongs. Grill the beans, tossing frequently, until tender and browned, 8 to 10 minutes.

Place the beans in a serving dish. Pour over any remaining marinade. Serve hot.

Calico Pepper Salad (Smoke & Spice)

- 3 large bell peppers, preferably 1 each of red, yellow and green
- 1 small onion
- 1 fresh green chile, preferably New Mexican, Anaheim or poblano (optional)
- 1 fresh jalapeno or 1 to 2 fresh serranos
- 3 garlic cloves
- 1 Tablespoon oil, preferably canola or corn
- 1 Tablespoon garlic-flavored oil
- 1 Tablespoon minced fresh cilantro
- ½ teaspoon ground cumin
- Dashes of red wine vinegar
- Salt to taste

Prepare your Hasty-Bake to cook with indirect heat (with the heat deflector in place over the coals), bringing the temperature to 200 to 220°F.

Rub the bell peppers, onion, green chile, jalapeno, and garlic with enough canola or corn oil to coat their surfaces lightly.

Transfer the vegetables to the smoker. Cook until they are well softened, 25 to 30 minutes for the garlic and 65 to 75 minutes for everything else. Remove each of the vegetables as it is done.

Place the bell peppers, the green chile and the jalapeno in a plastic bag to steam. Chop the garlic and onion finely and transfer them to a bowl. Remove the peppers from the bag and pull the skin off of each. Slice the bell pepper and green chile into thin ribbons and add them to the garlic and onion. Mince the jalapeno and add about half of it to the bowl.

Stir in the garlic-flavored oil, cilantro, cumin and a bit of vinegar and salt to taste. Add more jalapeno or the other seasonings as desired. Serve warm or chilled.

Garlic Bread

Make diagonal slices into a loaf of French bread about 1½" apart, being careful not to cut all the way through the bottom.

Mash one clove of garlic (or use about ¼ teaspoon of garlic powder) and mix well with ½ cup of butter. Spread butter mixture on both sides of each slice. Wrap the whole loaf in foil and heat at 180 to 200°F in your Hasty-Bake with the heat deflector in place over the coals until the bread is heated through (about 20 minutes).

Hasty-Baked Pizza Dough

- 1 package dry active yeast
- ¼ cup tepid water
- 1 Tablespoon honey
- 4 cups unbleached flour
- 1 teaspoon salt
- 1 teaspoon dried oregano
- 1 teaspoon dried basil
- 2 teaspoons olive oil
- 1½ cup cold water

In the bottom of a food processor, mix tepid water, yeast and honey. Process for a couple seconds.

Add flour, salt, oregano, basil and oil to the bowl of the food processor and pulse to combine.

Add water to bowl and process until dough is formed. Stop the machine and feel the dough. If it is too moist, sprinkle a little flour over the dough and process a couple more turns. Let the dough rest in the food processor for 4 to 5 minutes.

Now start the processor again and let the dough rotate in the bowl 25 to 30 times. This completes machine kneading. Remove the dough from the bowl and place on a lightly floured surface. Let dough rest another 2 minutes.

Place dough in an oiled bowl and cover with plastic. Put in a warm place until dough has doubled in size (approximately 1 to 1½ hours).

Remove dough from bowl and knead in order to deflate and redistribute yeast. Divide for the number of pizzas you will be making.

Prepare a medium direct fire in your Hasty-Bake. Clean grill surface well with a brush. Roll out dough to the appropriate size. Fold dough in half and lay on the

grill, then unfold so the crust is directly over the coals. Close the lid and wait about 3 minutes. Lift lid to check. The dough should be puffing up. When it is lightly browned, remove and invert it so the browned side is up on a pizza peel or a sheet pan.

Now place the toppings of your choice (sauce, chicken, veggies, cheese, etc.) on the cooked side. Slide the pizza back onto the grill, this time not directly over the coals. Close the lid and cook for another 10 minutes or until nicely done.

(Note: The best way to arrange the charcoal to make pizza on your Hasty-Bake is to confine your fire to the right side of your grill. Put the dough on the right side to brown the first time. Then use the left side to finish cooking the pizza with toppings.)

Baked Apples

Core a large cooking apple (the firmer and tarter the better). Fill the whole with red cinnamon candies, raisins and a bit of butter. Dot the rest of the apple with butter.

Place the apple in the center of a sheet of foil. Bring the corners together and twist, leaving the foil rather loose around the apple.

Cook on your Hasty-Bake at about 200°F with the heat deflector in place over the coals until the apple is soft, about 30 minutes.

Foil-Wrapped Apple Brown Betty (The Vegetarian Grill)

- 4 apples, peeled and thinly sliced
- ½ cup crushed graham cracker crumbs
- ¼ cup brown sugar
- 4 Tablespoons butter, melted
- 1 teaspoon ground cinnamon

Prepare a low fire on the grill (over a hot fire, the apples will scorch and their flavor will be bitter). Combine the apples, crumbs, brown sugar, butter and cinnamon in a bowl and mix well. Divide the mixture between 2 large pieces of heavy-duty foil and seal the packets so no liquid or steam will escape. Grill the packets, turning once, until apples are soft, about 20 minutes. Open the packets very carefully and serve warm.

Honey-Nut Fruit Kabobs (The Vegetarian Grill)

- 1 pineapple
- 2 large bananas, peeled and sliced 1½ inches thick
- 2 oranges, peeled and sectioned
- 3 Tablespoons butter
- 2 Tablespoons honey
- 1 Tablespoon Grand Marnier, Cointreau or other orange-flavored liqueur
- 1 cup finely chopped nuts (such as almonds, walnuts or pecans)

Prepare a medium-low direct fire in your Hasty-Bake.

On a cutting board, cut off the crown and bottom of the pineapple so it can stand. Slice down the sides, removing the peel and eyes. Cut into quarters and remove the core. Slice each quarter into chunks 1½ inches thick.

Arrange pineapple, bananas, and oranges on skewers. Combine the butter and honey in a small pan or microwave-safe container and heat until butter is melted. Stir in the liqueur. Brush the mixture onto the fruit and sprinkle each kabob with nuts.

Grill, turning occasionally, until the nuts are golden brown (5 to 10 minutes). Serve warm.

Caramelized Bananas (The Vegetarian Grill)

- 2 Tablespoons butter, melted
- 2 Tablespoons brown sugar
- 4 bananas

Prepare a medium direct fire. Combine the butter and brown sugar in a shallow dish. Peel the bananas, slice in half lengthwise, then again crosswise. Add the bananas to the butter mixture and toss very gently to coat. Grill the bananas, turning once, until a crispy brown coating of caramelized sugar forms on the surface (about 5 minutes per side). Watch carefully; don't allow sugar to char. Remove from the grill and serve hot.

What is Hardwood Charcoal?

- 100% pure charred hardwood
- Chemical free
- Natural chunk form
- Good “old fashioned” campfire flavor
- Lights without charcoal lighter fluid
- Burns hotter

Hasty-Bake Hardwood Charcoal

10 lbs. bag
(5 bags minimum order)



How is hardwood charcoal different than charcoal briquettes?

Generally speaking, manufacturers grind small pieces of natural charcoal (not necessarily hardwood) to face powder consistency. Then they mix it with 60% fillers (i.e., sand, straw, etc.). It is bound together with a petroleum coating to hold its form. It takes so long to turn a gray ash color because you must first burn off the chemical coating. Using lighter fluid adds one more chemical to your cooking process.

How is natural charcoal made?

Hasty-Bake Hardwood Charcoal is 100% charred hardwood made primarily from oak and hickory. These low-resin hardwoods have long been recognized for their superior charcoal. They produce a very dense charcoal that burns cleanly and gives a high amount of energy for its weight.

The wood is stacked in large steel ovens where the temperature inside rises to approximately 900°F, which cooks the liquors out of the wood. The wood becomes carbonized – creating natural hardwood charcoal.



The Hasty-Bake Philosophy

For over 50 years we have been leaders in the barbecue industry. It is our belief that superior flavor and healthier meals are a result of using pure, chemical-free hardwood charcoal. Petroleum products have their place. But, given the choice, why taint the flavor of your food? We prefer to enjoy great campfire flavor as it was intended!

Hasty-Bake Hardwood Charcoal, used in conjunction with our Hasty-Bake Charcoal Ovens, is a winning combination! You can grill, bake or smoke a variety of foods to perfection including red meats, fish, vegetables, fruits, stews, and even breads. Imagination is the only limitation!

Accessories

Hasty-Bake Apron

Black apron with embroidered Hasty-Bake logo.



Hasty-Bake T-Shirt

White T-shirt silk-screened with Hasty-Bake logo and design. Please specify size L, XL, or XXL.



Hasty-Bake Baseball Cap

Khaki cap with black trim on bill and embroidered Hasty-Bake logo.



Firestarter

Odorless, alcohol-based firestarting gel. (24 oz. bottle)

Firelighters

Oversized matches that burn for 6 to 8 minutes. (8 matches per box)



Hasty-Bake Grill Cover

Black cover silk-screened with Hasty-Bake logo, made of Sunbrella™ material. Each cover is designed to fit your particular Hasty-Bake model.

- Portable Cover
- Suburban Cover
- Continental Cover
- Legacy Cover
- Gourmet Cover
- Fiesta Cover



Hasty-Bake Grill Brush

18" wood handle, brass bristles with stainless steel scraper tool.

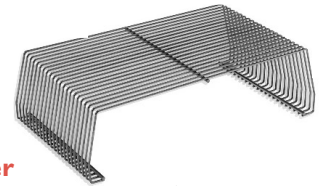

Hasty-Bake Grill Extender

Increase your cooking surface or use as a warming rack.

- Small (for Suburban and Continental)
- Large (for Legacy and Gourmet)



Hasty-Bake Baster Pan

Accessory used in place of a cooking grill for water, chili, beans and smoking meats.

- Small (for Suburban and Continental)
- Large (for Legacy and Gourmet)

Wok Topper/Grill Topper

Great porcelain coated grill accessories! Use when cooking foods that are small enough to fall through the grills. Wok topper has bowl-like sides to allow you to stir-cook vegetables, shrimp, etc. (you'll never use kabobs again). Flat grill topper has 1/2" edges on three sides – works best for cooking fish.

- 12" Wok Topper
- Stainless Steel 12" Wok Topper
- Grill Topper (16" x 12")



Poultry Roaster

Holds a chicken in the vertical position, searing the cavity to hold in the juices while draining fat.





Cookbooks

Hasty-Bake offers a selection of popular cookbooks by Cheryl Alters Jamison and Bill Jamison for all your grilling needs:

- Born to Grill* (a great book for high temperature grilling)
- Smoke & Spice* (one of the best books on cooking with smoke)
- Sublime Smoke* (another great resource for low temp cooking)

Lamson Sharp Utensil Sets

Simply the best barbecue utensils we have found! Stainless steel tools have rosewood handles. 4 piece set (includes spatula, basting brush, tongs and fork)



Hasty-Bake Rub and Seasonings

Selection of seasonings made from blends of herbs, spices and a few "secret" ingredients.

- Rub n' Spice - Won Best Rub on the Planet at 2002 American Royal
- Gourmet Greek
- Honey Lemon Pepper



Hasty-Bake Barbecue Sauce

A mild and sweet sauce with a traditional taste. (12 oz. bottle)



Dale's Marinade

Since 1946, gourmet chefs have been marinating their steaks, ribs, chicken and vegetables with this concentrated blend of herbs and spices. (10 oz. bottle)

Wood Chunks

Put extra flavor into your outdoor meals with our wood smoking chunks. Hickory and pecan are great with beef. Most fruit woods such as apple and cherry compliment poultry and pork. (Availability may vary.)



- | | | |
|--------|-------|-------|
| Apple | Pecan | Peach |
| Cherry | Pear | Alder |

Disposable Grease Cups

These little jewels need to be replaced every so often to keep your Hasty-Bake grease drainage system in proper condition. They can also be used for soaking wood smoking chips. (5 cups per package)



Rib Rack

These are the best rib racks money can buy! Ribs stand vertically, allowing fat to drain while the meat cooks evenly. Racks will hold country ribs, baby back ribs, even chicken quarters. Utilizes grilling space more efficiently.

- Small Rib Rack (4 slots)
- Large Rib Rack (8 slots)

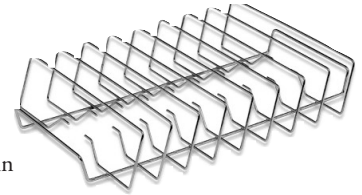

Hasty-Bake Front Storage Table

A stainless steel front work table with a storage compartment to hold utensils, matches, etc.

- Small (for Suburban and Continental)
- Large (for Legacy and Gourmet)



Hasty-Bake Rotisserie

A rotisserie is not really necessary on a Hasty-Bake due to its natural convection cooking effects. However, some people simply prefer cooking with a rotisserie. So we offer the finest motor, spit rod and forks that we can find (kit also includes mounting bracket).

- Small (for Suburban and Continental)
- Large (for Legacy and Gourmet)

HASTY-BAKE®

P.O. Box 471285 Tulsa, Oklahoma 74147

Phone: (918) 665-8220 or 1-800-4AN OVEN (1-800-426-6836)

Fax: (918) 665-8225

www.hastybake.com

Free Manuals Download Website

<http://myh66.com>

<http://usermanuals.us>

<http://www.somanuals.com>

<http://www.4manuals.cc>

<http://www.manual-lib.com>

<http://www.404manual.com>

<http://www.luxmanual.com>

<http://aubethermostatmanual.com>

Golf course search by state

<http://golfingnear.com>

Email search by domain

<http://emailbydomain.com>

Auto manuals search

<http://auto.somanuals.com>

TV manuals search

<http://tv.somanuals.com>