

HEALTHRIDER®

S O F T S T R I D E R

S200

Model No. 831.297970

Serial No. _____

Find the serial number in the location shown below. Write the serial number in the space above for reference.

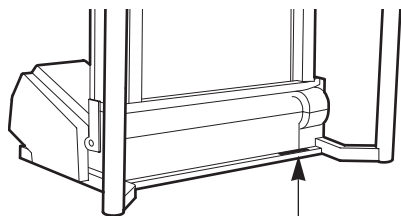

Serial Number Decal

EXERCISE
EQUIPMENT

QUESTIONS

HELPLINE!

1-800-736-6879



⚠ CAUTION

Read all precautions and instructions in this manual before using this equipment. Save this manual for future reference.

USER'S MANUAL

SEARS, ROEBUCK AND CO., HOFFMAN ESTATES, IL 60179

HEALTHRIDER®

S O F T S T R I D E R



TABLE OF CONTENTS

| | |
|--|------------|
| IMPORTANT PRECAUTIONS | .3 |
| BEFORE YOU BEGIN | .5 |
| SETTING UP THE TREADMILL | .6 |
| GROUNDING INSTRUCTIONS | .7 |
| CONSOLE OPERATION | .8 |
| HOW TO FOLD AND MOVE THE TREADMILL | .14 |
| TROUBLE-SHOOTING AND MAINTENANCE | .16 |
| CONDITIONING GUIDELINES | .18 |
| ORDERING REPLACEMENT PARTS | Back Cover |
| FULL 90-DAY WARRANTY | Back Cover |

Note: An EXPLODED DRAWING and a PART LIST are attached in the center of this manual. Please save them for future reference.

IMPORTANT PRECAUTIONS

⚠ WARNING: To reduce the risk of burns, fire, electric shock, or injury to persons, read the following important precautions and information before operating the treadmill.

1. It is the responsibility of the owner to ensure that all users of this treadmill are adequately informed of all warnings and precautions.
2. Use the treadmill only as described in this manual.
3. Place the treadmill on a level surface, with eight feet of clearance behind it. Do not place the treadmill on any surface that blocks air openings. To protect the floor or carpet from damage, place a mat under the treadmill.
4. Keep the treadmill indoors, away from moisture and dust. Do not put the treadmill in a garage or covered patio, or near water.
5. Do not operate the treadmill where aerosol products are used or oxygen is administered.
6. Keep children under the age of 12 and pets away from the treadmill at all times.
7. The treadmill should not be used by persons weighing more than 250 pounds. Never allow more than one person at a time on the treadmill.
8. Wear appropriate exercise clothing when using the treadmill. Do not wear loose clothing that could become caught in the treadmill. Athletic support clothes are recommended for both men and women.
9. Always wear athletic shoes when using the treadmill—never use the treadmill with bare feet, wearing only stockings, or in sandals. For maximum walking belt life, never use shoes with heavy treads.
10. When connecting the power cord (see page 9), plug the power cord into a surge suppressor (not included) and plug the surge suppressor into a grounded circuit capable of carrying 15 or more amps. No other appliance should be on the same circuit. Do not use an extension cord.
11. Use only a single-outlet surge suppressor that is UL 1449 listed as a transient voltage surge suppressor (TVSS). The surge suppressor must have a UL suppressed voltage rating of 400 volts or less and a minimum surge dissipation of 450 joules. The surge suppressor must be electrically rated for 120 volts AC and 15 amps.
12. Keep the power cord and the surge suppressor away from heated surfaces.
13. Never move the walking belt while the power is turned off. Do not operate the treadmill if the power cord or plug is damaged, or if the treadmill is not working properly. (See BEFORE YOU BEGIN on page 5 if the treadmill is not working properly.)
14. Never start the treadmill while you are standing on the walking belt.
15. Always hold the handrails when walking or running on the treadmill.
16. The treadmill is capable of high speeds; adjust the speed in small increments to avoid sudden jumps in speed.
17. Never leave the treadmill unattended while it is running. Always remove the key, unplug the power cord and move the on/off switch to the off position when the treadmill is not in use. (See the drawing on page 5 for the location of the on/off switch.)
18. Never drop or insert any object into any opening.
19. When operating the treadmill, keep hands and feet from underneath the treadmill.
20. You must be able to safely lift 45 pounds (20 kg) to raise, lower, or move the treadmill.
21. When folding or moving the treadmill, make sure that the storage latch is fully engaged.
22. Inspect and tighten all parts of the treadmill every three months.

23. **DANGER:** Always unplug the power cord immediately after use, before cleaning the treadmill, and before performing the maintenance and adjustment procedures described in this manual. Never remove the motor hood unless instructed to do so by an authorized service representative. Servicing

other than the procedures in this manual should be performed by an authorized service representative only.

24. The treadmill is intended for in-home use only. Do not use the treadmill in any commercial, rental, or institutional setting.

⚠ WARNING: Before beginning this or any exercise program, consult your physician. This is especially important for persons over the age of 35 or persons with pre-existing health problems. Read all instructions before using. SEARS assumes no responsibility for personal injury or property damage sustained by or through the use of this product.

SAVE THESE INSTRUCTIONS

The decals shown at the right and below have been placed on your treadmill. If a decal is missing, or if it is not legible, please call our toll-free HELPLINE to order a free replacement decal (see the back cover of this manual). Apply the decal in the location shown.

IMPORTANT:
Incline must be set at lowest level before folding treadmill into storage position.

⚠ WARNING

- Never allow children on or around treadmill.
- Storage latch must be fully engaged before treadmill is moved or stored.
- Incline must be set at lowest level before folding treadmill into storage position.

⚠ CAUTION

KEEP HANDS AND FEET AWAY FROM THIS AREA WHILE THE TREADMILL IS IN OPERATION.

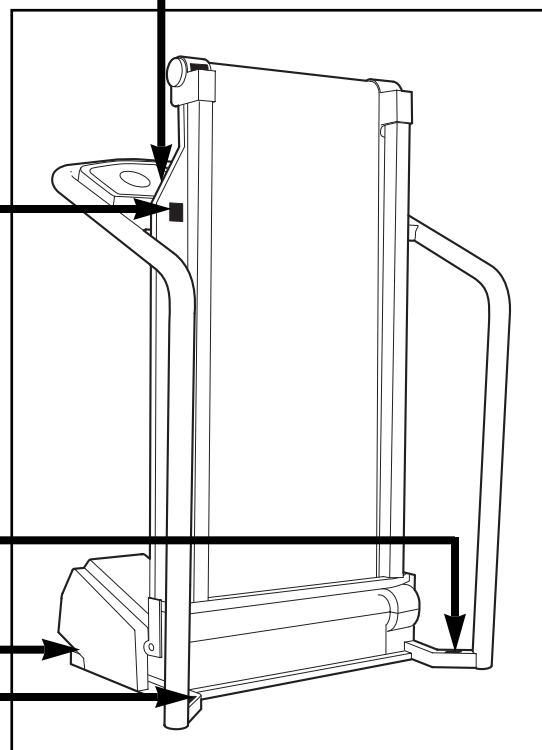

BEFORE YOU BEGIN

Congratulations for purchasing the SOFTSTRIDER S200™ treadmill by HealthRider. The SOFTSTRIDER S200 offers an impressive array of features that will help you to achieve your fitness goals in the convenience of your home. From the advanced console to the ultra-soft walking belt, the SOFTSTRIDER S200 is designed to make each workout more effective and enjoyable. And when you're not exercising, the SOFTSTRIDER S200 can be folded away, taking less than half the space of conventional treadmills.

For your benefit, read this manual carefully before using the SOFTSTRIDER S200 treadmill. If you have

additional questions, please call our toll-free HELPLINE at 1-800-736-6879, Monday through Saturday, 7 a.m. until 7 p.m. Central Time (excluding holidays). To help us assist you, please note the product model number and serial number before calling. The model number of the treadmill is 831.297970. The serial number can be found on a decal attached to the treadmill (see the front cover of this manual for the location).

Before reading further, please familiarize yourself with the parts that are labeled in the drawing below.

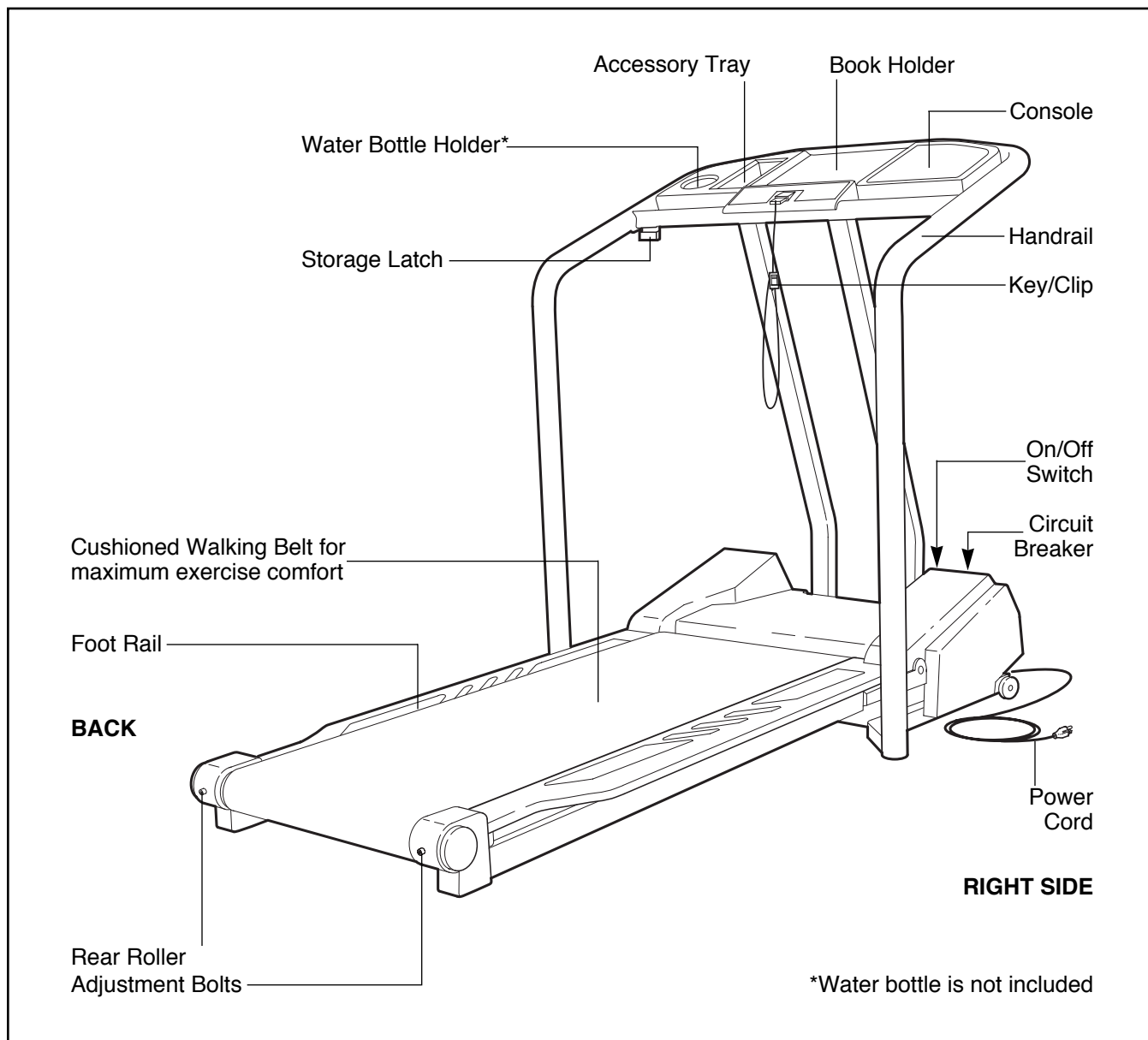

SETTING UP THE TREADMILL

Set-up requires two people. Place the treadmill in a cleared area and remove all packing materials. Do not dispose of the packing materials until the treadmill is set up. No tools are required.

Note: The underside of the treadmill walking belt is coated with high-performance lubricant. During shipping, a small amount of lubricant may be transferred to the top of the walking belt or the shipping carton. This is a normal condition and does not affect treadmill performance. If there is lubricant on top of the walking belt, simply wipe off the lubricant with a soft cloth and a mild, non-abrasive cleaner.

1. **With the help of a second person,** carefully raise the Uprights (82) until the Front Wheels (77) are resting on the floor as shown.

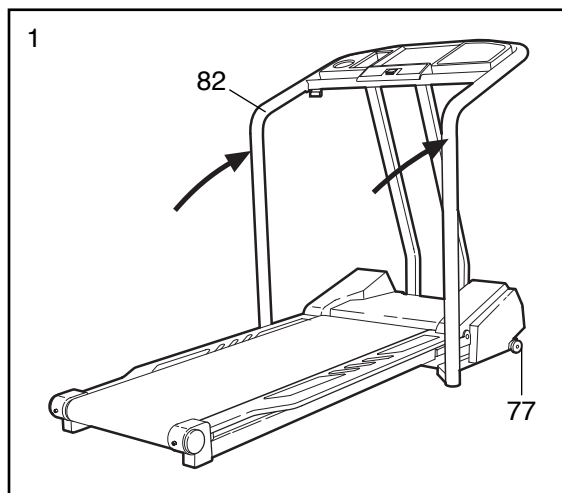

2. Remove the paper backing from the Wrench Clip (71). Press the Wrench Clip onto the Frame (92) in the indicated location. Press the Allen Wrench (72) into the Wrench Clip. Note: The use of the Allen Wrench is described on pages 16 and 17.

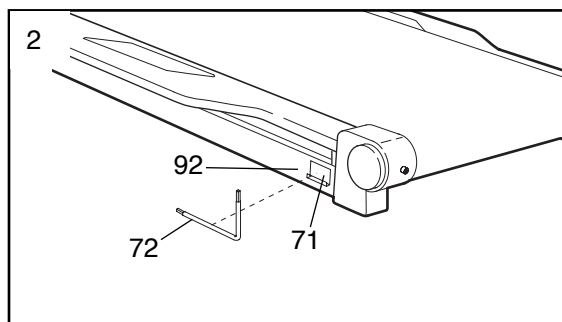

3. **Make sure that all parts are tightened before you use the treadmill. Place a mat beneath the treadmill to protect the floor or carpet.** For your benefit, we recommend that you familiarize yourself with the "TROUBLE-SHOOTING AND MAINTENANCE" section on pages 16 and 17 before using the treadmill.

OPERATION AND ADJUSTMENT

THE PERFORMANT LUBE™ WALKING BELT

Your treadmill features a walking belt coated with PERFORMANT LUBE™, a high-performance lubricant. **IMPORTANT: Never apply silicone spray or other substances to the walking belt or the walking platform. Such substances will deteriorate the walking belt and cause excessive wear.**

HOW TO PLUG IN THE POWER CORD

⚠ DANGER: Improper connection of the equipment-grounding conductor can result in an increased risk of electric shock. Check with a qualified electrician or serviceman if you are in doubt as to whether the product is properly grounded. Do not modify the plug provided with the product—if it will not fit the outlet, have a proper outlet installed by a qualified electrician.

Your treadmill, like any other type of sophisticated electronic equipment, can be seriously damaged by sudden voltage changes in your home's power. Voltage surges, spikes, and noise interference can result from weather conditions or from other appliances being turned on or off. **To decrease the possibility of your treadmill being damaged, always use a surge suppressor with your treadmill (see drawing 1 at the right).**

Surge suppressors are sold at most hardware stores and department stores. Use only a single-outlet surge suppressor that is UL 1449 listed as a transient voltage surge suppressor (TVSS). The surge suppressor must have a UL suppressed voltage rating of 400 volts or less and a minimum surge dissipation of 450 joules. The surge suppressor must be electrically rated for 120 volts AC and 15 amps.

This product must be grounded. If it should malfunction or break down, grounding provides a path of least resistance for electric current to reduce the risk of electric shock. This product is equipped with a cord having an equipment-grounding conductor and a grounding plug. **Plug the power cord into a surge suppressor, and plug the surge suppressor into an appropriate outlet that is properly installed and grounded in accordance with all local codes and ordinances.**

This product is for use on a nominal 120-volt circuit, and has a grounding plug that looks like the plug illustrated in drawing 1 below. A temporary adapter that looks like the adapter illustrated in drawing 2 may be used to connect the surge suppressor to a 2-pole receptacle as shown in drawing 2 if a properly grounded outlet is not available.

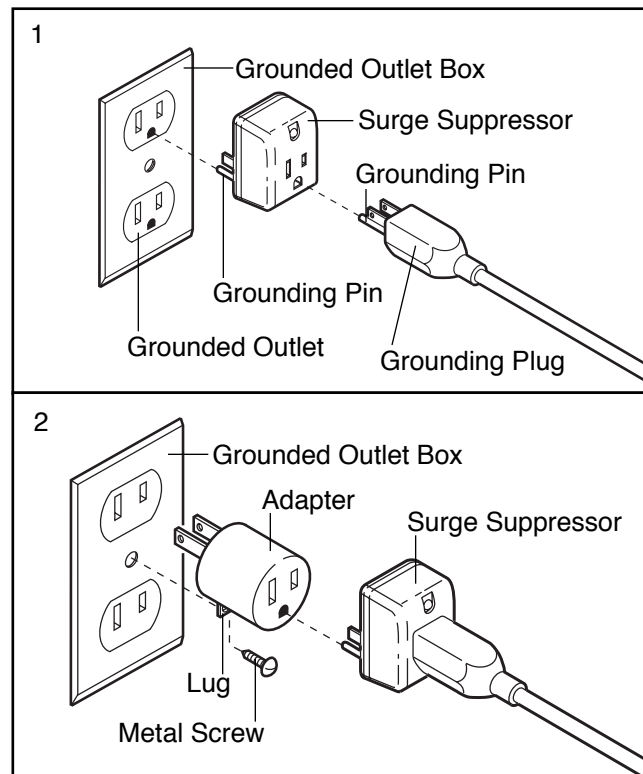

The temporary adapter should be used only until a properly grounded outlet (drawing 1) can be installed by a qualified electrician.

The green-colored rigid ear, lug, or the like extending from the adapter must be connected to a permanent ground such as a properly grounded outlet box cover. Whenever the adapter is used it must be held in place by a metal screw. **Some 2-pole receptacle outlet box covers are not grounded. Contact a qualified electrician to determine if the outlet box cover is grounded before using an adapter.**

CONSOLE OPERATION

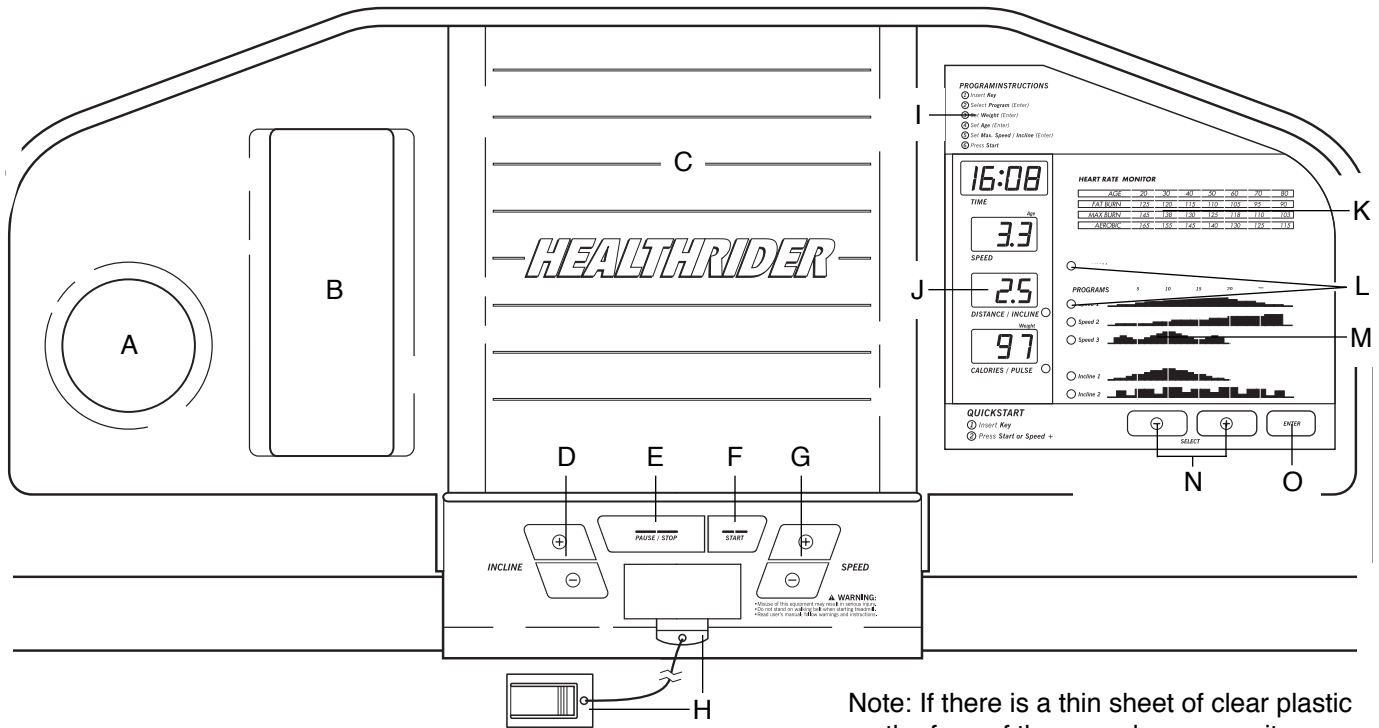

Note: If there is a thin sheet of clear plastic on the face of the console, remove it.

CAUTION: Before operating the console, read the following precautions.

- Do not stand on the walking belt when turning on the power or starting the walking belt.
- Always wear the clip (see H above) while operating the treadmill. If the key is pulled from the console, the walking belt will stop.
- The treadmill is capable of high speeds; adjust the speed in small increments.
- To reduce the risk of electric shock, keep the console dry. Avoid spilling liquid on the console and use only a sealable water bottle.

FEATURES OF THE CONSOLE

The advanced console offers a selection of features designed to make your workouts more enjoyable and effective. When the console is in the manual mode, the speed and incline of the treadmill can be changed with a touch of a button. As you exercise, the LED displays will provide continuous exercise feedback. The console also offers five preset workout programs. Three programs automatically control the speed of the treadmill and two programs automatically control the incline of the treadmill as they guide you through effective workouts.

An optional pulse sensor adds even more features to the console. The pulse sensor mounts in front of the console, allowing you to measure your heart rate at any time as you exercise. **To purchase the optional pulse sensor, refer to page 13.**

Note: The console can display speed and distance in either miles or kilometers (see page 11). For convenience, all instructions in this section refer to miles.

DIAGRAM OF THE CONSOLE

Refer to the drawing at the top of page 8.

- A. Water Bottle Holder—Keeps your water bottle handy during your workouts.
- B. Accessory Tray—Holds your personal items.
- C. Reading Rack—Allows you to enjoy your favorite magazine or read a book while you get in shape.
- D. INCLINE Buttons—These buttons control the incline of the treadmill. Each time a button is pressed, the incline will change by 0.5%. The incline range is 3% to 10%.
- E. PAUSE/STOP Button—This button stops the walking belt. When the button is pressed, the TIME, DISTANCE/INCLINE and CALORIES/PULSE displays will pause. If the button is held down for two seconds, the displays will be reset.
- F. START Button—This button starts the walking belt.
- G. SPEED Buttons—These buttons control the speed of the walking belt. Each time a button is pressed, the speed will change by 0.1 mph. The speed range is 0.5 mph to 10 mph.
- H. Key with Clip—The key turns the console on and off. The attached clip is designed to be worn on your waistband. If the key is pulled from the console, the power will automatically turn off.
- I. Operating Instructions—These instructions list the basic steps of console operation.
- J. LED Displays—These displays provide continuous feedback of the elapsed time, speed, distance, incline and the number of calories you have burned. The lower display also shows your heart rate when an optional pulse sensor is used.
- K. Heart Rate Table—This table lists recommended heart rates for fat burning and aerobic exercise (see **CONDITIONING GUIDELINES** on page 18).
- L. MANUAL/Program Indicators—These indicators show when the manual mode is selected and when one of the workout programs is selected.

M. Program Profiles—These profiles show how the speed or incline of the treadmill will change during workout programs. During the Speed 1 program, for example, the speed will gradually increase during the first half of the program, and then gradually decrease during the last half.

N. SELECT Buttons—These buttons are used to select the manual mode and the workout programs.

O. ENTER Button—This button is used to enter selections.

HOW TO TURN ON THE POWER

Make sure that the on/off switch, located on the front of the treadmill, is in the on position.

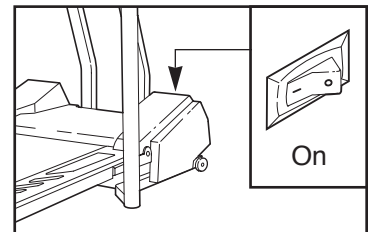

Next, make sure that the power cord is properly plugged in (see page 7). Note: If the key is in the console when the power cord is plugged in, the letters “PO” will flash in the CALORIES/PULSE display. If this occurs, remove the key.

Step onto the foot rails of the treadmill. Find the clip attached to the key, and slide the clip onto the waistband of your clothing. Next, insert the key fully into the console.

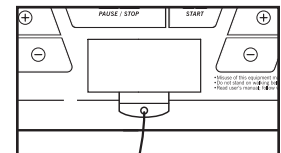

The MANUAL indicator will begin to flash; all other indicators and displays will remain dark.

HOW TO USE THE MANUAL MODE

1 Insert the key into the console.

See HOW TO TURN ON THE POWER on page 9.

Note: When you are familiar with the console, you may go directly to step 5. While learning to use the console, please read all steps.

2 Select the MANUAL mode.

When the key is inserted, the MANUAL indicator will begin to flash. (Note: If a program has been selected, hold down the PAUSE/STOP button for two seconds until the MANUAL indicator is flashing.) To select the manual mode, press the ENTER button while the MANUAL indicator is flashing.

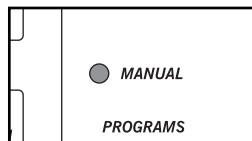

3 Enter your weight if desired.

When the manual mode is selected, the TIME display will light and a weight setting will begin to flash in the CALORIES/PULSE display. If you enter your weight into the console, the CALORIES/PULSE display will be more accurate.



If you do not want to enter your weight, press the ENTER button. To enter your weight, press the SELECT buttons. Each time a button is pressed, the weight setting will change by 1 pound. If a button is held down, the weight setting will change in increments of 5 pounds. When the correct weight is shown, press the ENTER button. Once your weight is entered, it will be saved in memory.

4 Enter your age if desired.

After a weight setting is entered, an age setting will begin to flash in the SPEED display.

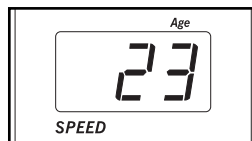

If you do not want to enter your age, press the ENTER button. If you want to enter your age, press the SELECT buttons. Each time a button is pressed, the age setting will change by 1 year. If a button is held down, the age setting will change in increments of 5 years. When the correct age is shown, press the ENTER button. Once your age is entered, it will be saved in memory.

5 Press the START button or the SPEED + button.

A moment after the button is pressed, the walking belt will begin to move at 1.0 mph. Hold the handrails and begin walking. As you exercise, change the speed of the walking belt as desired with the SPEED buttons. Each time a button is pressed, the speed will change by 0.1 mph. The speed range of the walking belt is 0.5 mph to 10.0 mph.

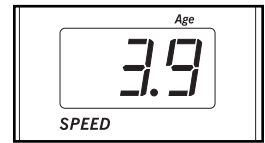

To stop the walking belt for a moment, press the PAUSE/STOP button. The displays will pause and the TIME display will begin to flash. To restart the walking belt, press the START button or the SPEED + button. Note: To stop the walking belt and reset all displays, hold down the PAUSE/STOP button for two seconds. The console will then be in the same state as if the key had just been inserted.

Note: When one of the SPEED buttons is pressed, the SPEED display will show the selected speed setting for seven seconds. The display will then show the actual speed of the walking belt.

6 Adjust the incline as desired.

To vary the intensity of your exercise, the incline of the treadmill can be changed with the INCLINE buttons. Each time a button is pressed, the incline will change by 0.5%. The incline range is 3% to 10%. Note: When one of the INCLINE buttons is pressed, the DISTANCE/INCLINE display will show the incline setting for seven seconds. After the INCLINE buttons are pressed, it may take a moment for the treadmill to reach the selected incline setting.

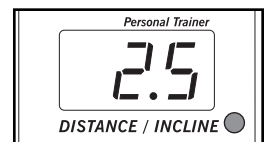

7 Follow your progress with the LED displays.

TIME display—This display shows the total time that the walking belt has been moving. Note: When a workout program is selected, this display will show the time remaining in the program.



SPEED display— This display shows the speed of the walking belt, in miles per hour or kilometers per hour.

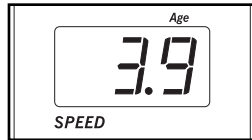

How to select miles per hour and kilometers per hour:

Hold down the PAUSE/STOP button while inserting the key into the console. An “E” (for english miles) or an “M” (for metric kilometers) will appear in the SPEED display. Press the SPEED + button to change the unit of measurement. Remove and then reinsert the key.

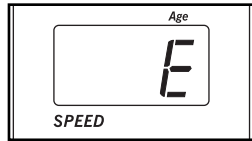

DISTANCE/INCLINE display—

This display shows the distance that the walking belt has moved and the incline level of the treadmill.

Every seven seconds, the display will change from one number to the other. The INCLINE indicator will light when the incline is shown. Note: If the speed is shown in mph, the distance will be shown in miles; if the speed is shown in kph, the distance will be shown in kilometers.

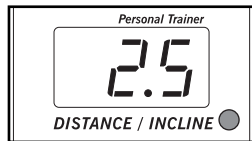

CALORIES/PULSE display—

This display shows the number of calories you have burned.

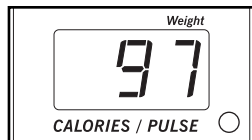

Note: If an optional pulse sensor is used, the CALORIES/PULSE display will show both the number of calories you have burned and your heart rate. Every seven seconds, the display will change from one number to the other. The PULSE indicator will light when your heart rate is shown.

8 When you are finished exercising, stop the walking belt and remove the key.

Step onto the foot rails and press the PAUSE/STOP button. Next, change the incline of the treadmill to 3%. **The incline must be at 3% when the treadmill is folded to the storage position or the treadmill will be damaged.** Remove the key from the console and put it in a secure place. Move the on/off switch to the off position (see page 9).

HOW TO USE THE SPEED PROGRAMS AND THE INCLINE PROGRAMS

The Speed 1, Speed 2 and Speed 3 programs automatically control the speed of the treadmill as they guide you through effective workouts; the Incline 1 and Incline 2 programs automatically control the incline of the treadmill.

Follow the steps below to use a Speed program or an Incline program.

1 Insert the key fully into the console.

See HOW TO TURN ON THE POWER on page 9.

2 Select the desired program.

To select a program, the **MANUAL indicator or a program indicator must be flashing.** If necessary, hold down the PAUSE/STOP button for two seconds until the MANUAL indicator is flashing. Next, **press the SELECT + or – button** repeatedly until the Speed 1, Speed 2, Speed 3, Incline 1 or Incline 2 program indicator is flashing. Then, press the ENTER button. A profile of the program you have selected will appear in the program display.

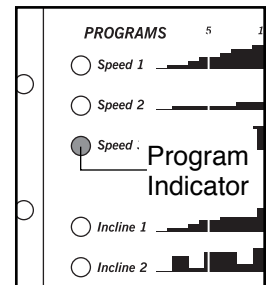

Note: When you are familiar with the console, you may go directly to step 6. While learning to use the console, please read all steps.

3 Enter your weight if desired.

When a program is selected, a weight setting will begin to flash in the CALORIES/PULSE display. If your weight is entered into the console, the CALORIES/PULSE display will be more accurate.



If you do not want to enter your weight, or if you have already entered your weight, press the ENTER button. If you want to enter your weight, press the SELECT buttons. When the correct weight is shown, press the ENTER button.

4 Enter your age if desired.

See step 4 on page 10.

5 Adjust the maximum incline or speed setting.

If you selected the Speed 1, Speed 2 or Speed 3 program: After an age setting is entered, a number will begin to flash in the SPEED display. This number shows the maximum speed that the walking belt will reach during the program. The maximum speed setting can be from 4 mph to 10 mph. If you want to change the maximum speed setting, press the SELECT buttons. Then, press the ENTER button.

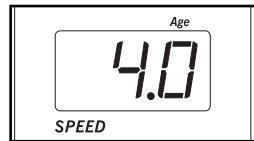

If you selected the Incline 1 or Incline 2 program: After an age setting is entered, a number will begin to flash in the DISTANCE/ INCLINE display. This number shows the maximum incline that the treadmill will reach during the program. The maximum incline setting can be from 5% to 10%. If you want to adjust the maximum incline setting, press the SELECT buttons. Then, press the ENTER button.

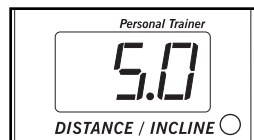

6 Press the START button or the SPEED + button

If you selected the Speed 1, Speed 2 or Speed 3 program: A moment after the START button or the SPEED + button is pressed, the walking belt will begin to move. Hold the handrails and begin walking. During the program, the speed of the walking belt will periodically change as shown by the program profile on the console. The incline of the treadmill can be changed as desired during the program with the INCLINE buttons.

The TIME display will show the time remaining in the program. When no time remains, the walking belt will slow to a stop and the program will be completed.

Note: If the program is too easy or too difficult, the current speed setting can be adjusted with the

SPEED buttons. To stop the program for a moment, press the PAUSE/STOP button. The displays will pause and the TIME display will begin to flash. To restart the program, press the START button or the SPEED + button. To end the program at any time, hold down the PAUSE/STOP button for two seconds. The console will then be in the same state as if the key had just been inserted.

If you selected the Incline 1 or Incline 2 program: A moment after the START button or the SPEED + button is pressed, the walking belt will begin to move and the treadmill will adjust to the first incline setting of the program (unless it is already at the first incline setting). Hold the handrails and begin walking. During the program, the incline of the treadmill will periodically change as shown by the program profile on the console. The speed of the walking belt can be changed as desired during the program with the SPEED buttons.

The TIME display will show the time remaining in the program. When no time remains, the walking belt will slow to a stop and the program will be completed.

Note: If the program is too easy or too difficult, the current incline setting can be adjusted with the INCLINE buttons. To stop the program for a moment, press the PAUSE/STOP button. The displays will pause and the TIME display will begin to flash. To restart the program, press the START button or the SPEED + button. To end the program at any time, hold down the PAUSE/STOP button for two seconds. The console will then be in the same state as if the key had just been inserted.

7 Follow your progress with the LED displays.

See step 7 on page 10.

8 When you are finished exercising, remove the key.

Make sure that the incline of the treadmill is at 3%. **The incline must be at 3% when the treadmill is folded to the storage position or the treadmill will be damaged.** Remove the key from the console and put it in a secure place. In addition, move the on/off switch to the off position (see page 9).

THE INFORMATION MODE

The console features an information mode that keeps track of the total time and distance accumulated on the treadmill. The information mode also allows you to switch the console from miles per hour to kilometers per hour.

To select the information mode, hold down the PAUSE/STOP button while inserting the key into the console. When the information mode is selected, the following information will be shown:

The TIME display will show the total number of hours that the treadmill has been used.



The SPEED display will show an "E" (for english miles) or an "M" (for metric kilometers). To change the unit of measurement, press the SPEED + button.

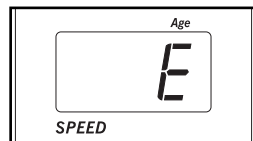

The DISTANCE/INCLINE display will show the total number of miles that the walking belt has moved.

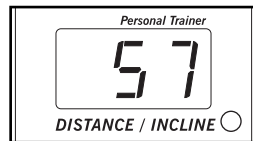

To exit the information mode, remove the key from the console.

THE OPTIONAL PULSE SENSORS

Two optional pulse sensors add even more features to the console. **To purchase one of the pulse sensors, refer to the card accompanying the treadmill.**

An optional hand pulse sensor mounts to the handlebar in front of the console, allowing you to measure your heart rate at any time during your workouts.

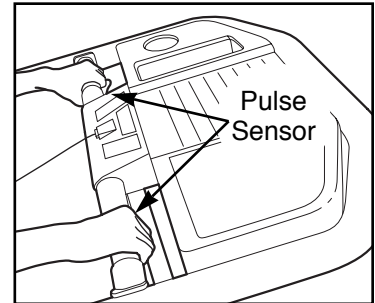

An optional chest pulse sensor can be worn during your workouts, for hands-free heart rate monitoring.

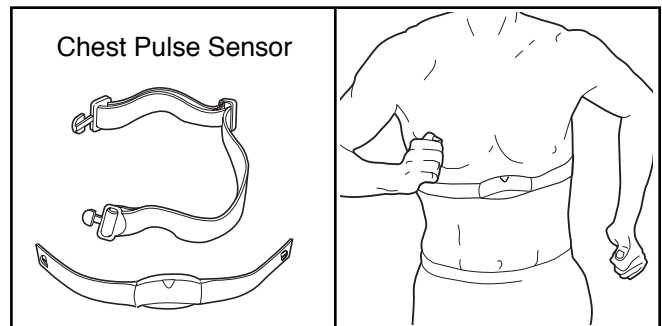

Note: The hand pulse sensor and the chest pulse sensor cannot be used simultaneously.

HOW TO FOLD AND MOVE THE TREADMILL

HOW TO FOLD THE TREADMILL FOR STORAGE

Before folding the treadmill, adjust the incline to the lowest position. If this is not done, the treadmill may be permanently damaged. Next, unplug the power cord. **Caution: You must be able to safely lift 45 pounds (20 kg) in order to raise, lower, or move the treadmill.**

1. Hold the treadmill in the locations shown at the right. **To decrease the possibility of injury, bend your legs and keep your back straight. As you raise the treadmill, make sure to lift with your legs rather than your back.** Raise the treadmill about halfway to the vertical position.

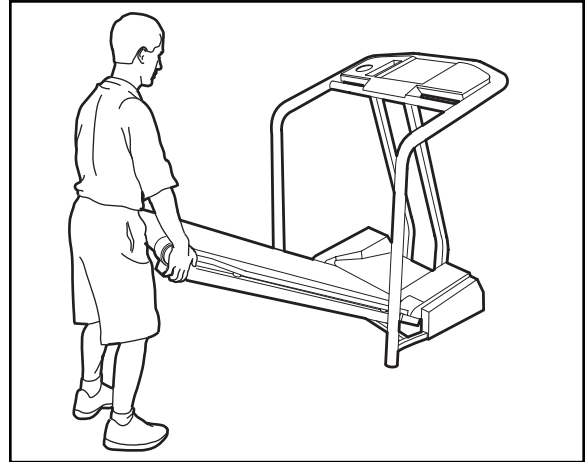

2. Move your right hand to the position shown, and hold the treadmill firmly. Using your left hand, push the storage latch to the left. Raise the treadmill until the storage latch snaps into the catch. **Make sure that the storage latch is inside of the catch.**

To protect the floor or carpet from damage, place a mat under the treadmill. Keep the treadmill out of direct sunlight. Do not leave the treadmill in the storage position in temperatures above 85° Fahrenheit.

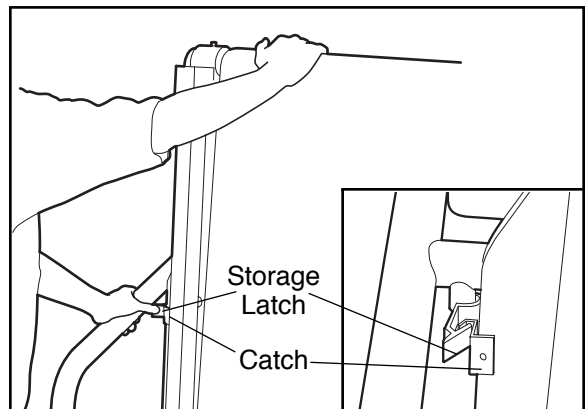

HOW TO MOVE THE TREADMILL

Before moving the treadmill, convert the treadmill to the storage position as described above. **Make sure that the storage latch is inside of the catch.**

1. Hold the handrails and place one foot on the base.
2. Tilt the treadmill back until it rolls freely on the front wheels. Carefully move the treadmill to the desired location. **To reduce the risk of injury, use extreme caution while moving the treadmill. Do not attempt to move the treadmill over an uneven surface.**
3. Place one foot on the base, and carefully lower the treadmill until it is resting in the storage position.



HOW TO LOWER THE TREADMILL FOR USE

1. Hold the upper end of the treadmill with your right hand as shown. Using your left hand, push the storage latch to the left. Pivot the treadmill until the storage latch is past the catch.

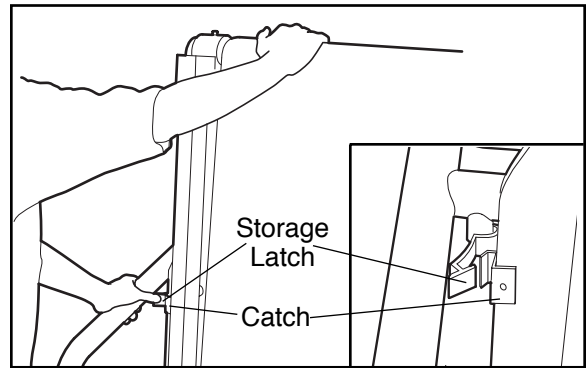

2. Hold the treadmill firmly with both hands, and lower the treadmill to the floor. **To decrease the possibility of injury, bend your legs and keep your back straight.**

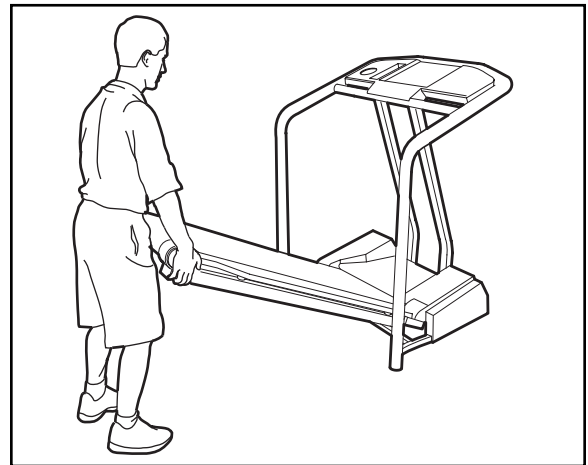

TROUBLE-SHOOTING AND MAINTENANCE

Most treadmill problems can be solved by following the simple steps below. Find the symptom that applies, and follow the steps listed. If further assistance is needed, call our toll-free HELPLINE at 1-800-736-6879, Monday through Saturday, 7 a.m. until 7 p.m. Central Time (excluding holidays).

PROBLEM

SOLUTION

1. The power does not turn on

a. Make sure that the power cord is plugged into a surge suppressor, and that the surge suppressor is plugged into a properly grounded outlet (see page 9). Use only a single-outlet surge suppressor that is UL 1449 listed as a transient voltage surge suppressor (TVSS). The surge suppressor must have a UL suppressed voltage rating of 400 volts or less and a minimum surge dissipation of 450 joules. The surge suppressor must be electrically rated for 120 volts AC and 15 amps.

b. Make sure that the key is fully inserted into the console.

c. Check the circuit breaker located on the frame near the power cord. If the switch protrudes as shown, the circuit breaker has tripped. To reset the circuit breaker, wait for five minutes and then press the switch back in.

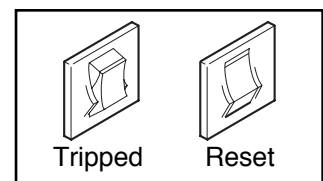

d. Check the on/off switch located on the frame near the power cord. The switch must be in the on position.

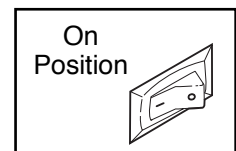

2. The power turns off during use

a. Check the circuit breaker (see c. above). If the circuit breaker has tripped, wait for five minutes and then press the switch back in.

b. Make sure that the power cord is plugged in.

c. Remove the key from the console and then reinsert it.

d. Make sure that the on/off switch is in the on position (see d. above).

3. The walking belt slows when walked on

a. Use only a UL-listed surge protector, rated at 15 amps, with a 14-gauge cord of five feet or less in length.

b. If the walking belt is overtightened, treadmill performance may decrease and the walking belt may be permanently damaged. Remove the key and **UNPLUG THE POWER CORD**. Using the included allen wrench, turn both rear roller adjustment bolts counterclockwise 1/4 of a turn. When the walking belt is properly tightened, you should be able to lift **the edges** of the walking belt 3 to 4 inches off the walking platform. Be careful to keep the walking belt centered. Plug in the power cord, insert the key and run the treadmill for a few minutes. Repeat until the walking belt is properly tightened.

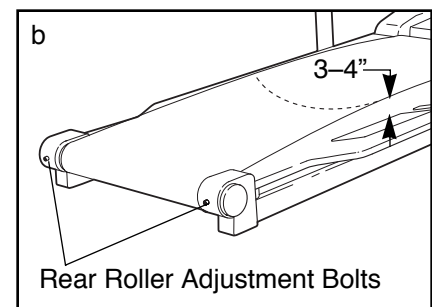

c. If the walking belt still slows when walked on, call our toll-free HELPLINE.

PROBLEM**SOLUTION****4. The walking belt is off-center or slips when walked on**

- a. If the walking belt has shifted to the left, first remove the key and **UNPLUG THE POWER CORD**. Using the allen wrench, turn the left rear roller adjustment bolt clockwise, and the right bolt counterclockwise, 1/4 of a turn each. Be careful not to overtighten the walking belt. Plug in the power cord, insert the key and run the treadmill for a few minutes. Repeat until the walking belt is centered.

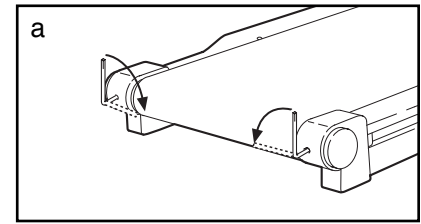

- b. If the walking belt has shifted to the right, first remove the key and **UNPLUG THE POWER CORD**. Using the allen wrench, turn the left rear roller adjustment bolt counterclockwise, and the right bolt clockwise, 1/4 of a turn each. Be careful not to overtighten the walking belt. Plug in the power cord, insert the key and run the treadmill for a few minutes. Repeat until the walking belt is centered.

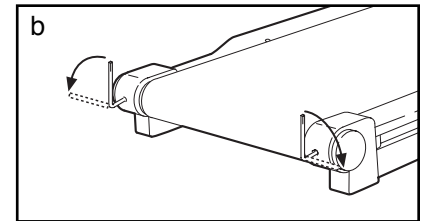

- c. If the walking belt slips when walked on, first remove the key and **UNPLUG THE POWER CORD**. Using the allen wrench, turn both rear roller adjustment bolts clockwise, 1/4 of a turn. When the walking belt is correctly tightened, you should be able to lift **the edges** of the walking belt 3 to 4 inches off the walking platform. Be careful to keep the walking belt centered. Plug in the power cord, insert the key and run the treadmill for a few minutes. Repeat until the walking belt is properly tightened.

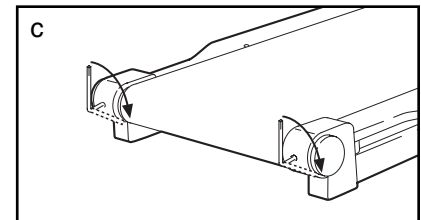
**5. An error code (“E1,” “E2,” “E3,” or “E4,”) appears in the SPEED display**

- a. If error code “E1,” “E2,” or “E3” appears in the SPEED display, remove the key, wait for ten seconds, and then reinsert it. If the error code appears again, call our toll-free HELPLINE. **Do not operate the treadmill until the problem is corrected.**
- b. Error code “E4” may appear in the SPEED display if the walking belt is moving at a slow speed and there is excessive stress on the motor. If this occurs, remove the key, wait for ten seconds, and then reinsert it. If you weigh over 200 pounds, it may also be helpful to increase the incline of the treadmill. If the error code appears again, call our toll-free HELPLINE. **Do not operate the treadmill until the problem is corrected.**

6. The walking belt becomes soiled

- a. Use a color-fast upholstery cleaner to clean the walking belt. Test the cleaner on a small area before cleaning the entire belt.

7. Bubbles form in the walking belt

- a. Due to variations in humidity and temperature, there is a possibility that bubbles may form in the walking belt. Although the bubbles will disappear with time, you may unplug the power cord, carefully insert a needle into the bubbles, and push the air out of the bubbles.

CONDITIONING GUIDELINES

⚠ WARNING: Before beginning this or any exercise program, consult your physician. This is especially important for individuals over the age of 35 or individuals with pre-existing health problems.

The following guidelines will help you to plan your exercise program. For more information about exercise, consult your physician or obtain a reputable book.

EXERCISE INTENSITY

Whether your goal is to burn fat or to strengthen your cardiovascular system, the key to achieving the desired results is to exercise with the proper intensity. The proper intensity level can be found by using your heart rate as a guide. The chart at the bottom of this page shows recommended heart rates for fat burning and aerobic exercise.

To find the proper heart rate for you, first find your age at the top of the chart (ages are rounded off to the nearest ten years). Next, find the three numbers below your age. The three numbers define your “training zone.” The lowest two numbers are recommended heart rates for fat burning, and the highest number is the recommended heart rate for aerobic exercise.

Fat Burning

To burn fat effectively, you must exercise at a relatively low intensity level for a sustained period of time. During the first few minutes of exercise, your body uses easily accessible carbohydrate calories for energy. Only after the first few minutes does your body begin to use stored fat calories for energy. If your goal is to burn fat, adjust the speed and incline of the treadmill until your heart rate is near the lowest number in your training zone.

For maximum fat burning, adjust the speed and incline until your heart rate is near the middle number in your training zone.

Aerobic Exercise

If your goal is to strengthen your cardiovascular system, your exercise must be “aerobic.” Aerobic exercise is activity that requires large amounts of oxygen for prolonged periods of time. This increases the demand on the heart to pump blood to the muscles, and on the lungs to oxygenate the blood. For aerobic exercise, adjust the speed and incline until your heart rate is near the highest number in your training zone.

HOW TO MEASURE YOUR HEART RATE

To measure your heart rate, stop exercising and place two fingers on your wrist as shown. Take a six-second heartbeat count, and multiply the result by ten to find your heart rate. (A six-second count is used because your heart rate drops quickly when you stop exercising.)

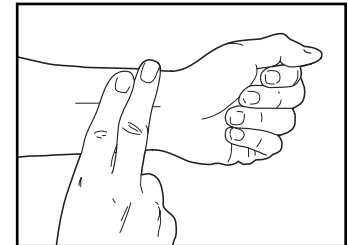

If your heart rate is too high or too low, adjust the speed or incline of the treadmill accordingly.

WORKOUT GUIDELINES

Each workout should include three parts: (1) a warm-up, (2) training zone exercise, and (3) a cool-down.

Warming Up

Begin each workout with five to ten minutes of stretching and light exercise to warm up. A proper warm-up increases your body temperature, heart rate and circulation in preparation for exercise.

Training Zone Exercise

After warming up, increase the intensity of your exercise until your heart rate is in your training zone for 20 to 30 minutes. Breathe regularly and deeply as you exercise—never hold your breath.

| AGE | 20 | 30 | 40 | 50 | 60 | 70 | 80 |
|----------|-----|-----|-----|-----|-----|-----|-----|
| FAT BURN | 125 | 120 | 115 | 110 | 105 | 95 | 90 |
| MAX BURN | 145 | 138 | 130 | 125 | 118 | 110 | 103 |
| AEROBIC | 165 | 155 | 145 | 140 | 130 | 125 | 115 |

Cooling Down

End each workout with five to ten minutes of stretching to cool down. This will develop muscle flexibility and will help to prevent post-exercise problems.

Exercise Frequency

To maintain or improve your condition, complete three workouts each week, with at least one day of rest between workouts. After a few months, you may complete up to five workouts each week if desired.

The key to success is to make exercise a regular and enjoyable part of your everyday life.

SUGGESTED STRETCHES

The correct form for several basic stretches is shown in the drawings at the right. Move slowly as you stretch—never bounce.

1. Toe Touch Stretch

Stand with your knees bent slightly and slowly bend forward from your hips. Allow your back and shoulders to relax as you reach down toward your toes as far as possible. Hold for 15 counts, then relax. Repeat 3 times. Stretches: Hamstrings, back of knees and back.

2. Hamstring Stretch

Sit with one leg extended. Bring the sole of the opposite foot toward you and rest it against the inner thigh of your extended leg. Reach toward your toes as far as possible. Hold for 15 counts, then relax. Repeat 3 times for both legs. Stretches: Hamstrings, lower back and groin.

3. Calf/Achilles Stretch

With one leg in front of the other, reach forward and place your hands against a wall. Keep your back leg straight and your back foot flat on the floor. Bend your front leg, lean forward and move your hips toward the wall. Hold for 15 counts, then relax. Repeat 3 times for both legs. To cause further stretching of the achilles tendons, bend your back leg as well. Stretches: Calves, achilles tendons and ankles.

4. Quadriceps Stretch

With one hand against a wall for balance, reach back and grasp one foot with your other hand. Bring your heel as close to your buttocks as possible. Hold for 15 counts, then relax. Repeat 3 times for both legs. Stretches: Quadriceps and hip muscles.

5. Inner Thigh Stretch

Sit with the soles of your feet together and your knees outward. Pull your feet toward your groin area as far as possible. Hold for 15 counts, then relax. Repeat 3 times. Stretches: Quadriceps and hip muscles.

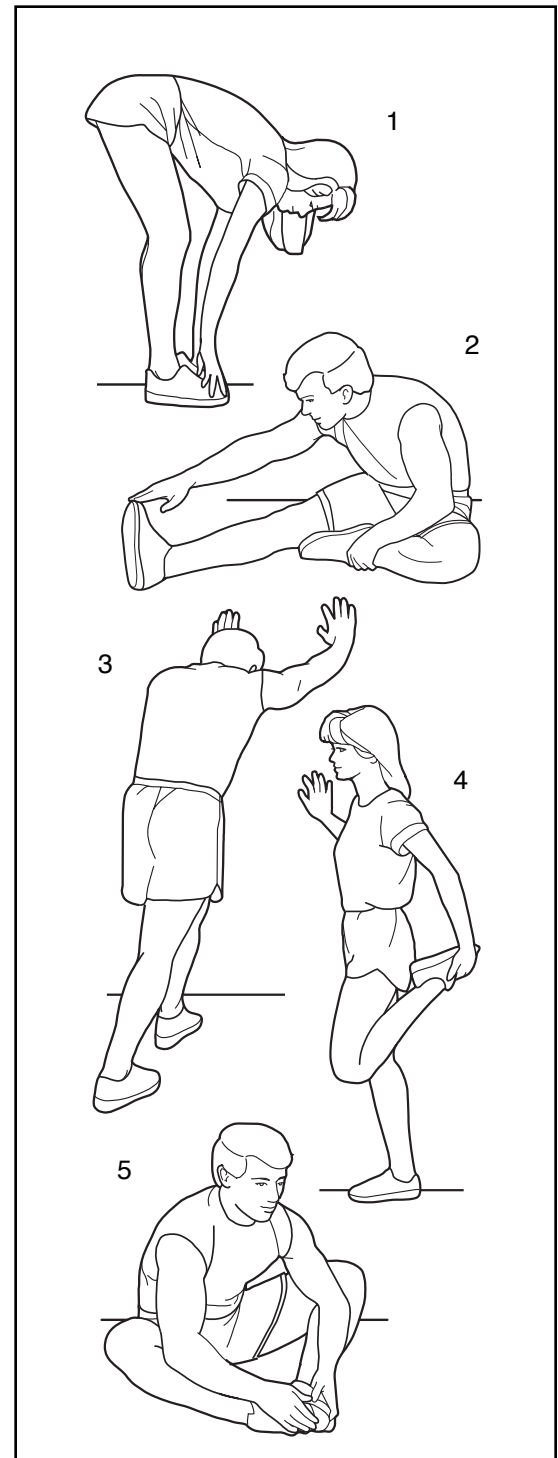

PART LIST—Model No. 831.297970

R0499A

| Key No. | Qty. | Description | Key No. | Qty. | Description | Key No. | Qty. | Description |
|---------|------|---------------------------|---------|------|--------------------------|---------|------|------------------------|
| 1 | 1 | Rear Roller | 51 | 1 | Power Supply w/Clips | 101 | 6 | Center Grip Tape |
| 2 | 6 | Isolator | 52 | 1 | Controller | 102 | 1 | Choke Bracket |
| 3 | 5 | Hood Screw | 53 | 1 | Power Cord Grommet | 103 | 2 | Console Screw, Long |
| 4 | 4 | Hood Bracket Clip | 54 | 1 | Power Cord | 104 | 3 | Incline Warning Decal |
| 5 | 1 | Handrail | 55 | 1 | Pulse Sensor Housing | 105 | 1 | Left Rear Grip Tape |
| 6 | 1 | Walking Platform | 56 | 2 | Handrail Bolt | 106 | 1 | Choke |
| 7 | 2 | Frame Pivot Bolt | 57 | 8 | Handrail/Pivot Washer | 107 | 1 | Motor Tension Bolt |
| 8 | 38 | Screw | 58 | 1 | Pulse Sensor Cap | 108 | 1 | Storage Catch Bolt |
| 9 | 2 | Rear Platform Screw | 59 | 1 | Console Base | 109 | 1 | Handrail Cap (right) |
| 10 | 2 | Cable Tie Clamp | 60 | 1 | Console | 110 | 1 | Storage Catch Nut |
| 11 | 6 | Small Screw | 61 | 1 | Electronics Bracket | 111 | 1 | Plastic Box |
| 12 | 1 | Releasable Tie | 62 | 2 | Latch Screw | 112 | 2 | Box Screw |
| 13 | 5 | 8" Cable Tie | 63 | 1 | Book Rack | 113 | 2 | Roller Guard |
| 14 | 1 | Belly Pan | 64 | 1 | Key/Clip | 114 | 1 | Handrail Cap (left) |
| 15 | 1 | Hood | 65 | 1 | Storage Latch | 115 | 2 | Belt Guide |
| 16 | 2 | Frame Pivot Spacer | 66 | 1 | Rear Roller Ground Wire | # | 1 | 8" Black Ground Wire |
| 17 | 2 | Console Bushing | 67 | 1 | Incline Warning Decal | # | 1 | 4" Black Wire, 2 F |
| 18 | 1 | Right Rear Grip Tape | 68 | 1 | Storage Catch | # | 1 | 20" White Wire, 2 F |
| 19 | 1 | Incline Leg | 69 | 1 | Incline Motor Spacer | # | 1 | 4" White Wire, M/F |
| 20 | 1 | Shock | 70 | 2 | Endcap Insert | # | 1 | 8" Blue Wire, 2 Female |
| 21 | 1 | Front Roller/Pulley | 71 | 1 | Wrench Clip | # | 1 | 4" Blue Wire, 2 F |
| 22 | 1 | Walking Belt | 72 | 1 | Allen Wrench | # | 1 | 8" Red Wire, M/F |
| 23 | 1 | Motor Tension Nut | 73 | 1 | Wire Harness Grommet | # | 1 | 4" Green F/Ring |
| 24 | 1 | Motor Star Washer | 74 | 2 | Upright Base Endcap | # | 1 | User's Manual |
| 25 | 1 | Motor Tension Washer | 75 | 1 | Motor Pivot Washer | | | |
| 26 | 6 | Incline Motor Bolt | 76 | 2 | Wheel Nut | | | |
| 27 | 1 | Motor | 77 | 2 | Front Wheel | | | |
| 28 | 1 | Motor Belt | 78 | 2 | Wheel Bolt | | | |
| 29 | 1 | Pulley/Flywheel/Fan | 79 | 4 | Base Pad | | | |
| 30 | 6 | Motor Pivot Nut | 80 | 1 | Left Front Grip Tape | | | |
| 31 | 1 | Front Roller Adjust. Bolt | 81 | 1 | Wire Harness | | | |
| 32 | 6 | Adjustment Washer | 82 | 1 | Upright/Base | | | |
| 33 | 1 | Motor Pivot Bolt | 83 | 1 | Incline Motor Plate | | | |
| 34 | 1 | Front Roller Adjust.Nut | 84 | 1 | Incline Motor Shield | | | |
| 35 | 1 | Speed Optic Disk | 85 | 1 | 4" Cable Tie | | | |
| 36 | 1 | Optic Switch Bracket | 86 | 1 | Incline Optic Disk | | | |
| 37 | 2 | Optic Switch Bolt | 87 | 1 | 23" Cable Tie | | | |
| 38 | 1 | Bracket Nut | 88 | 1 | Incline Motor | | | |
| 39 | 2 | Optic Switch | 89 | 1 | Incline Stop Bracket | | | |
| 40 | 1 | Optic Switch Star Washer | 90 | 1 | Right Front Grip Tape | | | |
| 41 | 2 | Optic Switch Nut | 91 | 2 | Photo Switch Wire | | | |
| 42 | 2 | Hood Bracket, Short | 92 | 1 | Frame | | | |
| 43 | 2 | Grommet | 93 | 1 | Right Endcap | | | |
| 44 | 4 | Plastic Stand-Off | 94 | 1 | Left Endcap | | | |
| 45 | 1 | Power Cord Bracket | 95 | 2 | Endcap Pad | | | |
| 46 | 1 | On/Off Switch | 96 | 1 | Motor-Controller Wire | | | |
| 47 | 1 | Circuit Breaker | 97 | 2 | Rear Roller Adjust. Bolt | | | |
| 48 | 2 | Handrail Endcap | 98 | 1 | Latch Decal | | | |
| 49* | 1 | Motor/Pulley/Fly./Fan | 99 | 6 | Platform Screw | | | |
| 50 | 2 | Hood Bracket (long) | 100 | 1 | Electronics Shield | | | |

* Includes all parts shown in the box.

These parts are not illustrated

Specifications are subject to change without notice.

EXPLODED DRAWING—Model No. 831.297970

R0499A

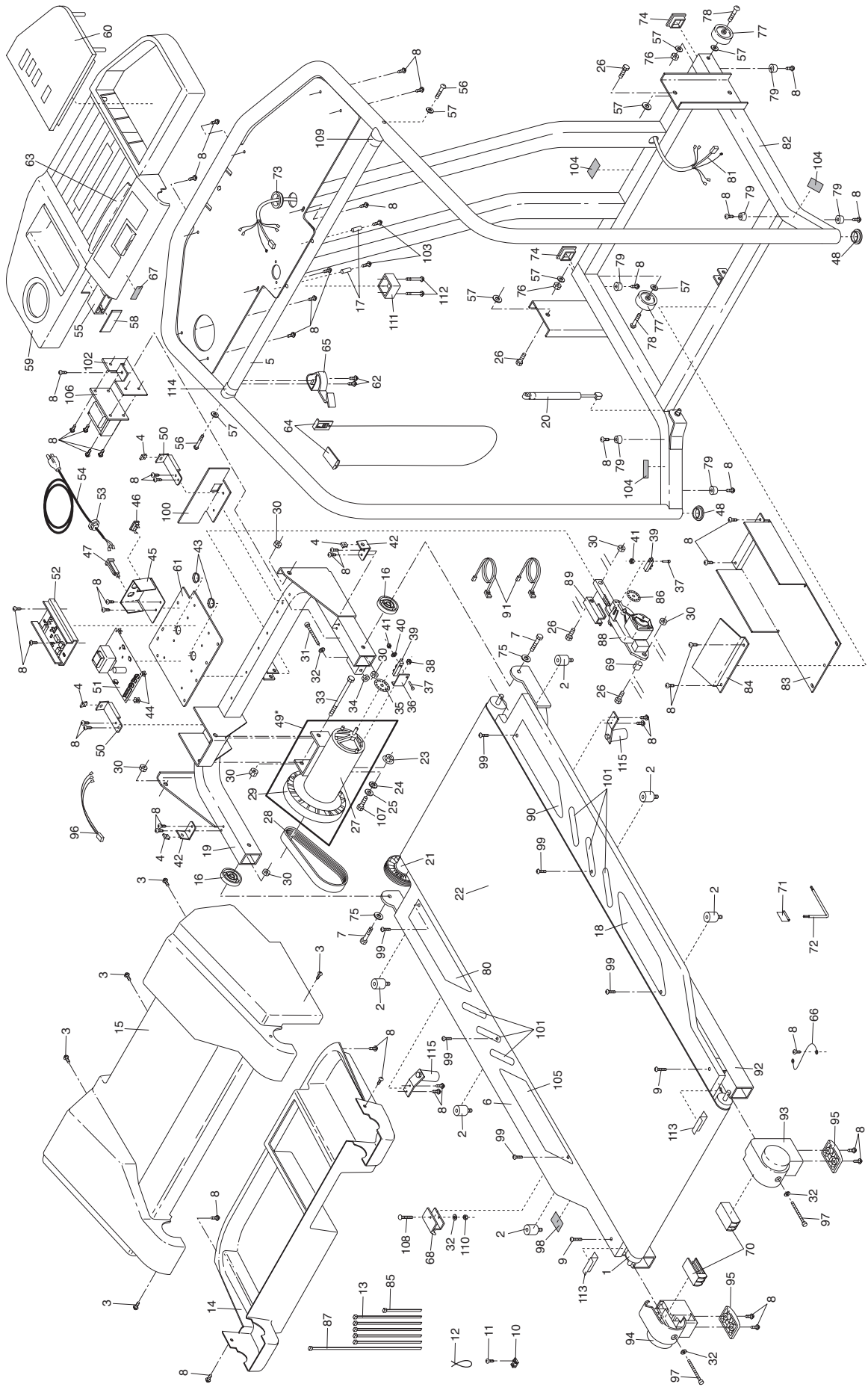



Model No. 831.297970

QUESTIONS?

If you find that:

- you need help assembling or operating the HealthRider® SOFTSTRIDER S200™ treadmill
- a part is missing
- or you need to schedule repair service

call our toll-free HELPLINE

1-800-736-6879

Monday–Saturday, 7 am–7 pm
Central Time (excluding holidays)

REPLACEMENT PARTS

If parts become worn and need to be replaced, call the following toll-free number

**1-800-FON-PART
(1-800-366-7278)**

The model number and serial number of your HealthRider® SOFTSTRIDER S200™ treadmill are listed on a decal attached to the frame. See the front cover of this manual to find the location of the decal.

All replacement parts are available for immediate purchase or special order when you visit your nearest SEARS Service Center. To request service or to order parts by telephone, call the toll-free numbers listed at the left.

When requesting help or service, or ordering parts, please be prepared to provide the following information:

- The NAME OF THE PRODUCT (HealthRider® SOFTSTRIDER S200™ treadmill)
- The MODEL NUMBER OF THE PRODUCT (831.297970)
- The KEY NUMBER AND DESCRIPTION OF THE PART (see the EXPLODED DRAWING and PART LIST included in this manual)

FULL 90 DAY WARRANTY

For 90 days from the date of purchase, if failure occurs due to defect in material or workmanship in this SEARS TREADMILL EXERCISER, contact the nearest SEARS Service Center throughout the United States and SEARS will repair or replace the TREADMILL EXERCISER, free of charge.

This warranty does not apply when the TREADMILL EXERCISER is used commercially or for rental purposes.

This warranty gives you specific legal rights, and you may also have other rights which vary from state to state.

SEARS, ROEBUCK AND CO., DEPT. 817WA, HOFFMAN ESTATES, IL 60179

Free Manuals Download Website

<http://myh66.com>

<http://usermanuals.us>

<http://www.somanuals.com>

<http://www.4manuals.cc>

<http://www.manual-lib.com>

<http://www.404manual.com>

<http://www.luxmanual.com>

<http://aubethermostatmanual.com>

Golf course search by state

<http://golfingnear.com>

Email search by domain

<http://emailbydomain.com>

Auto manuals search

<http://auto.somanuals.com>

TV manuals search

<http://tv.somanuals.com>