

SOFT STRIDER™

by **HEALTHRIDER®**

Model No. DRTL25060

Serial No. _____

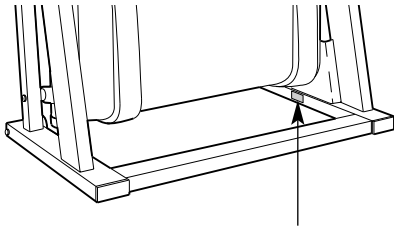

Serial Number Decal

QUESTIONS?

As a manufacturer, we are committed to providing complete customer satisfaction. If you have questions, or find that there are missing or damaged parts, we will guarantee complete satisfaction through direct assistance from our factory.

TO AVOID UNNECESSARY DELAYS, PLEASE CALL DIRECT TO OUR TOLL-FREE CUSTOMER HOT LINE.

The trained technicians on our customer hot line will provide immediate assistance, free of charge.

CUSTOMER HOT LINE:

1-800-999-3756

Mon.–Fri., 6 a.m.–6 p.m. MST



⚠ CAUTION

Read all precautions and instructions in this manual before using this equipment. Save this manual for future reference.

USER'S MANUAL

TABLE OF CONTENTS

IMPORTANT PRECAUTIONS	2
BEFORE YOU BEGIN	4
ASSEMBLY	5
GROUNDING INSTRUCTIONS	7
CONSOLE OPERATION	8
HOW TO FOLD AND MOVE THE TREADMILL	16
TROUBLE-SHOOTING	17
CONDITIONING GUIDELINES	18
ORDERING REPLACEMENT PARTS	Back Cover
LIMITED WARRANTY	Back Cover

Note: An EXPLODED DRAWING and a PART LIST are attached to the center of this manual. Please save them for future reference.

IMPORTANT PRECAUTIONS

⚠ WARNING: To reduce the risk of burns, fire, electric shock, or injury to persons, read the following important precautions and information before operating the treadmill.

1. It is the responsibility of the owner to ensure that all users of this treadmill are adequately informed of all warnings and precautions.
2. Use the treadmill only as described in this manual.
3. Place the treadmill on a level surface, with eight feet of clearance behind it. Do not place the treadmill on any surface that blocks air openings. To protect the floor or carpet from damage, place a mat under the treadmill.
4. Keep the treadmill indoors, away from moisture and dust. Do not put the treadmill in a garage or covered patio, or near water.
5. Do not operate the treadmill where aerosol products are used or where oxygen is administered.
6. Keep children and pets away from the treadmill at all times.
7. The treadmill should not be used by persons weighing more than 250 pounds.
8. Never allow more than one person on the treadmill at a time.
9. Wear appropriate exercise clothing when using the treadmill. Do not wear loose clothing that could become caught in the treadmill. Athletic support clothes are recommended for both men and women.
10. Always wear athletic shoes when using the treadmill—never use the treadmill with bare feet, wearing only stockings, or in sandals. For maximum walking belt life, never use shoes with heavy treads.
11. When connecting the power cord (see page 7), plug the power cord into a surge protector (not included) and plug the surge protector into a grounded circuit capable of carrying 15 or more amps. No other appliance should be on the same circuit.
12. Use only a UL-listed surge protector, rated at 15 amps, with a 14-gauge cord of five feet or less in length. Do not use an extension cord.
13. Keep the power cord and the surge protector away from heated surfaces.
14. Never move the walking belt while the power is turned off. Do not operate the treadmill if the power cord or plug is damaged, or if the treadmill is not working properly. (See BEFORE YOU BEGIN on page 4 if the treadmill is not working properly.)

15. Never start the treadmill while you are standing on the walking belt.
16. Always hold the handrails when you are running on the treadmill. When you are walking on the treadmill, hold the handrails or use the included wrist weights.
17. Do not perform advanced exercises with weights at speeds higher than a walk. Using weights and not holding the handrails may compromise your ability to maintain your balance. Advanced exercises using weights should be attempted only by experienced users.
18. The treadmill is capable of high speeds. Adjust the speed in small increments to avoid sudden jumps in speed.
19. To reduce the possibility of the treadmill overheating, do not operate the treadmill continuously for longer than one hour.
20. Never leave the treadmill unattended while it is running. Always remove the key and move the on/off switch to the "off" position when the treadmill is not in use. (See the drawing on page 4 for the location of the on/off switch.)
21. Never insert any object into any opening.
22. Do not attempt to raise, lower, or move the treadmill until it is properly assembled. (See ASSEMBLY on pages 5 and 6, and HOW TO MOVE THE TREADMILL on page 16.) You must be able to safely lift 45 pounds (20 kg) to raise, lower, or move the treadmill.
23. When folding or moving the treadmill, make sure that the storage latch is fully closed.
24. Inspect and tighten all parts of the treadmill every three months.
25. Always unplug the power cord before performing the maintenance and adjustment procedures described in this manual. Never remove the belly pan unless instructed to do so by an authorized service representative. Servicing other than the procedures in this manual should be performed by an authorized service representative only.
26. The treadmill is intended for in-home use only. Do not use the treadmill in any commercial, rental, or institutional setting.

▲ WARNING: Before beginning this or any exercise program, consult your physician. This is especially important for persons over the age of 35 or persons with pre-existing health problems. Read all instructions before using. HealthRider assumes no responsibility for personal injury or property damage sustained by or through the use of this product.

SAVE THESE INSTRUCTIONS

The decals shown at the right and below have been placed on your treadmill. If one of the decals is missing, or if it is not legible, please call our Customer Service Department at 1-800-999-3756 to order a free replacement decal. Apply the decal in the location shown.

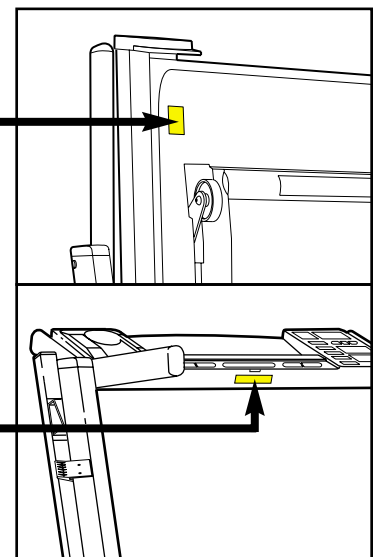
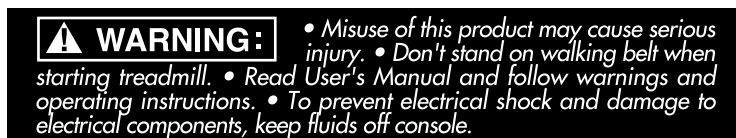
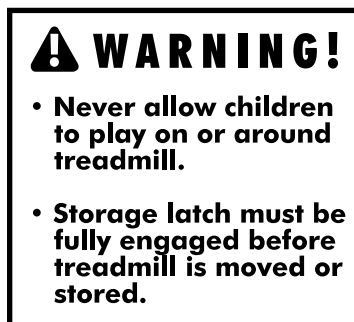

BEFORE YOU BEGIN

Congratulations for purchasing the SOFTSTRIDER™ treadmill by HealthRider®. The SOFTSTRIDER™ treadmill offers an impressive array of features that will help you to improve your health and fitness in the convenience of your home. From the advanced console to the ultra-soft walking belt, the SOFTSTRIDER™ is designed to make each workout more effective and enjoyable. And when you're not exercising, the SOFTSTRIDER™ can be folded away, taking less than half the space of conventional treadmills.



For your benefit, read this manual carefully before using the SOFTSTRIDER™ treadmill. If you have

additional questions, please call our Customer Service Department toll-free at 1-800-999-3756, Monday through Friday, 6 a.m. until 6 p.m. Mountain Time (excluding holidays). To help us assist you, please note the product model number and serial number before calling. The model number is DRTL25060. The serial number can be found on a decal attached to the treadmill (see the front cover of this manual for the location).

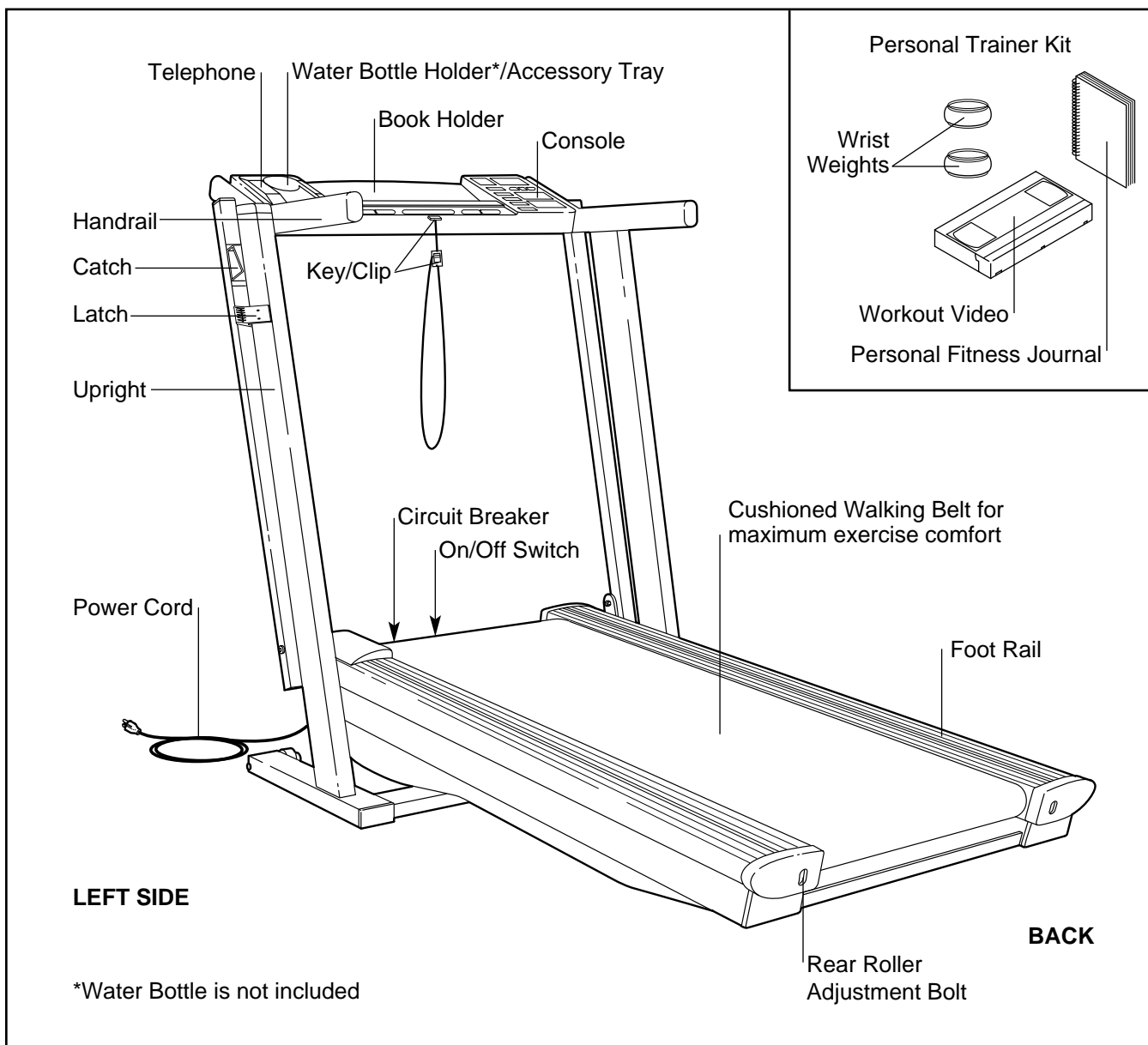
Before reading further, please familiarize yourself with the parts that are labeled in the drawing below.

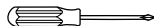

ASSEMBLY

Assembly requires two people. Set the treadmill in a cleared area and remove all packing materials. Do not dispose of the packing materials until assembly is completed. **Assembly requires only a phillips screwdriver**  **and wire cutters**  **(not included).**

1. Using wire cutters, cut the cable tie from each upright.

Attach the Storage Latch (41) to the left upright with the two Latch Screws (12). **Make sure that the ribs of the Storage Latch interlock with the ribs of the Storage Latch Catch (40).** If necessary, slide the Latch forward or backward slightly. Firmly tighten the Latch Screws.

2. **With the help of a second person,** carefully lay the treadmill on its right side as shown. (Do not lay the treadmill on its left side or the Storage Latch attached in step 1 may be damaged.) Attach five Base Pads (109) to the bottom of the Base (81) in the indicated locations. Note: One additional Base Pad may be included.

3. **With the help of a second person,** carefully raise the treadmill to the upright position. Hold the upper end of the treadmill with your right hand as shown. Using your left hand, pull the Storage Latch (41) outward. Pivot the treadmill until the Storage Latch is out of the Catch (40).

4. Hold the treadmill firmly with both hands, and lower the treadmill to the floor. **To decrease the possibility of injury, bend your legs and keep your back straight.**

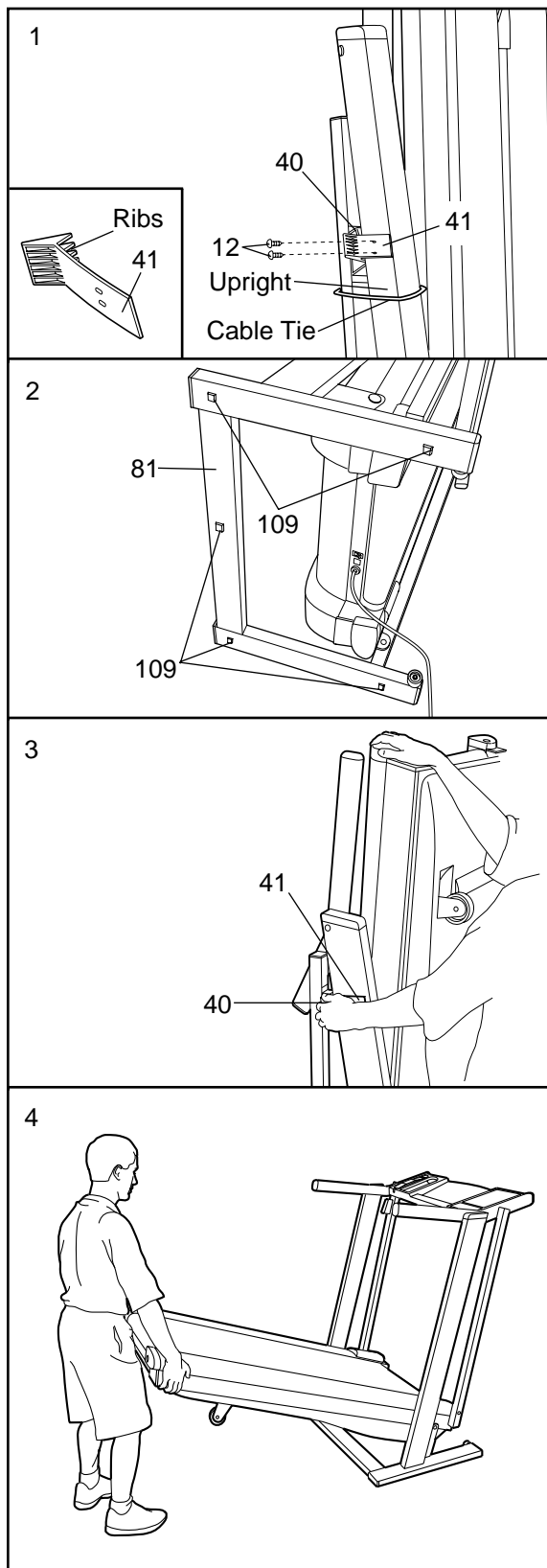

5. Locate the telephone cord extending from the lower end of the left Link Arm (1). Connect the telephone cord to your telephone extension cord (not included). Plug your telephone extension cord into a **standard (analog)** telephone jack. Call your local telephone company if you have any questions on the type of jack you have. Remove the tie attaching the telephone cord to the left Link Arm.

Refer to the inset drawing. Make sure that the packing material is removed from the Telephone (74). Set the Telephone in the Console (77).

6. Remove the paper backing from the Adhesive Clip (95). Press the Adhesive Clip onto the Frame (83) in the indicated location. Press the Allen Wrench (94) into the Adhesive Clip. The use of the Allen Wrench is described on page 18.

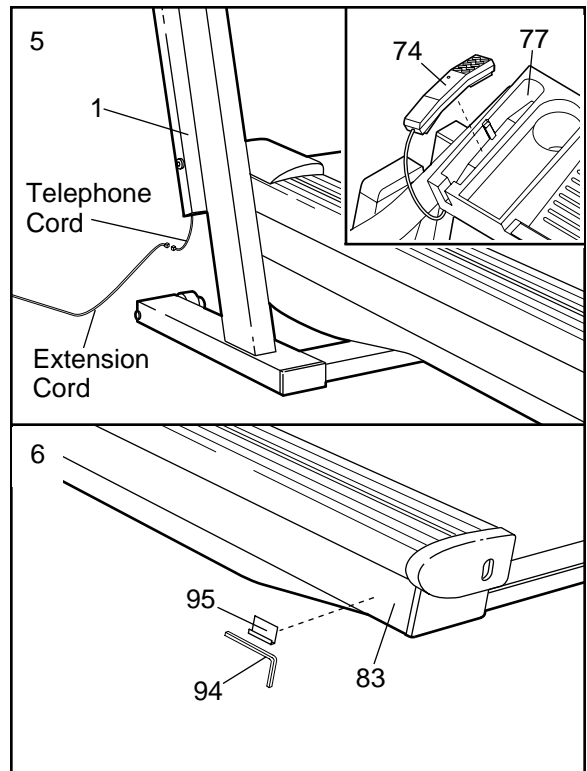

Make sure that all parts are tightened before you use the treadmill. The use of all remaining parts will be explained in later sections of this manual. **Note: Place a mat beneath the treadmill to protect the floor or carpet.**

GROUNDING INSTRUCTIONS

THE PERFORMANT LUBE™ WALKING BELT

Your treadmill features a walking belt coated with PERFORMANT LUBE™, a high-performance lubricant.

IMPORTANT: Never apply silicone spray or other substances to the walking belt or the walking platform. They will deteriorate the walking belt and cause excessive wear.

HOW TO PLUG IN THE POWER CORD

⚠ DANGER: Improper connection of the equipment-grounding conductor can result in an increased risk of electric shock. Check with a qualified electrician or serviceman if you are in doubt as to whether the product is properly grounded. Do not modify the plug provided with the product—if it will not fit the outlet, have a proper outlet installed by a qualified electrician.

Your treadmill, like any other type of sophisticated electronic equipment, can be seriously damaged by sudden voltage changes in your home's power. Voltage surges, spikes, and noise interference can result from weather conditions or from other appliances being turned on or off.

To decrease the possibility of your treadmill being damaged, always use a surge protector (not included) with your treadmill.

Surge protectors are sold at most hardware stores and department stores. Use only a UL-listed surge protector, rated at 15 amps, with a 14-gauge cord of five feet or less in length.

This product must be grounded. If it should malfunction or break down, grounding provides a path of least resistance for electric current to reduce the risk of

electric shock. This product is equipped with a cord having an equipment-grounding conductor and a grounding plug. **Plug the power cord into a surge protector, and plug the surge protector into an appropriate outlet that is properly installed and grounded in accordance with all local codes and ordinances.**

This product is for use on a nominal 120-volt circuit, and has a grounding plug that looks like the plug illustrated in drawing 1 below. A temporary adapter that looks like the adapter illustrated in drawing 2 may be used to connect the surge protector to a 2-pole receptacle as shown in drawing 2 if a properly grounded outlet is not available.

The temporary adapter should be used only until a properly grounded outlet (drawing 1) can be installed by a qualified electrician.

The green-colored rigid ear, lug, or the like extending from the adapter must be connected to a permanent ground such as a properly grounded outlet box cover. Whenever the adapter is used it must be held in place by a metal screw. **Some 2-pole receptacle outlet box covers are not grounded. Contact a qualified electrician to determine if the outlet box cover is grounded before using an adapter.**

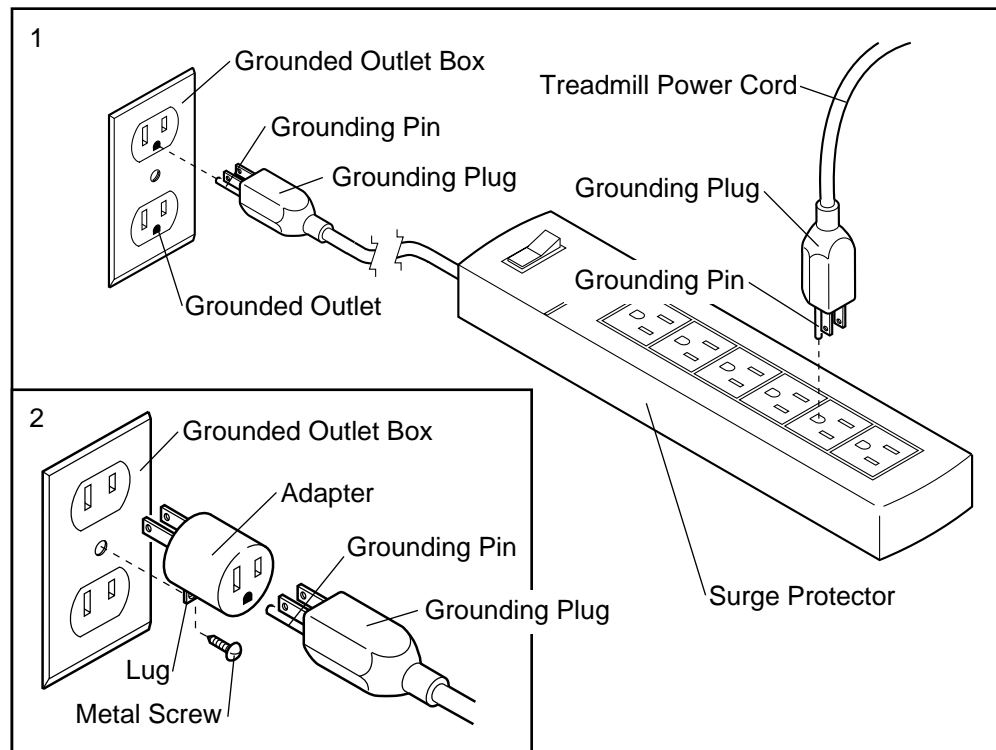

CONSOLE OPERATION

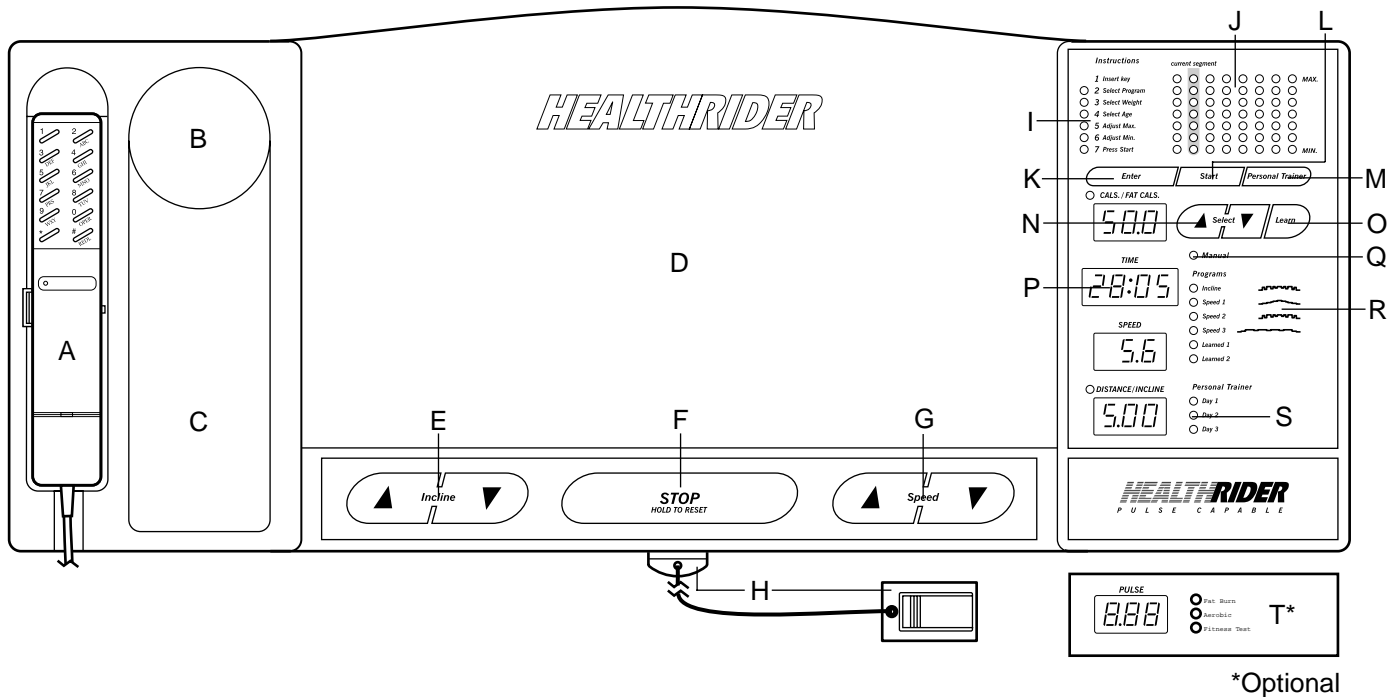

*Optional

⚠ CAUTION: Before operating the console, read the following precautions.

- Do not stand on the walking belt when turning on the power or starting the walking belt.
- Always wear the clip (see H above) while operating the treadmill. If the key is pulled from the console, the walking belt will stop.
- The treadmill is capable of high speeds. Adjust the speed in small increments.
- To reduce the risk of electric shock, keep the console dry, avoid spilling liquids on the console, and use only a sealed water bottle.

FEATURES OF THE CONSOLE

The treadmill console offers an impressive array of features designed to make your workouts more effective and enjoyable.

When the console is in the manual mode, the speed and incline of the treadmill can be changed with a touch of a button. As you exercise, large LED displays will provide continuous exercise feedback. The console even includes a built-in telephone that allows you to answer or make calls without leaving the treadmill.

The console also offers four preset workout programs. One program automatically controls the incline of the treadmill and the other three programs control the speed of the treadmill as they guide you through effective workouts. You can even create your own workout programs and store them in the console's memory for future use.

The SOFTSTRIDER™ also features exclusive Personal Trainer programs. Simply mail the included personal profile to E-Coach®, and a personal trainer will provide you with instructions for activating a workout program designed to help you reach your specific fitness goals.

An optional pulse kit adds even more features to the treadmill. The kit includes a state-of-the-art chest strap pulse monitor, a receiver, and a plug-in pulse module. After easy installation of the pulse kit, an LED display will track your heart rate throughout your workouts. The pulse kit also includes three additional workout programs: the Fat Burn program for intensive fat-burning workouts, the Aerobic program for maximum cardiovascular benefits, and the unique Fitness Test program that measures your relative fitness level. **To purchase the optional pulse kit, refer to the card accompanying the treadmill.**

Note: If there is a thin layer of clear plastic on the face of the console, remove it before using the console.

DIAGRAM OF THE CONSOLE

Refer to the drawing at the top of page 8.

- A. Telephone—The built-in telephone allows you to answer or make telephone calls without leaving the treadmill. The telephone can also be used to call E-Coach® for a Personal Trainer program.
- B. Water Bottle Holder—Keeps your water bottle handy during your workouts.
- C. Accessory Tray—Holds your radio or other items.
- D. Reading Rack—Allows you to enjoy your favorite magazine or read a book while you get in shape.
- E. Incline Buttons—These buttons control the incline of the treadmill. Each time one of the buttons is pressed, the incline will change by 0.5%. The incline range is 2% to 10%.
- F. Stop Button—This button is used to stop the walking belt. If the button is pressed once, the values of the LED displays will be retained. If the button is held down for two seconds, the elapsed time, distance, incline, and numbers of calories and fat calories burned will be reset.
- G. Speed Buttons—These buttons control the speed of the walking belt. Each time one of the buttons is pressed, the speed will change by 0.1 mph. The speed range of the walking belt is 1 mph to 10 mph.
- H. Key with Clip—This key turns the console on and off. The attached clip is designed to be worn on your waistband. If the key is pulled from the console, the power will automatically turn off.
- I. Operating Instruction Indicators—These indicators will guide you through basic console operation. Note: The SELECT AGE indicator is used only with the optional pulse kit.
- J. Program Display—This display tracks your progress during workout programs, and shows upcoming speed or incline changes.
- K. Enter Button—This button is used to enter selections.
- L. Start Button—This button starts the walking belt.
- M. Personal Trainer Button—This button is used to activate Personal Trainer Programs. (See PERSONAL TRAINER PROGRAMS on page 15.)
- N. SELECT Buttons—These buttons are used to make various selections.
- O. Learn Button—This button is used to program the Learned 1 and Learned 2 programs.
- P. Monitor Displays—The large LED displays provide continuous feedback of elapsed time, speed, distance, incline, and the numbers of calories and fat calories you have burned.
- Q. Manual/Program Indicators—These indicators show whether the manual mode or one of the workout programs is selected.
- R. Program Profiles—These profiles show how the speed or incline of the treadmill will change during workout programs. During the Speed 1 program, for example, the speed will gradually increase during the first half of the program, and then gradually decrease during the last half.
- S. Personal Trainer Program Indicators—These indicators show when a Personal Trainer program is selected. (See PERSONAL TRAINER PROGRAMS on page 15.)
- T. Optional Pulse Kit—An optional pulse kit includes a state-of-the-art chest strap pulse monitor, a receiver, and a plug-in pulse module. After easy installation of the pulse kit, an LED display will track your heart rate during your workouts. The pulse kit also includes three additional workout programs: the Fat Burn program, the Aerobic program, and the unique Fitness Test program. **To purchase the optional pulse kit, refer to the card accompanying the treadmill.**

HOW TO TURN ON THE POWER

Make sure that the on/off switch located on the front of the treadmill is in the "on" position.

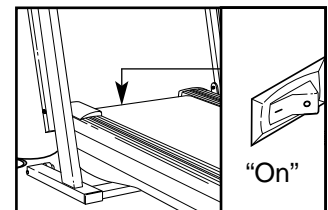

Next, make sure that the power cord is properly plugged in (see page 7).

Note: If the key is in the console when the power cord is plugged in, the letters "PO" will flash in the CALORIES/FAT CALORIES display. If this occurs, remove the key.

Step onto the foot rails of the treadmill. Find the clip attached to the key, and slide the clip onto the waistband of your clothing. Insert the key fully into the console.

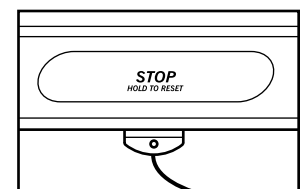

HOW TO USE THE MANUAL MODE

1 Insert the key fully into the console.

See HOW TO TURN ON THE POWER on page 9. Note: When you are familiar with the console, you may go directly to step 4. While learning to use the console, please read and follow all steps.

2 Select the MANUAL mode.

When the key is first inserted, the SELECT PROGRAM indicator and the MANUAL indicator will begin to flash. (Note: If a workout program has been selected, press the SELECT Δ or ∇ button repeatedly until the MANUAL indicator is flashing.) To select the manual mode, press the ENTER button while the MANUAL mode indicator is flashing.

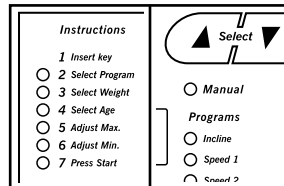

3 Enter your weight if desired.

After the manual mode is selected, the SELECT WEIGHT indicator and the current weight setting will begin to flash. Although it is not necessary to enter your weight to use the manual mode, the CALORIES/FAT CALORIES display will be more accurate if your weight is entered.

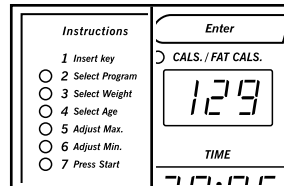

If you do not want to enter your weight, press the ENTER button and go to step 4. If you want to enter your weight, press the SELECT Δ or ∇ button. Each time one of the buttons is pressed, the weight setting will change by 1 pound. If one of the buttons is held down, the weight setting will change in increments of 5 pounds. When the correct weight is shown, press the ENTER button.

4 Press the START button.

After you have entered your weight, the PRESS START indicator will begin to flash. Press the START button once. After a moment, the walking belt will begin to move at 1.0 mph. Hold the handrails and begin walking. Change the speed of the walking

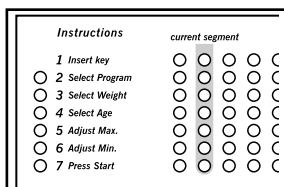

belt as desired by pressing the SPEED buttons. Each time one of the buttons is pressed, the speed will change by 0.1 mph. The speed range of the walking belt is 1 mph to 10.0 mph. Note: The walking belt can also be started by pressing the SPEED Δ button.

To stop the walking belt, press the STOP button once. All displays will pause and the TIME display will begin to flash. To restart the walking belt, press the SPEED Δ button. Note: To stop the walking belt and reset all displays, hold down the STOP button for two seconds. The console will then be in the same state as if the key had just been inserted.

Note: When one of the SPEED buttons is pressed, the SPEED display will show the selected speed setting for seven seconds. The display will then show the actual speed of the walking belt.

5 Adjust the incline if desired.

To vary the intensity of your exercise, the incline of the treadmill can be changed with the INCLINE buttons. Each time one of the buttons is pressed, the incline will change by 0.5%. The incline range is 2% to 10%. Note: The incline can be changed only while the walking belt is moving. After the INCLINE buttons are pressed, it may take a few seconds for the treadmill to reach the selected incline setting. Any time that the INCLINE buttons are pressed, the DISTANCE/INCLINE display will show the incline setting for seven seconds.

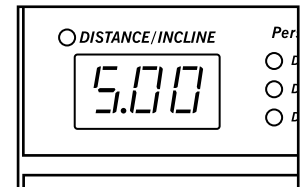

6 Follow your progress with the LED displays.

CALORIES/FAT CALORIES display—This display shows the numbers of calories and fat calories you have burned. (See BURNING FAT on page 19 for an explanation of fat calories.) Every seven seconds, the display will change from one number to the other. The indicator beside the display will light when the number of calories is shown.



TIME display—This display shows the total time that the walking belt has been moving.



SPEED display—This display shows the current speed of the walking belt. NOTE: When the SPEED buttons are pressed, the display will show the selected speed setting for seven seconds. The display will then show the actual speed of the walking belt.

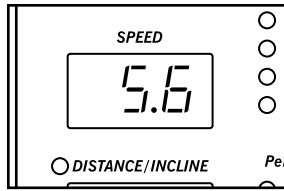

Note: The speed can be displayed in either miles per hour or kilometers per hour. To change the unit of measurement, hold down the SPEED ▽ button while inserting the key into the console. An “E” (for english–miles) or an “M” (for metric–kilometers) will appear in the SPEED display. Press the LEARN button to change the unit of measurement. When the desired unit of measurement is selected, remove and then reinsert the key.

DISTANCE/INCLINE display—This display shows the distance that the walking belt has moved and the current incline of the treadmill. Every seven seconds, the display will change from one number to the other. The indicator beside the display will light when the distance is shown. Note: When the INCLINE buttons are pressed, the display will change to show the selected incline setting.

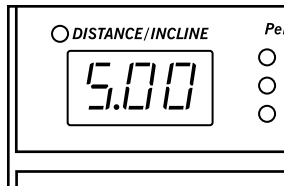

Note: If the speed is displayed in miles per hour, the distance will be displayed in miles. If the speed is displayed in kilometers per hour, the distance will be displayed in kilometers. (See SPEED DISPLAY above.)

7 When you are finished exercising, stop the walking belt and remove the key.

Step onto the foot rails, stop the walking belt, and remove the key from the console. Store the key in a safe place. In addition, move the on/off switch to the “off” position.

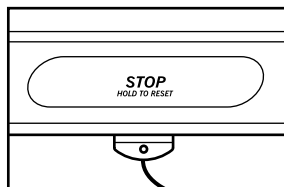

HOW TO USE THE INCLINE PROGRAM AND THE SPEED PROGRAMS

The Incline program automatically controls the incline of the treadmill as it guides you through an effective workout. The Speed 1, Speed 2, and Speed 3 programs automatically control the speed of the treadmill. The program profiles printed on the console show how the incline or speed will change during each program.

Note: To use the Learned 1 and Learned 2 programs, see pages 13 and 14. To use a Personal Trainer program, see page 15.

1 Insert the key fully into the console.

See HOW TO TURN ON THE POWER on page 9.

2 Select the desired program.

To select a program, the SELECT PROGRAM indicator must be flashing. If necessary, hold down the STOP button until the SELECT PROGRAM

Instructions	Programs
<input type="radio"/> 1 Insert key	<input type="radio"/> Incline
<input type="radio"/> 2 Select Program	<input type="radio"/> Speed 1
<input type="radio"/> 3 Select Weight	<input type="radio"/> Speed 2
<input type="radio"/> 4 Select Age	<input type="radio"/> Speed 3
<input type="radio"/> 5 Adjust Max.	<input type="radio"/> Learned 1
<input type="radio"/> 6 Adjust Min.	<input type="radio"/> Learned 2
<input type="radio"/> 7 Press Start	

indicator is flashing. Next, press the SELECT △ or ▽ button repeatedly until the desired program indicator is flashing. For example, to select the Speed 1 program, press the SELECT buttons until the SPEED 1 indicator is flashing. Then, press the ENTER button.

A simplified profile of the program you have selected will be shown in the program display in the upper right corner of the console. The TIME display will show how long the program will last.

3 Enter your weight if desired.

After a program is selected, the SELECT WEIGHT indicator and the current weight setting will begin to flash. Although it is not necessary to enter your weight to use a program, the CALORIES/FAT CALORIES display will be more accurate if your weight is entered.

Instructions	Enter
<input type="radio"/> 1 Insert key	<input type="radio"/> CALS./FAT CALS.
<input type="radio"/> 2 Select Program	129
<input type="radio"/> 3 Select Weight	TIME
<input type="radio"/> 4 Select Age	77.77
<input type="radio"/> 5 Adjust Max.	
<input type="radio"/> 6 Adjust Min.	
<input type="radio"/> 7 Press Start	

If you do not want to enter your weight, press the ENTER button and go to step 4. If you want to enter your weight, press the SELECT buttons. When the correct weight is shown, press the ENTER button.

4 Adjust the maximum incline or speed setting.

After your weight is entered, the ADJUST MAX. indicator will flash and a number will appear in the CALORIES/FAT CALORIES display. This number shows the maximum incline or speed that the treadmill will reach during the program.

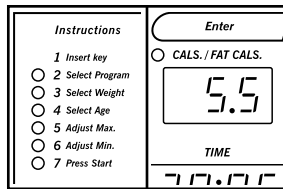

If you selected the Incline program, the maximum incline setting can be from 5% to 10%. If you want to change the maximum incline setting, press the SELECT buttons. Then, press the ENTER button.

If you selected the Speed 1, Speed 2, or Speed 3 program, the maximum speed setting can be from 2.5 mph to 10 mph. If you want to change the maximum speed setting, press the SELECT buttons. Then, press the ENTER button.

5 Adjust the minimum incline or speed setting.

After the maximum setting is adjusted, the ADJUST MIN. indicator will begin to flash and a number will appear in the CALORIES/FAT CALORIES display. This number shows the minimum incline or speed that the treadmill will reach during the program.

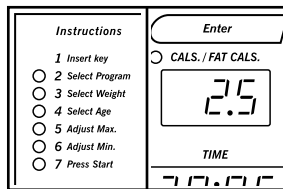

If you selected the Incline program, the minimum incline setting can be from 2% to 7%. (Note: There must be a difference of at least 3% between the minimum and maximum settings.) If you want to change the minimum incline setting, press the SELECT buttons. Then, press the ENTER button.

If you selected the Speed 1, Speed 2, or Speed 3 program, the minimum speed setting can be from 1 mph to 8.5 mph. (Note: There must be a difference of at least 1.5 mph between the minimum and maximum settings.) If you want to change the minimum speed setting, press the SELECT buttons. Then, press the ENTER button.

6 Press the START button.

After the maximum and minimum settings are adjusted, the PRESS START indicator will begin to flash. Press the START button once. After a few seconds, the

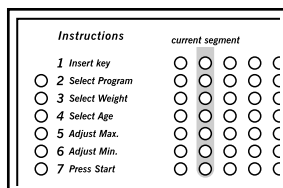

walking belt will begin to move. Hold the handrails and begin walking.

Refer to the program display. Each program is divided into one-minute segments. The Incline, Speed 1, and Speed 2 programs have twenty segments; the Speed 3 program has thirty segments.

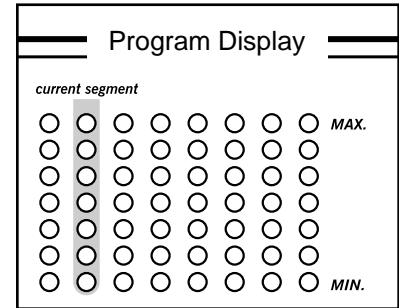

One incline or speed setting is programmed for each segment. The incline or speed setting of the first segment is shown in the CURRENT SEGMENT column. The settings of the next six segments are shown in the six columns to the right.

When the first one-minute segment of the program is completed, all settings shown in the program display will move one column to the left. The setting of the second segment will then be shown in the CURRENT SEGMENT column, and the incline or speed of the treadmill will change accordingly.

If you selected the Incline program, the speed of the walking belt can be changed at any time with the SPEED buttons. If you selected the Speed 1, Speed 2, or Speed 3 program, the incline of the treadmill can be changed with the INCLINE buttons.

The program will continue until the setting of the last segment is shown in the CURRENT SEGMENT column and no time remains in the TIME display. The walking belt will then slow to a stop.

Note: If the program is too easy or too difficult, the setting shown in the CURRENT SEGMENT column can be adjusted with the SPEED or INCLINE buttons. To pause the program temporarily, press the STOP button once. All displays will pause and the TIME display will begin to flash. To restart the program, press the START button. To stop the program before the program is completed, hold down the STOP button for two seconds. The console will then be in the same state as if the key had just been inserted.

7 Follow your progress with the LED displays.

See step 6 on page 10. Note: The TIME display will count down the time remaining in the program.

8 When you are finished exercising, stop the walking belt and remove the key.

See step 7 on page 11.

HOW TO PROGRAM THE LEARNED 1 AND LEARNED 2 PROGRAMS

The Learned 1 and Learned 2 programs are workout programs that you create. Both programs are stored in the console's memory, and can be changed as many times as desired. The programs control both the speed and incline of the treadmill.

1 Insert the key fully into the console.

See HOW TO TURN ON THE POWER on page 9.

2 Select the Learned 1 or Learned 2 program.

To select the Learned 1 or Learned 2 program, the SELECT PROGRAM indicator must be flashing. If necessary, hold down the STOP button until the SELECT PROGRAM indicator is flashing. Next, press the SELECT Δ or ∇ button repeatedly until the LEARNED 1 or LEARNED 2 indicator is flashing. Then, press the ENTER button.

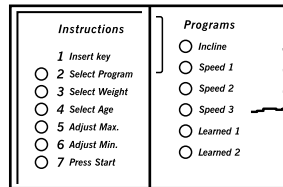

Refer to the upper right corner of the console. An "L1" or "L2" will appear in the program display.

3 Enter your weight if desired.

After a program is selected, the SELECT WEIGHT indicator and the current weight setting will begin to flash. Although it is not necessary to enter your weight to use a program, the CALORIES/FAT CALORIES display will be more accurate if your weight is entered.

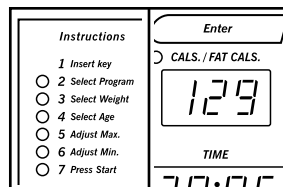

If you do not want to enter your weight, press the ENTER button and go to step 4. If you want to enter your weight, press the SELECT buttons. When the correct weight is shown, press the ENTER button.

4 Press the START button.

After you have entered your weight, the PRESS START indicator will begin to flash. Press the START button once. After a few seconds, the walking belt will begin to move. Hold the handrail and begin walking.

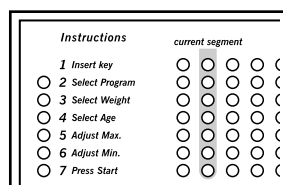

5 Press the LEARN button and program the desired speed and incline settings.

When the LEARN button is pressed, the LEARNED 1 or LEARNED 2 indicator will begin to flash. **Speed and incline settings can be programmed only when the LEARNED 1 or LEARNED 2 indicator is flashing.**

Refer to the program display. Each program is divided into one-minute segments. One speed setting and one incline setting can be programmed for each segment.

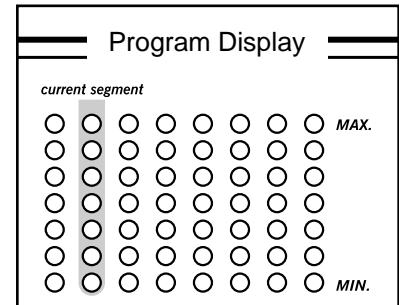

The speed setting of the first segment is shown in the CURRENT SEGMENT column. (The incline settings are not shown in the program display.) To program the desired speed and incline settings for the first segment, simply adjust the speed and incline to the desired levels by pressing the SPEED and INCLINE buttons. Every few times that the SPEED Δ or ∇ button is pressed, an additional indicator will light or darken in the CURRENT SEGMENT column.

When the first one-minute segment of the program is completed, the current speed setting and the current incline setting will be stored in memory. All settings shown in the program display will then move one column to the left, and the speed setting of the second segment will be shown in the CURRENT SEGMENT column. Program the desired speed and incline settings for the second segment as described above.

Repeat this procedure until you have programmed speed and incline settings for as many segments as desired. The Learned 1 and Learned 2 programs can have up to forty segments. When you are finished, hold down the STOP button until the SELECT PROGRAM indicator is flashing. The speed and incline settings you programmed and the number of segments will then be stored in memory. To use the program in the future, see HOW TO USE THE LEARNED 1 AND LEARNED 2 PROGRAMS on page 14.

Note: To pause the program temporarily while you are programming speed and incline settings, press the STOP button once. All displays will pause and the TIME display will begin to flash. To restart the program, press the START button.

HOW TO USE THE BUILT-IN TELEPHONE

The console features a built-in telephone that allows you to answer or make telephone calls without leaving the treadmill.

CAUTION: Stand on the foot rails when using the telephone. Do not use the telephone while running on the treadmill.

To make a call, lift the telephone from the console and dial the desired number. If the dialed number is busy, simply press the redial button to automatically redial the number. The telephone also features a tone/pulse switch.

The telephone can also be used to call E-Coach® for a Personal Trainer program. (See PERSONAL TRAINER PROGRAMS at the right.)

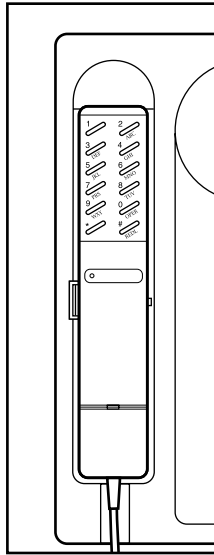

PERSONAL TRAINER PROGRAMS

In addition to the Incline program, the Speed programs, and the Learned programs, the SOFTSTRIDER features exclusive Personal Trainer programs. Simply mail the included personal profile to E-Coach®, and a personal trainer will provide you with instructions for activating a workout program designed to help you reach your specific fitness goals.

THE OPTIONAL PULSE KIT

An optional pulse kit adds even more features to the treadmill. The kit includes a state-of-the-art chest strap pulse monitor, a receiver, and a plug-in pulse module.

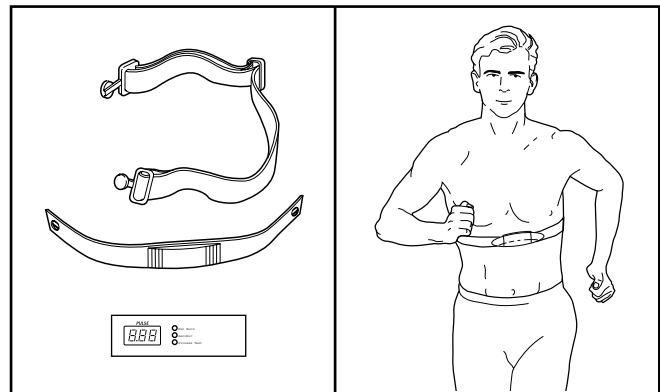

THE USER INFORMATION MODE

The console features a user information mode that keeps track of the total time and distance accumulated on the treadmill. The information mode also allows you to switch the console from miles per hour to kilometers per hour.

To select the information mode, hold down the SPEED ▽ button while inserting the key into the console.

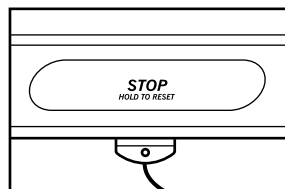

The TIME display will show the total number of hours accumulated on the treadmill. The DISTANCE/INCLINE display will show the total number of miles accumulated on the treadmill.

The console can display speed and distance in either miles or kilometers. When the information mode is selected, the SPEED display will show either an "E" (for english-miles) or an "M" (for metric-kilometers). To change the unit of measurement, press the LEARN button.

To exit the information mode, remove the key from the console.

After easy installation of the pulse kit, an LED display will track your heart rate during your workouts. The pulse kit also includes three additional workout programs: the Fat Burn program for intensive fat-burning workouts, the Aerobic program for maximum cardiovascular benefits, and the unique Fitness Test program that measures your relative fitness level. **To purchase the optional pulse kit, refer to the card accompanying the treadmill.**

HOW TO FOLD AND MOVE THE TREADMILL

HOW TO FOLD THE TREADMILL FOR STORAGE

Before folding the treadmill, unplug the power cord.
Caution: You must be able to safely lift 45 pounds (20 kg) in order to raise, lower, or move the treadmill.

1. Hold the treadmill with your hands in the locations shown at the right. **To decrease the possibility of injury, bend your legs and keep your back straight. As you raise the treadmill, make sure to lift with your legs rather than your back.** Raise the treadmill about halfway to the vertical position.
2. Move your right hand to the position shown, and hold the treadmill firmly. Using your left hand, pull the storage latch outward. Raise the treadmill until the storage latch snaps into the catch. **Make sure that the storage latch is inside the catch.**

To protect the floor or carpet from damage, place a mat under the treadmill. Keep the treadmill out of direct sunlight. Do not leave the treadmill in the storage position in temperatures above 85° Fahrenheit.

HOW TO MOVE THE TREADMILL

Before moving the treadmill, convert the treadmill to the storage position as described above. **Make sure that the storage latch is inside the catch.**

1. Hold the handrails. Place one foot on the base as shown.
2. Tilt the treadmill back until it rolls freely on the front wheels. Carefully move the treadmill to the desired location. **Never move the treadmill without tipping it back, or the base pads may come off. To reduce the risk of injury, use extreme caution while moving the treadmill. Do not attempt to move the treadmill over an uneven surface.**
3. Place one foot on the base, and carefully lower the treadmill until it is resting in the storage position.

HOW TO LOWER THE TREADMILL FOR USE

1. Hold the upper end of the treadmill with your right hand as shown. Using your left hand, pull the storage latch outward. Pivot the treadmill until the storage latch is out of the catch.
2. See the drawing at the top of the page. Hold the treadmill firmly with both hands, and lower the treadmill to the floor. **To decrease the possibility of injury, bend your legs and keep your back straight.**

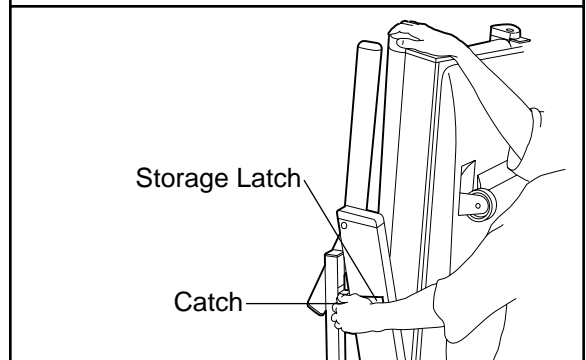
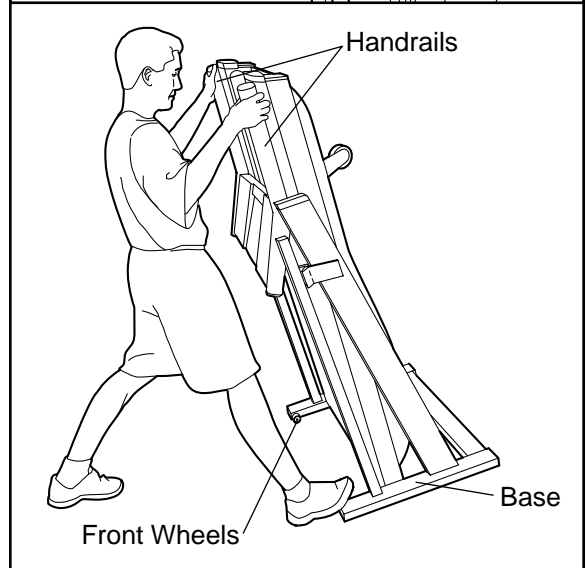
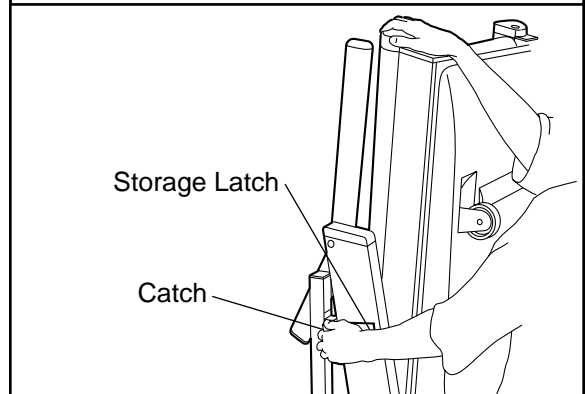
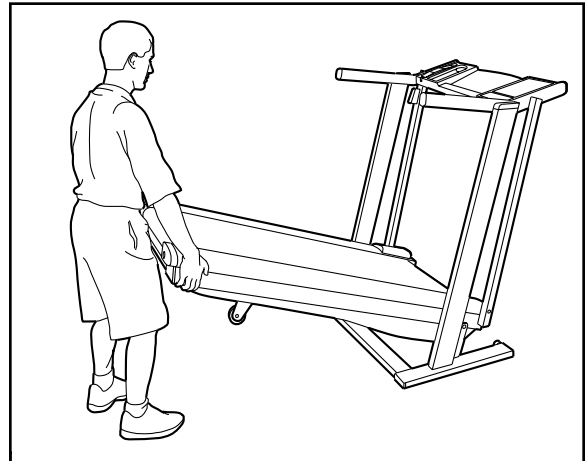

TROUBLE-SHOOTING

Most treadmill problems can be solved by following the steps below. Find the symptom that applies, and follow the steps listed. If further assistance is needed, please call our Customer Service Department toll-free at 1-800-999-3756, Monday through Friday, 6 a.m. until 6 p.m. Mountain Time (excluding holidays).

1. SYMPTOM: THE POWER DOES NOT TURN ON

- Make sure that the power cord is plugged into a surge protector, and that the surge protector is plugged into a properly grounded outlet. (See HOW TO PLUG IN THE POWER CORD on page 7.) Use only a UL-listed surge protector, rated at 15 amps, with a 14-gauge cord of five feet or less in length.
- After the power cord has been plugged in, make sure that the key is fully inserted into the console. (See HOW TO TURN ON THE POWER on page 9.)
- Check the circuit breaker located on the treadmill near the power cord. If the switch protrudes as shown, the circuit breaker has tripped. To reset the circuit breaker, wait for five minutes and then press the switch back in.
- Check the on/off switch located at the front of the treadmill near the power cord. The switch must be in the "on" position.

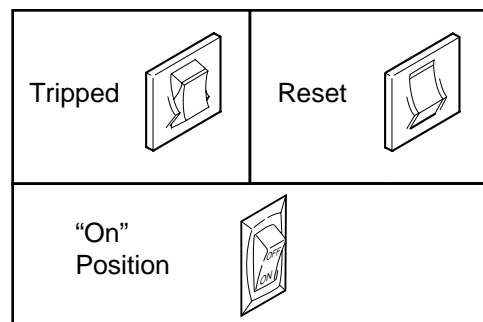

2. SYMPTOM: THE POWER TURNS OFF DURING USE

- Check the circuit breaker located on the treadmill frame near the power cord (see 1. c. above). If the circuit breaker has tripped, wait for five minutes and then press the switch back in.
- Make sure that the power cord is plugged in.
- Remove the key from the console. Reinsert the key fully into the console. (See HOW TO TURN ON THE POWER on page 9.)
- Check to make sure that the on/off switch is in the "on" position. (See 1. d. above.)
- If the treadmill still will not run, please call our Customer Service Department, toll-free.

3. SYMPTOM: BUBBLES FORM IN THE WALKING BELT

- Due to variations in humidity and temperature, there is a possibility that bubbles may form in the walking belt. Although the bubbles will disappear with time, you may unplug the power cord, carefully insert a needle into the bubbles, and push the air out of the bubbles.

4. SYMPTOM: THE WALKING BELT NEEDS TO BE CLEANED

- Use a color-fast upholstery cleaner to clean the walking belt. Test the cleaner on a small area before cleaning the entire belt.

5. SYMPTOM: THE WALKING BELT SLOWS WHEN WALKED ON

- Use only a UL-listed surge protector, rated at 15 amps, with a 14-gauge cord of five feet or less in length.
- If the walking belt still slows when walked on, please call our Customer Service Department, toll-free.

6. SYMPTOM: THE TREADMILL SITS UNEVENLY ON THE FLOOR

- Make sure that the five base pads are attached to the treadmill. See assembly step 2 on page 5.

7. SYMPTOM: THE WALKING BELT IS OFF-CENTER WHEN WALKED ON

- a. If the walking belt has shifted to the left, first remove the key and **UNPLUG THE POWER CORD**. Using the 3/16" end of the allen wrench, turn the left rear roller adjustment bolt clockwise 1/4 of a turn. Plug in the power cord, insert the key and run the treadmill for a few minutes. Repeat until the walking belt is centered.
- b. If the walking belt has shifted to the right, first remove the key and **UNPLUG THE POWER CORD**. Using the 3/16" end of the allen wrench, turn the left rear roller adjustment bolt counter-clockwise 1/4 of a turn. Plug in the power cord, insert the key and run the treadmill for a few minutes. Repeat until the walking belt is centered.

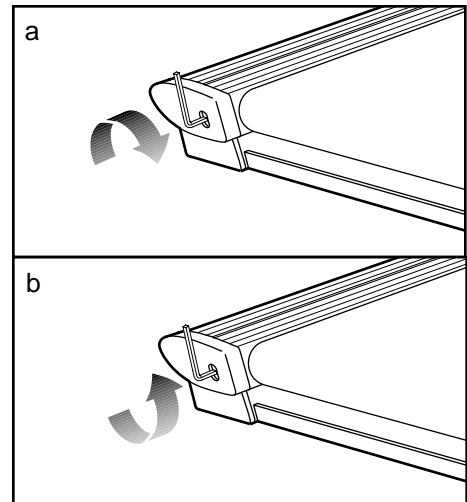

8. SYMPTOM: AN ERROR CODE (“E1,” “E2,” “E3,” OR “E4”) APPEARS IN THE SPEED DISPLAY

- a. Error code “E1” may appear in the SPEED display if the console receives no speed signal while the incline is being changed. If this occurs, remove the key, wait for ten seconds, and then reinsert it. If the error code appears again, call our Customer Service Department. **Do not operate the treadmill until the problem is corrected.**
- b. Error code “E2” may appear in the SPEED display if the console receives no speed signal when the speed setting is increased. If this occurs, remove the key, wait for ten seconds, and then reinsert it. If the error code appears again, call our Customer Service Department. **Do not operate the treadmill until the problem is corrected.**
- c. Error code “E3” may appear in the SPEED display if the actual speed of the walking belt remains two miles per hour or more above the selected speed setting. If this occurs, remove the key, wait for ten seconds, and then reinsert it. If the error code appears again, call our Customer Service Department. **Do not operate the treadmill until the problem is corrected.**
- d. Error code “E4” may appear in the SPEED display if the walking belt is moving at slow speed and there is excessive stress on the motor. If this occurs, remove the key, wait for ten seconds, and then reinsert it. If you weight over 200 pounds, it may also be helpful to increase the incline of the treadmill. If the error code appears again, call our Customer Service Department. **Do not operate the treadmill until the problem is corrected.**

CONDITIONING GUIDELINES

⚠ WARNING: Before beginning this or any exercise program, consult your physician. This is especially important for individuals over the age of 35 or individuals with pre-existing health problems.

The following basic guidelines will help you to plan your exercise program. Be sure to view the included workout video for more information.

EXERCISE INTENSITY

Whether you want to burn fat, strengthen your cardiovascular system, or tone your upper body, you can tailor your exercise for your specific goals. One of the keys to achieving the desired results is to exercise with the proper intensity. As you exercise, your heart rate should be kept at a level between 70% and 85% of your maximum possible heart rate. This is known as your training zone. You can find your training zone in the table at the top of the next page. Training zones are listed according to age and physical condition.

AGE	TRAINING ZONE (Beats/Min.)	
	Unconditioned	Conditioned
20	138-167	133-162
25	136-166	132-160
30	135-164	130-158
35	134-162	129-156
40	132-161	127-155
45	131-159	125-153
50	129-156	124-150
55	127-155	122-149
60	126-153	121-147
65	125-151	119-145
70	123-150	118-144
75	122-147	117-142
80	120-146	115-140

To measure your heart rate, stop exercising and place two fingers on your wrist as shown. Take a six-second heartbeat count, and multiply the result by ten to find your heart rate. For example, if your six-second heartbeat count is 12, your heart rate is 120 beats per second.

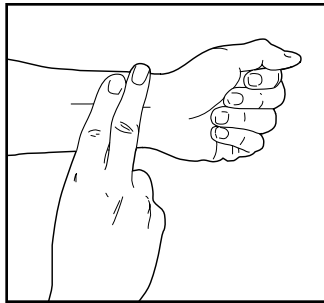

Burning Fat

To burn fat effectively, you must exercise at a relatively low intensity level for a sustained period of time. During the first few minutes of exercise, your body uses easily accessible carbohydrate calories for energy. Only after the first few minutes of exercise does your body begin to use stored fat calories for energy. If your goal is to burn fat, keep your heart rate near the low end of your training zone as you exercise.

Aerobic Exercise

If your goal is to strengthen your cardiovascular system, your exercise must be “aerobic.” Aerobic exercise is activity that requires large amounts of oxygen for prolonged periods of time. This increases the demand on the heart to pump blood to the muscles, and on the lungs to oxygenate the blood. For aerobic exercise, keep your heart rate near the middle of your training zone during exercise.

Toning Your Upper Body

The SOFTSTRIDER™ includes wrist weights that let you add upper body exercise to your workouts. The included workout video demonstrates several exercises that can be performed with weights.

⚠ WARNING: Do not perform advanced exercises with weights at speeds higher than a walk. Using weights and not holding the handrails may compromise your ability to maintain your balance. Advanced exercises using weights should be attempted only by experienced users.

WORKOUT GUIDELINES

Each workout should include three parts: (1) a warm-up, (2) training zone exercise, and (3) a cool-down.

- Begin each workout with five to ten minutes of stretching and light exercise to warm up. A proper warm-up increases your body temperature, heart rate, and circulation in preparation for strenuous exercise.
- After warming up, increase the intensity of your exercise until your heart rate is in your training zone for 20 to 30 minutes. Breathe regularly and deeply as you exercise—never hold your breath.
- End each workout with five to ten minutes of stretching to cool down. This will develop muscle flexibility and will help to prevent post-exercise problems.

To maintain or improve your condition, complete three workouts each week, with at least one day of rest between workouts. After a few months, you may complete up to five workouts each week if desired.

REMOVE THIS EXPLODED DRAWING AND PART LIST FROM THE MANUAL

Save this EXPLODED DRAWING and PART LIST for future reference.

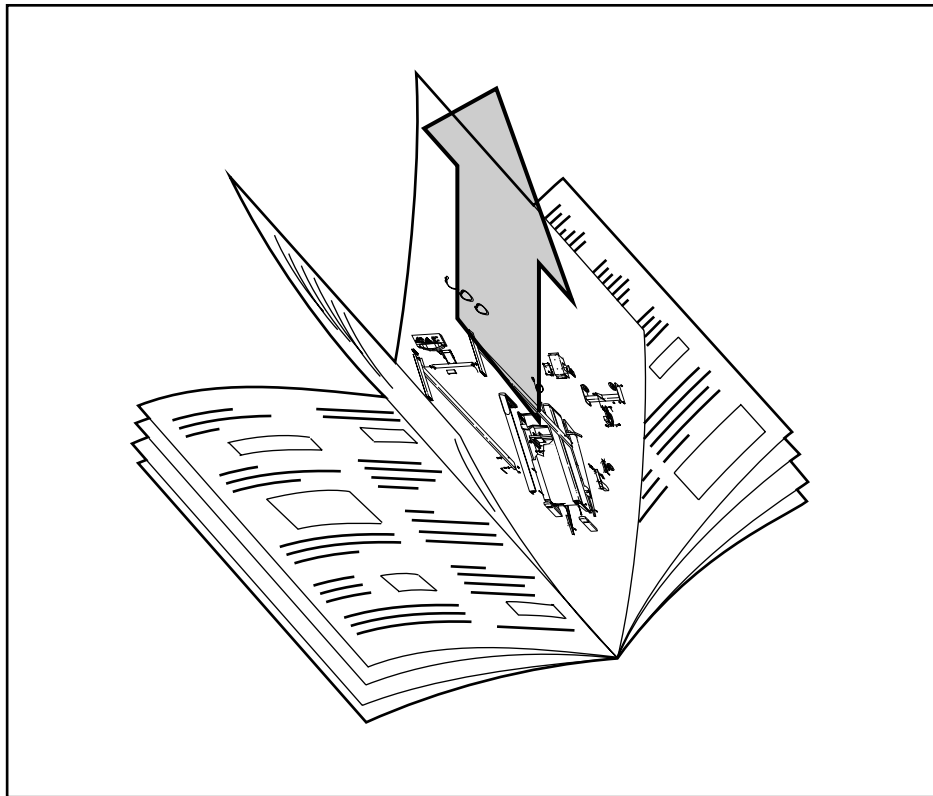

Note: Specifications are subject to change without notice. For information about ordering replacement parts, see the back cover of the User's Manual.

PART LIST—Model No. DRTL25060

R0297B

Key No.	Qty.	Description	Key No.	Qty.	Description
1	1	Left Link Arm	65	1	Power Cord
2	1	Right Link Arm	66	1	Grommet
3	2	Incline Motor Bolt	67	1	Circuit Breaker
4	1	Motor Tension Washer	68	1	Electronics Bracket
5	1	Motor Tension Star Washer	69	1	Controller
6	1	Motor Tension Nut	70	1	Power Supply w/Clips
7	4	Pulley Cover Screw	71	1	Choke
8	1	Left Pivot Bolt	72	1	Lower Saddle Bracket
9	4	Link Arm Bolts	73	1	Incline Leg
10	5	Spacer	74	1	Telephone
11	2	Upright Bolt	75*	1	Pulse Kit (Optional—see page 15)
12	21	Console Screw/Latch Screw	76	1	Electronics Insert
13	1	Motor-Controller Wire	77	1	Console
14	3	Book Rack Screw	78	1	Console Plate
15	1	Speed Disk	79	1	Right Handlebar
16	22	Screw	80	1	Left Handlebar
17	4	Plastic Stand-Off	81	1	Base
18	4	Cage Nut	82	1	Belly Pan
19	4	Lower Link Arm Nut/Motor Pivot Nut	83	1	Frame
20	2	Link Arm Spacer	84	1	Left Foot Rail
21	1	Incline Motor Spacer	85	1	Right Foot Rail
22	2	Incline Leg Bolt	86	1	Rear Roller
23	2	Wheel Bolt	87	1	Front Roller/Pulley
24	6	Wheel Nut	88	1	Optic Bracket Nut
25	2	Incline Leg Spacer	89	1	Walking Board
26	5	Adjustment Washer	90	1	Shock
27	1	Short Adjustment Bolt	91	1	Wire Harness
28	8	Platform Screw	92	3	Wire Harness Grommet
29	2	Saddle Bracket Bolt	93	1	Walking Belt
30	23	Belly Pan Screw	94	1	Allen Wrench
31	1	Console Wire Harness	95	1	Adhesive Clip
32	1	Incline Motor	96	1	Releaseable Wire Tie
33	1	Tension Spring	97	1	Console Shield
34	1	Spring Sleeve	98	3	4" Cable Tie
35	1	Roller Tension Nut	99	3	8" Cable Tie
36	1	Motor Pivot Bolt	100	2	Belt Guide
37	1	Pulley Cover	101	1	Key/Clip
38	1	Book Rack	102	2	Optic Switch
39	1	Book Rack Cover	103	1	Personal Fitness Journal
40	1	Storage Latch Catch	104	2	Photo Wire
41	1	Storage Latch	105	1	Long Adjustment Bolt
42	2	Link Arm Endcap	106	1	On/Off Switch
43	2	Upright Endcap	107	1	Front Roller Adjustment Bolt
44	2	Base Wheel Bolt	108	1	Optic Speed Bracket
45	1	Incline Pivot Bolt	109	6	Base Pad
46	2	Lower Link Arm Bolt	110	2	Wrist Weight
47	2	Optic Switch Screw	111	1	Workout Video
48	2	Optic Switch Star Washer	112	1	Latch Decal
49	2	Optic Switch Nut	113	1	Bumper
50	4	Handlebar Endcap	114	1	Bumper Screw
51	4	Base Endcap	115	1	Console Warning Decal
52	1	Incline Disk	116	1	Small Console Cover
53	1	Belly Pan Wire Harness	117	1	Motor Tension Bolt
54	1	Incline Extension	#	1	8" White Wire, Male/Female
55	2	Base Wheel	#	1	8" White Wire, 2 Female
56	2	Incline Wheel	#	1	8" Blue Wire, 2 Female
57	1	Right Rear Endcap	#	1	4" Blue Wire, 2 Female
58	1	Left Rear Endcap	#	1	8" Red Wire, Male/Female
59	1	Right Front Endcap	#	1	4" Black Wire, 2 Female
60	1	Left Front Endcap	#	1	8" Green Ground Wire
61*	1	Motor/Pulley/Flywheel/Fan	#	1	Personal Profile
62	1	Motor	#	1	User's Manual
63	1	Pulley/Flywheel/Fan			
64	1	Motor Belt			

* Includes all parts shown in the box

These parts are not illustrated

EXPLODED DRAWING—Model No. DRTL25060

R0297B

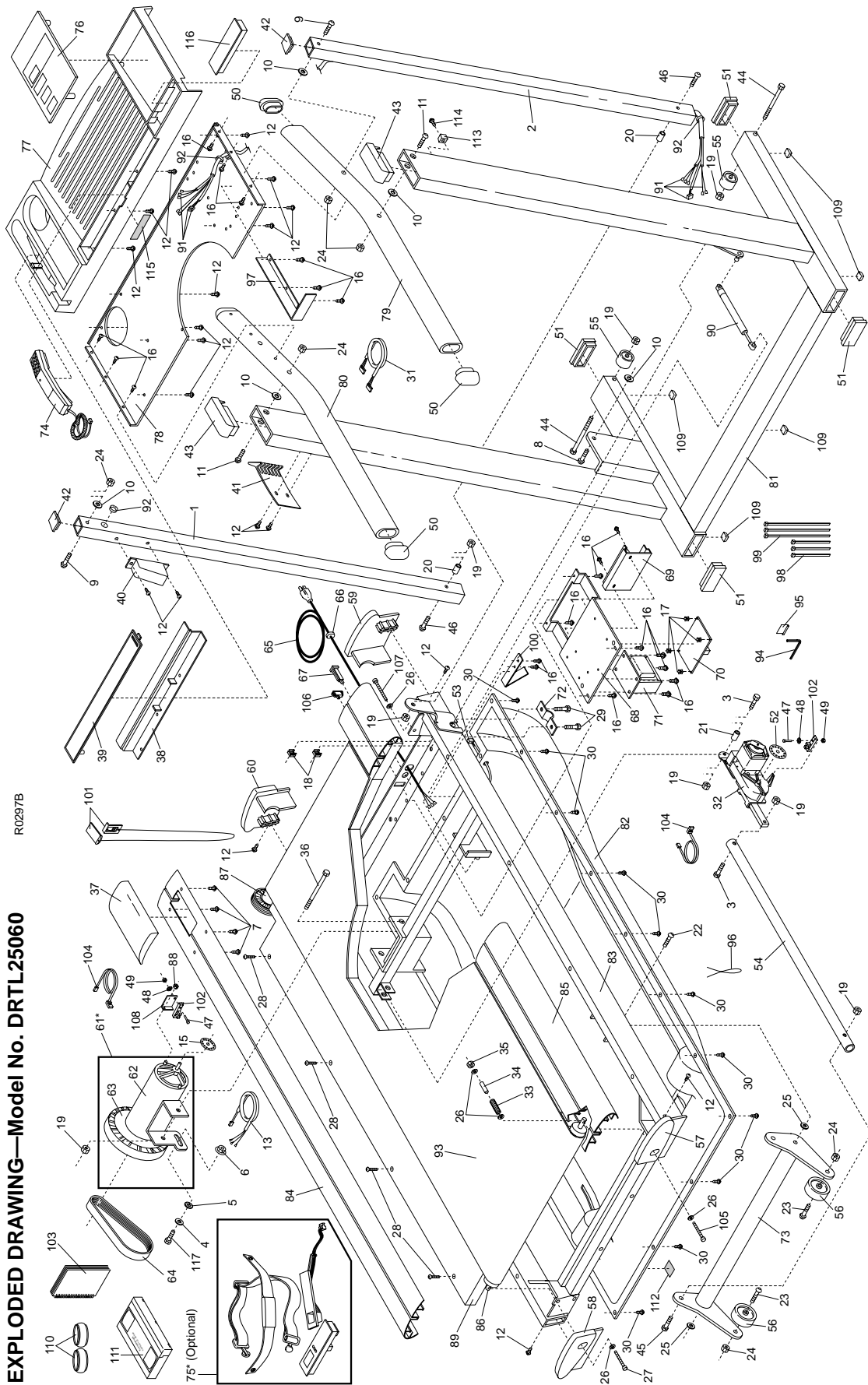

ORDERING REPLACEMENT PARTS

To order replacement parts, call our Customer Service Department toll-free at 1-800-999-3756, Monday through Friday, 6 a.m. until 6 p.m. Mountain Time (excluding holidays). Before calling, please note the following information:

- The MODEL NUMBER of the product (DRTL25060).
- The NAME of the product (HealthRider® SOFTSTRIDER™ treadmill).
- The SERIAL NUMBER of the product (see the front cover of this manual).
- The KEY NUMBER and DESCRIPTION of the replacement part(s) (see the EXPLODED DRAWING and PART LIST attached to the center of this manual).

LIMITED WARRANTY

HealthRider Corp., Inc. (HealthRider), warrants this product to be free from defects in workmanship and material, under normal use and service conditions, for a period of ninety (90) days from the date of purchase. This warranty extends only to the original purchaser. HealthRider's obligation under this warranty is limited to replacing or repairing, at HealthRider's option, the product at one of its authorized service centers. All products for which warranty claim is made must be received by HealthRider at one of its authorized service centers with all freight and other transportation charges prepaid, accompanied by sufficient proof of purchase. All returns must be pre-authorized by HealthRider. This warranty does not extend to any product or damage to a product caused by or attributable to freight damage, abuse, misuse, improper or abnormal usage or repairs not provided by an HealthRider authorized service center, to products used for commercial or rental purposes, or to products used as store display models. No other warranty beyond that specifically set forth above is authorized by HealthRider.

HealthRider is not responsible or liable for indirect, special or consequential damages arising out of or in connection with the use or performance of the product or damages with respect to any economic loss, loss of property, loss of revenues or profits, loss of enjoyment or use, costs of removal, installation or other consequential damages of whatsoever nature. Some states do not allow the exclusion or limitation of incidental or consequential damages. Accordingly, the above limitation may not apply to you.

The warranty extended hereunder is in lieu of any and all other warranties and any implied warranties of merchantability or fitness for a particular purpose is limited in its scope and duration to the terms set forth herein. Some states do not allow limitations on how long an implied warranty lasts. Accordingly, the above limitation may not apply to you.

This warranty gives you specific legal rights. You may also have other rights which vary from state to state.

HealthRider Corp. 1500 S. 1000 W., LOGAN, UT 84321-9813

Free Manuals Download Website

<http://myh66.com>

<http://usermanuals.us>

<http://www.somanuals.com>

<http://www.4manuals.cc>

<http://www.manual-lib.com>

<http://www.404manual.com>

<http://www.luxmanual.com>

<http://aubethermostatmanual.com>

Golf course search by state

<http://golfingnear.com>

Email search by domain

<http://emailbydomain.com>

Auto manuals search

<http://auto.somanuals.com>

TV manuals search

<http://tv.somanuals.com>