

Model No. HRTL07120

Serial No. _____

Write the serial number in the space above for future reference.

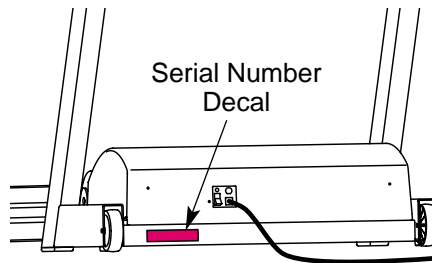

QUESTIONS?

If you have questions, or if there are missing parts, we will guarantee complete satisfaction through direct assistance from our factory.

TO AVOID DELAYS, PLEASE CALL DIRECT TO OUR TOLL-FREE CUSTOMER HOT LINE. The trained technicians on our customer hot line will provide immediate assistance, free of charge.

CUSTOMER HOT LINE:

1-800-999-3756

Mon.-Fri., 6 a.m.-6 p.m. MST

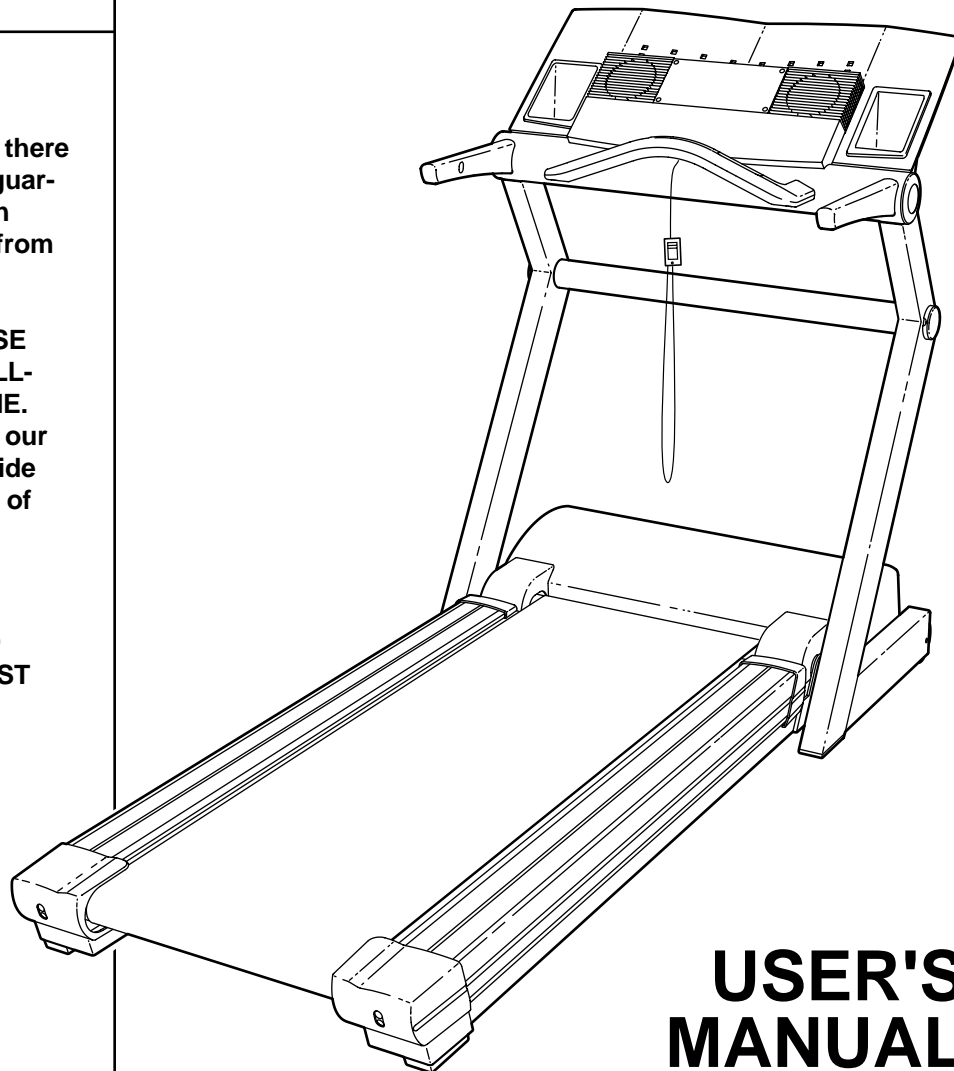

USER'S MANUAL

CAUTION

Read all precautions and instructions in this manual before using this equipment. Save this manual for future reference.



Visit our website at

www.healthrider.com

*new products, prizes,
fitness tips, and much more!*



TABLE OF CONTENTS

IMPORTANT PRECAUTIONS3
BEFORE YOU BEGIN5
ASSEMBLY6
HOW TO USE THE CHEST PULSE SENSOR8
TREADMILL OPERATION9
HOW TO FOLD AND MOVE THE TREADMILL24
TROUBLESHOOTING26
EXERCISE GUIDELINES28
PART LIST30
HOW TO ORDER REPLACEMENT PARTS31
LIMITED WARRANTY	Back Cover

Note: An EXPLODED DRAWING is attached in the center of this manual.

IMPORTANT PRECAUTIONS

⚠ WARNING: To reduce the risk of burns, fire, electric shock, or injury to persons, read the following important precautions and information before operating the treadmill.

1. It is the responsibility of the owner to ensure that all users of this treadmill are adequately informed of all warnings and precautions.
2. Use the treadmill only as described in this manual.
3. Place the treadmill on a level surface, with at least eight feet of clearance behind it and two feet on each side. Do not place the treadmill on any surface that blocks air openings. To protect the floor or carpet from damage, place a mat under the treadmill.
4. Keep the treadmill indoors, away from moisture and dust. Do not put the treadmill in a garage or covered patio, or near water.
5. Do not operate the treadmill where aerosol products are used or oxygen is administered.
6. Keep children under the age of 12 and pets away from the treadmill at all times.
7. The treadmill should not be used by persons weighing more than 250 pounds. Never allow more than one person on the treadmill at a time.
8. Wear appropriate exercise clothes when using the treadmill. Do not wear loose clothes that could become caught in the treadmill. Athletic support clothes are recommended for both men and women. *Always wear athletic shoes. Never use the treadmill with bare feet, wearing only stockings, or in sandals.*
9. When connecting the power cord (see page 9), plug the power cord into a surge suppressor (not included) and plug the surge suppressor into a grounded circuit capable of carrying 15 or more amps. No other appliance should be on the same circuit. Do not use an extension cord.
10. Use only a single-outlet surge suppressor that meets all of the specifications described on page 9. To purchase a surge suppressor, see your local HealthRider dealer or call 1-800-806-3651 and order part number 146148.
11. Failure to use a properly functioning surge suppressor could result in damage to the control system of the treadmill. If the control system is damaged, the walking belt may change speed or stop unexpectedly, which may result in a fall and serious injury.
12. Keep the power cord and the surge suppressor away from heated surfaces.
13. Never move the walking belt while the power is turned off. Do not operate the treadmill if the power cord or plug is damaged, or if the treadmill is not working properly. (See **BEFORE YOU BEGIN** on page 5 if the treadmill is not working properly.)
14. Never start the treadmill while you are standing on the walking belt. Always hold the handrails while using the treadmill.
15. The treadmill is capable of high speeds. Adjust the speed in small increments to avoid sudden jumps in speed.
16. The pulse sensors are not medical devices. Various factors, including the user's movement, may affect the accuracy of heart rate readings. The pulse sensors are intended only as exercise aids in determining heart rate trends in general.
17. Never leave the treadmill unattended while it is running. Always remove the key, unplug the power cord, and move the on/off switch to the off position when the treadmill is not in use. (See the drawing on page 5 for the location of the on/off switch.)
18. Do not attempt to raise, lower, or move the treadmill until it is properly assembled. (See **ASSEMBLY** on page 6, and **HOW TO FOLD AND MOVE THE TREADMILL** on page 24.) You must be able to safely lift 45 pounds (20 kg) to raise, lower, or move the treadmill.
19. When folding or moving the treadmill, make sure that the storage latch is fully closed.

20. When using iFIT.com CD's and videos, an electronic "chirping" sound will alert you when the speed and/or incline of the treadmill is about to change. Always listen for the "chirp" and be prepared for speed and/or incline changes. In some instances, the speed and/or incline may change before the personal trainer describes the change.

21. When using iFIT.com CD's and videos, you can manually override the speed and incline settings at any time by pressing the speed and incline buttons. However, when the next "chirp" is heard, the speed and/or incline will change to the next settings of the CD or video program.

22. Always remove iFIT.com CD's and videos from your CD player or VCR when you are not using them.

23. Inspect and properly tighten all parts of the treadmill every three months.

24. Never drop or insert any object into any opening.

25. **DANGER:** Always unplug the power cord immediately after use, before cleaning the treadmill, and before performing the maintenance and adjustment procedures described in this manual. Never remove the motor hood unless instructed to do so by an authorized service representative. Servicing other than the procedures in this manual should be performed by an authorized service representative only.

26. The treadmill is intended for in-home use only. Do not use the treadmill in any commercial, rental, or institutional setting.

⚠ WARNING: Before beginning this or any exercise program, consult your physician. This is especially important for persons over the age of 35 or persons with pre-existing health problems. Read all instructions before using. ICON assumes no responsibility for personal injury or property damage sustained by or through the use of this product.

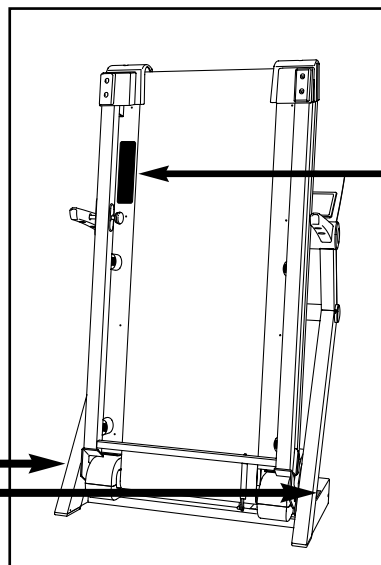

SAVE THESE INSTRUCTIONS

The decals shown below have been placed on your treadmill. If a decal is missing, or if it is not legible, please call our Customer Service Department toll-free at 1-800-999-3756 to order a free replacement decal. Apply the decal in the location shown. Note: The decals are not shown at actual size.



⚠ WARNING:

Protect yourself and others from risk of serious injury. Read the user's manual and :

-  • Stand only on the side rails when starting or stopping treadmill.
- Change speed in small increments.
- Hold handrails to prevent falling, and always wear the safety clip while operating treadmill.
- Stop if you feel faint, dizzy, or short of breath.
- Fully engage storage latch before treadmill is moved or stored.
- Reduce incline to its lowest level before folding treadmill into storage position.
-  • Never allow children on or around treadmill.
- Remove key when not in use.
-  • Keep clothing, fingers, and hair away from moving belt.
- Never try to adjust or fix the belt while it is moving.
- Always wear athletic shoes while operating treadmill.

BEFORE YOU BEGIN

Congratulations for purchasing the HealthRider® R60 treadmill. The R60 treadmill offers an impressive array of features to help you achieve your fitness goals in the convenience of your home. From the advanced console to the cushioned walking platform, the R60 treadmill is designed to make each workout more effective and enjoyable. And when you're not exercising, the treadmill can be folded away, taking less than half the floor space of conventional treadmills.

For your benefit, read this manual carefully before using the treadmill. If you have additional questions,

please call our Customer Service Department toll-free at 1-800-999-3756, Monday through Friday, 6 a.m. until 6 p.m. Mountain Time (excluding holidays). To help us assist you, please note the product model number and serial number before calling. The model number is HRTL07120. The serial number can be found on a decal attached to the treadmill (see the front cover of this manual for the location).

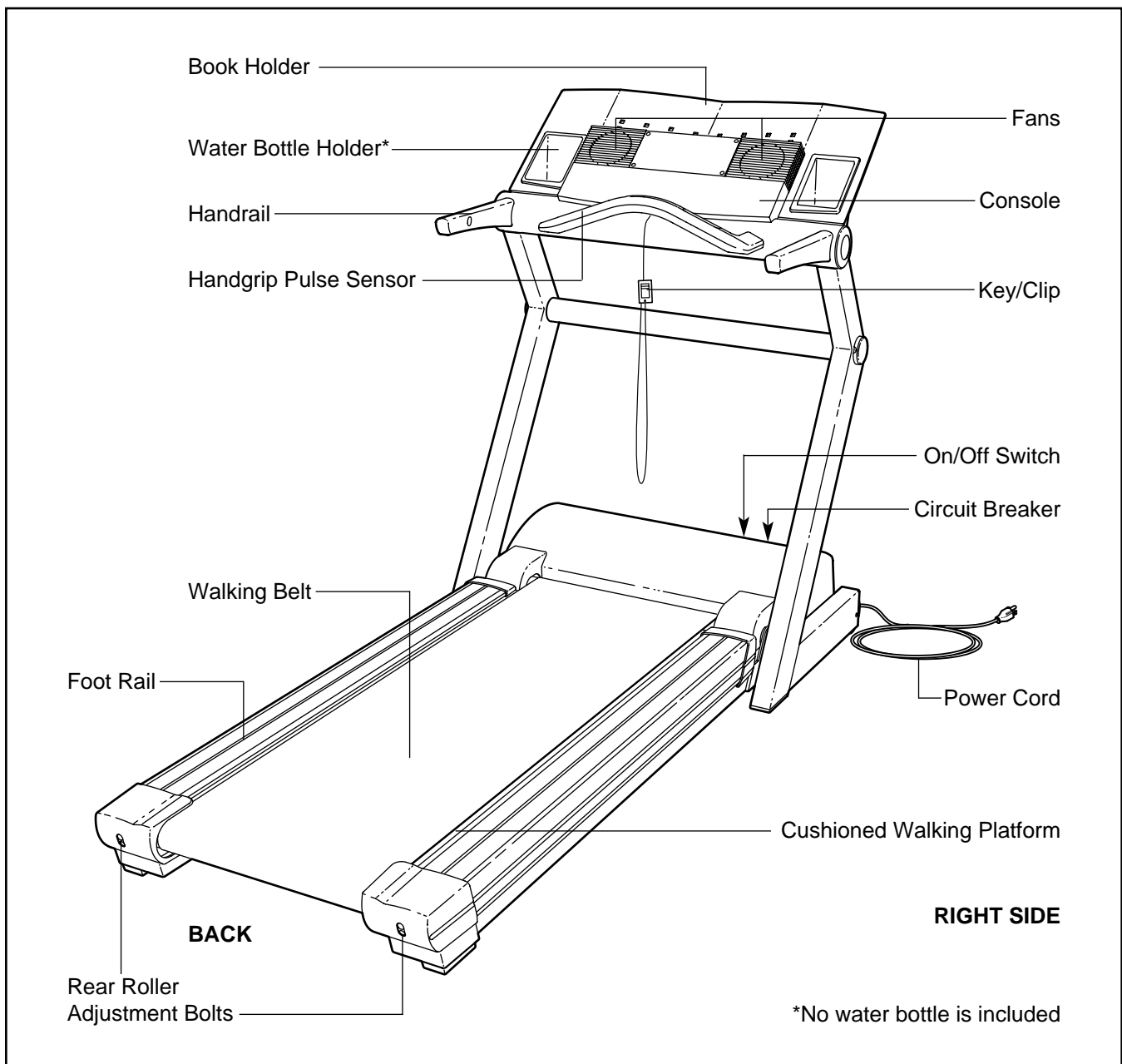

Before reading further, please familiarize yourself with the parts that are labeled in the drawing below.



ASSEMBLY

Assembly requires two people. Place the treadmill in a cleared area and remove all packing materials. Do not dispose of the packing materials until the treadmill is assembled.

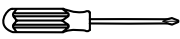
Note: The underside of the treadmill walking belt is coated with high-performance lubricant. During shipping, a small amount of lubricant may be transferred to the top of the walking belt, the sides of the walking platform, or the shipping carton. This does not affect treadmill performance. If there is lubricant on top of the walking belt or on the sides of the walking platform, wipe off the lubricant with a soft cloth and a mild, non-abrasive cleaner.

Assembly requires your own phillips screwdriver , **rubber mallet**  and **wire cutters** .

1. Cut the plastic ties (not shown) from the sides of the treadmill. **With the help of a second person**, carefully raise the Uprights (65) until the Wheels (not shown) are resting on the floor.

Hold the Book Plate (114) against the back of the Console Base (117) and the Upright (65) with the "V" shape of the Book Plate positioned as shown. Attach the Book Plate with four 3/4" Screws (40).

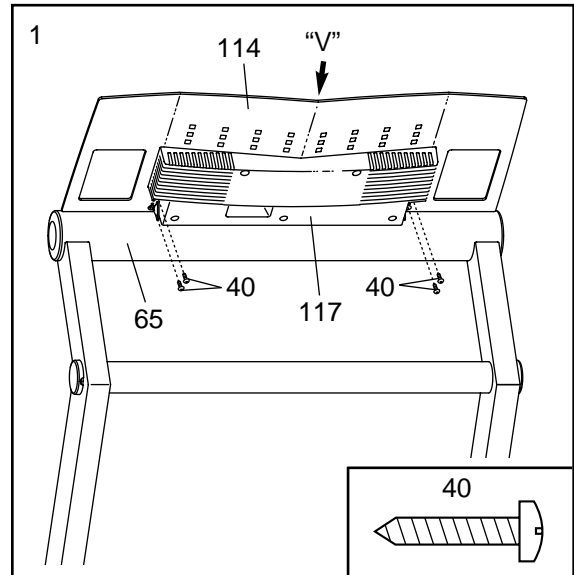

2. Insert one of the Handrail Extensions (76) into the post on the left side of the Upright (65). **Make sure that the notch in the Handrail Extension is in the position shown.** Align the holes in the Handrail Extension with the holes in the post. If necessary, use a rubber mallet to fully insert the Handrail Extension. Attach the Handrail Extension to the post with four Extension Screws (131).

Identify the Left Foam Grip (62), which has a hole in the right side. Slide the Left Foam Grip as far as possible onto the Handrail Extension (76) and the post. (Note: It may be helpful to apply soapy water to the Handrail Extension.) Press two Plastic Fasteners (75) into the bottom of the Left Foam Grip and the Handrail Extension.

Attach the other Handrail Extension and the Right Foam Grip (not shown) to the post on the right side of the Upright (65) in the same way. Note: There is not a hole in the side of the Right Foam Grip.

Identify the Left Cup Holder (128); the lower edge is narrower on the left side, as shown. Press the Left Cup Holder into the Book Plate (114). Press the Right Cup Holder (not shown) into the other side of the Book Plate.

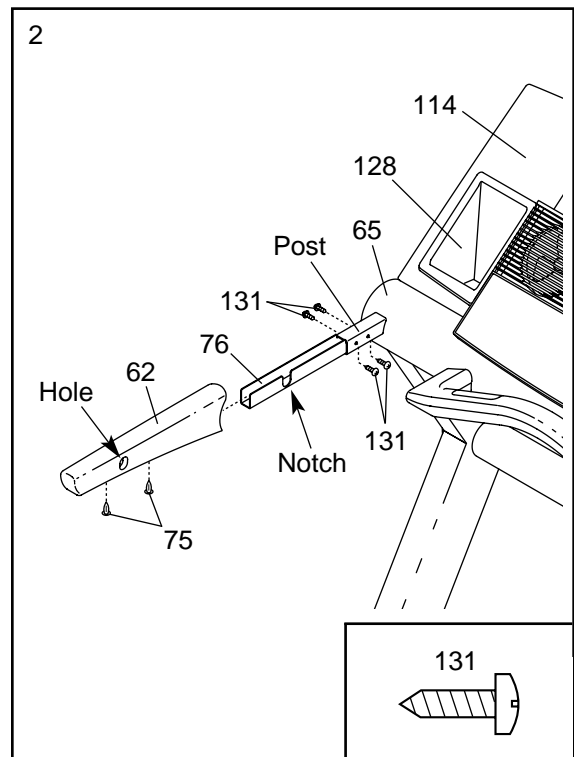

3. With the help of a second person, raise the Frame (55). Hold the Latch Housing (68) and the Latch Housing Cover (5) against the sides of the Frame (55) as shown. Loosely screw the two 1/2" Screws (132) into the Latch Housing Cover and the Latch Housing as shown. **Do not tighten the Screws yet.**

Remove the Lock Knob (67) from the Lock Pin (72). Make sure that the Lock Pin Collars (70) and the Spring (69) are on the Lock Pin. The Lock Pin Collars should be on each side of the Spring. Insert the Lock Pin into the Latch Housing (68), and tighten the Lock Knob onto it.

Align the Lock Pin (72) with the hole in the Left Foam Grip (62) by sliding the Latch Housing (68) up or down. Make sure that the Lock Pin can be inserted fully into the hole. Hold the Latch Housing in place as you tighten two 3/4" Screws (40) in the Latch Housing and the Frame (55). Tighten the 1/2" Screws (132). Note: It may be necessary to pull on the Lock Knob (67) to access and tighten the Screws.

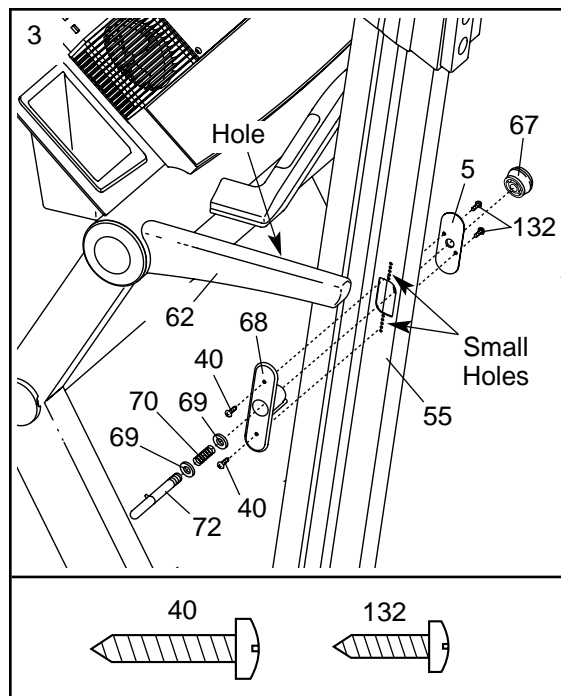

4. **Make sure that all parts are properly tightened before you use the treadmill. Place a mat beneath the treadmill to protect the floor or carpet.** For your benefit, we recommend that you familiarize yourself with the TROUBLESHOOTING section on pages 26 and 27.

HOW TO USE THE CHEST PULSE SENSOR

HOW TO PUT ON THE CHEST PULSE SENSOR

The chest pulse sensor consists of two components: the chest strap and the sensor unit (see the drawing below). Insert the tab on one end of the chest strap into one end of the sensor unit, as shown in the inset drawing. Press the end of the sensor unit under the buckle on the chest strap. The tab should be flush with the front of the sensor unit.

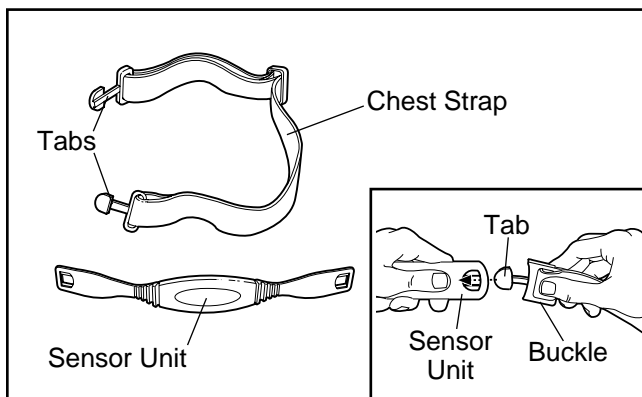

Next, wrap the chest pulse sensor around your chest and attach the other end of the chest strap to the sensor unit. Adjust the length of the chest strap, if necessary. The chest pulse sensor should be under your clothes, tight against your skin, and as high under the pectoral muscles or breasts as is comfortable. Make sure that the logo on the sensor unit is facing forward and is right-side-up.

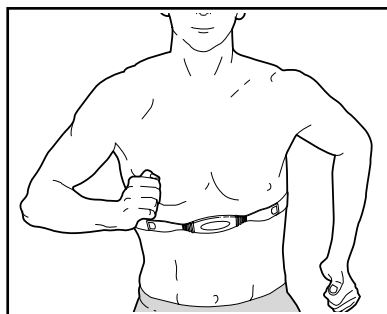

Pull the sensor unit away from your body a few inches and locate the two electrode areas on the inner side (the electrode areas are covered by shallow ridges). Using saline solution such as saliva or contact lens solution, wet both electrode areas. Return the sensor unit to a position against your chest.

CHEST PULSE SENSOR CARE AND MAINTENANCE

- Thoroughly dry the chest pulse sensor after each use. The chest pulse sensor is activated when the electrode areas are wetted and the heart rate monitor is put on; the chest pulse sensor shuts off when it is removed and the electrode areas are

dried. If the chest pulse sensor is not dried after each use, it may remain activated longer than necessary, draining the battery prematurely.

- Store the chest pulse sensor in a warm, dry place. Do not store the chest pulse sensor in a plastic bag or other container that may trap moisture.
- Do not expose the chest pulse sensor to direct sunlight for extended periods of time; do not expose it to temperatures above 122° Fahrenheit (50° Celsius) or below 14° Fahrenheit (-10° Celsius).
- Do not excessively bend or stretch the sensor unit when using or storing the chest pulse sensor.
- Clean the sensor unit using a damp cloth—never use alcohol, abrasives, or chemicals. The chest strap may be hand washed and air dried.

CHEST PULSE SENSOR TROUBLESHOOTING

The instructions on the following pages explain how the chest pulse sensor is used with the console. If the chest pulse sensor does not function properly, try the steps below.

- Make sure that you are wearing the chest pulse sensor as described at the left. Note: If the chest pulse sensor does not function when positioned as described, move it slightly lower or higher on your chest.
- Use saline solution such as saliva or contact lens solution to wet the two electrode areas on the sensor unit. If heart rate readings do not appear until you begin perspiring, re-wet the electrode areas.
- As you walk or run on the treadmill, position yourself near the center of the walking belt. **For the console to display heart rate readings, the user must be within arm's length of the console.**
- The chest pulse sensor is designed to work with people who have normal heart rhythms. Heart rate reading problems may be caused by medical conditions such as premature ventricular contractions (pvc's), tachycardia bursts, and arrhythmia.
- The operation of the chest pulse sensor can be affected by magnetic interference caused by high power lines or other sources. If it is suspected that this is a problem, try relocating the treadmill.
- The CR2032 battery may need to be replaced (see page 27).

TREADMILL OPERATION

THE PERFORMANT LUBE™ WALKING BELT

Your treadmill features a walking belt coated with PERFORMANT LUBE™, a high-performance lubricant. **IMPORTANT: Never apply silicone spray or other substances to the walking belt or the walking platform. Such substances will deteriorate the walking belt and cause excessive wear.**

HOW TO PLUG IN THE POWER CORD

⚠ DANGER: Improper connection of the equipment-grounding conductor can result in an increased risk of electric shock. Check with a qualified electrician or serviceman if you are in doubt as to whether the product is properly grounded. Do not modify the plug provided with the product—if it will not fit the outlet, have a proper outlet installed by a qualified electrician.

Your treadmill, like any other type of sophisticated electronic equipment, can be seriously damaged by sudden voltage changes in your home's power. Voltage surges, spikes, and noise interference can result from weather conditions or from other appliances being turned on or off. **To decrease the possibility of your treadmill being damaged, always use a surge suppressor with your treadmill (see drawing 1 at the right).** To purchase a surge suppressor, see your local HealthRider dealer or call 1-800-806-3651 and order part number 146148.

Use only a single-outlet surge suppressor that is UL 1449 listed as a transient voltage surge suppressor (TVSS). The surge suppressor must have a UL suppressed voltage rating of 400 volts or less and a minimum surge dissipation of 450 joules. The surge suppressor must be electrically rated for 120 volts AC and 15 amps. There must be a monitoring light on the surge suppressor to indicate whether it is functioning properly. Failure to use a properly functioning surge suppressor could result in damage to the control system of the treadmill. If the control system is damaged, the walking belt may change speed or stop unexpectedly, which may result in a fall and serious injury.

This product must be grounded. If it should malfunction or break down, grounding provides a path of least resistance for electric current to reduce the risk of electric shock. This product is equipped with a cord having

an equipment-grounding conductor and a grounding plug. **Plug the power cord into a surge suppressor, and plug the surge suppressor into an appropriate outlet that is properly installed and grounded in accordance with all local codes and ordinances. Important: The treadmill is not compatible with GFCI-equipped outlets.**

This product is for use on a nominal 120-volt circuit, and has a grounding plug that looks like the plug illustrated in drawing 1 below. A temporary adapter that looks like the adapter illustrated in drawing 2 may be used to connect the surge suppressor to a 2-pole receptacle as shown in drawing 2 if a properly grounded outlet is not available.

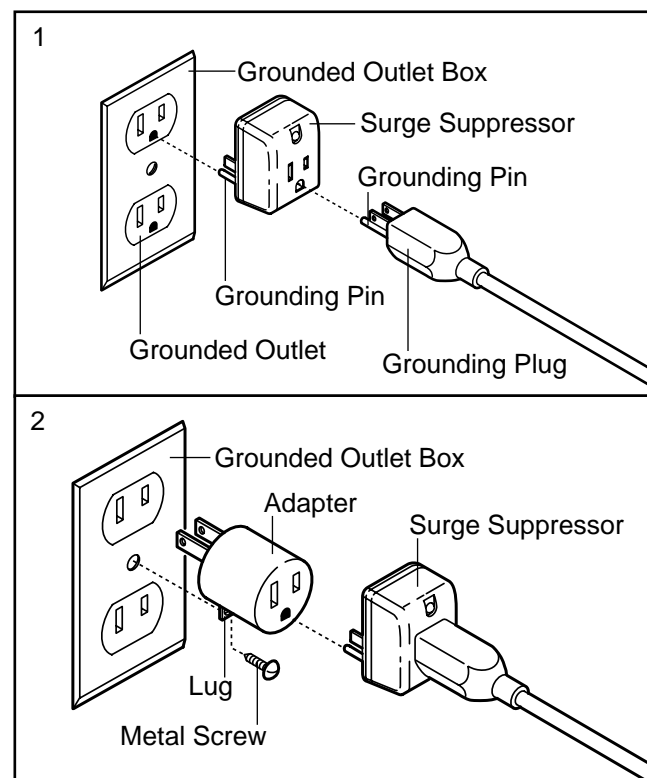

The temporary adapter should be used only until a properly grounded outlet (drawing 1) can be installed by a qualified electrician.

The green-colored rigid ear, lug, or the like extending from the adapter must be connected to a permanent ground such as a properly grounded outlet box cover. Whenever the adapter is used it must be held in place by a metal screw. **Some 2-pole receptacle outlet box covers are not grounded. Contact a qualified electrician to determine if the outlet box cover is grounded before using an adapter.**

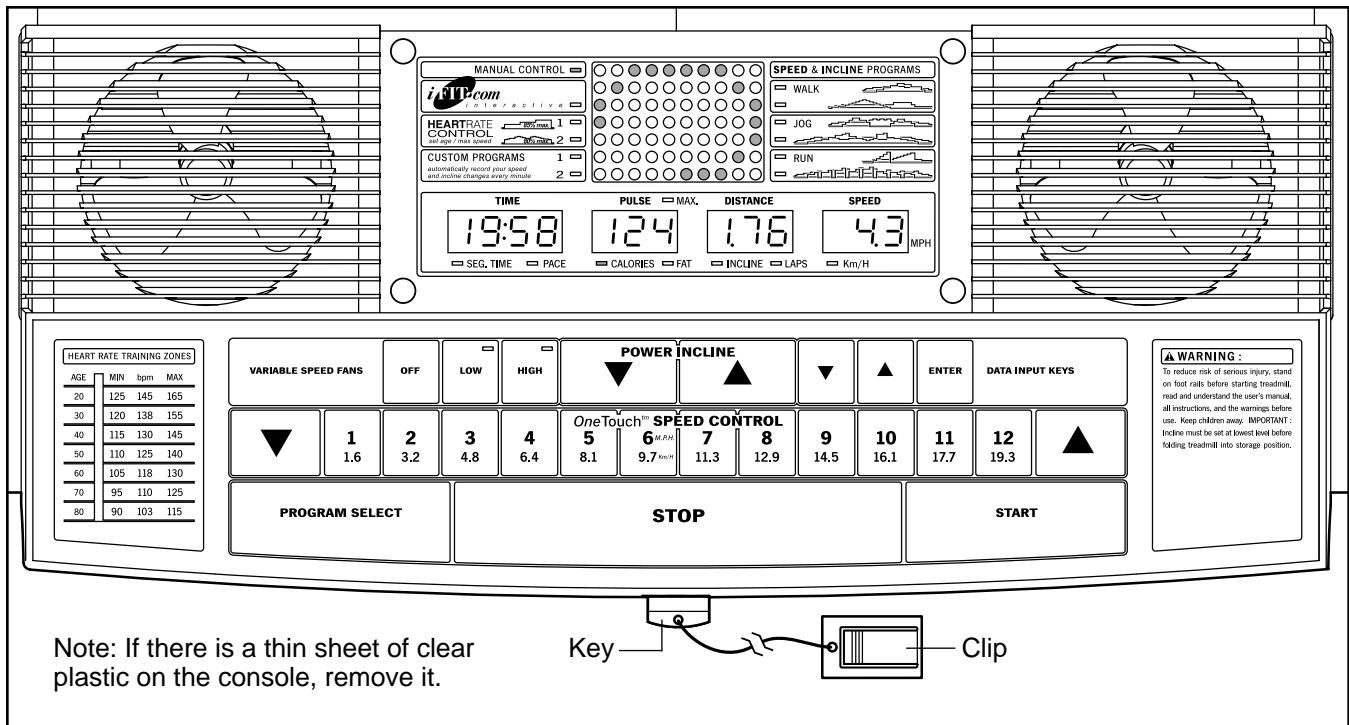

FEATURES OF THE CONSOLE

The treadmill console offers an impressive array of features designed to make your workouts more effective.

When the manual mode of the console is selected, the speed and incline of the treadmill can be changed with a touch of a button. As you exercise, the console will display instant exercise feedback. You can even measure your heart rate using the handgrip pulse sensor or the chest pulse sensor.

In addition, the console offers six preset workout programs. Each program automatically controls the speed and incline of the treadmill as it guides you through an effective workout. Two pulse programs are also offered. Each program automatically adjusts the speed and incline of the treadmill to keep your heart rate within a preset range while you exercise.

The console even allows you to create your own workout programs and save them in memory for future use.

The console also features new iFIT.com interactive technology. iFIT.com technology is like having a personal trainer right in your home. Using the included audio cable, you can connect the treadmill to your home stereo, portable stereo, or computer and play special iFIT.com CD programs (2 iFIT.com CD's are in-

cluded). iFIT.com CD programs automatically control the speed and incline of the treadmill as a personal trainer guides you through every step of your workout. High-energy music provides added motivation. Each CD features two programs designed by certified personal trainers.

In addition, you can connect the treadmill to your VCR and TV and play iFIT.com video programs (videocassettes are available separately). Video programs offer the same benefits as iFIT.com CD programs, but add the excitement of working out with a class and an instructor—the hottest new trend at health clubs.

With the treadmill connected to your computer, you can also go to our Web site at www.iFIT.com and access programs directly from the internet. Additional options are soon to be available. See www.iFIT.com for details.

To purchase iFIT.com CD's or videocassettes, call toll-free 1-800-735-0768.

To use the manual mode of the console, follow the steps beginning on page 11. **To use preset programs**, see page 13. **To use heart rate programs**, see page 14. **To create and use custom programs**, see pages 16 and 17. **To use iFIT.com CD or video programs**, see page 20. **To use iFIT.com programs directly from our Web site**, see page 22.

HOW TO TURN ON THE POWER

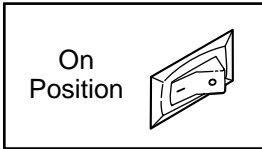
- 1 Plug in the power cord (see page 9).
- 2 Locate the on/off switch near the power cord. Move the on/off switch to the on position.
 
- 3 Stand on the foot rails of the treadmill. Find the clip attached to the key (see the drawing on page 10) and slide the clip onto the waistband of your clothes. Next, route the cord attached to the clip **under the handgrip pulse sensor**, and insert the key into the console. After a moment, the displays and various indicators will light. **Test the clip by carefully taking a few steps backward until the key is pulled from the console. If the key is not pulled from the console, adjust the position of the clip.**

HOW TO USE THE MANUAL MODE

- 1 **Insert the key fully into the console.**
See HOW TO TURN ON THE POWER above.
- 2 **Select the manual mode.**
When the key is inserted, the manual mode will be selected and the Manual Control indicator will light. If a program has been selected, press the Program Select button repeatedly to reselect the manual mode.
 
- 3 **Press the Start button or the Speed Δ button to start the walking belt.**

A moment after the button is pressed, the walking belt will begin to move at 1 mph. Hold the handrails and begin walking. As you exercise, change the speed of the walking belt as desired by pressing the Speed ∇ and Δ buttons.

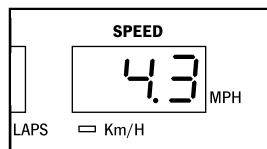

Each time a button is pressed, the speed setting will change by 0.1 mph; if a button is held down, the speed setting will change in increments of 0.5 mph. To change the speed setting quickly, press the OneTouch Speed buttons. **Note: The console can display speed and distance in either miles or kilometers. For simplicity, all instructions in this section refer to miles.**

To stop the walking belt, press the Stop button. The Time/Segment Time/Pace display will begin to flash. To restart the walking belt, press the Start button or the Speed Δ button.

Note: The first time the treadmill is used, observe the alignment of the walking belt, and align the walking belt if necessary (see page 27).

- 4 **Change the incline of the treadmill as desired.**

To change the incline of the treadmill, press the Incline buttons. Each time a button is pressed, the incline will change by 0.5%. Note: After the buttons are pressed, it may take a moment for the treadmill to reach the selected incline setting.

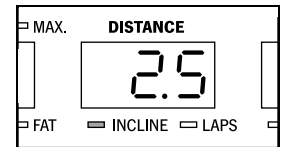

- 5 **Follow your progress with the LED matrix and the displays.**

The LED matrix—When the manual mode or the iFIT.com mode is selected, the LED matrix will show a track representing 1/4 mile. As you exercise, the indicators around the track will light in sequence until you have completed 1/4 mile. A new lap will then begin.

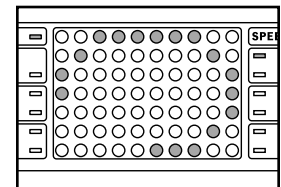

Time/Segment Time/Pace display

—When the manual mode or the iFIT.com mode is selected, this display will show the elapsed time and your current pace (pace is measured in *minutes per mile*). The display will change from one number to the other every few seconds. When a preset program or a heart rate program is selected, the display will show the time *remaining* in the program, the time remaining in the current segment of the program, and your current pace.

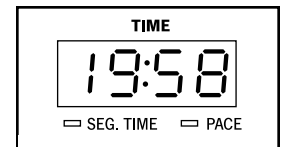

Pulse/Calories/Fat

Calories display—This display shows the approximate numbers of *calories* and *fat calories* you have burned (see

FAT BURNING on page 28). The display will change from one number to the other every few seconds. The display will also show your heart rate when you use the handgrip pulse sensor (see step 6 at the right) or the chest pulse sensor (see page 8).

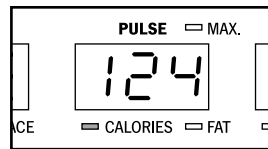

Distance/Incline/Laps

display—This display shows the distance that you have walked, the incline level of the treadmill, and the number of 1/4-mile laps you have completed. The display will change from one number to the next every few seconds. Note: Each time the incline changes, the display will show the current incline setting for several seconds.

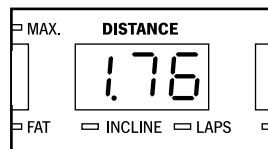

Speed display—This display shows the speed of the walking belt.

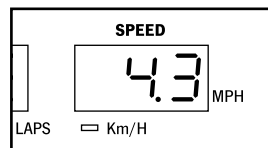

Note: When the Km/H indicator is lit, the console will display speed and distance in kilometers; when the Km/H indicator is not lit, the console will display speed and distance in miles. To change the unit of measurement, first hold down the Stop button while inserting the key into the console. An “E” for English miles or an “M” for metric kilometers will appear in the Speed display. Press the Speed Δ button to change the unit of measurement. When the desired unit of measurement is selected, remove the key and then reinsert it.

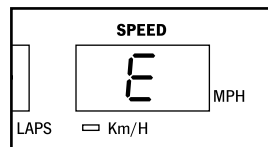

To reset the displays, press the Stop button, remove the key, and then reinsert the key.

6 Measure your heart rate if desired.

You can measure your heart rate using either the handgrip pulse sensor (see the instructions below) or the chest pulse sensor (see page 8).

To use the handgrip pulse sensor, first make sure that your hands are clean. Next, **stand on the foot rails** and place your

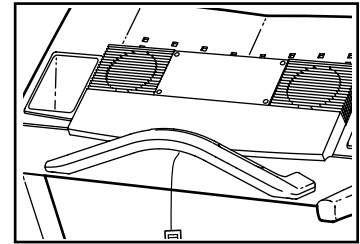

hands on the metal contacts on the handgrip pulse sensor. Your palms should be resting on the upper contacts and your fingertips should be touching the lower contacts. **Avoid moving your hands.** When your pulse is detected, two dashes (--) will appear in the Pulse/Calories/Fat Calories display, and then your heart rate will be shown. **For the most accurate heart rate reading, continue to hold the contacts for about 15 seconds.**

7 Turn on the fans if desired.

To use the fans, press the Low or High button. To turn off the fans, press the Off button. Note: Any time that the walking belt is stopped for a few minutes, the fans will automatically turn off.

8 When you are finished exercising, remove the key from the console.

Step onto the foot rails, press the Stop button, and **adjust the incline of the treadmill to the lowest setting. The incline must be at the lowest setting when the treadmill is folded to the storage position or the treadmill will be damaged.** Next, remove the key from the console and put it in a secure place. **Note: If the displays and various indicators on the console remain lit after the key is removed, the console is in the “demo” mode. See page 23 and turn off the demo mode.**

When you are finished using the treadmill, move the on/off switch near the power cord to the off position and unplug the power cord.

HOW TO USE PRESET WORKOUT PROGRAMS

1 Insert the key fully into the console.

See HOW TO TURN ON THE POWER on page 11.

2 Select one of the preset workout programs.

When the key is inserted, the manual mode will be selected. To select a preset workout program, press the Program Select button repeatedly until one of the Walk, Jog, or Run indicators lights.

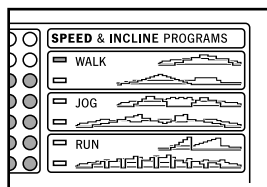

When a preset workout program is selected, the Distance/Incline/Laps display will flash the maximum incline setting for the program, and the Speed display will flash the maximum speed setting, for six seconds. The Time/Segment Time/Pace display will show how long the program will last.

The LED matrix will show the first seven speed settings for the program. The profiles on the right side of the LED matrix show how the speed and incline of the treadmill will change during the programs.

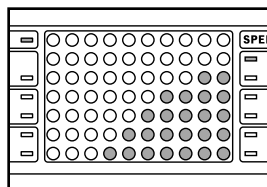

3 Press the Start button or the Speed Δ button to start the program.

A moment after the button is pressed, the treadmill will automatically adjust to the first speed and incline settings of the program. Hold the handrails and begin walking.

Each program is divided into several time segments of different lengths. (The Time/Segment Time/Pace display will show both the time remaining in the program and the time remaining in the current segment of the program.) One speed setting and one incline setting are programmed for each segment. (The same speed and/or incline setting may be programmed for consecutive segments.)

The speed setting for the first segment is shown in the flashing Current Segment column of the LED matrix. (The incline settings are not shown in the matrix.) The speed settings for the next seven segments are shown in the seven columns to the right.

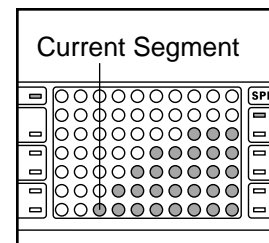

When only three seconds remain in the first segment of the program, both the Current Segment column and the column to the right will flash and a series of tones will sound. In addition, if the speed and/or incline of the treadmill is about to change, the Speed display and/or the Distance/Incline/Laps display will flash to alert you. When the first segment is completed, *all speed settings will move one column to the left*. The speed setting for the second segment will then be shown in the flashing Current Segment column and the treadmill will automatically adjust to the speed and incline settings for the second segment. Note: If all of the indicators in the Current Segment column are lit after the speed settings have moved to the left, *the speed settings will move downward* so that only the highest indicators appear in the LED matrix. If some of the indicators in the Current Segment column are not lit when the speed settings move to the left again, the speed settings will move back up.

The program will continue in this way until the speed setting for the last segment is shown in the Current Segment column and the Time/Segment Time/Pace display counts down to zero. The walking belt will then slow to a stop.

If the speed or incline setting is too high or too low during the program, you can manually override the setting by pressing the Speed or Incline buttons. Every few times a Speed button is pressed, an additional indicator will light or darken in the Current Segment column. (If any of the columns to the right of the Current Segment column have the same number of lit indicators as the Current Segment column, an additional indicator may light or darken in those columns as well.) **Note: If you manually override the speed or incline setting, when the next segment begins, the treadmill will automatically adjust to the speed and incline settings for the next segment.**

To stop the program temporarily, press the Stop button. The Time/Segment Time/Pace display will begin to flash. To restart the program, press the Start button or the Speed Δ button. To end the program, press the Stop button, remove the key, and then reinsert the key.

4 Follow your progress with the displays.

See step 5 on page 11.

5 Measure your heart rate if desired.

See step 6 on page 12.

6 Turn on the fans if desired.

See step 7 on page 12.

7 When the program is finished, remove the key from the console.

When the program has ended, **make sure that the incline of the treadmill is at the lowest setting.** Next, remove the key from the console and put it in a safe place. **Note: If the displays and various indicators on the console remain lit after the key is removed, the console is in the “demo” mode. Refer to page 23 and turn off the demo mode.**

When you are finished using the treadmill, move the on/off switch near the power cord to the off position and unplug the power cord.

HOW TO USE HEART RATE PROGRAMS

⚠ CAUTION: If you have heart problems, or if you are over 60 years of age and have been inactive, do not use the heart rate programs. If you are taking medication regularly, consult your physician to find whether the medication will affect your exercise heart rate.

Follow the steps below to use a heart rate program.

Note: You must wear the chest pulse sensor (see page 8) to use a heart rate program.

1 Put on the chest pulse sensor.

See HOW TO PUT ON THE CHEST PULSE SENSOR page 8.

2 Insert the key fully into the console.

See HOW TO TURN ON THE POWER on page 11.

3 Select a heart rate program.

When the key is inserted, the manual mode will be selected.

To select a heart rate program, press the Program Select button

repeatedly until one of the heart rate program indicators lights.

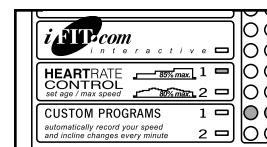

The two profiles on the left side of the LED matrix show how the target heart rate will change during the programs. During heart rate program 1, your heart rate will reach approximately 85% of your estimated maximum heart rate; during heart rate program 2, your heart rate will reach approximately 80% of your estimated maximum heart rate. Note: Your estimated maximum heart rate is determined by subtracting your age from 220. For example, if you are 30 years old, your estimated maximum heart rate is 190 beats per minute ($220 - 30 = 190$).

During heart rate programs, the LED matrix will show a graphic that represents your heart rate. Each time a heart-beat is detected, an additional peak will appear.

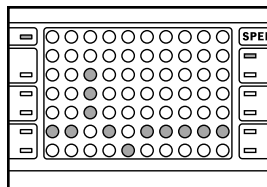

4 Enter your age and a maximum speed setting.

When a heart rate program is selected, the word "AGE" and the current age setting will flash in the Pulse/Calories/Fat Calories display. If you have already entered your age, simply press the Enter button. If you have not entered your age, press the Δ and ∇ buttons beside the Enter button to enter your age. Then, press the Enter button.



After you have entered your age, the letters "SPd" and the maximum speed setting for the program will flash in the Pulse/Calories/Fat Calories display. If desired, press the Δ and ∇ buttons beside the Enter button to adjust the maximum speed setting. When the desired setting is shown, press the Enter button.

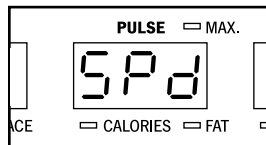

5 Press the Start button or the Speed Δ button to start the program.

A moment after the button is pressed, the treadmill will automatically adjust to the first speed and incline settings for the program. Hold the handrails and begin walking.

Each heart rate program is divided into several time segments of different lengths. (The Time/Segment Time/Pace display will show both the time remaining in the program and the time remaining in the current segment of the program.) One target heart rate setting is programmed for each segment.

During each segment, the console will regularly compare your heart rate to the current target heart rate setting. If your heart rate is too far below or above the target heart rate setting, the speed of

the treadmill will automatically increase or decrease to bring your heart rate closer to the target heart rate setting. If the speed reaches the maximum speed setting for the program (see step 4 at the left) and your heart rate is still too far below the current target heart rate setting, the incline of the treadmill will also increase to bring your heart rate closer to the target heart rate setting.

During the last three seconds of each segment, a series of tones will sound and the Distance/Incline/Laps display and the Speed display will flash.

The program will continue until no time remains in the program. The walking belt will then slow to a stop.

If the speed or incline setting is too high or too low during the program, you can adjust the setting with the Speed or Incline buttons. However, each time the console compares your heart rate to the current target heart rate setting, the speed and/or incline of the treadmill may automatically change to bring your heart rate closer to the target heart rate setting.

If your pulse is not detected during the program, the letters "PLS" will flash in the Pulse/Calories/Fat Calories display and the speed and incline of the treadmill may automatically decrease until your pulse is detected. If this occurs, refer to the instructions on page 8.

To stop the program at any time, press the Stop button. Heart rate programs should not be stopped temporarily and then restarted. To use a heart rate program again, reselect the program and start it at the beginning.

6 Follow your progress with the displays.

See step 5 on page 11.

7 Turn on the fans if desired.

See step 7 on page 12.

8 When the program is finished, remove the key from the console.

See step 7 on page 14.

HOW TO CREATE CUSTOM PROGRAMS

1 Insert the key fully into the console.

See HOW TO TURN ON THE POWER on page 11.

2 Select one of the custom programs.

When the key is inserted, the manual mode will automatically be selected. To select a custom program, first press the Program

Select button repeatedly until one of the custom program indicators lights.

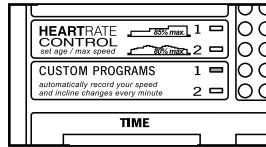

Note: If the custom program has not yet been defined, only three columns of indicators will be lit in the LED matrix. If more than three columns of indicators are lit, see HOW TO USE CUSTOM PROGRAMS on page 17.

3 Press the Start button or the Speed Δ button and program the desired speed and incline settings.

A moment after the button is pressed, the walking belt will begin to move. Hold the handrails and begin walking.

Refer to the LED matrix. Each custom program is divided into one-minute segments. One speed setting and one incline setting can be programmed for each segment. The speed setting for the first segment will be shown in the flashing Current Segment column of the LED matrix. (The in-

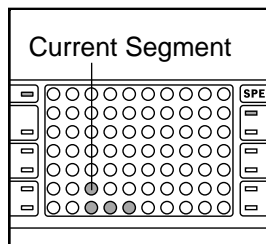

cline settings are not shown in the matrix.) To program a speed setting and an incline setting for the first segment, simply adjust the speed and incline of the treadmill as desired by pressing the Speed and Incline buttons. Every few times a Speed button is pressed, an additional indicator will light or darken in the Current Segment column.

When the first segment of the program is completed, a series of tones will sound and the current speed setting and the current incline setting will be saved in memory. *The three columns of indicators will then move one column to the left, and the speed setting for the second segment will be shown in the flashing Current Segment column.* Program a speed setting and an incline setting for the second segment as described above.

Continue programming speed and incline settings for as many segments as desired; custom programs can have up to forty segments. When you are finished with your workout, press the Stop button twice. The speed and incline settings that you programmed and the number of segments that you programmed will then be saved in memory.

4 When the program has ended, remove the key.

See step 7 on page 14.

HOW TO USE CUSTOM PROGRAMS

1 Insert the key fully into the console.

See HOW TO TURN ON THE POWER on page 11.

2 Select one of the custom programs.

When the key is inserted, the manual mode will automatically be selected. To select a custom program, first press the Program

Select button repeatedly until one of the custom program indicators lights.

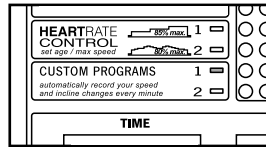

When a custom program is selected, the Distance/Incline/Laps display will flash the maximum incline setting for the program, and the Speed display will flash the maximum speed setting, for six seconds. The Time/Segment Time/Pace display will show how long the program will last.

The LED matrix will show the first seven speed settings for the program. **Note: If only three columns of indicators are lit in the matrix, see HOW TO CREATE A CUSTOM PROGRAM on page 16.**

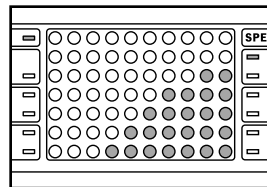

3 Press the Start button or the Speed Δ button to start the program.

A moment after the button is pressed, the treadmill will automatically adjust to the first speed and incline settings for the program. Hold the handrails and begin walking.

Each custom program is divided into several one-minute segments. One speed setting and one incline setting are programmed for each segment. (The same speed and/or incline setting may be programmed for consecutive segments.)

The speed setting for the first segment is shown in the flashing Current Segment column of the LED matrix. (The incline settings are not shown in the matrix.)

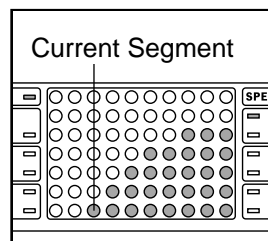

The speed settings for the next seven segments are shown in the seven columns to the right.

When only three seconds remain in the first segment of the program, both the Current Segment column and the column to the right will flash, a series of tones will sound, and the Speed display and/or the Distance/Incline/Laps display will flash. When the first segment is completed, *all speed settings will move one column to the left*. The speed setting for the second segment will then be shown in the flashing Current Segment column and the treadmill will automatically adjust to the second speed and incline settings that you programmed previously.

The program will continue in this way until the speed setting for the last segment is shown in the Current Segment column and the last segment ends. The walking belt will then slow to a stop.

If desired, you can redefine to the program while using it. **To change the speed or incline setting during the current segment**, simply press the Speed or Incline buttons. When the current segment is completed, the new setting will be saved in memory. **To increase the length of the program**, first wait until the program is completed. Then, press the Start button and program speed and incline settings for as many additional segments as desired. When you have added as many segments as desired, press the Stop button twice. **To decrease the length of the program**, press the Stop button twice at any time before the program is completed.

To stop the program temporarily, press the Stop button. The Time/Segment Time/Pace display will begin to flash. To restart the program, press the Start button or the Speed Δ button. To end the program, press the Stop button, remove the key, and then reinsert the key.

4 Follow your progress with the displays.

See step 5 on page 11.

5 Measure your heart rate if desired.

See step 6 on page 12.

6 Turn on the fans if desired.

See step 7 on page 12.

7 When the program has ended, remove the key.

See step 7 on page 14.

HOW TO CONNECT THE TREADMILL TO YOUR CD PLAYER, VCR, OR COMPUTER

To use **iFIT.com CD's**, the treadmill must be connected to your portable CD player, portable stereo, home stereo, or computer with CD player. See pages 18 and 19 for connecting instructions. To use **iFIT.com videocassettes**, the treadmill must be connected to your VCR. See page 20 for connecting instructions. To use **iFIT.com programs directly from our Web site**, the treadmill must be connected to your home computer. See page 19 for connecting instructions.

HOW TO CONNECT YOUR PORTABLE CD PLAYER

Note: If your CD player has separate **LINE OUT** and **PHONES** jacks, see instruction A below. If your CD player has only one jack, see instruction B.

- A. Plug one end of the audio cable into the jack on the front of the treadmill near the power cord. Plug the other end of the cable into the **LINE OUT** jack on your CD player. Plug your headphones into the **PHONES** jack.

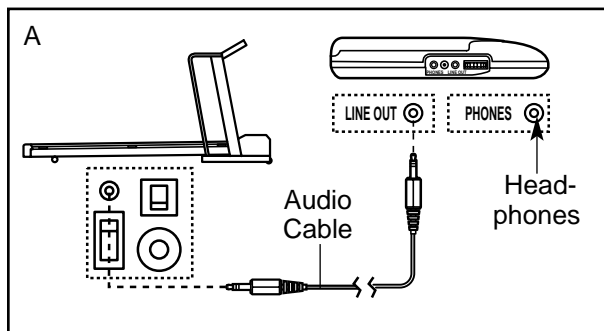

- B. Plug one end of the audio cable into the jack on the front of the treadmill near the power cord. Plug the other end of the cable into a 3.5mm Y-adapter (available at electronics stores). Plug the Y-adapter into the **PHONES** jack on your CD player. Plug your headphones into the other side of the Y-adapter.

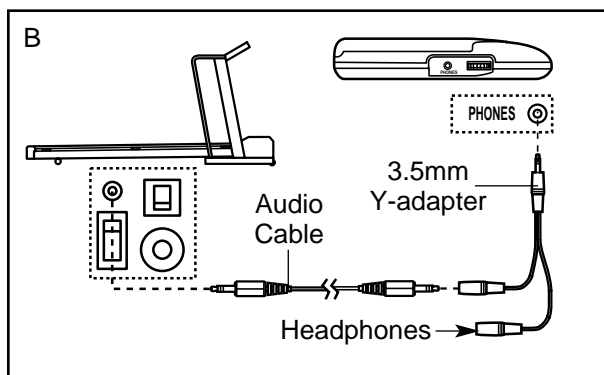

HOW TO CONNECT YOUR PORTABLE STEREO

Note: If your stereo has an **RCA-type AUDIO OUT** jack, see instruction A below. If your stereo has a **3.5mm LINE OUT** jack, see instruction B. If your stereo has only a **PHONES** jack, see instruction C.

- A. Plug one end of the audio cable into the jack on the front of the treadmill near the power cord. Plug the other end of the cable into the included adapter. Plug the adapter into an **AUDIO OUT** jack on your stereo.

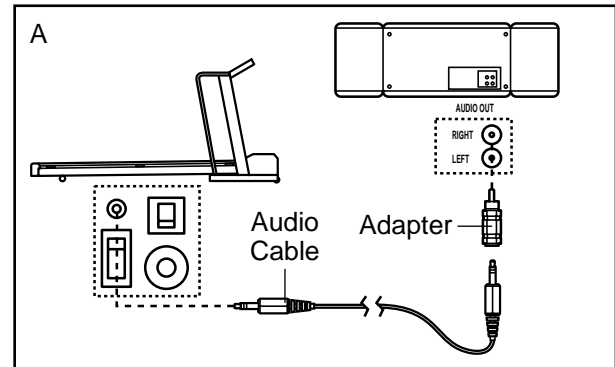

- B. Plug one end of the audio cable into the jack on the front of the treadmill near the power cord. Plug the other end of the cable into the **LINE OUT** jack on your stereo.

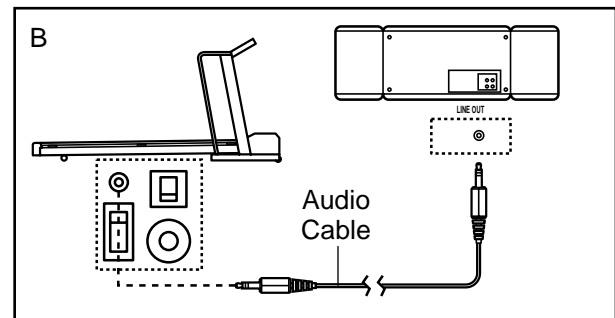

- C. Plug one end of the audio cable into the jack on the front of the treadmill near the power cord. Plug the other end of the cable into a 3.5mm Y-adapter (available at electronics stores). Plug the Y-adapter into the **PHONES** jack on your stereo. Plug your headphones into the other side of the Y-adapter.

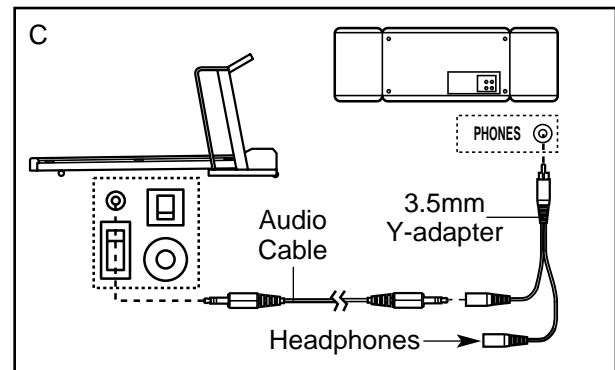

HOW TO CONNECT YOUR HOME STEREO

Note: If your stereo has an unused **LINE OUT** jack, see instruction **A** below. If the **LINE OUT** jack is being used, see instruction **B**.

- A. Plug one end of the audio cable into the jack on the front of the treadmill near the power cord. Plug the other end of the cable into the included adapter. Plug the adapter into the **LINE OUT** jack on your stereo.

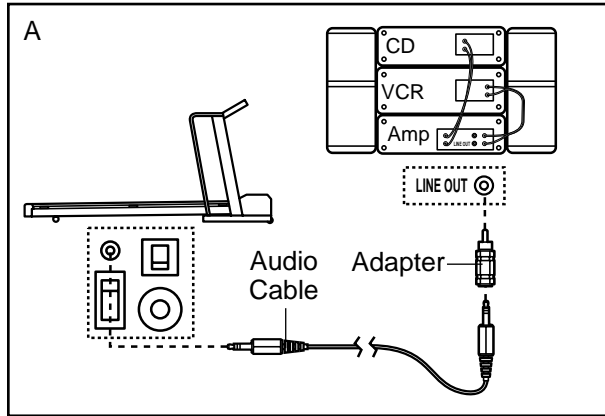

- B. Plug one end of the audio cable into the jack on the front of the treadmill near the power cord. Plug the other end of the cable into the included adapter. Plug the adapter into an **RCA Y-adapter** (available at electronics stores). Next, remove the wire that is currently plugged into the **LINE OUT** jack on your stereo and plug the wire into the unused side of the **Y-adapter**. Plug the **Y-adapter** into the **LINE OUT** jack on your stereo.

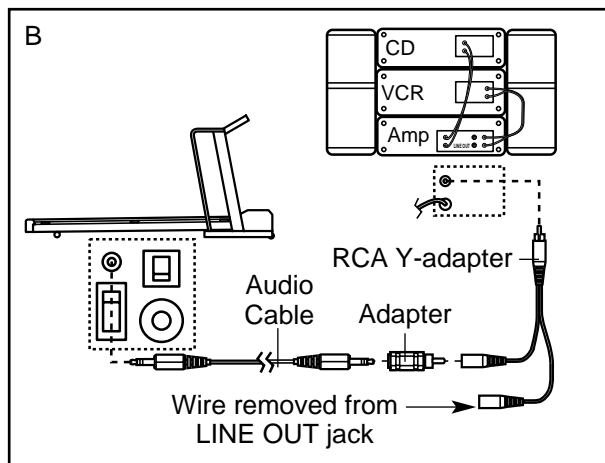

HOW TO CONNECT YOUR COMPUTER

Note: If your computer has a **3.5mm LINE OUT** jack, see instruction **A**. If your computer has only a **PHONES** jack, see instruction **B**.

- A. Plug one end of the audio cable into the jack on the front of the treadmill near the power cord. Plug the other end of the cable into the **LINE OUT** jack on your computer.

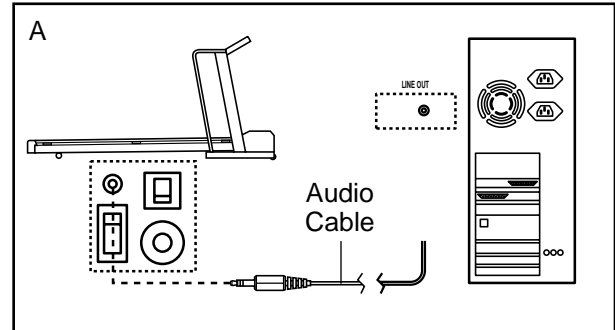

- B. Plug one end of the audio cable into the jack on the front of the treadmill near the power cord. Plug the other end of the cable into a **3.5mm Y-adapter** (available at electronics stores). Plug the **Y-adapter** into the **PHONES** jack on your computer. Plug your headphones or speakers into the other side of the **Y-adapter**.

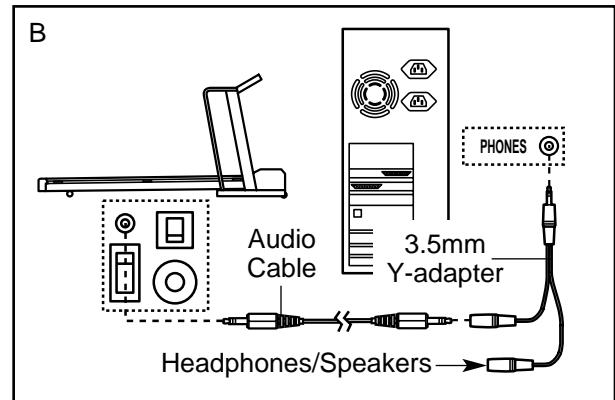

HOW TO CONNECT YOUR VCR

Note: If your VCR has an unused AUDIO OUT jack, see instruction A below. If the AUDIO OUT jack is being used, see instruction B. If you have a TV with a built-in VCR, see instruction B. If your VCR is connected to your home stereo, see **HOW TO CONNECT YOUR HOME STEREO** on page 19.

- A. Plug one end of the audio cable into the jack on the front of the treadmill near the power cord. Plug the other end of the cable into the included adapter. Plug the adapter into the AUDIO OUT jack on your VCR.

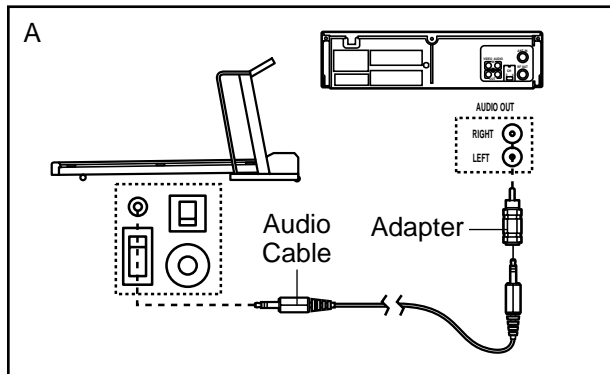

- B. Plug one end of the audio cable into the jack on the front of the treadmill near the power cord. Plug the other end of the cable into the included adapter. Plug the adapter into an RCA Y-adapter (available at electronics stores). Next, remove the wire that is currently plugged into the AUDIO OUT jack on your VCR and plug the wire into the unused side of the Y-adapter. Plug the Y-adapter into the AUDIO OUT jack on your VCR.

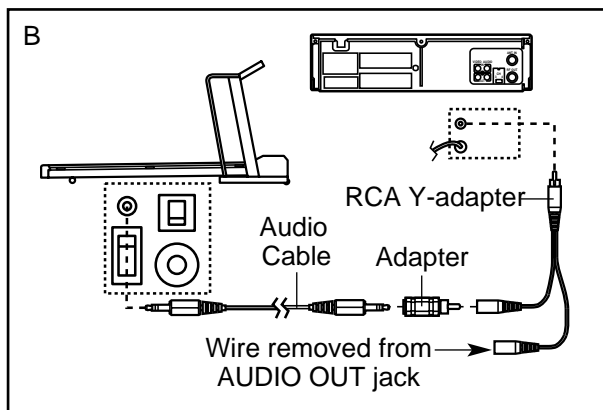

HOW TO USE iFIT.COM CD AND VIDEO PROGRAMS

To use iFIT.com CD's or videocassettes, the treadmill must be connected to your portable CD player, portable stereo, home stereo, computer with CD player, or VCR. See **HOW TO CONNECT THE TREADMILL TO YOUR CD PLAYER, VCR, OR COMPUTER** on page 18. **Note:** To purchase iFIT.com CD's or iFIT.com videocassettes, call toll-free 1-800-735-0768.

Follow the steps below to use an iFIT.com CD or video program.

1 Insert the key into the console.

See **HOW TO TURN ON THE POWER** on page 11.

2 Select the iFIT.com mode.

When the key is inserted, the manual mode will be selected. To use iFIT.com CD's or videocassettes, press the Program Select button repeatedly until the iFIT.com indicator lights.



3 Insert the iFIT.com CD or videocassette.

If you are using an iFIT.com CD, insert the CD into your CD player. If you are using an iFIT.com videocassette, insert the videocassette into your VCR.

4 Press the PLAY button on your CD player or VCR.

A moment after the button is pressed, your personal trainer will begin guiding you through your workout. Simply follow your personal trainer's instructions. Note: If the Time/Segment Time/Pace display is flashing, press the Start button or the Speed Δ button on the console. The treadmill will not respond to a CD or video program when the Time/Segment Time/Pace display is flashing.

During the CD or video program, an electronic "chirping" sound will alert you when the speed and/or incline of the treadmill is about to change. **CAUTION: Always listen for the "chirp" and be prepared for speed and/or incline changes. In some instances, the speed and/or incline may change before the personal trainer describes the change.**

If the speed or incline settings are too high or too low, you can manually override the settings at any time by pressing the Speed or Incline buttons on the console. However, **when the next “chirp” is heard, the speed and/or incline will change to the next settings of the CD or video program.**

To stop the walking belt at any time, press the Stop button on the console. The Time/Segment Time/Pace display will begin to flash. To restart the program, press the Start button or the Speed Δ button. After a moment, the walking belt will begin to move at 1 mph. **When the next “chirp” is heard, the speed and incline will change to the next settings of the CD or video program.**

When the CD or video program is completed, the walking belt will stop and the Time/Segment Time/Pace display will begin to flash. Note: To use another CD or video program, press the Stop button or remove the key and go to step 1 on page 20.

Note: If the speed or incline of the treadmill does not change when a “chirp” is heard:

- **Make sure that the iFIT.com indicator is lit and that the Time/Segment Time/Pace display is not flashing. If the Time/Segment Time/Pace display is flashing, press the Start button or the Speed Δ button on the console.**
- **Adjust the volume of your CD player or VCR. If the volume is too high or too low, the console may not detect the program signals.**

- **Make sure that the audio cable is properly connected, that it is fully plugged in, and that it is not wrapped around a power cord.**
- **If you are using your portable CD player and the CD skips, set the CD player on the floor or another flat surface instead of on the console.**

5 Follow your progress with the LED track and the displays.

See step 5 on page 11.

6 Measure your heart rate, if desired.

Refer to step 6 on page 12.

7 Turn on the fans if desired.

See step 7 on page 12.

8 When the program is completed, remove the key.

See step 7 on page 14.

CAUTION: Always remove iFIT.com CD's and videocassettes from your CD player or VCR when you are finished using them.

HOW TO USE PROGRAMS DIRECTLY FROM OUR WEB SITE

Our Web site at www.iFIT.com allows you to access basic programs, audio programs, and video programs directly from the internet. Additional options are soon to be available. See www.iFIT.com for details.

To use programs from our Web site, the treadmill must be connected to your home computer. See HOW TO CONNECT YOUR COMPUTER on page 19. In addition, you must have an internet connection and an internet service provider. A list of specific system requirements are found on our Web site.

Follow the steps below to use a program from our Web site.

1 Insert the key into the console.

See HOW TO TURN ON THE POWER on page 11.

2 Select the iFIT.com mode.

When the key is inserted, the manual mode will be selected.

To use a program from our Web site, press the Program Select button repeatedly until the iFIT.com indicator lights.



3 Go to your computer and start an internet connection.

4 Start your web browser, if necessary, and go to our Web site at www.iFIT.com.

5 Follow the desired links on our Web site to select a program.

Read and follow the on-line instructions for using a program.

6 Follow the on-line instructions to start the program.

When you start the program, an on-screen countdown will begin.

7 Return to the treadmill and stand on the foot pads. Find the clip attached to the key and slide the clip onto the waistband of your clothes.

When the on-screen countdown ends, the program will begin and the walking belt will begin to move. Hold the handrails, step onto the walking belt, and begin walking. During the program, an electronic “chirping” sound will alert you when the speed and/or incline of the treadmill is about to change. **CAUTION: Always listen for the “chirp” and be prepared for speed and/or incline changes.**

If the speed or incline settings are too high or too low, you can manually override the settings at any time by pressing the Speed or Incline buttons on the console. **However, when the next “chirp” is heard, the speed and/or incline will change to the next settings for the program.**

To stop the walking belt at any time, press the Stop button on the console. The Time/Segment Time/Pace display will begin to flash. To restart the program, press the Start button or the Speed Δ button. After a moment, the walking belt will begin to move at 1 mph. **When the next “chirp” is heard, the speed and incline will change to the next settings of the program.**

When the program is completed, the walking belt will stop and the Time/Segment Time/Pace display will begin to flash. Note: To use another program, press the Stop button and go to step 5.

Note: If the speed or incline of the treadmill does not change when a “chirp” is heard, make sure that the iFIT.com indicator is lit and that the Time/Segment Time/Pace display is not flashing. In addition, make sure that the audio cable is properly connected, that it is fully plugged in, and that it is not wrapped around a power cord.

8 Follow your progress with the LED track and the displays.

See step 5 on page 11.

9 When the program has ended, remove the key.

See step 7 on page 14.

THE INFORMATION MODE/DEMO MODE

The console features an information mode that keeps track of the total number of hours that the treadmill has been operated and the total number of miles that the walking belt has moved. The information mode also allows you to switch the console from miles per hour to kilometers per hour. In addition, the information mode allows you to turn on and turn off the demo mode.

To select the information mode, hold down the Stop button while inserting the key into the console. When the information mode is selected, the following information will be shown:

The Time/Segment Time/Pace display will show the total number of hours the treadmill has been used.

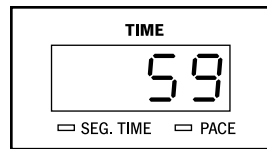

The Distance/Incline/Laps display will show the total number of miles (or kilometers) that the walking belt has moved.

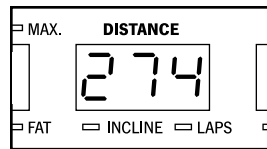

An "E" for English miles or an "M" for metric kilometers will appear in the Speed display. Press the Speed Δ button to change the unit of measurement.

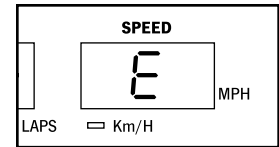

IMPORTANT: The Pulse/Calories/Fat Calories display should be blank. If a "d" appears in the display, the console is in the "demo" mode. This mode is intended

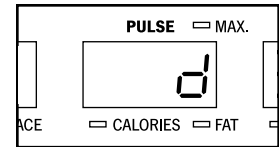

to be used only when a treadmill is displayed in a store. When the console is in the demo mode, the power cord can be plugged in, the key can be removed from the console, and the displays and indicators on the console will automatically light in a preset sequence, although the buttons on the console will not operate. **If a "d" appears in the Pulse/Calories/Fat Calories display when the information mode is selected, press the Speed ∇ button so the display is blank.**

To exit the information mode, remove the key from the console.

HOW TO FOLD AND MOVE THE TREADMILL

HOW TO FOLD THE TREADMILL FOR STORAGE

Before folding the treadmill, adjust the incline to the lowest position. If this is not done, the treadmill may be permanently damaged. Next, unplug the power cord.

CAUTION: You must be able to safely lift 45 pounds (20 kg) to raise, lower, or move the treadmill.

1. Hold the treadmill in the locations shown at the right. **To decrease the possibility of injury, bend your legs and keep your back straight. As you raise the treadmill, make sure to lift with your legs rather than your back.** Raise the treadmill about halfway to the vertical position.

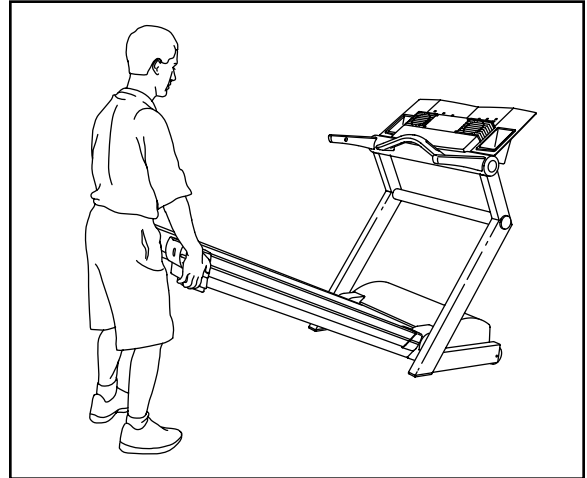

2. Hold the treadmill firmly with your left hand. Using your right hand, pull the lock knob to the right and hold it. Raise the treadmill until the pin on the lock knob is aligned with the hole in the left foam grip. Then, release the lock knob. **Make sure that the lock knob is fully released so that the pin is fully inserted into the hole in the left foam grip.**

To protect the floor or carpet from damage, place a mat under the treadmill. Keep the treadmill out of direct sunlight. Do not leave the treadmill in the storage position in temperatures above 85° Fahrenheit.

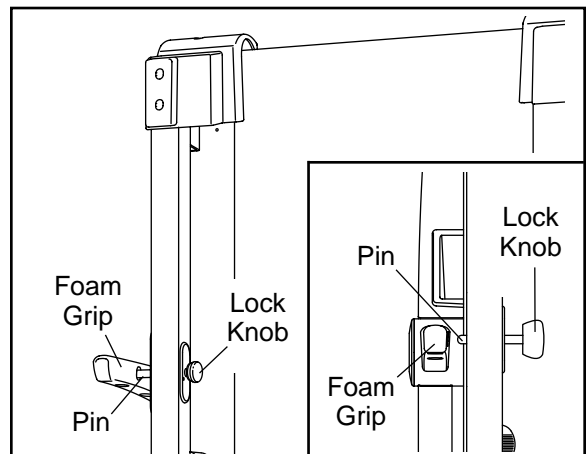

HOW TO MOVE THE TREADMILL

Before moving the treadmill, convert the treadmill to the storage position as described above. **Make sure that the latch pin is securely holding the catch.**

1. Hold the handrails and place one foot on the base.
2. Tilt the treadmill back until it rolls freely on the wheels. Carefully move the treadmill to the desired location. **To reduce the risk of injury, use extreme caution while moving the treadmill. Do not attempt to move the treadmill over an uneven surface.**
3. Place one foot on the wheel, and carefully lower the treadmill until the base is resting in the storage position.

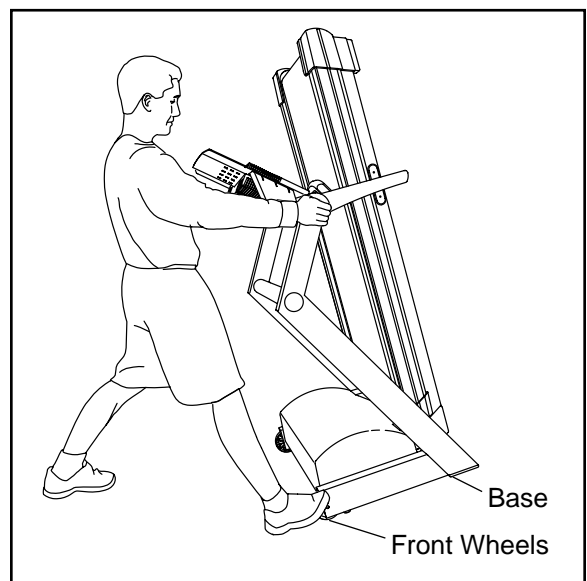

HOW TO LOWER THE TREADMILL FOR USE

1. Hold the treadmill firmly with your left hand. Pull the lock knob to the right. Pivot the treadmill down until the pin on the lock knob is below the foam grip. Slowly release the lock knob.

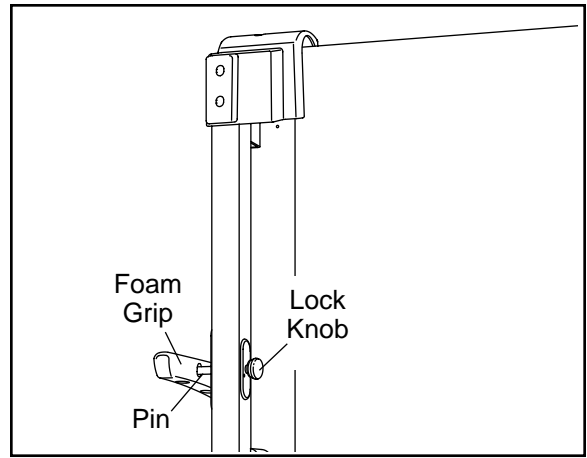

2. Hold the treadmill firmly with both hands, and lower the treadmill to the floor. **To decrease the possibility of injury, bend your legs and keep your back straight.**

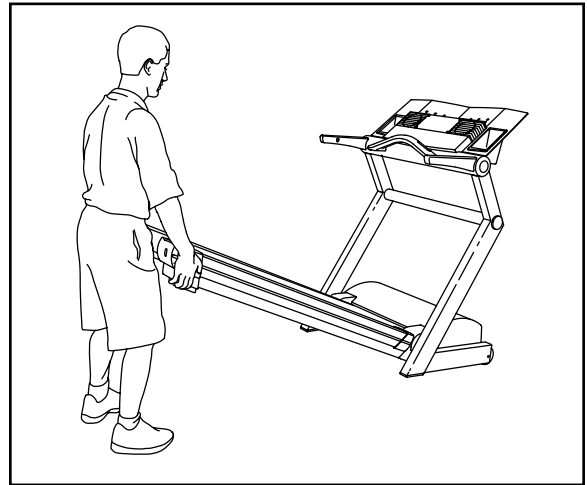

TROUBLESHOOTING

Most treadmill problems can be solved by following the instructions below. If further assistance is needed, please call our Customer Service Department toll-free at 1-800-999-3756, Monday through Friday, 6 a.m. until 6 p.m. Mountain Time (excluding holidays).

PROBLEM

SOLUTION

1. The power does not turn on

a. Make sure that the power cord is plugged into a surge suppressor, and that the surge suppressor is plugged into a properly grounded outlet (see page 9). Use only a single-outlet surge suppressor that meets all of the specifications described on page 9. Important: The treadmill is not compatible with GFCI-equipped outlets.

b. Make sure that the key is fully inserted into the console.

c. Check the circuit breaker located on the frame near the power cord. If the switch protrudes as shown, the circuit breaker has tripped. To reset the circuit breaker, wait for five minutes and then press the switch back in.

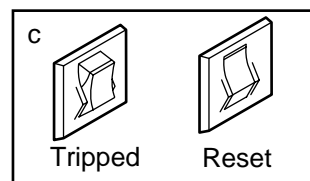

d. Check the on/off switch located on the frame near the power cord. The switch must be in the on position.

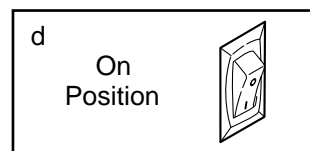

2. The power turns off during use

a. Check the circuit breaker located on the treadmill frame near the power cord (see 1. c. above). If the circuit breaker has tripped, wait for five minutes and then press the switch back in.

b. Make sure that the power cord is plugged in. If the power cord is plugged in, unplug it, wait for five minutes, and then plug it back in.

c. Remove the key from the console and then reinsert it.

d. Make sure that the on/off switch is in the on position (see 1. d. above).

3. The walking belt slows when walked on

a. Use only a single-outlet surge suppressor that meets all of the specifications described on page 9.

b. If the walking belt is overtightened, treadmill performance may decrease and the walking belt may be permanently damaged. Remove the key and **UNPLUG THE POWER CORD**. Using the included allen wrench, turn both rear roller adjustment bolts counterclockwise 1/4 of a turn. When the walking belt is properly tightened, you should be able to lift **the edges** of the walking belt 3 to 4 inches off the walking platform. Be careful to keep the walking belt centered. Plug in the power cord, insert the key and run the treadmill for a few minutes. Repeat until the walking belt is properly tightened.

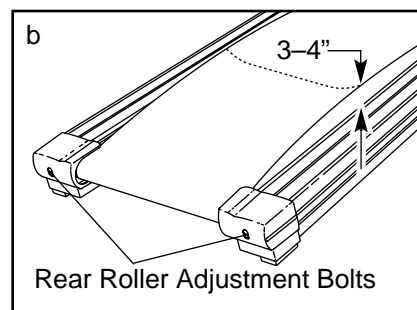

PROBLEM

SOLUTION

4. The walking belt is off-center or slips when walked on

a. If the walking belt is off-center, first remove the key and **UNPLUG THE POWER CORD**. If the walking belt has shifted to the left, use the allen wrench to turn the left rear roller bolt clockwise 1/2 of a turn; if the walking belt has shifted to the right, turn the bolt counterclockwise 1/2 of a turn. Be careful not to overtighten the walking belt. Plug in the power cord, insert the key and run the treadmill for a few minutes. Repeat until the walking belt is centered.

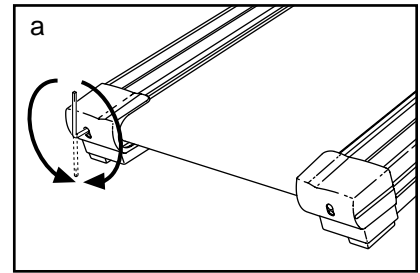

b. If the walking belt slips when walked on, first remove the key and **UNPLUG THE POWER CORD**. Using the allen wrench, turn both rear roller bolts clockwise 1/4 of a turn. When the walking belt is correctly tightened, you should be able to lift each side of the walking belt 3 to 4 inches off the walking platform. Be careful to keep the walking belt centered. Plug in the power cord, insert the key, and walk on the treadmill for a few minutes. Repeat until the walking belt is properly tightened.

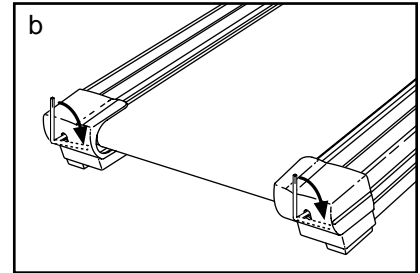

5. The displays of the console do not function properly

a. Remove the key from the console and **UNPLUG THE POWER CORD**. Next, remove the screws from the hood and carefully remove the hood. Locate the Reed Switch (17) and the Magnet (12) on the left side of the Pulley (11). Turn the Pulley until the Magnet is aligned with the Reed Switch. **Make sure that the gap between the Magnet and the Reed Switch is about 1/8"**. If necessary, loosen the indicated Screw (44) and move the Reed Switch slightly. Retighten the Screw. Re-attach the hood and run the treadmill for a few minutes to check for a correct speed reading.

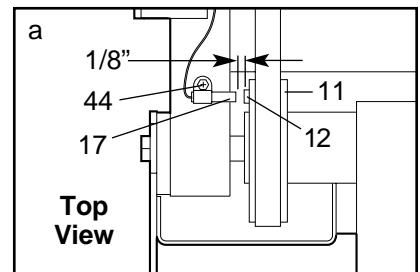

6. The heart rate monitor does not function properly

a. If the heart rate monitor does not function properly, refer to CHEST PULSE SENSOR TROUBLESHOOTING on page 8.

b. If the heart rate monitor still does not function properly, the battery should be changed. To replace the battery, locate the battery cover on the back of the sensor unit. Insert a coin into the slot in the cover and turn the cover counterclockwise to the "open" position. Remove the cover.

Next, remove the old battery from the sensor unit. Insert a new **CR 2032 battery**, making sure that the writing is on top. In addition, make sure that the rubber gasket is in place in the sensor unit. Replace the battery cover and turn it to the closed position.

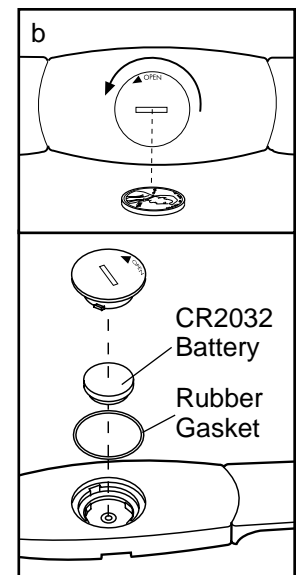

EXERCISE GUIDELINES

⚠️ WARNING: Before beginning this or any exercise program, consult your physician. This is especially important for individuals over the age of 35 or individuals with pre-existing health problems.

The pulse sensors are not medical devices. Various factors, including the user's movement, may affect the accuracy of heart rate readings. The pulse sensors are intended only as exercise aids in determining heart rate trends in general.

The following guidelines will help you to plan your exercise program. For more detailed exercise information, obtain a reputable book or consult your physician.

EXERCISE INTENSITY

Whether your goal is to burn fat or to strengthen your cardiovascular system, the key to achieving the desired results is to exercise with the proper intensity. The proper intensity level can be found by using your heart rate as a guide. The chart below shows recommended heart rates for fat burning and aerobic exercise.

HEART RATE TRAINING ZONES							
AEROBIC	165	155	145	140	130	125	115
MAX FAT BURN	145	138	130	125	118	110	103
FAT BURN	125	120	115	110	105	95	90
Age	20	30	40	50	60	70	80

To find the proper heart rate for you, first find your age near the bottom of the chart (ages are rounded off to the nearest ten years). Next, find the three numbers above your age. The three numbers define your "training zone." The lower two numbers are recommended heart rates for fat burning; the highest number is the recommended heart rate for aerobic exercise.

To measure your heart rate during exercise, use the handgrip pulse sensor or the chest pulse sensor. If your heart rate is too high or too low, adjust the speed or incline of the treadmill.

Fat Burning

To burn fat effectively, you must exercise at a relatively low intensity level for a sustained period of time. During the first few minutes of exercise, your body

uses easily accessible *carbohydrate calories* for energy. Only after the first few minutes does your body begin to use stored *fat calories* for energy. If your goal is to burn fat, adjust the speed or incline of the treadmill until your heart rate is near the lowest number in your training zone.

For maximum fat burning, adjust the speed or incline of the treadmill until your heart rate is near the middle number in your training zone.

Aerobic Exercise

If your goal is to strengthen your cardiovascular system, your exercise must be "aerobic." Aerobic exercise is activity that requires large amounts of oxygen for prolonged periods of time. This increases the demand on the heart to pump blood to the muscles, and on the lungs to oxygenate the blood. For aerobic exercise, adjust the speed or incline of the treadmill until your heart rate is near the highest number in your training zone.

WORKOUT GUIDELINES

Each workout should include the following three parts:

A Warm-up—Start each workout with 5 to 10 minutes of stretching and light exercise. A proper warm-up increases your body temperature, heart rate and circulation in preparation for exercise.

Training Zone Exercise—After warming up, increase the intensity of your exercise until your pulse is in your training zone for 20 to 60 minutes. (During the first few weeks of your exercise program, do not keep your pulse in your training zone for longer than 20 minutes.) Breathe regularly and deeply as you exercise—never hold your breath.

A Cool-down—Finish each workout with 5 to 10 minutes of stretching to cool down. This will increase the flexibility of your muscles and will help prevent post-exercise problems.

EXERCISE FREQUENCY

To maintain or improve your condition, complete three workouts each week, with at least one day of rest between workouts. After a few months, you may complete up to five workouts each week if desired. The key to success is to make exercise a regular and enjoyable part of your everyday life.

SUGGESTED STRETCHES

The correct form for several basic stretches is shown at the right. Move slowly as you stretch—never bounce.

1. Toe Touch Stretch

Stand with your knees bent slightly and slowly bend forward from your hips. Allow your back and shoulders to relax as you reach down toward your toes as far as possible. Hold for 15 counts, then relax. Repeat 3 times. Stretches: Hamstrings, back of knees and back.

2. Hamstring Stretch

Sit with one leg extended. Bring the sole of the opposite foot toward you and rest it against the inner thigh of your extended leg. Reach toward your toes as far as possible. Hold for 15 counts, then relax. Repeat 3 times for each leg. Stretches: Hamstrings, lower back and groin.

3. Calf/Achilles Stretch

With one leg in front of the other, reach forward and place your hands against a wall. Keep your back leg straight and your back foot flat on the floor. Bend your front leg, lean forward and move your hips toward the wall. Hold for 15 counts, then relax. Repeat 3 times for each leg. To cause further stretching of the achilles tendons, bend your back leg as well. Stretches: Calves, achilles tendons and ankles.

4. Quadriceps Stretch

With one hand against a wall for balance, reach back and grasp one foot with your other hand. Bring your heel as close to your buttocks as possible. Hold for 15 counts, then relax. Repeat 3 times for each leg. Stretches: Quadriceps and hip muscles.

5. Inner Thigh Stretch

Sit with the soles of your feet together and your knees outward. Pull your feet toward your groin area as far as possible. Hold for 15 counts, then relax. Repeat 3 times. Stretches: Quadriceps and hip muscles.

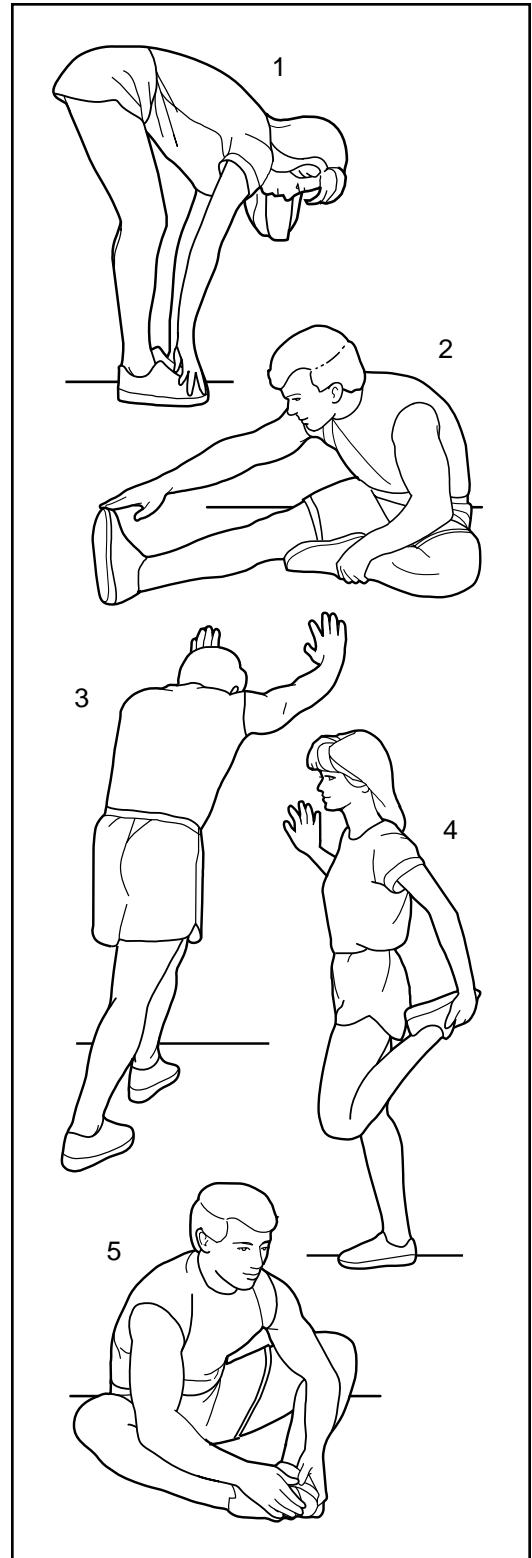

PART LIST—Model No. HRTL07120

R0902C

To locate the parts listed below, refer to the EXPLODED DRAWING attached in the center of this manual.

Key No.	Qty.	Description	Key No.	Qty.	Description
1	2	Foot Rail	51	1	Heart Rate Strap
2	4	Console Cover Screw	52	2	Roller Adj. Washer
3	1	Audio Wire	53	2	Rear Roller Adjustment Bolt
4	4	Isolator	54	1	Left Rear Endcap
5	1	Latch Housing Cover	55	1	Frame
6	1	Platform	56	1	Allen Wrench
7	4	Walking Platform Screw	57	2	Rear Platform Screw
8	1	Walking Belt	58	1	Rear Roller
9	2	Frame Pivot Bolt	59*	1	Idler Assembly
10	4	Frame Pivot Washer	60	1	Audio Wire Nut
11	1	Front Wheel/Pulley	61	1	Pulse Bar
12	1	Magnet	62	1	Left Foam Grip
13	7	Front Roller Nut/Front Wheel Nut	63	1	Idler Arm
14	2	Spacer Insert	64	1	Idler Spring
15	2	Frame Pivot Spacer	65	1	Upright
16	1	Reed Switch Clip	66	4	Belt Guide Screw
17	1	Reed Switch	67	1	Lock Knob
18	1	Lift Frame	68	1	Latch Housing
19	2	Foot Rail Insert	69	1	Lock Knob Spring
20	1	Pulse Receiver Wire	70	1	Lock Pin Collar
21	20	Foot Rail Screw	71	1	Pin Clip
22	1	Motor Belt	72	1	Lock Pin
23	1	Pulse Receiver	73	2	Incline Pivot Bolt
24	1	Motor	74	1	Flywheel
25	1	Transformer	75	4	Plastic Fastener
26	2	Small Upright Endcap	76	2	Handrail Extension
27	4	Hood Bracket	77	2	Front Wheel
28	1	Ground Wire	78	2	Wheel Bolt
29	4	Star Washer	79	1	Pulley Nut
30	1	Right Rear Endcap	80	1	Console
31	1	Lift Motor Bolt	81	1	Console Cover
32	2	Motor Bolt	82	2	Fan
33	1	Outlet Bracket	83	2	Right Pad
34	4	Plastic Stand-off	84	8	Belly Pan Screw
35	1	Power Supply	85	1	Upright Wire Harness
36	1	Power Supply Bracket	86	1	Shock
37	1	Controller	87	2	Large Upright Endcap
38	1	Controller Bracket	88	2	Left Pad
39	1	Motor Hood	89	1	Filter Wire
40	12	3/4" Screw	90	1	Latch Warning Decal
41	1	Motor Belly Pan	91	1	Incline Motor
42	2	Belt Guide	92	1	Motor Controller Wire
43	8	3/4" Tek Screw	93	8	Fan Screw
44	20	Electronics Screw	94	1	Tie Holder Screw
45	1	Left Front Endcap	95	2	Tie Holder
46	1	Right Front Endcap	96	1	Tie
47	1	Ground Screw	97	5	8" Cable Tie
48	2	Rear Foot	98	2	Bumper
49	1	Console Ground Wire	99	1	Idler Arm Bolt
50*	1	Motor Assembly	100	1	On/Off Switch

Key No.	Qty.	Description	Key No.	Qty.	Description
101	1	Circuit Breaker	123	1	Hand Pulse Wire
102	1	Power Cord	124	1	Incline Bracket
103	1	Power Cord Grommet	125	1	Incline Motor Bolt (Bottom)
104	2	Warning Decal	126	4	Controller Screw
105	1	Heart Rate Sensor	127	1	Motor Isolator Plate
106	1	Jack	128	1	Left Cup Holder
107	1	iFIT.com Audio Cable	129	1	Right Cup Holder
108	2	rear Roller Star Washer	130	2	iFIT.com CD
109	1	Pulley Washer	131	8	Extension Screw
110	1	Idler Pulley	132	2	1/2" Screw
111	1	Pulley Spacer	#	1	8" Blue Wire, 2 F
112	2	Outlet Bracket Star Washer	#	1	4" Blue Wire, M/F
113	1	Static Decal	#	1	4" Blue Wire, 2 F
114	1	Book Plate	#	1	Blue Wire, M/F
115	1	Idler Pulley Bolt	#	1	12" Green Wire, F/Ring
116	1	Right Foam Grip	#	1	8" Green Wire, 2 Ring
117	1	Console Base	#	1	14" White Wire, 2 F
118*	1	Latch Assembly	#	1	4" Black Wire, 2 F
119	1	Right Fan Cover	#	1	User's Manual
120	1	Left Fan Cover			
121	2	Motor Bushing			
122	1	Idler Arm Nylon Washer			

* Includes all parts shown in the box

These parts are not illustrated

HOW TO ORDER REPLACEMENT PARTS

To order replacement parts, call our Customer Service Department toll-free at 1-800-999-3756, Monday through Friday, 6 a.m. until 6 p.m. Mountain Time (excluding holidays). To help us assist you, please be prepared to give the following information:

- The MODEL NUMBER of the product (HRTL07120)
- The NAME of the product (HealthRider® R60 treadmill)
- The SERIAL NUMBER of the product (see the front cover of this manual)
- The KEY NUMBER and DESCRIPTION of the part(s) (see the PART LIST on pages 30 and 31)

LIMITED WARRANTY

ICON Health & Fitness, Inc. (ICON), warrants this product to be free from defects in workmanship and material, under normal use and service conditions, for a period of ninety (90) days from the date of purchase. This warranty extends only to the original purchaser. ICON's obligation under this warranty is limited to replacing or repairing, at ICON's option, the product through one of its authorized service centers. All repairs for which warranty claims are made must be pre-authorized by ICON. This warranty does not extend to any product or damage to a product caused by or attributable to freight damage, abuse, misuse, improper or abnormal usage or repairs not provided by an ICON authorized service center; products used for commercial or rental purposes; or products used as store display models. No other warranty beyond that specifically set forth above is authorized by ICON.

ICON is not responsible or liable for indirect, special or consequential damages arising out of or in connection with the use or performance of the product or damages with respect to any economic loss, loss of property, loss of revenues or profits, loss of enjoyment or use, costs of removal or installation or other consequential damages of whatsoever nature. Some states do not allow the exclusion or limitation of incidental or consequential damages. Accordingly, the above limitation may not apply to you.

The warranty extended hereunder is in lieu of any and all other warranties and any implied warranties of merchantability or fitness for a particular purpose is limited in its scope and duration to the terms set forth herein. Some states do not allow limitations on how long an implied warranty lasts. Accordingly, the above limitation may not apply to you.

This warranty gives you specific legal rights. You may also have other rights which vary from state to state.

ICON HEALTH & FITNESS, INC., 1500 S. 1000 W., LOGAN, UT 84321-9813

EXPLODED DRAWING—Model No. HRTL07120

R1202A

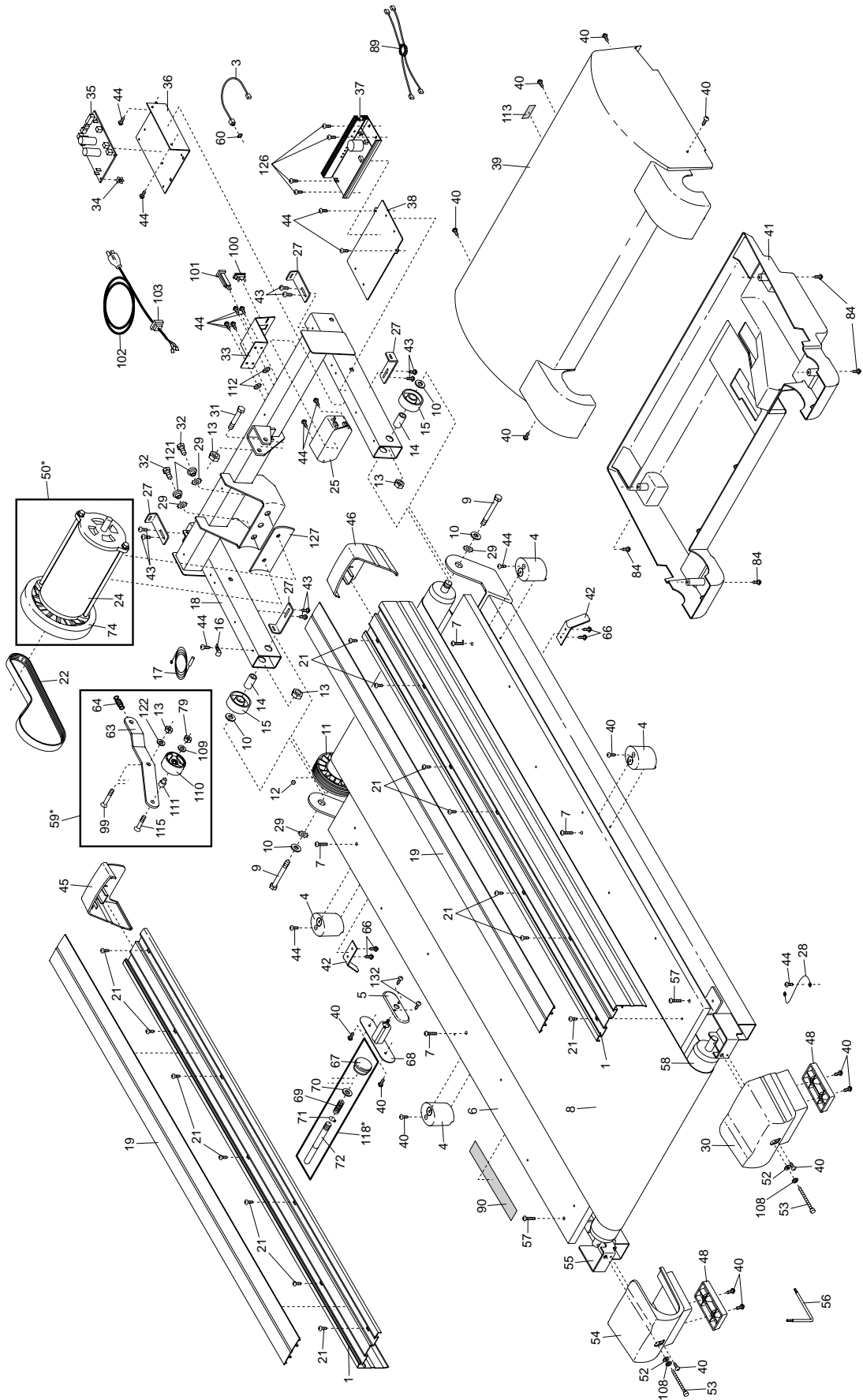

To identify the parts shown on this EXPLODED DRAWING, refer to the PART LIST on pages 30 and 31.

EXPLODED DRAWING—Model No. HRTL07120

R1202A

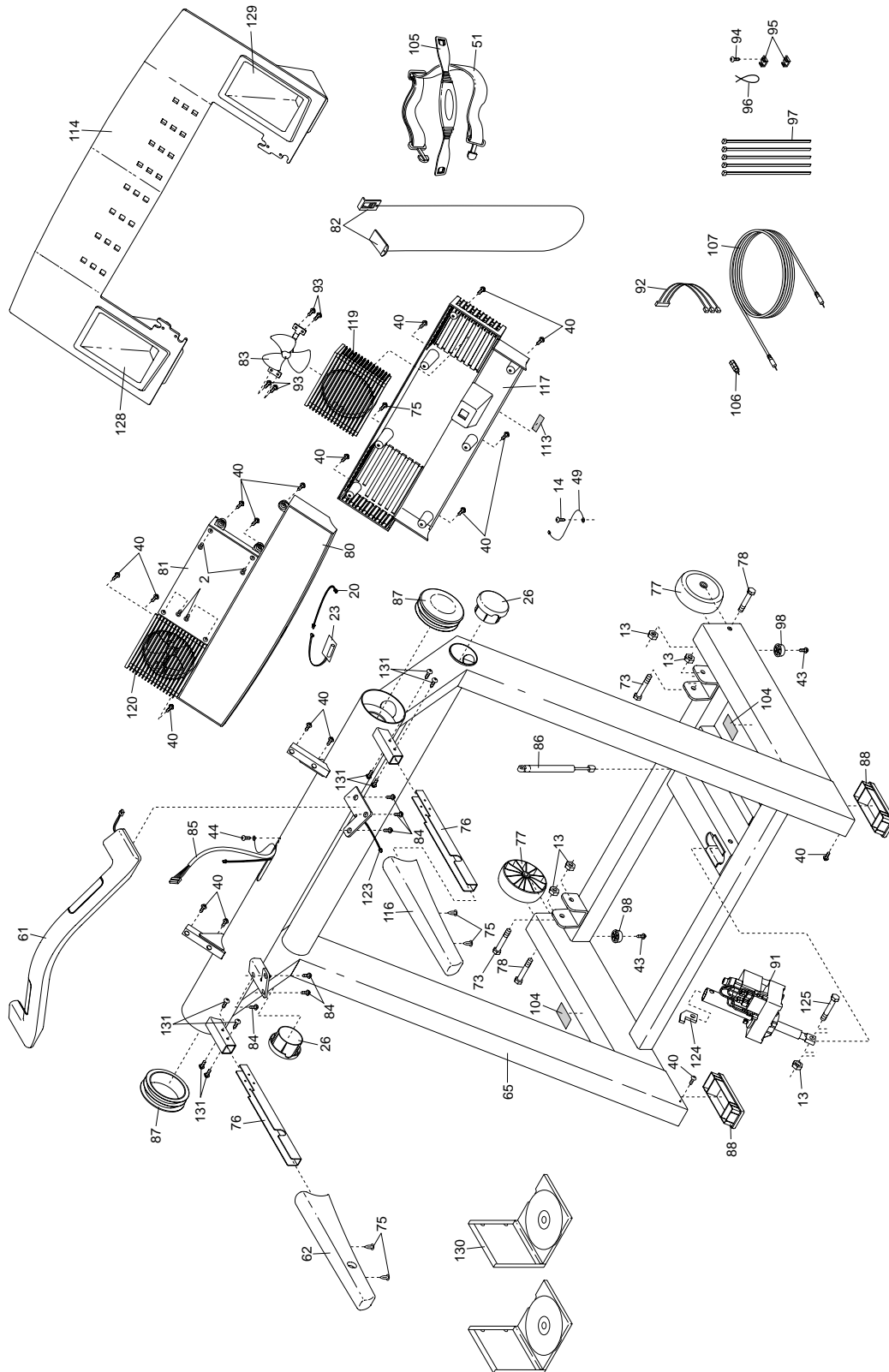

Free Manuals Download Website

<http://myh66.com>

<http://usermanuals.us>

<http://www.somanuals.com>

<http://www.4manuals.cc>

<http://www.manual-lib.com>

<http://www.404manual.com>

<http://www.luxmanual.com>

<http://aubethermostatmanual.com>

Golf course search by state

<http://golfingnear.com>

Email search by domain

<http://emailbydomain.com>

Auto manuals search

<http://auto.somanuals.com>

TV manuals search

<http://tv.somanuals.com>