

HEAT CONTROLLER, INC.

OWNER'S MANUAL

Room Air Heat Pump with R-410A: RAH-123G

Room Air Conditioner & Heat Pump Use and Care Manual

Contents

Introduction.....	1
Safety Information	1
Normal Care & Maintenance	3
Installation Requirements	5
Electrical Requirements.....	6
Installation Instructions	8
General Instructions	11
Operating Controls	12
Troubleshooting.....	14
When Service is Required.....	14
Any Questions	14

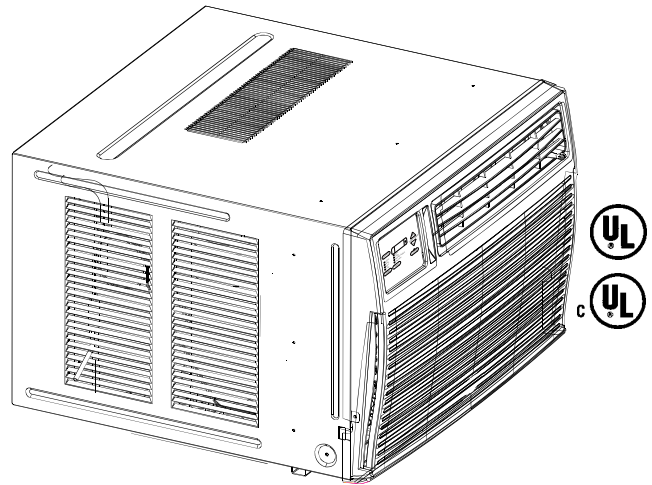

NOTE

1. Mechanical experience is required to install air conditioner.
2. Installation can take from 1 to 3 hours, depending on installer's knowledge and skill.
3. If you encounter problems during installation, call our consumer information line at (517) 787-2100 and ask for the technical service department. If your problem cannot be resolved by phone, contact an authorized servicer.

Introduction

Room air conditioners cool, dehumidify and filter air inside your home. Heat pump models offer both heating and cooling. The opening sections of this manual provides some general information for all room air conditioner models. The Operating Controls section describes operation of controls for each model. After reading the opening sections, turn to the Operating Controls section and find the panel layout that matches your model.

Read entire manual thoroughly before beginning installation and operation of your new room air conditioner. Be sure you have all necessary tools and materials on hand for the job. Study illustrations to familiarize yourself with important details of the installation process. Review manual for operating instructions.

Safety Information

Be sure electrical service is adequate for chosen model of air conditioner. Complete electrical rating for unit is found on serial plate located behind front grille. Electrical outlet must be close enough to unit for power cord to reach without strain. Air conditioner should be the only appliance on individual circuit.

For personal safety and to avoid possible damage to appliance or home, observe all safety instructions highlighted by symbol shown below.



**RECOGNIZE THIS SYMBOL AS A
SAFETY PRECAUTION.**

After installing unit, reread instructions to ensure each step is complete and that all parts are fastened in place. For best results and to minimize installation time, perform all procedures in the order shown.

**WARNING**

To prevent heat related illness or death, do not use this device unattended. Failure of an unattended air conditioner may result in extreme heat in area intended for cooling, causing heat related illness or death of persons or animals.

**WARNING**

HIGH TEMPERATURE STRESS HAZARD
This room air conditioner is not meant to provide unattended cooling or life support for persons or animals that are unable to react to failure of the product.

The failure of an unattended air conditioner may result in extreme heat in the conditioned space causing overheating or death of persons or animals.

Precautions must be taken to ward off or guard against such an occurrence.

Unpacking

Unpack and visually inspect the unit. Report any damage to the delivering carrier immediately. If your unit is not damaged, remove and discard all packing materials.

**WARNING**

Do NOT operate unit with shipping foam blocks in place. Always remove prior to running unit.

On some models the air conditioner front and/or mounting kit hardware may be packed separately.

Record the model and serial numbers of your unit in the space provided. This information is found on a nameplate visible after the front of the air conditioner has been removed. The rated voltage, amperage and capacity for your specific model can also be found on this nameplate. Read the warranty packaged with the unit. Register your unit and keep the warranty and a copy of your sales receipt for future reference. You may also want to record in the space provided the date purchased and the selling dealer.

OWNER'S PRODUCT IDENTIFICATION

MODEL NUMBER _____

SERIAL NUMBER _____

Owner's Name _____

Address _____

City State Zip _____

Date of Purchase _____

Authorized Dealer _____

Address _____

City State Zip _____









()
Phone Number _____**WARNING**

To avoid death, personal injury or property damage due to electrical shock:

- Observe all local codes and ordinances.
- Disconnect electrical power to unit before servicing.
- Ground appliance properly.
- Check with a qualified electrician if you are not sure this appliance is properly grounded.
- DO NOT ground to gas line.
- DO NOT ground to cold water pipe if pipe is interrupted by plastic, non-metallic gaskets, or other insulating (non-conducting) materials.
- DO NOT modify plug on power cord. If plug does not fit electrical outlet, have proper outlet installed by qualified electrician.
- DO NOT have a fuse in the neutral or ground circuit. A fuse in the neutral or ground circuit could result in an electrical shock.
- DO NOT use an extension cord with this appliance.
- DO NOT use an adapter plug with this appliance.
- DO NOT pinch power cord.
- DO NOT REMOVE warning tag from power cord.

Electrical Requirements**Grounding Instructions**

This appliance is equipped with a three-prong grounding plug for protection against possible shock hazards. If a two-prong

Unit Plug Type	Receptacle Required	Circuit Rating, Breaker, Time Delay Fuse	Voltage Rating On Nameplate
NEMA No. 5-15P 	NEMA No. 5-15R 	125V-15AMP	115V
NEMA No. 6-15P 	NEMA No. 6-15R 	250V-15AMP	230/208V rated at 12 amperes or less
NEMA No. 6-20P 	NEMA No. 6-20R 	250V-20AMP	230/208V rated over 12 amperes, but not more than 16 amperes
NEMA No. 6-30P 	NEMA No. 6-30R 	250V-30AMP	208V rated over 16 amperes, but not more than 24 amperes

wall receptacle is encountered, the customer is required to contact a qualified electrician and have the two-prong wall receptacle replaced with a properly grounded three-prong wall receptacle in accordance with the National Electrical Code.

Room air conditioners are designed to operate according to requirements on the nameplate and as shown in Table 1. Fuse or circuit breaker ratings must be according to the fuse instruction label and as shown in Table 1. Do not plug models marked "Use on Single Outlet Circuit Only" into a circuit with another appliance or light fixture.

Receptacle Wiring

Receptacle wiring must be of adequate size for unit. Refer to unit identification plate for exact power requirements. Minimum size of wiring, based on power requirements, is:

Units up to 20 amps: 12 gauge
20–30 amp units: 10 gauge

LCDI or AFCI Power Cords

Underwriters Laboratories (UL) and the National Electric Code (NEC) now require power cords that sense current leakage to be able to open the electrical circuit to the unit. In the event, the unit does not operate, check the reset button located on or near the head of the power cord as part of the normal troubleshooting procedure.

Use copper wire only. Consumer's responsibility is to provide proper and adequate receptacle wiring that conforms to all applicable codes. All wiring should be installed by qualified electrician.

Installation

Complete step-by-step installation instructions are furnished with your unit. These instructions will be found on a separate

page included with this manual or in the mounting kit assembly. Follow these instructions carefully. Keep these instructions with this manual for future reference. Your unit will be one of the following three designs:

- *Unit with a window mounting kit*

These models are designed for mounting through an opening in a wall. These units can be adapted to window installation by using the optional window mounting kit supplied with your unit.

- *Unit without a window mounting kit*

No window mounting kit is supplied with the unit. These models are designed for mounting through an opening in a wall. These units can be adapted to window installation by purchasing an optional window mounting kit. Consult your dealer to choose the kit that is appropriate for your model and installation.

Room Heat Pumps

Heat pumps work by moving heat instead of creating it. In the summer, the cool indoor coil absorbs heat from your room and moves it outdoors, providing cooling. In the winter, heat pumps reverse this operation. By lowering the temperature of the outdoor coil below the outdoor temperature, the heat pump absorbs the heat from outdoors and moves it inside your house. This heat transferring process is very efficient. For example, at 45°F outdoor temperature, a heat pump can provide 2 ½ watts of heat for every watt of electricity it consumes.

As outdoor temperatures drop, the heating capacity and efficiency of the heat pump declines. At temperatures below 45°F, it is likely that ice will form on the outdoor coil. Heat pump units are designed to operate as a heat pump above approximately 40°F. Below 40°F, these units switch automatically from reverse cycle heat pump to auxiliary electric heating. No defrost is required. There is no minimum operating temperature.

Normal Care and Maintenance



WARNING

To avoid property damage, personal injury or death due to electrical shock, turn unit OFF and remove plug from wall outlet before inspecting unit or performing maintenance.

Annual Inspection

It is suggested that your unit be inspected by your dealer or servicer once a year. It is advisable to have the outer case removed and the unit thoroughly cleaned.

Note: The life of your unit may be greatly reduced if you live in a corrosive and/or oceanside location with salty air. Under these conditions, the unit should be removed from its case and completely cleaned at least once a year. At that time any scratches or blisters on the painted surfaces should be sanded and repainted. Placing an algaecide tablet in the outdoor side of the unit's basepan is suggested in humid areas where algae formation is common.

Front Grille and Filter Removal

The front contains an air filter that can be removed on left or right side of front. To clean the filter use one of the following methods for filter removal:

METHOD ONE

Grasp filter handle and slide filter out of unit.

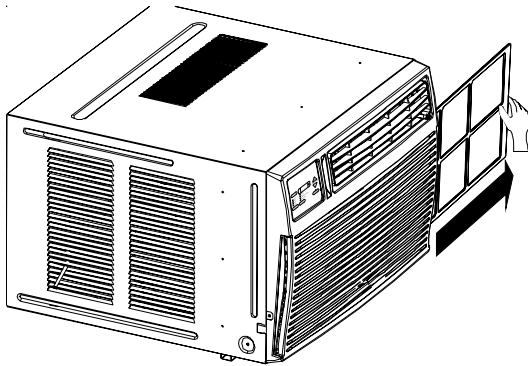

1. Remove two side ground screws attaching case to chassis basepan.
2. Remove two control knobs.
3. Remove two side Phillips screws attaching front panel to case.

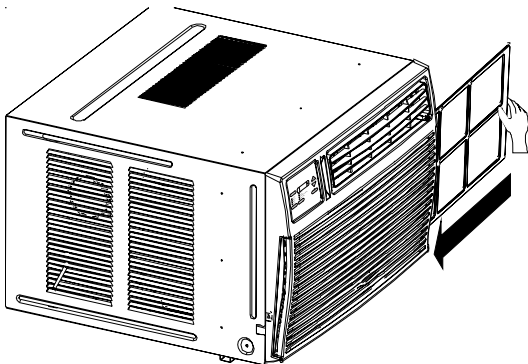

Reinstall air filter by reversing removal procedure.

Front Grille and Cabinet Cleaning

Grille and cabinet may be cleaned with warm water and mild soap or detergent. Cleaning and polishing compounds are not recommended, as they may damage plastic surfaces.

Air Filter Cleaning

A dirty air filter reduces operating efficiency of unit. Filter should be inspected at least once every week during operation. Clean filter with vacuum cleaner or wash in warm water and mild detergent. Filter should be thoroughly dried before replacing in unit. Do not operate unit without filter in place.

Fan Motor Care

The fan motor is permanently lubricated for long life. There is no need to oil the motor.

Slide-out Chassis Removal from Outer Case

4. If the unit has a screw holding the basepan clip to the chassis, remove the screw.

CAUTION

To reduce the risk of personal injury, be sure to have sufficient help when moving your unit. Check the weight of your unit by contacting your dealer.

5. Using basepan handle, pull chassis straight out, slowly and evenly, until approximately 9-12 inches extends from outer case. Use both hands to grasp basepan and pull remaining chassis from outer case.

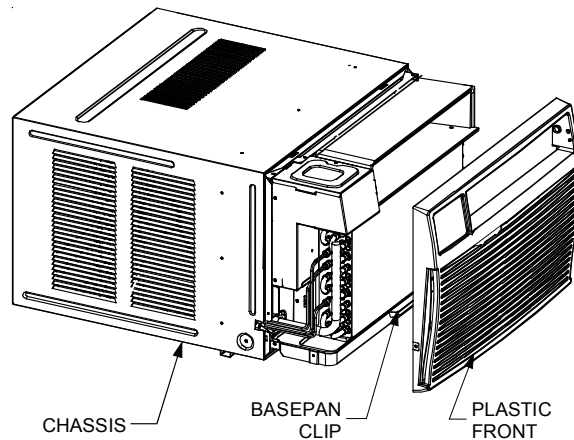

NOTE: Basepan clip is shipped in plastic bag with mounting screw and condensate drain cup. Install clip after reinserting chassis into outer case to prevent accidental chassis removal.

IMPORTANT SAFETY INSTRUCTIONS

WARNING: To reduce the risk of fire, electrical shock or injury when using your air conditioner, follow these basic precautions:

- Plug into a grounded 3 prong outlet.
- Do not use an extension cord.
- Do not remove ground prong.
- Unplug air conditioner before servicing.
- Do not use an adapter.
- Use two or more people to move and install air conditioner.

SAVE THESE INSTRUCTIONS

INSTALLATION REQUIREMENTS**Tools and Parts**

Gather the required tools and parts before starting installation. Read and follow the instructions provided with any tools listed here.

Tools Needed

- Flat-head and Phillips screwdrivers
- Tape measure
- Level
- Drill and $\frac{3}{16}$ " or smaller bit

Through-the-wall installation:

In addition to the tools listed above, the following tools are needed for through-the-wall installation.

- Saw
- 1" or thicker lumber
- Wood preservative
- 7 - #10 x 1" wood screws
- Caulk

Parts supplied (on some models)

Check that all parts are included in parts package.

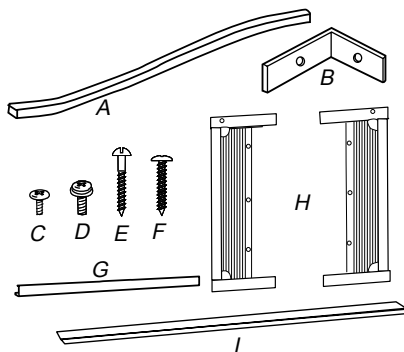

- A. Foam window sash seal
- B. Window lock brackets (2)
- C. #10 x $\frac{1}{4}$ " pan-head Phillips screws (6)
- D. #10 x $\frac{3}{8}$ " pan-head Phillips screws (3)
- E. #10 x $\frac{3}{4}$ " round-head screws (6)
- F. #10 x $\frac{1}{2}$ " pan-head Phillips screws (3)
- G. Top channel
- H. Side curtains (2)
- I. Foam seal

NOTE: Installation parts are supplied for double-hung windows.

Location Requirements

IMPORTANT: Observe all governing codes and ordinances.

Check the location where air conditioner will be installed. Proper installation is your responsibility. Make sure you have everything necessary for correct installation.

The location should provide:

- Grounded electrical outlet within 4 ft of where the power cord exits the air conditioner.

NOTE: Do not use an extension cord.

- Free movement of air in room to be cooled.
- A large enough opening for the air conditioner.
- Adequate wall support for weight of air conditioner. Check the weight of your unit by contacting your dealer.

NOTE: Cabinet louvers must not be obstructed. Air must be able to pass freely through the cabinet louvers.

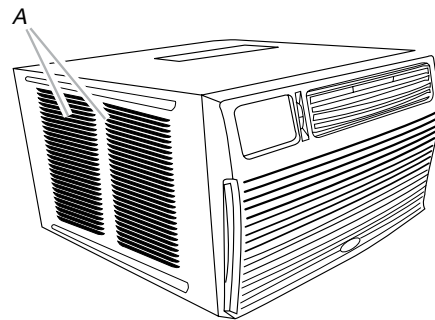

A. Cabinet louvers

Window installation

Window opening measurements:

- 27" min. to 39" max. opening width.
- 16¼" min. opening height.

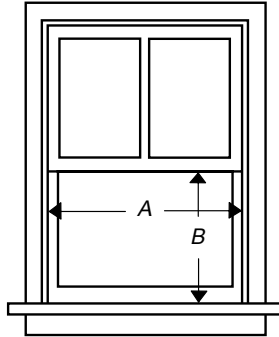

A. 27" min.
B. 16¼" min.

Electrical Requirements

⚠ WARNING



Electrical Shock Hazard

Plug into a grounded 3 prong outlet.

Do not remove ground prong.

Do not use an adapter.

Do not use an extension cord.

Failure to follow these instructions can result in death, fire, or electrical shock.

Ground wire must be connected to ground screw located in lower right corner of air conditioner when air conditioner is in cabinet.

The electrical ratings for your air conditioner are listed on the model and serial number label. The model and serial number label is located behind the front panel on the flange below the control panel area.

Specific electrical requirements are listed in the chart below. Follow the requirements for the type of plug on the power supply cord.

Power supply cord	Wiring requirements
	<ul style="list-style-type: none"> ■ 115-volt (103.5 min. - 126.5 max.) ■ 0-12 amps ■ 15-amp time-delay fuse or circuit breaker ■ Use on single outlet circuit only.
 ¼" (0.6 cm)	<ul style="list-style-type: none"> ■ 230-volt (207 min. - 253 max.) ■ 0-12 amps ■ 15-amp time-delay fuse or circuit breaker ■ Use on single outlet circuit only.
	<ul style="list-style-type: none"> ■ 208/230-volt (198min. - 253 max.) ■ 0-16 amps ■ 20-amp time-delay fuse or circuit breaker ■ Use on single outlet circuit only.
 ½" (1.3 cm)	<ul style="list-style-type: none"> ■ 230-volt (207 min. - 253 max.) ■ 0-24 amps ■ 30-amp time-delay fuse or circuit breaker ■ Use on single outlet circuit only.

Recommended grounding method

This air conditioner must be grounded. This air conditioner is equipped with a power supply cord having a grounded 3 prong plug. To minimize possible shock hazard, the cord must be plugged into a mating, grounded 3 prong outlet, grounded in accordance with all local codes and ordinances. If a mating outlet is not available, it is the customer's responsibility to have a properly grounded 3 prong outlet installed by a qualified electrical installer.

It is the customer's responsibility:

- To contact a qualified electrical installer.
- To assure that the electrical installation is adequate and in conformance with National Electrical Code, ANSI/NFPA 70 - latest edition, and all local codes and ordinances.

Copies of the standards listed may be obtained from:

National Fire Protection Association
One Batterymarch Park
Quincy, MA 02269

Power Supply Cord

NOTE: Your unit's device may differ from the ones shown.

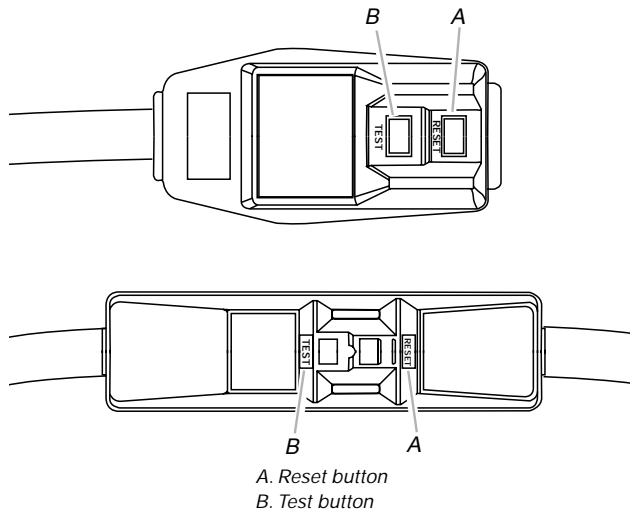

This room air conditioner is equipped with a power supply cord required by UL. This power supply cord contains state-of-the-art electronics that sense leakage current. If the cord is crushed, the electronics detect leakage current and power will be disconnected in a fraction of a second.

WARNING



Electrical Shock Hazard

Plug into a grounded 3 prong outlet.

Do not remove ground prong.

Do not use an adapter.

Do not use an extension cord.

Failure to follow these instructions can result in death, fire, or electrical shock.

To test your power supply cord:

1. Plug power supply cord into a grounded 3 prong outlet.
2. Press RESET.
3. Press TEST (listen for click; Reset button will trip and pop out).
4. Press and release RESET (listen for click; Reset button will latch and remain in). The power supply cord is ready for operation.

NOTES:

- The Reset button must be pushed in for proper operation.
- The power supply cord must be replaced if it fails to trip when the test button is pressed or fails to reset.
- Do not use the power supply cord as an off/on switch. The power supply cord is designed as a protective device.
- A damaged power supply cord must be replaced with a new power supply cord obtained from the product manufacturer and must not be repaired.
- The power supply cord contains no user serviceable parts. Opening the tamper-resistant case voids all warranty and performance claims.

INSTALLATION INSTRUCTIONS

Unpacking

⚠ WARNING

Excessive Weight Hazard

Use two or more people to move and install air conditioner.

Failure to do so can result in back or other injury.

Remove packaging materials

- Remove and dispose of/recycle all packaging materials. Remove tape and glue residue from surfaces before turning on the air conditioner. Rub a small amount of liquid dish soap over the adhesive with your fingers. Wipe with warm water and dry.
 - Do not use sharp instruments, rubbing alcohol, flammable fluids, or abrasive cleaners to remove tape or glue. These products can damage the surface of your air conditioner.
 - Handle air conditioner gently.
1. Remove air conditioner from carton and place it on cardboard.
 2. Remove shipping screws from both sides of cabinet.

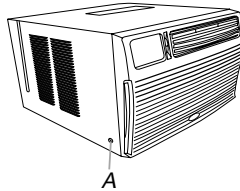

A. Shipping screw

3. Remove front panel by removed 2 phillips screws on both bottom left right sides of front.
3A: Remove both knobs from control panel.
4. Pull on handle to slide air conditioner out of cabinet. Place air conditioner on cardboard.
5. Remove any paking foam from inside of unit.

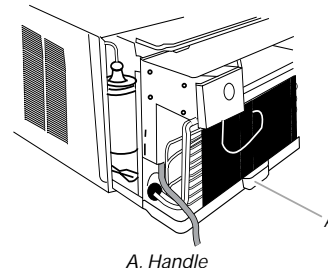

A. Handle

NOTE: Do not lift, push, pull or remove any expanded polystyrene (foam) from inside the air conditioner. It is not packing material.

Window Installation

NOTES:

- Handle air conditioner gently.
- Be sure your air conditioner cabinet does not fall out of the opening during installation or removal.
- The location where the power cord exits the air conditioner should be no more than 4 ft from a grounded 3 prong outlet.
- Do not block the louvers on the front panel.
- Do not block the louvers on the outside of the air conditioner.

Attach Top Channel

NOTE: Attach top channel and side curtains to air conditioner cabinet before placing cabinet in window.

1. Locate supplied bag of screws.
2. Place top channel on top of air conditioner cabinet, lining up the 3 holes in top channel with the 3 holes on top of air conditioner cabinet.

3. Using 3 - #10 x 3/8" pan-head Phillips screws, attach top channel to air conditioner cabinet.

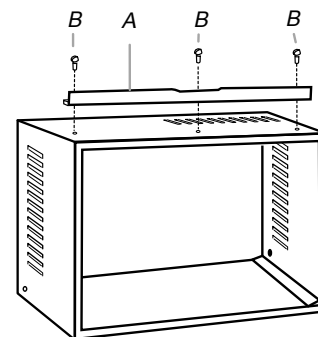

A. Top channel

B. #10 x 3/8" pan-head Phillips screws (3)

Attach Side Curtains

1. Locate provided bag of screws.
2. Insert top and then bottom of right-hand curtain housing in top and bottom curtain guides on air conditioner cabinet.

Back View

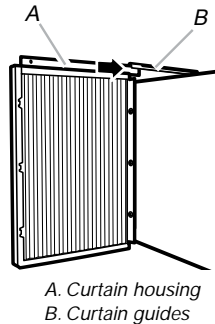

Bottom View

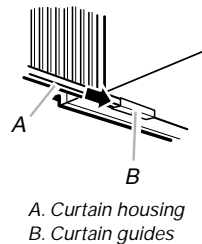

3. Extend right-hand curtain outward so you may insert the first screw through the middle hole of the curtain. Using #10 x 1/4" pan-head Phillips screw, screw curtain to middle hole in air conditioner cabinet.
- NOTE:** This screw is required to correctly attach curtain (top to bottom) to the air conditioner cabinet.

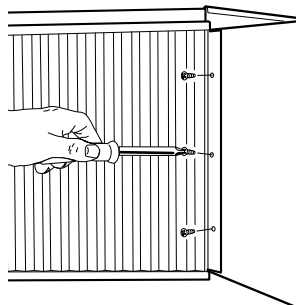

4. While the right-hand curtain is still extended, insert #10 x 1/4" pan-head Phillips screws into the top and bottom slots of curtain. Screw curtain to the top and bottom holes in air conditioner cabinet.
- NOTE:** Some curtains may have 2 slots at each end. You will be able to see a mounting hole through the correct slot.
5. Slide curtain housing into guides as far as it will go.
6. Repeat above steps for left-hand curtain.

Attach foam adhesive seal

Attach foam adhesive seal along the bottom of the curtain bottom channel.

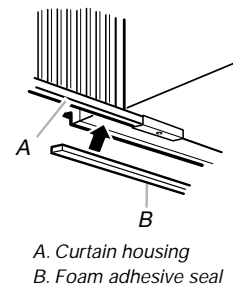

Install Cabinet into Window

- Handle air conditioner gently.
- Be sure your air conditioner cabinet does not fall out of the opening during installation or removal.
- The location where the power cord exits the air conditioner should be no more than 4 ft from a grounded 3 prong outlet.
- Do not block the louvers on the front panel.
- Do not block the louvers on the outside of the air conditioner.

1. Center empty cabinet in window. Check that lower rail of air conditioner cabinet is behind and against back side of windowsill. Maintain a firm hold on the air conditioner cabinet. Lower window sash to hold cabinet in place. Top channel must be on inside room of window sash.

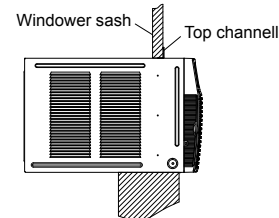

2. Measure the distance between the right-hand side of the cabinet and the inside of the window channel.
3. Repeat for the left side. Adjust the cabinet until the distance on each side is the same.

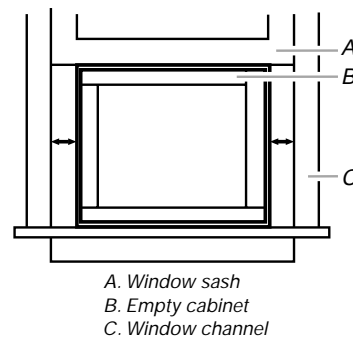

- Use a $\frac{3}{16}$ " drill bit to drill 3 starter holes $\frac{1}{2}$ " deep through the 3 holes in the cabinet and into the windowsill.
- Attach cabinet to windowsill with 3 - #10 x $\frac{1}{2}$ " pan-head Phillips screws.

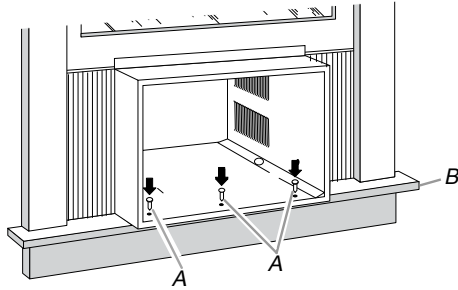

A. #10 x $\frac{1}{2}$ " pan-head Phillips screws
B. Windowsill

- Check that air conditioner cabinet is tilted $\frac{1}{2}$ bubble on carpenter's level to the outside so that water will run to the outside.

Attach Side Curtains to Window Frame

- Pull left-hand curtain out until it fits into window channel. Use a $\frac{3}{32}$ " drill bit to drill a starter hole through the hole in the curtain housing and into the lower window sash.

Front View

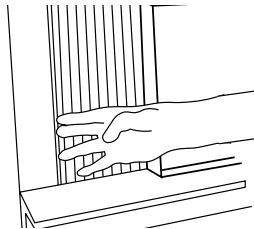

Top View

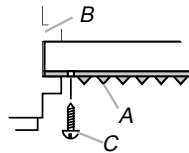

A. Left-hand curtain
B. Window channel
C. #10 x $\frac{3}{4}$ " round-head screw

- Insert one of the #10 x $\frac{3}{4}$ " round-head screws through hole and into lower window sash. Insert one of the #10 x $\frac{3}{4}$ " round-head screws through threaded hole in top of curtain and one in bottom of curtain.

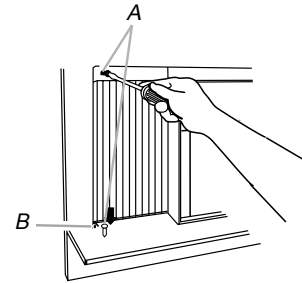

A. #10 x $\frac{3}{4}$ " round-head screw
B. Hole for #10 x $\frac{3}{4}$ " round-head screw

- Repeat for right-hand curtain.

Complete Window Installation

- Insert foam seal behind the top of the lower window sash and against the glass of the upper window.
- Place window-lock bracket on top of lower window and against upper window sash.
- Use a $\frac{3}{32}$ " drill bit to drill a starter hole through the hole in the bracket and into the window sash.
- Attach window-lock bracket to window sash with #10 x $\frac{3}{4}$ " round-head screw to secure window in place.

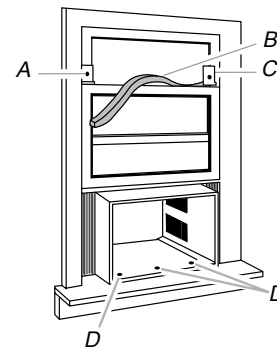

A. Window lock bracket(2) C. Upper window glass
B. Foam seal D. #10 x $\frac{1}{2}$ " pan-head Phillips screws (3)

General Operating Instructions

While operation of all units is similar, controls vary slightly from model to model. *Operating Controls* section shows control panel of unit purchased and gives detailed information about operation of controls.

Airflow Around Unit

Select the highest fan speed and set temperature control to its coldest position. When the desired temperature is reached, slowly move the temperature control toward a warmer setting until the compressor shuts off. The thermostat will then cycle the compressor on and off to maintain this selected temperature. Adjust the fan speed for desired air circulation.

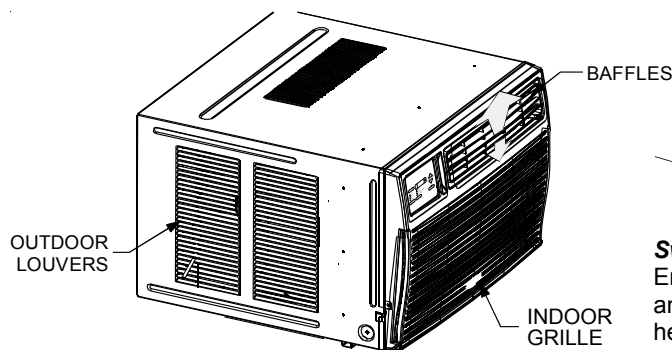

Changing Airflow Direction Baffles

Airflow on unit may be diverted left or right from center by baffles. Upward and downward air discharge is provided by tilting louvers. Adjust baffles and tilt louvers for desired airflow pattern.

Airflow Around Unit

Check the indoor grille and outdoor louvers for obstructions to airflow. Do not block the airflow to and from the unit. If air is obstructed and/or deflected back into the unit, the air conditioner's compressor may cycle on and off rapidly. This could damage your unit.

Drain Cup Installation and Use

Your air conditioner uses a system where the water removed from the indoor air (condensate) is channeled to the outdoor side of the unit. The outdoor fan blade has a "slinger" ring attached to it that dips into the water and slings the water onto the outdoor coil surface. This is the sound of water you hear during normal operation. The water quickly evaporates on this warm surface and improves the efficiency of your air conditioner. In normal conditions the unit can evaporate the water as fast as it is removed from the indoor air.

However, in very humid conditions excess amounts of water may drip off the unit chassis. If this proves to be a problem, install the condensate drain cup included with the unit to route excess water where it would not be a problem (see illustration).

To install, remove the unit chassis from the outer case. Insert the condensate drain cup through the recessed 1/2" hole on the back center of the outer case. Once inserted, place a 1/2" diameter hose or tube on the drain cup bottom spout. The hose allows you to route where you want the excess water to go. Reinsert the unit chassis into the outer case. The unit basepan overflow hole will be positioned directly above the drain cup and will catch any water that might run out.

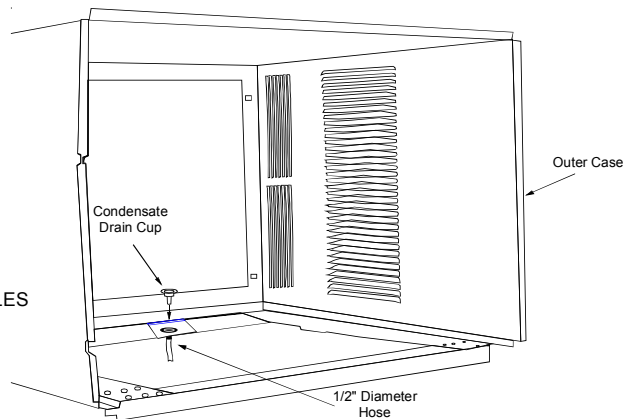

Switchover Thermostat Control

Emergency heat switch overrides heat pump (compressor) and starts auxiliary electrical heater. When switch is ON, heat pump is locked out.

- Use emergency switch *only* when heat pump fails to provide adequate heat. Cause of heat pump malfunction should be determined by authorized servicer. Cost of operating unit will increase when emergency heat switch is engaged.

Only for Qualified Service Personnel

To access and engage emergency switch:

- Unplug unit.
1. Remove front grille, air filter, and plastic front, as described in Installation Instructions.
 2. Slide chassis out of case about two inches.
 3. Locate access hole for emergency switch above label on right front of control box.
 4. Remove control panel for access.
 5. Remove outdoor thermostat from control box and locate "flat head" adjustment screw on back of thermostat.
 6. To start emergency heat, insert flathead screwdriver into slot and turn *counterclockwise* until switch-stop is reached.
 7. Return chassis to case.
 8. Re-install thermostat and mount control panel door.
 9. Replace plastic front, air filter, and front grille.

Operating Controls (For Electronic units)

Operating your air conditioner properly helps you to obtain the best possible results.

This section explains proper air conditioner operation.

IMPORTANT:

- If you turn off the air conditioner, wait at least 3 minutes before turning it back on. This prevents the air conditioner from blowing a fuse or tripping a circuit breaker.
- Do not try to operate your air conditioner in the cooling mode when outside temperature is below 61°F (16°C). Do not try to operate your air conditioner in the heating mode when outside temperature is over 86°F (30°C). Otherwise, the inside evaporator coil will freeze up, and the air conditioner will operate properly.

NOTE: In the event of a power failure, your air conditioner will operate at the previous settings when the power is restored.

Lights next to the touch pads on the air conditioner control panel indicate the selected settings.

The display shows the set temperature when in Heat/Cool/Energy Saver mode. Shows time remaining on the delay timer. Shows the room temperature when in Fan Only mode.

Light indicates the unit is in the temperature or delay time Set mode.

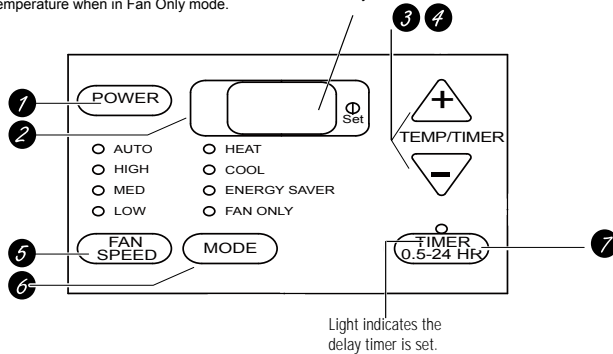

Air Conditioner Controls

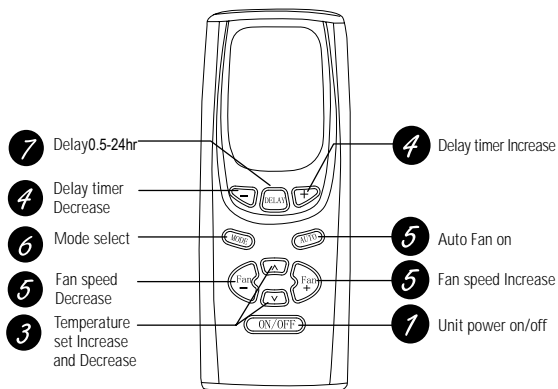



Remote Control



Controls

- 1 Power Pad**
Turns air conditioner on and off.
- 2 Display**
Shows the set temperature when in Heat/Cool/Energy Saver mode. Shows time remaining on the delay timer. Shows the room temperature when in Fan Only mode. The Set light will turn on while setting.
- 3 Temp Increase ▲ /Decrease ▼ Pads**
Use to set temperature when in Heat (on some models) /Cool/Energy Saver. The Set light will turn on while setting. Press Increase (+) and Decrease (-) Pads at the same time for 3 seconds, Temperature display will change between °F and °C.
- 4 Timer/Delay Increase ▲ (+) /Decrease ▼ (P) Pads**
Each touch of the Increase ▲ /Decrease ▼ pads on the unit or the Increase + /Decrease - pads on the remote control will set the delay time when using the Delay 0.5-24hr timer. The Set light will turn on while setting.
- 5 Fan Speed Pads**
Use to set the fan speed to Low, Med, High or Auto on the unit. **NOTE:** On the remote control, use the fan speed Increase + /Decrease - pads to set the fan speeds to Low, Med or High. Use the Auto pad to turn Auto fan on.
- 6 Mode Pad**
Use to set the air conditioner to Cool, Energy Saver, Fan Only or Heat (on some models) mode.
- 7 Timer/Delay Pads**
Timer/Delay On—When the air conditioner is off, it can be set to automatically come on in 0.5 to 24 hours at its previous mode and fan settings.

Timer/Delay OFF—When the air conditioner is on, it can be set to automatically turn off in 0.5 to 24 hours.

How to set:

Press the **Timer 0.5–24hr** pad on the unit or the   pad on the remote control. Each touch of the **Increase ▲ / Decrease ▼** pads on the unit or the **Increase + / Decrease –** pads on the remote control will set the timer in 0.5 hour or 1 hour intervals (the intervals is 0.5 hour as the delay timer below 10 hours; the intervals is 1 hour as the delay timer above 10 hours) The **Set** light will turn on while setting.

To review the remaining time on the **Timer 0.5–24hr** timer, press the **Timer 0.5–24hr** pad on the unit or the   pad on the remote control. Use the **Increase ▲ / Decrease ▼** pads on the unit or the **Increase + / Decrease –** pads on the remote control to set a new time if desired. **To cancel the timer**, press the **Timer 0.5–24hr** pad until the light on the **Timer 0.5–24hr** pad goes off.

Remote Control

- To ensure proper operation, aim the remote control at the signal receiver on the air conditioner.
- The remote control signal has a range of up to 20 feet.
- Make sure nothing is between the air conditioner and the remote control that could block the signal.
- Make sure batteries are fresh and installed correctly as indicated on the remote control.

Cool Mode

Use the **Cool** mode at **Low, Med, High** or **Auto Fan Speed** for cooling. Use the **Temperature Increase ▲ / Decrease ▼** pads to set the desired temperature between 61°F and 86°F in 1°F increments.

The compressor will cycle on and off to keep the room at the set level of comfort. Set the thermostat at a lower number and the indoor air will become cooler. Set the thermostat at a higher number and the indoor air will become warmer.

NOTE: If the air conditioner is off and is then turned on while set to a **Cool** setting or if turned from a fan setting to a **Cool** setting, it may take approximately 3 minutes for the compressor to start and cooling to begin. This time delay is required to protect the compressor.

Cooling Descriptions

For Normal Cooling—Select the **Cool** mode and **High** or **Med** fan with a middle set temperature.

For Maximum Cooling—Select the **Cool** mode and **High** fan with a lower set temperature.

For Quieter & Nighttime Cooling—Select the **Cool** mode and **Low** fan with a middle set temperature.

Energy Saver Mode

Controls the fan.

ON—The fan will cycle on and off with the compressor. This results in wider variations of room temperature and humidity. Normally used when the room is unoccupied. **NOTE:** The fan may continue to run for a short time after the compressor cycles off.

OFF—The fan runs all the time, while the compressor cycles on and off.

Fan Only Mode

Use the **Fan Only** Mode at **Low, Med** or **High** fan speed to provide air circulation and filtering without cooling. Since fan only settings do not provide cooling, a **Set** temperature cannot be entered. The room temperature will appear in the display.

NOTE: Auto Fan Speed cannot be used when in the **Fan Only** Mode.

Heat Mode (On some models)

Use the **Heat** mode at **Low, Med, High** or **Auto Fan Speed** for heating. Use the **Temperature Increase ▲ / Decrease ▼** pads to set the desired temperature between 61°F and 86°F in 1°F increments.

Auto Fan Speed

Set to **Auto** fan speed for the fan speed to automatically set to the speed needed to provide optimum comfort settings with the set temperature. If the room needs more cooling, the fan speed will automatically increase. If the room needs less cooling, the fan speed will automatically decrease.

NOTE: Auto Fan Speed cannot be used when in the **Fan Only** Mode.

Power Outage Recovery Feature

In the case of a power outage or interruption, the unit will automatically re-start in the settings last used after the power is restored. If the **Timer/Delay 0.5-24hr** feature was set, it will resume countdown. You may need to set a new time if desired.

Troubleshooting



WARNING

To reduce the risk of electric shock, personal injury, or death, turn the fan control to the off position and remove the unit plug from the wall outlet before doing any inspection or maintenance work.

The following is a list of problems that are sometimes encountered when using a room air conditioner. Possible cause and suggested remedies are given for each problem.

If the problem cannot be fixed using the suggested remedies, see *WHEN SERVICE IS REQUIRED* section.

PROBLEM	POSSIBLE CAUSE	SUGGESTED REMEDY
UNIT WILL NOT RUN	No power to unit	Push reset button on power cord. Set Fan Control to any position other than OFF. Make sure plug is firmly seated in outlet. Check for blown fuses, tripped circuit breakers.
LITTLE OR NO COOLING LITTLE OR NO HEATING (fan <i>and</i> compressor run)	Obstructed indoor or outdoor airflow Dirty air filters Unit undersized for application	Remove obstruction from indoor grille or outdoor louvers. Dirty air filter. Clean or replace, as needed. Check with dealer to determine proper capacity unit for application.
LITTLE OR NO COOLING LITTLE OR NO HEATING (only fan runs)	Temperature Control not set properly	For cooling, turn Temperature Control to cooler setting. For heating, turn Temperature Control to warmer setting.
NOISY UNIT	Front panel may be loose Weak building construction Water hitting fan blade Unit oversized for application: compressor cycles on and off frequently	Tighten any loose parts. Provide additional support for unit. Normal in high humidity. Stop noise by removing drain plug or adding condensate drain cup. Check with dealer to determine proper capacity unit for application.
MOUNTING SUPPORT NOT INSTALLED	Storm window frame installed in window	Some models require removal of storm window frame before installation.
FROST ON INDOOR COIL	Dirty air filter Normal for low outdoor temperatures	Clean air filter by vacuuming or washing with water and mild soap. Turning Temperature Control to warmer setting reduces occurrence and duration of frost.
FROST ON OUTDOOR COIL (heat pump models only)	Normal for outdoor temperatures at or below 45°F	Call for service <i>only</i> if unit does not heat room and you have checked all problems and remedies listed under LITTLE OR NO HEATING.
ODORS IN COOLING	Mold, mildew, or algae formation on wet surfaces	To reduce algae growth, use algaecide tablet in base pan; remove drain plug; add condensate drain cup and hose. Thoroughly clean unit.
ODORS IN HEATING	Normal for first time electric heater is used each season	Caused by dust accumulation during unused months. Odor dissipates quickly with heater use.

When Service Is Required

Call 866-557-1865 for service and warranty. Help them give you prompt service by providing:

- An accurate description of problem.
- Complete model and serial number from serial plate
- Proof of purchase (sales receipt) upon request.

Repair by unauthorized servicer that results in subsequent failure of unit voids warranty. Warranty details are contained in warranty certificate enclosed with unit.

Keep accurate records of service calls, including what was done, servicer's name, and date of service.

Any Questions?

Most questions can be answered by your local dealer. If you have other matters that cannot be resolved locally, or you need additional information regarding other heating and cooling products offered by us - please call:

Heat Controller, Inc.
Customer or Technical Service Department
517-787-2100

Design, material, performance data and components
subject to change without notice.

HEAT CONTROLLER, INC.

1900 Wellworth Ave., Jackson, MI 49203 • Ph. 517-787-2100 • Fax 517-787-9341

THE QUALITY LEADER IN CONDITIONING AIR

www.heatcontroller.com

Free Manuals Download Website

<http://myh66.com>

<http://usermanuals.us>

<http://www.somanuals.com>

<http://www.4manuals.cc>

<http://www.manual-lib.com>

<http://www.404manual.com>

<http://www.luxmanual.com>

<http://aubethermostatmanual.com>

Golf course search by state

<http://golfingnear.com>

Email search by domain

<http://emailbydomain.com>

Auto manuals search

<http://auto.somanuals.com>

TV manuals search

<http://tv.somanuals.com>