



H-IM-68

March 2000

Part No. 25001301

Replaces H-IM-44

Direct Drive Fluid Coolers

Installation and Maintenance Data

Table of Contents

Inspection		Mixing Glycol and Water	
System Warranty		Glycol Sludge Prevention	
Installation	2	Fluid Circulating Pump	8
Rigging Instructions	3	Start-up	
Internal Volume and Weight	4	Space and Location Requirements	9-10
Electrical Wiring	4-6	Typical Piping	
System Installation		In-Warranty Return Material Procedure.....	11
Piping Installation		Replacement Parts	12
Glycol Charge	7		

Inspection

Responsibility should be assigned to a dependable individual at the job site to receive material. Each shipment should be carefully checked against the bill of lading. The shipping receipt should not be signed until all items listed on the bill of lading have been accounted for.

Check carefully for concealed damage. Any shortage or damages should be reported to the delivering carrier.

System Warranty

This equipment is designed to operate properly and produce rated capacity when installed in accordance with accepted industry standards. Failure to meet the following conditions may result in voiding of the system warranty:

1. System piping must be installed following industry standards for good piping practices.
2. System must be thoroughly leak checked before initial charging.
3. Power supply to system must meet the following conditions:
 - a. Voltage for 208/230 motors not less than 195 volts or more than 253 volts.
 - b. All other voltages must not exceed +/- 10% of nameplate ratings.
 - c. Phase imbalance not to exceed 2%.
4. All controls and safety switch circuits properly connected per wiring diagram.
5. Factory installed wiring must not be changed without written factory approval.

Installation

NOTE: Installation and maintenance to be performed only by qualified personnel who are familiar with local codes and regulations, and experienced with this type of equipment.

CAUTION: Sharp edges and coil surfaces are a potential injury hazard. Avoid contact with them.

Unit Location

Units are designed for outdoor application and may be mounted on a roof or concrete slab (ground level installation). Roof mounted units should be installed level on steel channels or an I-beam frame to support the unit above the roof. Use of vibration pads or isolators is recommended. The roof must be strong enough to support the weight of the unit. Concrete slabs used for unit mounting should be installed level and be properly supported to prevent settling. A one-piece concrete slab with footings extending below the frost line is recommended.

The dry cooler should be located far enough away from any wall or other obstruction to provide sufficient clearance for air entrance. Do not attach ductwork to the coil inlet or fan outlet. Care should be taken to avoid air recirculation conditions that can be caused by sight screening, walls, etc. Also keep unit fan discharge away from any building air intakes. See page 10 for space and location requirements.

Sound Vibration

Units should be installed away from occupied spaces and above or outside of utility areas, corridors and auxiliary spaces to reduce the transmission of sound and vibration to occupied spaces. The refrigerant piping should be flexible enough to prevent the transmission of noise and vibration from the unit into the building. If the refrigerant lines are to be suspended from the structure of the building, isolation hangers should be used to prevent the transmission of vibration. Where piping passes through a wall, it is advisable to pack fiberglass and sealing compound around the lines to minimize vibration and retain flexibility in the lines.

The unit needs to be secured in its final location. Holes are provided in the base runner for this purpose.

WARNING: There may be more than one source of electrical current in this unit. Do not service before disconnecting all power supplies.

Figure 1. Rigging Instructions.

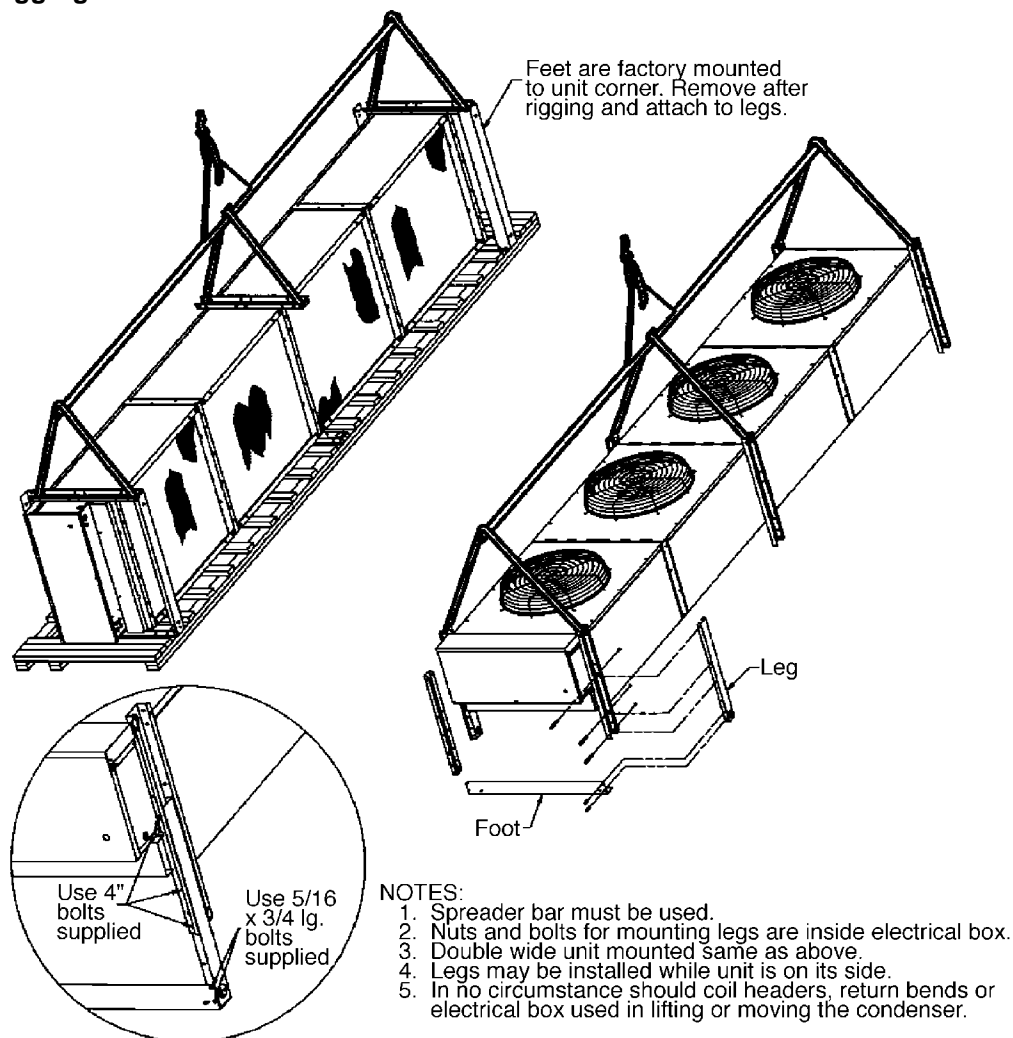

Vertical airflow type units should be located no closer than the width of the unit from a wall or other obstruction. If two or more units are to be positioned in the same area, a

similar distance should be maintained between adjacent units. Sufficient free area should be left around and below unit to avoid air restriction to coil.

Table 1. Fluid Cooler Internal Volume and Weight

Fluid Cooler Fan Configuration	Number of Fans	Number of Rows	Internal Volume Gallons	Approximate Net Weight (Lbs.)
1 x 2	2	2	6.7	1540
1 x 2	2	3	9.2	1590
1 x 2	2	4	11.8	1600
1 x 3	3	3	13.0	2360
1 x 3	3	4	16.7	2420
1 x 4	4	3	16.7	3150
1 x 4	4	4	21.7	2190
1 x 5	5	3	20.4	3510
1 x 5	5	4	26.6	3990
1 x 6	6	4	31.6	4790
2 x 2	2	2	13.5	1540
2 x 2	2	3	18.5	1620
2 x 2	2	4	23.5	1760
2 x 3	3	3	25.9	2420
2 x 3	3	4	33.4	2480
2 x 4	4	3	33.3	3230
2 x 4	4	4	43.3	3510
2 x 5	5	3	40.7	4040
2 x 5	5	4	53.1	4390
2 x 6	6	4	63.1	5270

Electrical Wiring

The electrical installation should be in accordance with National Electrical Code, local codes and regulations. Proper overcurrent protection should be provided for the fan motors. Wiring diagrams shown are only basic and do not show fuses, disconnect switches, etc., which must be provided in the field.

All standard motors have internal inherent overload protectors. Therefore, contactors can be used instead of starters requiring thermal protectors, eliminating the problem of furnishing the proper heating elements.

All dry coolers or units are furnished with either single-phase or three-phase fan motors which are identified by the unit dataplate.

Electrical leads from each motor terminate at the unit junction box. Field connections must be made from these leads through a contactor, fuse and disconnect in accordance with local, state and national codes.

Three-phase motors must be connected to three-phase power of voltage to agree with motor and unit dataplate.

The motors are wired into a common junction box. The motors must be checked for proper rotation. Be sure to check that motor voltage and control connection agree with electric services furnished.

Diagram 1. Typical Fluid Cooler Wiring Diagram Without Fan Cycle Controls.

Single Row of Fans

USE COPPER CONDUCTORS ONLY

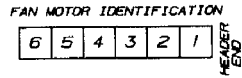

LEGEND:
M1-M6 FAN MOTOR

- NOTE:
1. UNIT MUST BE GROUNDED
 2. TO BE FIELD FUSED, REFER TO UNIT DATA PLATE FOR VOLTAGE.
 3. ALL MOTORS ARE INHERENTLY PROTECTED.
 4. USE 60° C WIRE.

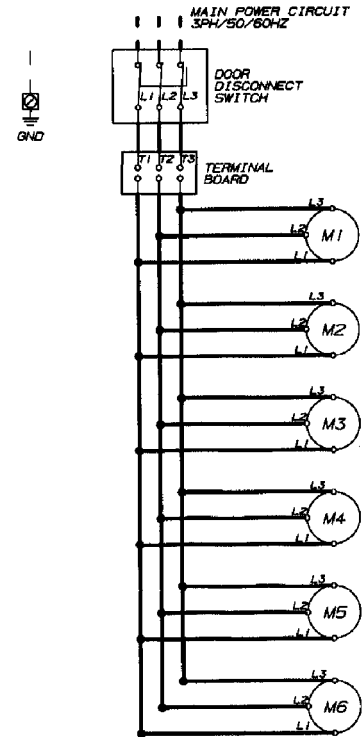

Double Row of Fans

USE COPPER CONDUCTORS ONLY

LEGEND:
M1-M12 FAN MOTOR

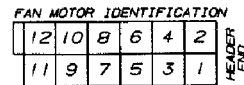

- NOTE:
1. UNIT MUST BE GROUNDED
 2. TO BE FIELD FUSED, REFER TO UNIT DATA PLATE FOR VOLTAGE.
 3. ALL MOTORS ARE INHERENTLY PROTECTED.
 4. USE 60° C WIRE.

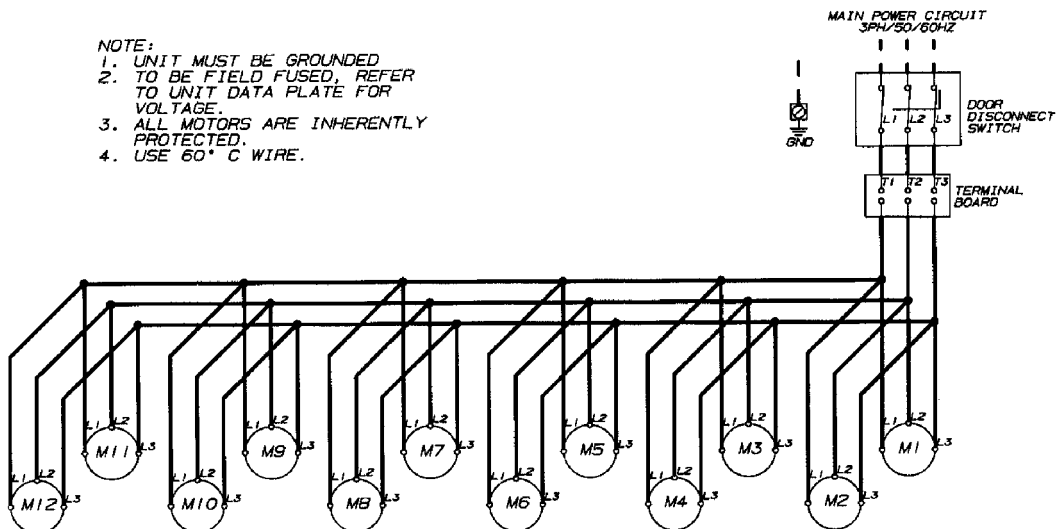
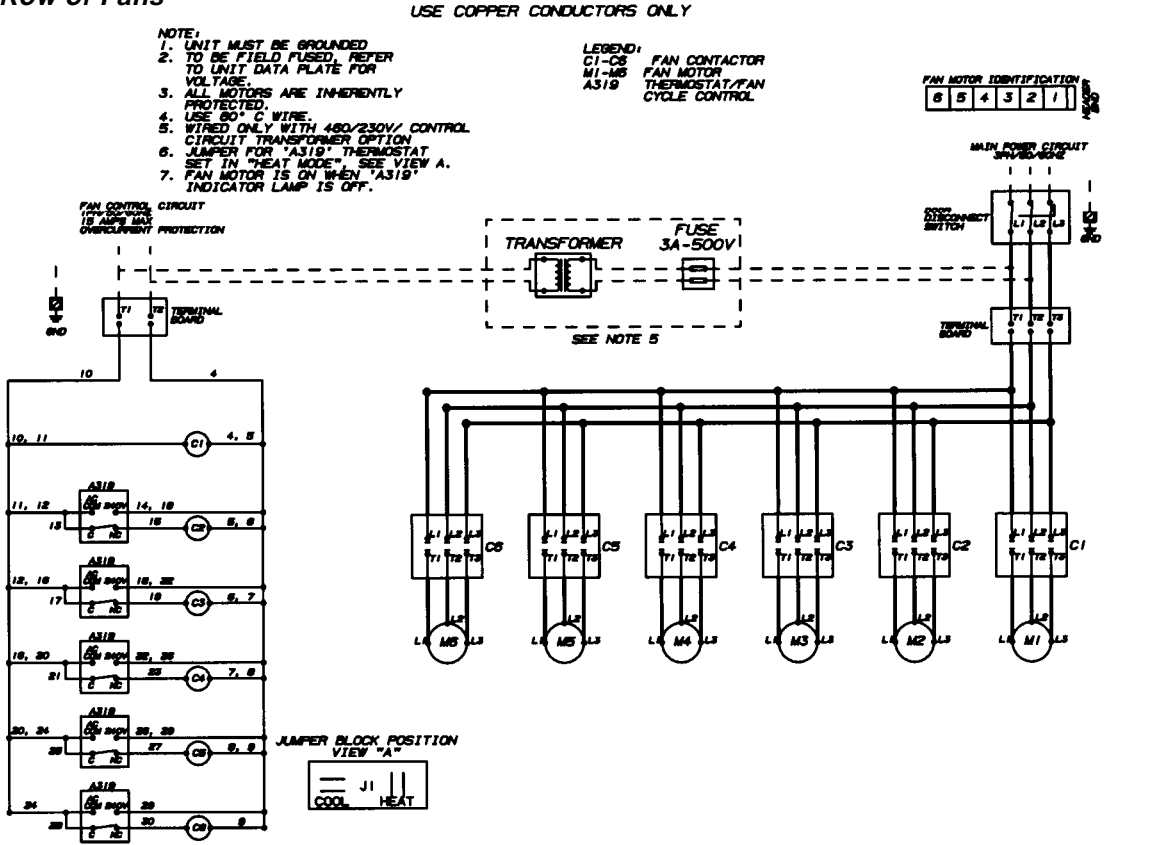
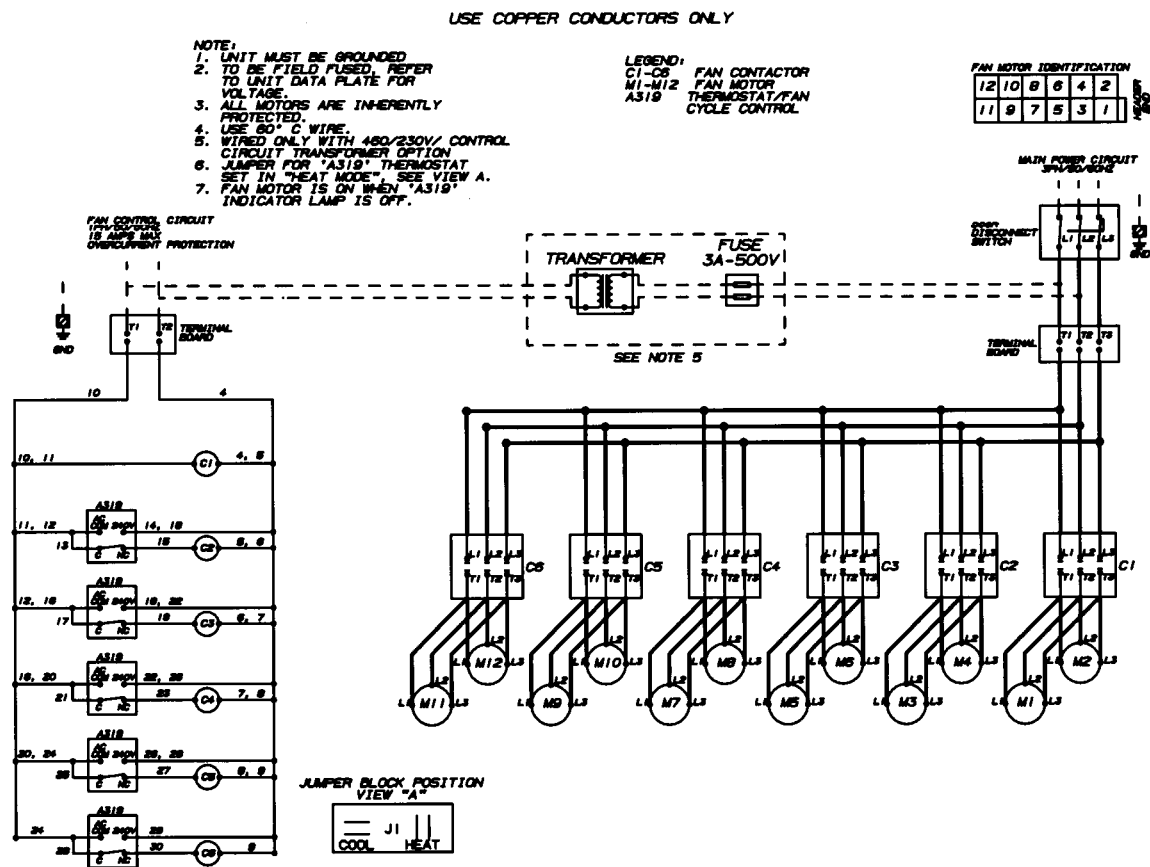

Diagram 2. Typical Fluid Cooler Wiring Diagram With Standard Fan Cycle Controls.

Single Row of Fans



Double Row of Fans



System Installation

NOTE: All installation and maintenance are to be performed only by qualified personnel who are familiar with local codes and regulations, and experienced with this type of equipment. **CAUTION:** Sharp edges and coil surfaces are a potential injury hazard. Avoid contact with them.

General

- Structure supporting unit must be designed to support both the unit and the fluid. Table 2 provides weight of fluid per gallon. Tables 3 and 4 provide unit weight and volume data. Provide suitable flashing of the roof, if this is a roof installation. For ground level mounting, a concrete pad is recommended. Mounting holes permit the unit to be bolted down to withstand wind pressures. Provide adequate clearance for unobstructed air flow to coils. See page 2 for Space and Location requirements.
- Level mounting is necessary to assure proper fluid distribution through the coil as well as flooded suction for the pump.

Table 2. Fluid Weight Per Gallon

Percent Glycol	Pounds Per Gallon
0 (Water)	8.345
10	8.395
20	8.495
30	8.604
40	8.712
50	8.804

- Water piping must comply with local codes. Correct pipe sizing will help reduce pumping power and operating costs.
- In case of doubt, consult the manufacturer for the dry cooler fluid pressure drop at the specific conditions on your job.
- Provide sufficient valves and unions to permit easy access to parts subject to wear and possible repair or replacement.
- After fluid piping is completed, all joints should be leak tested.
- Where city water makeup is required, follow local codes, making certain that disconnecting provisions are provided.
- Select wire in accordance with nameplate data and local codes.

Piping Installation

The piping system should provide maximum leak prevention. Weld or sweat joints should be used where possible or tightly drawn Teflon tape threaded pipe joints should be made if needed. The fact that glycol solutions or other heat transfer fluids will leak where water will not, must be taken into account.

The glycol system should not employ a pressure reducing valve. This is because a slight leak would lead to dilution

of the mixture. Any refill should be controlled so as to maintain the proper glycol-to-water ratio.

Table 3 shows pressure drops for various pipe sizes at flow rates commonly used with a typical dry cooler. These pipe sizes are not necessarily always correct for the run from the condenser to the dry cooler. Proper pipe size will depend on available pump head. This can be determined by subtracting from the total available pump head at design flow, the condenser pressure drop and the dry cooler pressure drop. Allow some safety factor for last minute pipe fittings added to the system and for eventual fouling of the system.

- Glycol piping requires no insulation except when fluid temperature will be below ambient dewpoint temperatures. Dry coolers normally produce about 70° or higher fluid temperatures.
- Vents are required at all high points in the piping to bleed air when filling the system. If fluid coolers are at high points, vent valves should be installed at each fluid cooler.
- It is recommended that gate valves be installed on both sides of the pump to prevent loss of fluid in the event the pump should require repair or replacement. Shut-off valves are also recommended at water cooled condensers in case the condensing unit is to be moved or requires maintenance involving the coolant system.

Table 3. Pressure Loss in Feet of Water

Flow GPM	Pipe Size Steel	Type "L" O.D. Copper	Schedule 40 Steel Head Ft./100 Ft. Equiv. Length	Copper Tube Head Head Ft./100 Ft. Equiv. Length
15	1	1 1/8	17.6	15.0
20	1	1 1/8	30.2	23.1
25	1	1 1/8	—	34.6
25	1 1/4	1 3/8	11.5	12.6
30	1 1/4	1 3/8	16.3	17.4
35	1 1/4	1 3/8	21.8	23.0
40	—	1 3/8	—	26.3
40	1 1/2	1 5/8	13.0	12.9
45	1 1/2	1 5/8	16.5	15.7
60	—	1 5/8	—	26.3
60	2	2 1/8	7.9	7.0
80	2	2 1/8	13.7	12.0
100	2 1/2	2 5/8	8.5	6.1
150	2 1/2	2 5/8	18.6	12.9
200	3	3 1/8	10.7	9.1
250	3	3 1/8	16.5	13.7
300	3 1/2	3 5/8	11.1	9.2
300	4	4 1/8	5.9	4.9
350	4	4 1/8	7.9	6.5
400	4	4 1/8	10.2	8.2

Glycol Charge

The amount of ethylene glycol required depends upon the following:

- The holding volume of the system which includes the holding capacity of the condenser, the holding capacity of the interconnecting piping (Table 3) and the holding capacity of the dry cooler (see Table 3).
- Percentage of glycol required by volume to provide protection at the design minimum outside temperature (see Table 2).

Table 4. Percentage of Ethylene Glycol to be Added by Volume.

Percent %	20%	30%	40%	45%	50%
Minimum Outside Design Temperature °F	+15	-3	-14	-23	-38

Table 4 is intended to be used as a guide only. Proper precautions need to be taken to prevent freeze damage during low ambients. Consult glycol vendor recommendations for specific freeze protection for your location.

Mixing Glycol and Water

Regardless of the strength of the mixture, you **MUST** pre-mix the glycol and water prior to adding it to the system. The chemical reaction between the two will release oxygen, which is extremely undesirable in a close-loop system.

WARNING: For dry coolers operating without glycol mixture, adequate freeze protection is necessary during ambients below 32° F.

Glycol Sludge Prevention

Glycol systems may be subject to sludge formation in coils, due to one or more of the following causes:

1. Reaction of the corrosion inhibitor with galvanized piping (zinc).
2. Reaction of the glycol with chromate type water additives.
3. Reaction of the glycol with pipe dope, cutting oils, solder flux, and other system dirt.

Glycol manufacturers offer a specially inhibited glycol (formulated for snow melting systems) which does not react with zinc. This glycol is also suitable for heat transfer systems. Glycol manufacturers also provide inhibitor check services on a regular basis.

Consequently, good glycol system design requires the following precautions:

1. No galvanized piping is to be used.
2. System piping must be thoroughly cleaned and flushed with a heated trisodium phosphate solution before filling with the water/glycol mixture.
3. No chromate inhibitor treatment must be used.
4. The glycol manufacturer should provide inhibitor check service and supply additional inhibitor as required.

Fluid Circulating Pump

Mechanical seal type pumps must be used for glycol systems. Gland type pumps would cause glycol waste and, if used with a pressure reducing valve, will lead to dilution of the glycol mixture and eventual freeze-up.

Pump is selected for piping friction loss plus fluid pressure drop through the dry cooler coil, plus pressure drop through the heat source. *No allowance for vertical lift* is made since in a closed system a counterhead acts on the pump suction.

With glycol solution the pump performance curve will drift to the right from its design point, due to differences in circuit design, control valve application, pressure drop calculations, etc. The pump should be selected high on the curve so as to provide for the "drift". The pump curve should be "flat" so that the pump will compensate for our inability to exactly predict the final operating system flow condition and to provide sufficient flow for satisfactory heat transfer and maximum protection against freezing at the far end of the circuit. The pump motor should have sufficient power for operating over the entire pump curve to prevent motor overload at reduced voltages. Paralleled pumps can also be used for good power economy and continuous and automatic standby operation. Properly applied parallel pumps will guard against system breakdown caused by a simple pump failure. Certain older systems have nonoperating standby pumps of equal capacity to the operating unit. We recommend parallel pumps in continuous operation because they provide practically the same type of standby, in addition to being completely automatic, at lower initial and operating cost.

Start-up

1. Prestart:

Check for correct dry cooler fan rotation. This can be done by quickly jogging the fan contactor. Be sure that the fans run freely. The same check is recommended for pumps.

2. Filling and Purging the System

The system should be pressure tested before adding glycol. The system can be tested with air or water, however if the ambient temperature is at or below freezing the use of air is recommended. Test pressure should not exceed 60 PSIG.

a. Roof Mounted Fluid Cooler

To fill the system pour the premixed water and glycol into the expansion tank. Fill the system until the expansion tank is half full, then purge the air from ALL vents. Operate the system for a minute, then purge ALL vents again, and add glycol as required. Repeat the purging of all vents after the first hour of operation and again after several hours of operation.

b. Ground Mounted Fluid Cooler

The fluid cooler may be lowest point in the system, consequently the premixed water and glycol will have to be pumped into the system. Close the shut off valve and open the two hose bibbs installed in the piping run on the leaving side of the pump, see piping diagram.

Connect a pump and hose to the hose bibb away from the pump and a hose to the hose bibb closest to the pump. Begin pumping the glycol mixture into the system at FULL PRESSURE. For the return hose you should close the hose bibb so that you get only a small flow of fluid or air. This is necessary so you will build a head of fluid which will force the air from the system. Once all the air is out you will have a steady flow of only fluid. At this joint you should close off the two hose bibbs and open the shut off valve. See Diagram 3.

3. Flow Adjustment Procedure:

Once the system is completely full of fluid, start the fluid circulating pump. To assure proper fluid flow, adjust the shut-off valve for required GPM by checking pump curve and observing gauge pressure, or by using an in-line flow meter.

4. Instruction Envelope:

Keep wiring diagrams, instructions, list of spare parts, in an envelope within easy reach of the installed dry cooler.

Diagram 3.

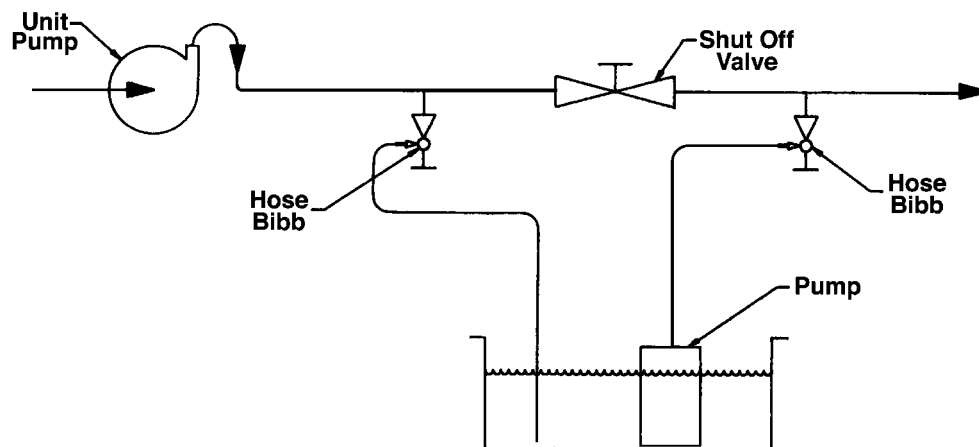

Space and Location Requirements

The most important consideration which must be taken into account when deciding upon the location of air-cooled equipment is the provision for a supply of ambient air to the condenser, and removal of heated air from the fluid cooler area. Where this essential requirement is not adhered to, it will result in higher head pressures, which cause poor operation and possible eventual failure of equipment. Units must not be located in the vicinity of steam, hot air or fume exhausts.

Another consideration which must be taken is that the unit should be mounted away from noise sensitive spaces and must have adequate support to avoid vibration and noise transmission into the building. Units should be mounted over corridors, utility areas, rest rooms and other auxiliary areas where high levels of sound are not an important factor. Sound and structural consultants should be retained for recommendations.

Walls or Obstructions

The unit should be located so that air may circulate freely and not be recirculated. For proper air flow and access all sides of the unit should be a minimum of "W" away from any wall or obstruction. It is preferred that this distance be increased whenever possible. Care should be taken to see that ample

room is left for maintenance work through access doors and panels. Overhead obstructions are not permitted. When the unit is in an area where it is enclosed by three walls the unit must be installed as indicated for units in a pit.

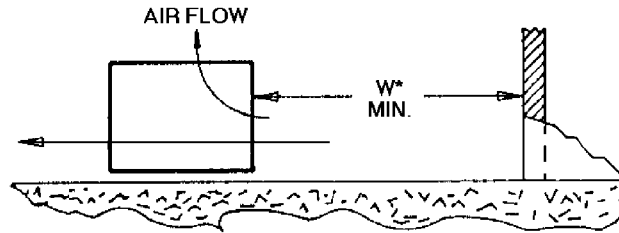

Multiple Units

For units placed side by side, the minimum distance between units is the width of the largest unit. If units are placed end to end, the minimum distance between units is 4 feet.

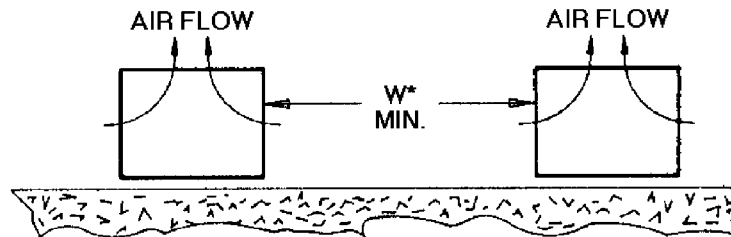

Units in Pits

The top of the unit should be level with the top of the pit, and side distance increased to "2W".

If the top of the unit is not level with the top of pit, discharge cones or stacks must be used to raise discharge air to the top of the pit. This is a minimum requirement.

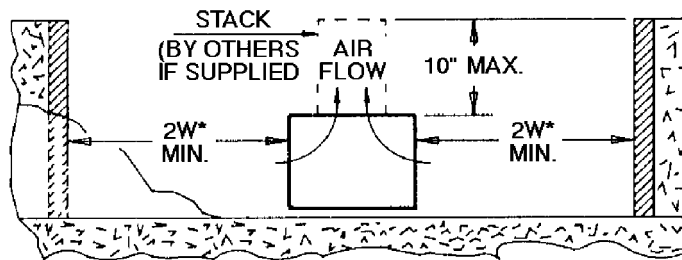

Decorative Fences

Fences must have 50% free area, with 1 foot undercut, a "W" minimum clearance, and must not exceed the top of

unit. If these requirements are not met, unit must be installed as indicated for "Units in pits".

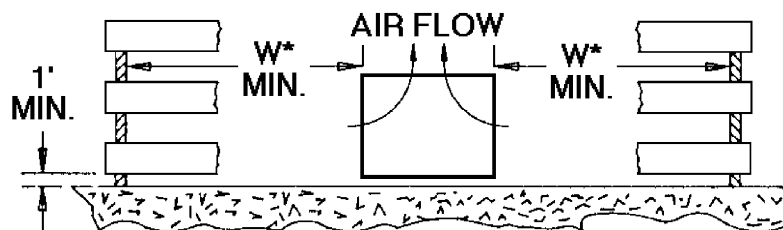

* "W" = Total width of the fluid cooler.

Diagram 4. Typical Piping

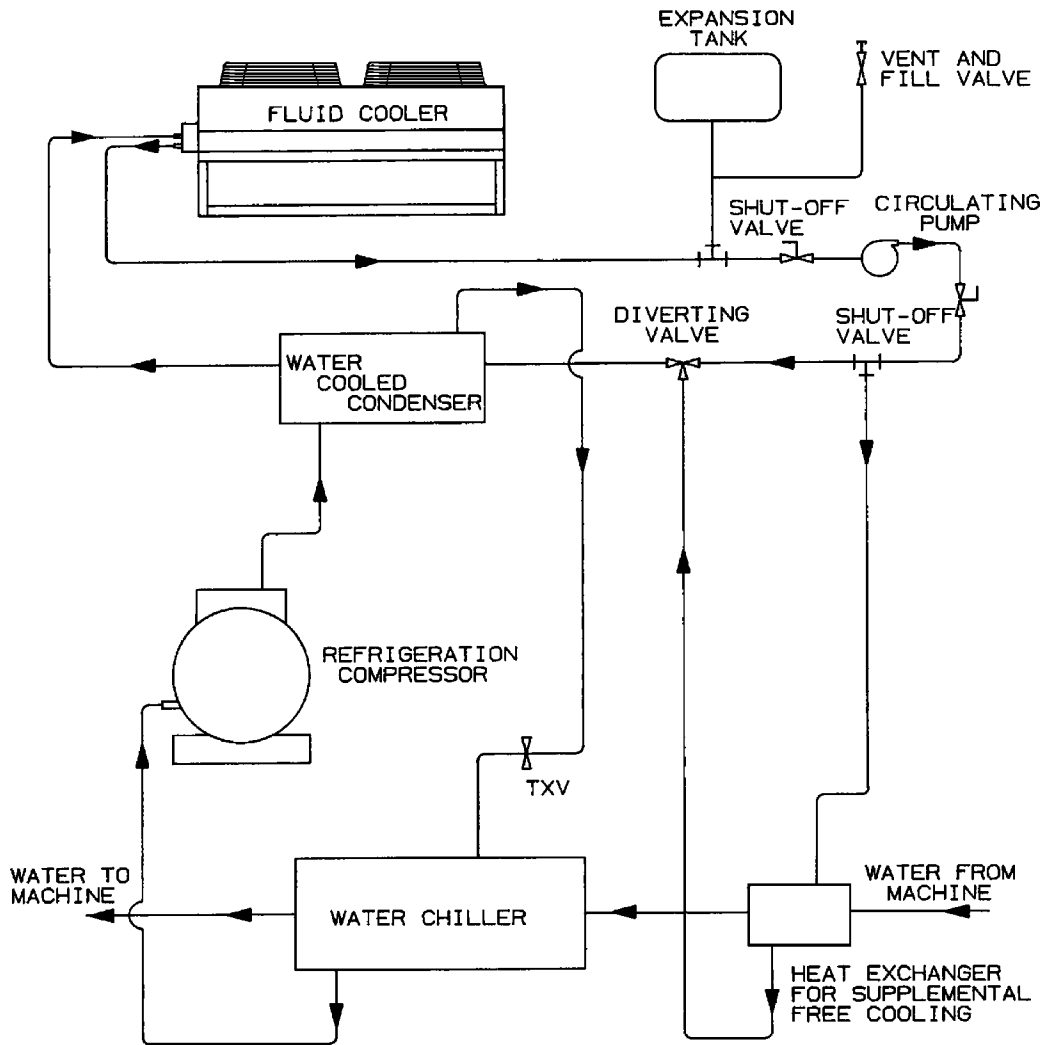

In-Warranty Return Material Procedure

Material may not be returned except by permission of authorized factory service personnel of Heatcraft Inc. Refrigeration Products Division in Stone Mountain, Georgia. A "Return Goods" tag will be sent to be included with the returned material. Enter the required information on the tag in order to expedite handling at our factories and prompt issuance of credits. All parts shall be returned to the factory designated on the "Return Goods" tag, transportation charges prepaid.

The return of a part does not constitute an order for replacement. Therefore, a purchase order must be entered through your nearest Heatcraft Refrigeration Products representative. The order should include part number, model number and serial number of the unit involved.

Following our careful inspection of the returned part and if it is determined that the failure is due to faulty material or workmanship, credit will be issued on customer's purchase order.

Replacement Parts

When writing to the factory for service or replacement parts, refer to the model number and serial number of the unit as stamped on the serial plate attached to the unit. If replacement parts are

required, mention the date of installation of the unit and date of failure, along with an explanation of the malfunctions and a description of the replacement parts required.

Table 5. Replacement Parts List

Part Description	Part Number		
	208-230/3/60	460/3/60	575/3/60
Fan Motor, 1 1/2 HP, 1140 RPM	25301801	25301801	25302001
Fan Blade, 30"	22900401	22900401	22900401
Fan Guard, 30"	23100301	23100301	23100301

Contact Customer Service Department for parts to specific fluid cooler models.

Since product improvement is a continuing effort at Heatcraft, we reserve the right to make changes in specifications without notice.



Heatcraft Refrigeration Products
2175 West Park Place Blvd.
Stone Mountain, GA 30087
(770) 939-4450 • Fax: (770) 908-5480
www.heatcrafttrpd.com

Free Manuals Download Website

<http://myh66.com>

<http://usermanuals.us>

<http://www.somanuals.com>

<http://www.4manuals.cc>

<http://www.manual-lib.com>

<http://www.404manual.com>

<http://www.luxmanual.com>

<http://aubethermostatmanual.com>

Golf course search by state

<http://golfingnear.com>

Email search by domain

<http://emailbydomain.com>

Auto manuals search

<http://auto.somanuals.com>

TV manuals search

<http://tv.somanuals.com>