

FL AC Scroll Refrigeration Systems

H-IM-FL1A

December, 2004

Part No. 25006901

Installation and Operation Manual



Table of Contents

General Safety Information	2
Inspection	2
Warranty Statement.....	2
Air Cooled Condensing Unit and Condenser Space and Location Requirements	3
Condensing Unit Rigging and Mounting.....	4
Ambient Fan Cycle Control	4
Condensing Unit Accessories	5
Suction Filters, Driers, Sight Glasses	5
Refrigerant Oils	6
Phase Loss Monitor.....	7
Recommended Refrigerant Piping Practices	7
Refrigeration Pipe Supports	7
Suction Lines	8
Suction Line Risers	8
Liquid Lines	8
Evacuation and Leak Detection.....	11
Refrigerant Charging Instructions.....	12
Field Wiring.....	12
Check Out and Start Up	12
Operational Check Out.....	13
System Balancing - Compressor Superheat	13
System Troubleshooting Guide	14
Preventive Maintenance Guidelines	15
Replacement Parts	15
Wiring Diagrams	16-18
Submittal	19, 20
Service Record.....	21

General Safety Information

1. Installation and maintenance to be performed only by qualified personnel who are familiar with this type of equipment.
2. Some units are pressurized with dry air or inert gas. All units must be evacuated before charging the system with refrigerant.
3. Make sure that all field wiring conforms to the requirements of the equipment and all applicable national and local codes.
4. Avoid contact with sharp edges and coil surfaces. They are a potential injury hazard.
5. Make sure all power sources are disconnected before any service work is done on units.

WARNING: Refrigerant can be harmful if it is inhaled. Refrigerant must be used and recovered responsibly. **Failure to follow this warning may result in personal injury or death.**

Inspection

Responsibility should be assigned to a dependable individual at the job site to receive material. Each shipment should be carefully checked against the bill of lading. The shipping receipt should not be signed until all items listed on the bill of lading have been accounted. Check carefully for concealed damage. Any shortage or damages should be reported to the delivering carrier. Damaged material becomes the delivering carrier's responsibility, and should not be returned to the manufacturer unless prior approval is given to do so. When uncrating, care should be taken to prevent damage. Heavy equipment should be left on its shipping base until it has been moved to the final location. Check the serial tag information with invoice. Report any discrepancies to your Heatcraft Refrigeration Products Sales Representative.

Warranty Statement

Seller warrants to its direct purchasers that products, including Service Parts, manufactured by SELLER shall be of a merchantable quality, free of defects in material or workmanship, under normal use and service for a period of one **(1) year from date of original installation, or eighteen (18) months from date of shipment** by SELLER, whichever first occurs. Any product covered by this order found to Seller's satisfaction to be defective upon examination at Seller's factory will at SELLER's option, be repaired or replaced and returned to Buyer via lowest common carrier, or SELLER may at its option grant Buyer a credit for the purchase price of the defective article. Upon return of a defective product to SELLER's plant, freight prepaid, by Buyer, correction of such defect by repair or replacement, and return freight via lowest common carrier, shall constitute full performance by SELLER of its obligations hereunder.

SELLER shall have no liability for expenses incurred for repairs made by Buyer except by prior, written authorization. Every claim on account of breach of warranty shall be made to SELLER in writing within the warranty period specified above – otherwise such claim shall be deemed waived. Seller shall have no warranty obligation whatsoever if its products have been subjected to alteration, misuse, negligence, free chemicals in system, corrosive atmosphere, accident, or if operation is contrary to SELLER's or manufacturer's recommendations, or if the serial number has been altered, defaced, or removed.

MOTOR COMPRESSORS:

Motor compressors furnished by SELLER are subject to the standard warranty terms set forth above, except that motor compressor replacements or exchanges shall be made through the nearest authorized wholesaler of the motor compressor manufacturer (not at SELLER's factory) and no freight shall be allowed for transportation of the motor compressor to and from the wholesaler. The replacement motor compressor shall be identical to the model of the motor compressor being replaced. Additional charges which may be incurred throughout the substitution of other than identical replacements are not covered by this warranty.

An optional, nonassignable, four (4) year extended compressor warranty may be purchased within the boundaries of the United States of America, its territories and possessions, and Canada. With this extended compressor warranty, replacements are administered by an authorized compressor distributor only. Replacements within the first year of the warranty area available through the distributor; the second through fifth years, the purchaser must submit a proof-of-purchase of a compressor and supply it to Heatcraft Refrigeration Products Warranty Claims for reimbursement.

Seller makes no express warranties except as noted above. All implied warranties are limited to the duration of the Express Warranty. Liability for incidental and consequential damages is excluded.

The forgoing is in lieu of all other warranties, express or implied, notwithstanding the provisions of the uniform commercial code, the Magnuson-Moss Warranty-Federal Trade Commission Improvement Act, or any other statutory or common law, federal or state.

SELLER makes no warranty, express or implied, of fitness for any particular purpose, or of any nature whatsoever, with respect to products manufactures or sold by seller hereunder, except as specifically set forth above and on the face hereof. It is expressly understood and agreed that SELLER shall not be liable to buyer, or any customer of buyer, for direct or indirect, special, incidental, consequential or penal damages, or for any expenses incurred by reason of the use or misuse by buyer or third parties of said products. To the extent said products may be considered "consumer products," As defined in Sec. 101 of the Magnuson-Moss Warranty - Federal Trade Commission Improvement Act, SELLER makes no warranty of any kind, express or implied, to "consumers," except as specifically set forth above and on the face hereof.

The following conditions should be adhered to when installing this unit to maintain the manufacturers warranty:

- (a) System piping must be in accordance with good refrigeration practices.
- (b) **Inert gas must be charged into the piping during brazing.**
- (c) The power supply to the unit must meet the following conditions:
 - A. Three phase voltages must be +/- 10% of nameplate ratings. Single phase must be within +10% or -5% of nameplate ratings.
 - B. Phase imbalance cannot exceed 2%.
- (d) All control and safety switch circuits must be properly connected according to the wiring diagram.
- (e) The factory installed wiring must not be changed without written factory approval.
- (f) All equipment is installed in accordance with Heatcraft specified minimum clearances.

Space and Location Requirements for Air Cooled Condensing Units and Remote Condensers

The most important consideration which must be taken into account when deciding upon the location of air-cooled equipment is the provision for a supply of ambient air to the condenser, and removal of heated air from the condensing unit or remote condenser area. Where this essential requirement is not adhered to, it will result in higher head pressures, which cause poor operation and potential failure of equipment. Units must not be located in the vicinity of steam, hot air or fume exhausts. Corrosive atmospheres require custom designed condensers.

Another consideration which must be taken is that the unit should be mounted away from noise sensitive spaces and must have adequate support to avoid vibration and noise transmission into the building. Units should be mounted over corridors, utility areas, rest rooms and other auxiliary areas where high levels of sound are not an important factor. Sound and structural consultants should be retained for recommendations.

Figure 1. Space and Location Requirements for Condensing Units and Remote Condensers

Walls or Obstructions

The unit should be located so that air may circulate freely and not be recirculated. For proper air flow and access all sides of the unit should be a minimum of "W" away from any wall or obstruction. It is preferred that this distance be increased whenever possible. Care should be taken to see that ample room is left for maintenance work through access doors and panels. Overhead obstructions are not permitted. When the unit is in an area where it is enclosed by three walls the unit must be installed as indicated for units in a pit.

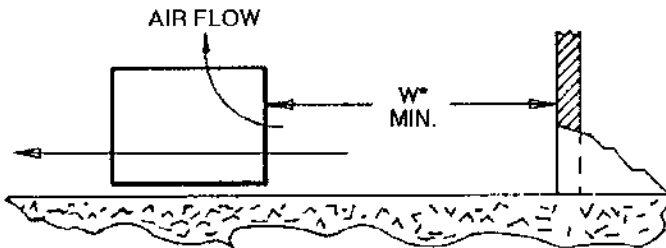

Multiple Units

For units placed side by side, the minimum distance between units is the width of the largest unit. If units are placed end to end, the minimum distance between units is 4 feet.

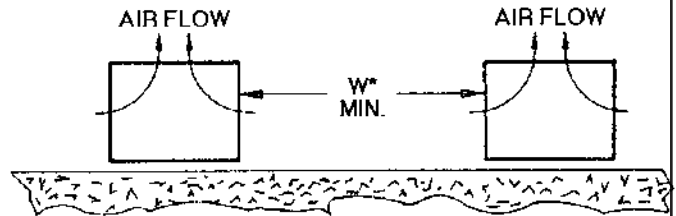

Units in Pits

The top of the unit should be level with the top of the pit, and side distance increased to "2W".

If the top of the unit is not level with the top of pit, discharge cones or stacks must be used to raise discharge air to the top of the pit. This is a minimum requirement.

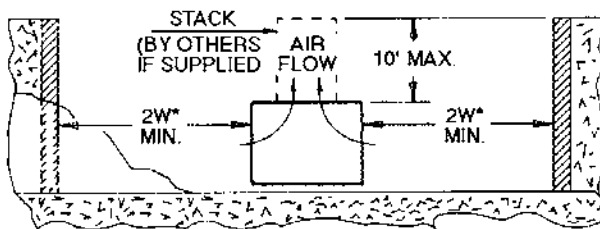

Decorative Fences

Fences must have 50% free area, with 1 foot undercut, a "W" minimum clearance, and must not exceed the top of unit. If these requirements are not met, unit must be installed as indicated for "Units in pits".

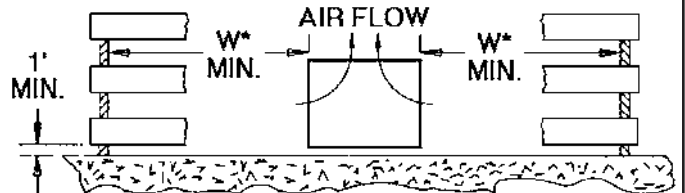

* "W" = Total width of the condensing unit or condenser.

Condensing Unit Rigging and Mounting

Rigging holes are provided on all units. Caution should be exercised when moving these units. To prevent damage to the unit housing during rigging, cables or chains used must be held apart by spacer bars. The mounting platform or base should be level and located so as to permit free access of supply air.

Ground Mounting

Concrete slab raised six inches above ground level provides a suitable base. Raising the base above ground level provides some protection from ground water and wind blown matter. Before tightening mounting bolts, recheck level of unit. The unit should in all cases be located with a clear space in all directions that is at a minimum, equal to the height of the unit above the mounting surface. A condensing unit mounted in a corner formed by two walls, may result in discharge air recirculation with resulting loss of capacity.

Roof Mounting

Due to the weight of the units, a structural analysis by a qualified engineer may be required before mounting. Roof mounted units should be installed level on steel channels or an I-beam frame capable of supporting the weight of the unit. Vibration absorbing pads or springs should be installed between the condensing unit legs or frame and the roof mounting assembly.

Access

Provide adequate space at the compressor end of the unit for servicing. Provide adequate space on the connection side to permit service of components.

Spring Mounted Compressor

Compressors are secured rigidly to make sure there is no transit damage. Before operating the unit, it is necessary to follow these steps:

- a. Remove the upper nuts and washers.
- b. Discard the shipping spacers.
- c. Install the neoprene spacers. (Spacers located in the electrical panel or tied to compressor.)
- d. Replace the upper mounting nuts and washers.
- e. Allow 1/16 inch space between the mounting nut/washer and the neoprene spacer.

Rigid Mounted Compressor

Some products use rigid mounted compressors. Check the compressor mounting bolts to insure they have not vibrated loose during shipment.

Figure 2. Solid Mount for Mobile or Deep Sump Application.

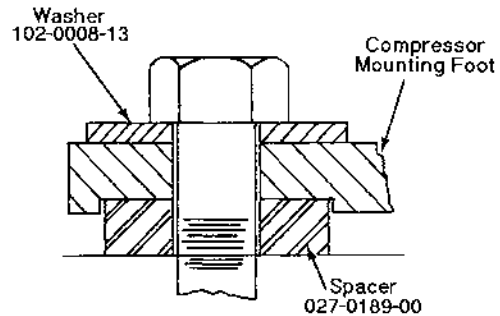

Ambient Fan Cycle Control

This is an automatic winter control method which will maintain a condensing pressure within reasonable limits by cycling fan motors in response to outside air temperature. The thermostat(s) should be field adjusted to shut off the fan when the condensing temperature is reduced to approximately 90°F. Table 2 on page 5 lists approximate settings for several system T.D.'s. These settings are approximate as they do not take into account variations in load.

CAUTION: Under no circumstance should all condenser motors be allowed to cycle off on one control. At least one motor shall be wired to operate at all times. Under most circumstances, the condenser motor nearest the inlet header should remain on whenever the compressor is operating.

Condensing Unit Accessories

Suction Filters, Driers, Sight Glasses

There are two types of suction and liquid filter/driers used on Heatcraft Refrigeration Products units. Replaceable core and/or sealed units are used, dependent upon the option package ordered.

Suction filters, regardless of type, are always installed upstream of the compressor suction service valve, and any accumulators or other options that may be installed. Suction filters are equipped with "Schrader" type access valves to allow field measurement of pressure drop across the device. This allows plugged filters and elements to be identified very quickly and easily so they can be replaced when the pressure drop is excessive. Refer to the specific manufacturers' recommendation on servicing these units by make and model.

Liquid filter/driers, regardless of type, are always installed downstream of the receiver outlet service valve, and up-

stream of the liquid line solenoid valve (if supplied). Liquid line driers may or may not have an access valve, dependent on the size and application. The basic servicing of these units is similar to suction filters. Liquid line driers should be replaced whenever there is evidence of excessive pressure drop across the filter, or the system becomes contaminated due to system leaks, compressor burnouts, acid formation, or moisture accumulation as indicated by the liquid line sight glass.

The sight glass is installed in the main liquid line assembly, downstream from the receiver outlet service valve, and immediately after the liquid line drier. The sight glass is designed to give a visual indication of moisture content in the system. Generally, it requires no field service. However, in cases of extreme acid formation in a system after a compressor burnout, the acid may damage the sensing element or etch the glass. This would require that the sight glass be replaced, along with the liquid line drier after any compressor motor burnout.

Table 1. Recommended Low Pressure Control Settings for Outdoor Air Cooled Condensing Units

*Minimum Temp. °F	R-22		R-404A/R-507		R-134a	
	Cut-In PSI	Cut-Out PSI	Cut-In PSI	Cut-Out PSI	Cut-In PSI	Cut-Out PSI
50	70	20	90	35	45	15
40	55	20	70	35	35	10
30	40	20	55	35	25	10
10	30	10	45	25	13	0
0	15	0	25	7	8	0
-10	15	0	20	1	---	---
-20	10	0	12	1	---	---
-30	6	0	8	1"Hg.	---	---

* Minimum ambient or box temperature anticipated, Hi pressure control setting: R-22, 360 PSI; R-404A, R-507, 400 PSI; R-134a, 225 PSI.

Table 2. Thermostat Settings

Models	Design T.D.	Thermostat Settings		
		T1	T2	T3
2-fan units:	30	60		
	25	65		
	20	70		
4-fan units:	15	75		
	30	60	40	
3-fan units:	25	65	55	
	20	70	60	
6-fan units:	15	75	65	
	30	60	50	30
8-fan units:	25	65	55	40
	20	70	65	50
	15	75	70	60

NOTE: Cycle pairs of fans on double wide units.

<p>CAUTION: Fans closest to the headers should not be cycled on standard temperature or pressure controls. Dramatic temperature and pressure changes at the headers as a result of fan action can result in possible tube failure. Fan motors are designed for continuous duty operation.</p>	<p>Fan cycling controls should be adjusted to maintain a minimum of (5) minutes on and (5) minutes off. Short cycling of fans may result in a premature failure of motor and/or fan blade.</p> <p>Compressors operating below +10°F SST must have air flowing over the compressor at all times when the compressor is running.</p>
--	--

Refrigeration Oils*

With the changes that have taken place in our industry due to the CFC issue, we have reevaluated our lubricants to ensure compatibility with the new HFC refrigerants and HCFC interim blends offered by several chemical producers. As a secondary criteria, it is also desirable that any new lubricant be compatible with the traditional refrigerants such as CFC-12, HCFC-22 or R502. This "backward compatibility" has been achieved with the introduction of the Polyol ester lubricants.

Table 3 below summarizes which oils/lubricants are approved for use in Copeland compressors:

Polyol Ester Lubricants

Hygroscopicity

Ester lubricants (POE) have the characteristic of quickly absorbing moisture from the ambient surroundings. This is shown graphically in Figure 3 where it can be seen that such lubricants absorb moisture faster and in greater quantity than conventional mineral oils. Since moisture levels greater than 100 ppm will result in system corrosion and ultimate failure, it is imperative that compressors, components, containers and the entire system be kept sealed as much as possible. Lubricants will be packaged in specially designed, sealed containers. After opening, all the lubricant in a container should be used at once since it will readily absorb moisture if left exposed to the ambient. Any unused lubricant should be properly disposed of. Similarly, work on systems and compressors must be carried out with the open time as short as possible. Leaving the system or compressor open during breaks or overnight **MUST BE AVOIDED!**

Table 3. Refrigeration Oils

Refrigeration Oils		Traditional Refrigerants HCFC-22	Interims R401A, R401B, R402A (MP-39, MP-66, HP-80)	HFC's HFC-134a, R404A, R507
POE's	Mobil EAL ARCTIC 22 CC	A	A	P
	ICI (Virginia KMP) EMKARATE RL 32CF	A	A	P
Mineral Oils	Suniso 3GS	P	PM	NOT ACCEPTABLE
	Texaco WF32	P	PM	
	Calumet R015 (Witco)	P	PM	
	Sontex 200-LT (White Oil)	(BR & Scroll Only)		
	Witco LP-200	P		
A/B	Zerol 200TD	AM	PM	NOT ACCEPTABLE
	Soltex Type AB-200		PM	

P = Preferred Lubricant Choice A = Acceptable Alternative M = Mixture of Mineral Oil and Alkyl Benzene (AB) with minimum 50% AB.

* (Reprinted with permission from Copeland)

Mineral Oils

The BR and Scroll compressors use Sontex 200, a "white oil". This oil is not suitable for low temperature applications nor is it available through the normal refrigeration wholesalers. For field "top-off" the use of 3GS or equivalent, or Zerol 200TD is permissible, as long as at least 50% of the total oil charge remains Sontex 200.

Suniso 3GS, Texaco WF32 and Calumet R015 (yellow oils) are available through normal refrigeration wholesalers. These oils are compatible if mixed and can be used on both high and low temperature systems.

Polyol Ester Lubricants

The Mobil EAL ARCTIC 22 CC is the preferred Polyol ester due to unique additives included in this lubricant. ICI Emkarate RL 32S is an acceptable Polyol ester lubricant approved for use when Mobil is not available. These POE's **must** be used if HFC refrigerants are used in the system. They are also acceptable for use with any

Color

As received, the POE lubricant will be clear or straw colored. After use, it may acquire a darker color. This does not indicate a problem as the darker color merely reflects the activity of the lubricant's protective additive.

Oil Level

During Copeland's testing of Polyol ester oil, it was found that this lubricant exhibits a greater tendency to introduce oil into the cylinder during flooded start conditions. If allowed to continue, this condition will cause mechanical failure of the compressor.

A crankcase heater is required with condensing units and it must be turned on several hours before start-up.

Oil level must not exceed 1/4 sight glass.

Figure 3.

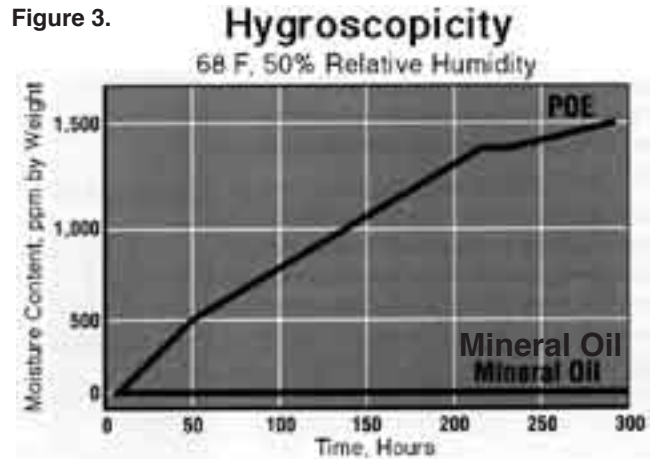

of the traditional refrigerants or interim blends and are compatible with mineral oils. They can therefore be mixed with mineral oils when used in systems with CFC or HCFC refrigerants. These lubricants are compatible with one another and can be mixed.

Alkyl Benzenes

Zerol 200TD is an alkyl benzene (AB) lubricant. Copeland recommends this lubricant for use as a mixture with mineral oil (MO) when using the interim blends such as R-401A, R-401B and R-402A (MP39, MP66 and HP80). A minimum of 50% AB is required in these mixtures to assure proper oil return.

Shell MS 2212 is a 70/30 mixture of AB/MO. If this lubricant is used in a retrofit situation virtually all of the existing MO must be drained prior to refilling with the MS 2212 to assure a minimum 50% AB content.

Phase Loss Monitor

The combination phase sequence and loss monitor relay protects the system against phase loss (single phasing), phase reversal (improper sequence) and low voltage (brownout). When phase sequence is correct and full line voltage is present on all three phases, the relay is energized as the normal condition indicator light glows.

NOTE: If compressor fails to operate and the normal condition indicator light on the phase monitor does not glow, then the supplied electrical current is not in phase with the monitor. This problem is easily corrected by the following steps:

1. **Turn power off at disconnect switch.**
2. Swap any two of the three power input wires.
3. Turn power on. Indicator light should glow and compressor should start.
4. Observe motors for correct rotation.

Recommended Refrigerant Piping Practices

The system as supplied by **Heatcraft Refrigeration Products**, was thoroughly cleaned and dehydrated at the factory. Foreign matter may enter the system by way of the evaporator to condensing unit piping. Therefore, care must be used during installation of the piping to prevent entrance of foreign matter.

Install all refrigeration system components in accordance with applicable local and national codes and in conformance with good practice required for the proper operation of the system.

The interconnecting pipe size is not necessarily the same size as the stub-out on the condensing unit or the evaporator.

The following procedures should be followed:

- (a) Do not leave dehydrated compressors or filter-driers on condensing units open to the atmosphere any longer than is absolutely necessary.
- (b) Use only refrigeration grade copper tubing, properly sealed against contamination.
- (c) Suction lines should slope 1/4" per 10 feet towards the compressor.
- (d) Suitable P-type oil traps should be located at the base of each suction riser of four (4) feet or more to enhance oil return to the compressor.
- (e) For desired method of superheat measurement, a pressure tap should be installed in each evaporator suction line in the proximity of the expansion valve bulb.
- (f) **When brazing refrigerant lines, an inert gas should be passed through the line at low pressure to prevent scaling and oxidation inside the tubing. Dry nitrogen is preferred.**
- (g) Use only a suitable silver solder alloy on suction and liquid lines.
- (h) Limit the soldering paste or flux to the minimum required to prevent contamination of the solder joint internally. Flux only the male portion of the connection, never the female. After brazing, remove excess flux.
- (i) If isolation valves are installed at the evaporator, full port ball valves should be used.

Refrigerant Pipe Support

1. Normally, any straight run of tubing must be supported in at least two locations near each end of the run. Long runs require additional supports. The refrigerant lines should be supported and fastened properly. As a guide, 3/8 to 7/8 should be supported every 5 feet; 1-1/8 and 1-3/8 every 7 feet; and 1-5/8 and 2-1/8 every 9 to 10 feet.
2. When changing directions in a run of tubing, no corner should be left unsupported. Supports should be placed a maximum of 2 feet in each direction from the corner.
3. Piping attached to a vibrating object (such as a compressor or compressor base) must be supported in such a manner that will not restrict the movement of the vibrating object. Rigid mounting will fatigue the copper tubing.
4. Do not use short radius ells. Short radius elbows have points of excessive stress concentration and are subject to breakage at these points.
5. Thoroughly inspect all piping after the equipment is in operation and add supports wherever line vibration is significantly greater than most of the other piping. Extra supports are relatively inexpensive as compared to refrigerant loss.

Figure 4. Example of Pipe Support

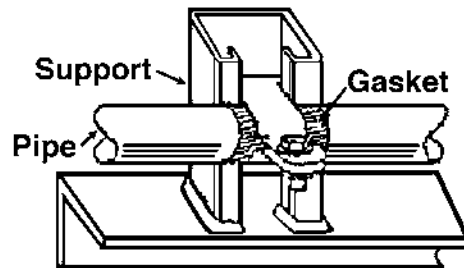
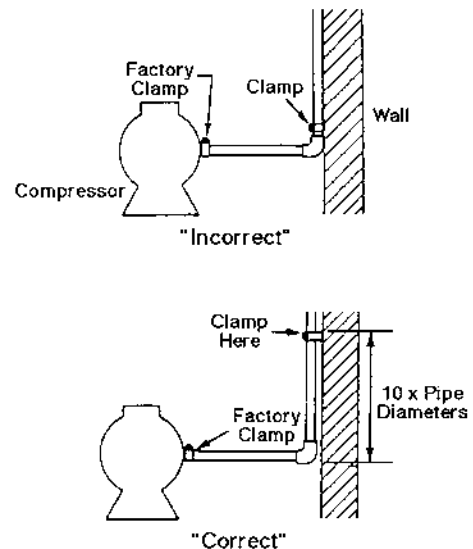

Figure 5. Condensing Unit / Compressor to Wall Support.



Suction Lines

NOTE: If the suction line must rise to a point higher than the suction connection on the evaporator, a suction line trap at the outlet of the evaporator must be provided.

Horizontal suction lines should slope away from the evaporator toward the compressor at the rate of 1/4 inch per 10 feet for good oil return. When multiple evaporators are connected in series using a common suction line, the branch suction lines must enter the top of the common suction line.

For dual or multiple evaporator systems, the branch lines to each evaporator should be sized for the evaporator capacity. The main common line should be sized for the total system capacity.

Suction lines that are outside of refrigerated space must be insulated. See the **Line Insulation** section on page 11 for more information.

Suction Line Risers

Prefabricated wrought copper traps are available, or a trap can be made by using two street ells and one regular ell. The suction trap must be the same size as the suction line. For long vertical risers, additional traps may be necessary. Generally, one trap is recommended for each length of pipe (approximately 20 feet) to insure proper oil movement. See Figure 6 below for methods of constructing proper suction line P-traps.

Figure 6. Suction P-Traps.

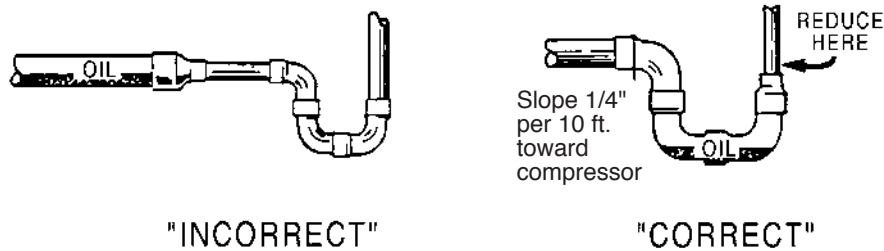

Liquid Lines

Liquid lines should be sized for a minimum pressure drop to prevent "flashing". Flashing in the liquid lines would create additional pressure drop and poor expansion valve operation. If a system requires long liquid lines from the receiver to the evaporator or if the liquid has to rise vertically upward any distance, the losses should be calculated to determine whether or not a heat exchanger is required. The use of a suction to liquid heat exchanger may be used to subcool the liquid to prevent flashing. This method of subcooling will normally provide no more than 20°F subcooling on high pressure

systems. The amount of subcooling will depend on the design and size of the heat exchanger and on the operating suction and discharge pressures. An additional benefit from the use of the suction to liquid type heat exchanger is that it can help raise the superheat in the suction line to prevent liquid return to the compressor via the suction line. Generally, heat exchangers are not recommended on R-22 low temperature systems. However, they have proved necessary on short, well insulated suction line runs to provide superheat at the compressor.

**Table 4. Pressure Loss of Liquid Refrigerants in Liquid Line Risers
(Expressed in Pressure Drop, PSIG, and Subcooling Loss, °F).**

Refrigerant	Liquid Line Rise in Feet																	
	10'		15'		20'		25'		30'		40'		50'		75'		100'	
	PSIG	°F	PSIG	°F	PSIG	°F	PSIG	°F	PSIG	°F	PSIG	°F	PSIG	°F	PSIG	°F	PSIG	°F
R22	4.8	1.6	7.3	2.3	9.7	3.1	12.1	3.8	14.5	4.7	19.4	6.2	24.2	8.0	36.3	12.1	48.4	16.5
R134a	4.9	2.0	7.4	2.9	9.8	4.1	12.3	5.2	14.7	6.3	19.7	8.8	24.6	11.0	36.8	17.0	49.1	23.7
R507, R404A	4.1	1.1	6.1	1.6	8.2	2.1	10.2	2.7	12.2	3.3	16.3	4.1	20.4	5.6	30.6	8.3	40.8	11.8

Based on 110°F liquid temperature at bottom of riser.

Table 5. Equivalent Feet of Pipe Due to Valve and Fitting Friction

	1/2	5/8	7/8	1 1/8	1 3/8	1 5/8	2 1/8	2 5/8	3 1/8	3 5/8	4 1/8	5 1/8	6 1/8
Copper Tuber, O.D., Type "L"													
Globe Valve (Open)	14	16	22	28	36	42	57	69	83	99	118	138	168
Angle Valve (Open)	7	9	12	15	18	21	28	34	42	49	57	70	83
90° Turn Through Tee	3	4	5	6	8	9	12	14	17	20	22	28	34
Tee (Straight Through) or Sweep Below	.75	1	1.5	2	2.5	3	3.5	4	5	6	7	9	11
90° Elbow or Reducing Tee (Straight Through)	1	2	2	3	4	4	5	7	8	10	12	14	16

**Table 6. Weight of Refrigerants in Copper Lines During Operation
(Pounds per 100 lineal feet of type "L" tubing).**

Line Size O.D. in Inches	Refrigerant	Liquid Line	Hot Gas Line	Suction Line at Suction Temperature				
				-40°F	-20°F	0°F	+20°F	+40°F
3/8	134a	4.0	.15	.01	.01	.02	.04	.06
	22	3.9	.22	.02	.03	.04	.06	.08
	R507, 404A	3.4	.31	.03	.04	.06	.09	.13
1/2	134a	7.4	.30	.01	.03	.04	.07	.11
	22	7.4	.41	.03	.05	.07	.11	.15
	R507, 404A	6.4	.58	.04	.07	.13	.16	.24
5/8	134a	11.9	.47	.02	.05	.07	.12	.17
	22	11.8	.65	.05	.08	.12	.17	.25
	R507, 404A	10.3	.93	.07	.11	.17	.25	.35
7/8	134a	24.7	.99	.05	.10	.15	.24	.36
	22	24.4	1.35	.10	.16	.24	.36	.51
	R507, 404A	21.2	1.92	.15	.23	.37	.51	.72
1 1/8	134a	42.2	1.70	.08	.17	.26	.41	.60
	22	41.6	2.30	.17	.28	.42	.61	.87
	R507, 404A	36.1	3.27	.26	.39	.63	.86	1.24
1 3/8	134a	64.2	2.57	.14	.26	.40	.61	1.91
	22	63.5	3.50	.27	.42	.64	.93	1.33
	R507, 404A	55.0	4.98	.40	.58	.95	1.32	1.87
1 5/8	134a	90.9	3.65	.20	.37	.57	.87	1.30
	22	90.0	4.96	.37	.59	.90	1.33	1.88
	R507, 404A	78.0	7.07	.56	.82	1.35	1.86	2.64
2 1/8	134a	158	6.34	.34	.64	.98	1.51	2.24
	22	156	8.61	.65	1.03	1.57	2.30	3.26
	R507, 404A	134	12.25	.98	1.43	2.35	3.23	4.58
2 5/8	134a	244	9.78	.52	.99	1.51	2.32	3.47
	22	241	13.70	1.01	1.59	2.42	3.54	5.03
	R507, 404A	209	18.92	1.51	2.21	3.62	5.00	7.07
3 1/8	134a	348	13.97	.75	1.41	2.16	3.31	4.96
	22	344	18.95	1.44	2.28	3.45	5.05	7.18
	R507, 404A	298	27.05	2.16	3.15	5.17	7.14	9.95
3 5/8	134a	471	18.90	.99	1.91	2.92	4.48	6.69
	22	465	25.60	1.94	3.08	4.67	6.83	9.74
	R507, 404A	403	36.50	2.92	4.25	6.97	19.65	13.67
4 1/8	134a	612	24.56	1.29	2.49	3.81	5.84	8.75
	22	605	33.40	2.53	4.01	6.08	8.90	12.70
	R507, 404A	526	47.57	3.80	5.55	9.09	12.58	17.80

Evacuation and Leak Detection

Due to the smaller molecule size of HFC's, they will tend to leak more readily than CFC's. Consequently, it is of the utmost importance that proper system evacuation and leak detection procedures be employed.

Copeland recommends a minimum evacuation to 500 microns. In addition, a vacuum decay test is strongly recommended to assure there is not a large pressure differential between the system and vacuum pump. Good evacuation processes include frequent vacuum pump oil changes and large diameter, short hose connections to both high and low sides of the system preferably using bronze braided hose.

Leak detection can be carried out in the conventional manner. If HCFC or CFC tracer gas is used, care must be taken to completely remove all traces of the gas prior to introducing HFC's.

Electronic leak detectors are now available that will sense HFC's. This is considered preferable since it removes the possibility of chlorine remaining in the system after leak testing with HCFC's and/or CFC's. There is a view that even small quantities of chlorine may act as a catalyst encouraging copper plating and/or corrosion and should therefore be avoided.

WARNING: HFC-134a has been shown to be combustible at pressure as low as 5.5 psig (at 350°F) when mixed with air at concentrations more than 60% air by volume. At lower temperature, higher pressures are required to support combustion. Therefore, air should never be mixed with HFC-134a for leak detection.

Within the last several years, manufacturers have developed fluorescent dye leak detection systems for use with refrigerants. These dyes mix with the lubricant and, when exposed to an ultraviolet light "fluoresce," indicates the location of leaks. Copeland has tested and approved the Rigid "System Safe" dye and found it to be compatible with the compressor materials in systems.

Leak Testing

After all lines are connected, the entire system must be leak tested. The complete system should be pressurized to not more than 150 psig with refrigerant and dry nitrogen (or dry CO₂). The use of an electronic type leak detector is highly recommended because of its greater sensitivity to small leaks. As a further check it is recommended that this pressure be held for a minimum of 12 hours and then rechecked. For a satisfactory installation, the system must be leak tight.

Line Insulation

After the final leak test, refrigerant lines exposed to high ambient conditions should be insulated to reduce heat pickup and prevent the formation of flash gas in the liquid lines. Suction lines should be insulated with 3/4" wall Armstrong "Armaflex" or equal. Liquid lines should be insulated with 1/2 inch wall insulation or better. The insulation located in outdoor environments should be protected from UV exposure to prevent deterioration of insulating value.

Evacuation

CAUTION: Do not use the refrigeration compressor to evacuate the system. Do not start the compressor while it is in a vacuum.

A good, deep vacuum pump should be connected to both the low and high side evacuation valves with copper tube or high vacuum hoses (1/4" ID minimum). If the compressor has service valves, they should remain closed. A deep vacuum gauge capable of registering pressure in microns should be attached to the system for pressure readings.

A shut off valve between the gauge connection and vacuum pump should be provided to allow the system pressure to be checked after evacuation. Do not turn off vacuum pump when connected to an evacuated system before closing shut off valve.

The vacuum pump should be operated until a pressure of 1,500 microns absolute pressure is reached — at which time the vacuum should be broken with the refrigerant to be used in the system through a drier until the system pressure rises above "0" psig.

NOTE: Refrigerant used during evacuation cannot be vented. Reclaim all used refrigerant. EPA regulations are constantly being updated to ensure your procedure follows correct regulations.

Repeat this operation a second time.

Open the compressor service valves and evacuate the entire system to 500 microns absolute pressure. Raise the pressure to 2 psig with the refrigerant and remove the vacuum pump.

Refrigerant Charging Instructions

1. Install a liquid line drier in the refrigerant supply line between the service gauge and the liquid service port of the receiver. This extra drier will insure that all refrigerant supplied to the system is clean and dry.
2. When initially charging a system that is in a vacuum, liquid refrigerant can be added directly into the receiver tank.
3. Check serial data tag attached to the unit for refrigerant capacity. System refrigerant capacity is 90% of receiver capacity. Do not add more refrigerant than the data tag indicates. Weigh the refrigerant drum before charging so an accurate record can be kept of the weight of refrigerant put in the system.
4. Start the system and finish charging until the sight glass indicates a full charge and the proper amount has been weighed in. If the refrigerant must be added to the system through the suction side of the compressor, charge in vapor form only. Liquid charging must be done in the high side only or with liquid metering devices to protect the compressor.

Field Wiring

WARNING: All wiring must be done in accordance with applicable codes and local ordinances.

The field wiring should enter the areas as provided on the unit. The wiring diagram for each unit is located on the inside of the electrical panel door. All field wiring should be done in a professional manner and in accordance with all governing codes. Before operating unit, double check all wiring connections, including the factory terminals. Factory connections can vibrate loose during shipment.

1. The nameplate on the unit is marked with the electrical characteristic for wiring the unit.
2. Consult the wiring diagram in the unit cooler and in the condensing unit for proper connections.
3. For air cooled condensers, due to multiple low amp motors, we recommend using time delay fuse protection instead of circuit breakers.

Check Out and Start Up

After the installation has been completed, the following points should be covered before the system is placed in operation:

- (a) Check all electrical and refrigerant connections. Be sure they are all tight.
- (b) Check high and low pressure controls, pressure regulating valves, oil pressure safety controls, and all other safety controls, and adjust if necessary.
- (c) Check the room thermostat for normal operation and adjust.
- (d) Wiring diagrams, instruction bulletins, etc. attached to the condensing units should be read and filed for future reference.
- (e) All fan motors on air cooled condensers, evaporators, etc. should be checked for proper rotation. Fan motor mounts should be carefully checked for tightness and proper alignment.
- (f) Electric and hot gas evaporator fan motors should be temporarily wired for continuous operation until the room temperature has stabilized.
- (g) Observe system pressures during charging and initial operation. Do not add oil while the system is short of refrigerant unless oil level is dangerously low.
- (h) Continue charging until system has sufficient refrigerant for proper operation. Do not overcharge. Remember that bubbles in a sight glass may be caused by a restriction as well as a shortage of refrigerant.
- (i) Do not leave unit unattended until the system has reached normal operating conditions and the oil charge has been properly adjusted to maintain the oil level at the center of the sight glass.

CAUTION: Extreme care must be taken in starting compressors for the first time after system charging. At this time, all of the oil and most of the refrigerant might be in the compressor creating a condition which could cause compressor damage due to slugging. Activating the crankcase heater for 24 hours prior to start-up is required. If no crankcase heater is present, then directing a 500 watt heat lamp or other safe heat source on the lower shell of the compressor for approximately thirty minutes will be beneficial in eliminating this condition which might never reoccur.

WARNING: Scroll compressor is directional dependent. If noisy, change phase of input wiring.

Operational Check Out

After the system has been charged and has operated for at least two hours at normal operating conditions without any indication of malfunction, it should be allowed to operate overnight on automatic controls. Then a thorough recheck of the entire system operation should be made as follows:

- (a) Check compressor discharge and suction pressures. If not within system design limits, determine why and take corrective action.
- (b) Check liquid line sight glass and expansion valve operation. If there are indications that more refrigerant is required, leak test all connections and system components and repair any leaks before adding refrigerant.
- (c) Thermostatic expansion valves must be checked for proper superheat settings. Feeler bulbs must be in positive contact with the suction line and should be insulated. Valves set at high superheat will lower refrigeration capacity. Low superheat promotes liquid slugging and compressor bearing washout.
- (d) Using suitable instruments, carefully check line voltage and amperage at the compressor terminals. Voltage must be within 10% of that indicated on the condensing unit nameplate. If high or low voltage is indicated, notify the power company. If amperage draw is excessive, immediately determine the cause and take corrective action. On three phase motor compressors, check to see that a balanced load is drawn by each phase.
- (e) The maximum approved settings for high pressure controls on Heatcraft air cooled condensing equipment is 400 psig. On air cooled systems, check as follows: Disconnect the fan motors or block the condenser inlet air. Watch high pressure gauge for cutout point. Recheck all safety and operating controls for proper operation and adjust if necessary.
- (f) Check winter head pressure controls for pressure setting.
- (g) Check crankcase heater operation if used.
- (h) Install instruction card and control system diagram for use of building manager or owner.

NOTE: All adjustable controls and valves must be field adjusted to meet desired operation. There are no factory preset controls or valve adjustments.

System Balancing - Compressor Superheat

IMPORTANT: In order to obtain the maximum capacity from a system, and to ensure trouble-free operation, it is necessary to balance each and every system.

This is extremely important with any refrigeration system.

The critical value which must be checked is suction superheat.

Suction superheat should be checked **at the compressor** as follows:

1. Measure the suction pressure at the suction service valve of the compressor and determine the saturation temperature corresponding to this pressure from a "Temperature-Pressure" chart.
2. Measure the suction temperature of the suction line about one foot back from the compressor using an accurate thermometer.
3. Subtract the saturated temperature from the actual suction line temperature. The difference is superheat.

Too low a suction superheat can result in liquid being returned to the compressor. This will cause dilution of the oil and eventual failure of the bearings and rings or in the extreme case, valve failure.

Too high a suction superheat will result in excessive discharge temperatures which cause a break down of the oil and results in piston ring wear, piston and cylinder wall damage.

It should also be remembered that the system capacity decreases as the suction superheat increases. For maximum system capacity, suction superheat should be kept as low as is practical. Copeland mandates a **minimum** superheat of 20°F **at the compressor**. Heatcraft Refrigeration Products recommends that the superheat **at the compressor** be between 30°F and 45°F.

If adjustments to the suction superheat need to be made, the expansion valve at the evaporator should be adjusted.

Table 7. System Troubleshooting Chart

PROBLEM	POSSIBLE CAUSES	POSSIBLE CORRECTIVE STEPS
Compressor will not run	<ol style="list-style-type: none"> 1. Main switch open. 2. Fuse blown. 3. Thermal overloads tripped. 4. Defective contactor or coil. 5. System shut down by safety devices. 6. No cooling required. 7. Liquid line solenoid will not open. 8. Motor electrical trouble. 9. Loose wiring. 10. Phase loss monitor inoperative. 	<ol style="list-style-type: none"> 1. Close switch. 2. Check electrical circuits and motor winding for shorts or grounds. Investigate for possible overloading. Replace fuse after fault is corrected. 3. Overloads are automatically reset. Check unit closely when unit comes back on line. 4. Repair or replace. 5. Determine type and cause of shutdown and correct it before resetting safety switch. 6. None. Wait until calls for cooling. 7. Repair or replace coil. 8. Check motor for open windings, short circuit or burn out. 9. Check all wire junctions. Tighten all terminal screws. 10. Refer to page 18.
Compressor noisy or vibrating	<ol style="list-style-type: none"> 1. Flooding of refrigerant into crankcase. 2. Improper piping support on suction or liquid line. 3. Worn compressor. 4. Scroll compressor rotation reversed. 	<ol style="list-style-type: none"> 1. Check setting of expansion valves. 2. Relocate, add or remove hangers. 3. Replace. 4. Rewire for phase change.
High discharge pressure	<ol style="list-style-type: none"> 1. Non-condensables in system. 2. System overcharges with refrigerant. 3. Discharge shutoff valve partially closed. 4. Fan not running. 5. Head pressure control setting. 6. Dirty condenser coil. 	<ol style="list-style-type: none"> 1. Remove the non-condensables. 2. Remove excess. 3. Open valve. 4. Check electrical circuit. 5. Adjust. 6. Clean.
Low discharge pressure	<ol style="list-style-type: none"> 1. Faulty condenser temperature regulation. 2. Suction shutoff valve partially closed. 3. Insufficient refrigerant in system. 4. Low suction pressure. 5. Variable head pressure valve. 	<ol style="list-style-type: none"> 1. Check condenser control operation. 2. Open valve. 3. Check for leaks. Repair and add charge. 4. See corrective steps for low suction pressure. 5. Check valve setting.
High suction pressure	<ol style="list-style-type: none"> 1. Excessive load. 2. Expansion valve overfeeding. 	<ol style="list-style-type: none"> 1. Reduce load or add additional equipment. 2. Check remote bulb. Regulate superheat.
Low suction pressure	<ol style="list-style-type: none"> 1. Lack of refrigerant. 2. Evaporator dirty or iced. 3. Clogged liquid line filter drier. 4. Clogged suction line or compressor suction gas strainers. 5. Expansion valve malfunctioning. 6. Condensing temperature too low. 7. Improper TXV. 	<ol style="list-style-type: none"> 1. Check for leaks. Repair and add charge. 2. Clean. 3. Replace cartridge (s). 4. Clean strainers. 5. Check and reset for proper superheat. 6. Check means for regulating condensing temperature. 7. Check for proper sizing.
Little or no oil pressure	<ol style="list-style-type: none"> 1. Clogged suction oil strainer. 2. Excessive liquid in crankcase. 3. Low oil pressure safety switch defective. 4. Worn oil pump. 5. Oil pump reversing gear stuck in wrong position. 6. Worn bearings. 7. Low oil level. 8. Loose fitting on oil lines. 9. Pump housing gasket leaks. 	<ol style="list-style-type: none"> 1. Clean. 2. Check crankcase heater. Reset expansion valve for higher superheat. Check liquid line solenoid valve operation. 3. Replace. 4. Replace. 5. Reverse direction of compressor rotation. 6. Replace compressor. 7. Add oil and/or through defrost. 8. Check and tighten system. 9. Replace gasket.
Compressor loses oil	<ol style="list-style-type: none"> 1. Lack of refrigerant. 2. Excessive compression ring blowby. 3. Refrigerant flood back. 4. Improper piping or traps. 	<ol style="list-style-type: none"> 1. Check for leaks and repair. Add refrigerant. 2. Replace compressor. 3. Maintain proper superheat at compressor. 4. Correct piping.
Compressor thermal protector switch open.	<ol style="list-style-type: none"> 1. Operating beyond design conditions. 2. Discharge valve partially shut. 3. Blown valve plate gasket. 4. Dirty condenser coil. 5. Overcharged system. 	<ol style="list-style-type: none"> 1. Add facilities so that conditions are within allowable limits. 2. Open valve. 3. Replace gasket. 4. Clean coil. 5. Reduce charge.

Preventive Maintenance

Air Cooled Condensing Units

Quarterly

1) Visually inspect unit

- Look for signs of oil stains on interconnection piping and condenser coil. Pay close attention to areas around solder joints, building penetrations and pipe clamps. Check any suspect areas with an electronic leak detector. Repair any leaks found and add refrigerant as needed.
- Check condition of moisture indicator/sightglass in the sight glass if so equipped. Replace liquid line drier if there is indication of slight presence of moisture. Replace refrigerant, oil and drier if moisture concentration is indicated to be high.
- Check moisture indicator/sightglass for flash gas. If found check entire system for refrigerant leaks and add refrigerant as needed after repairing any leaks.
- Check compressor sightglass (if equipped) for proper oil level.
- Check condition of condenser. Look for accumulation of dirt and debris (clean as required).
- Check for unusual noise or vibration. Take corrective action as required.
- Inspect wiring for signs of wear or discoloration and repair if needed.
- Check and tighten all flare connections.

Semi-Annually

2) Repeat all quarterly inspection items.

3) Clean condenser coil and blades

- Periodic cleaning can be accomplished by using a brush, pressurized water and a commercially available foam coil cleaner. If foam cleaner is used, it should not be an acid based cleaner. Follow label directions for appropriate use.
- Rinse until no residue remains.

4) Check operation of condenser fans

- Check that each fan rotates freely and quietly. Replace any fan motor that does not rotate smoothly or makes excessive noise.
- Check all fan blade set screws and tighten as required.
- Check all fan blades for signs of cracks, wear or stress. Pay close attention to the hub and spider. Replace blades as required.
- Verify that all motors are mounted securely.
- Lubricate motors if applicable. Do not lubricate permanently sealed, ball bearing motors.

5) Inspect electrical wiring and components

- Verify that all electrical and ground connections are secure, tighten as required.
- Check condition of compressor and heater contactors. Look for discoloration and pitting. Replace as required.
- Check operation and calibration of all timers, relays pressure controls and safety controls.

- Clean electrical cabinet. Look for signs of moisture, dirt, debris, insects and wildlife. Take corrective action as required.

- Verify operation of crankcase heater by measuring amp draw.

6) Check refrigeration cycle

- Check suction, discharge and net oil pressure readings. If abnormal take appropriate action.
- Check operation of demand cooling, liquid injection or unloaders if so equipped.
- Check pressure drop across all filters and driers. Replace as required.
- Verify that superheat at the compressor conforms to specification. (30°F to 45°F)
- Check pressure and safety control settings and verify proper operation.

Annually

7) In addition to quarterly and semiannual maintenance checks, submit an oil sample for analysis

- Look for high concentrations of acid or moisture. Change oil and driers until test results read normal.
- Investigate source of high metal concentrations, which normally are due to abnormal bearing wear. Look for liquid refrigerant in the crankcase, low oil pressure or low superheat as a possible source.

Replacement Parts

Whenever possible, replacement parts are to be obtained from a local wholesaler authorized to sell one of Heatcraft Refrigeration Products' brands. Replacement parts which are covered under the terms of the warranty statement on page 2 of this manual, will be reimbursed for total part cost only. The original invoice from the parts supplier must accompany all warranty claims for replacement part reimbursement. Heatcraft Refrigeration Products reserves the right to adjust the compensation amount paid on any parts submitted for warranty reimbursement when a parts supplier's original invoice is not provided with a claim. You may obtain information regarding local authorized wholesalers by calling the Heatcraft Refrigeration Products Replacement Parts Center at 1-800-686-7278 between the hours of 7:30 AM to 4:30 PM Central Time.

Wiring Diagram for BACU51D2CHPQ

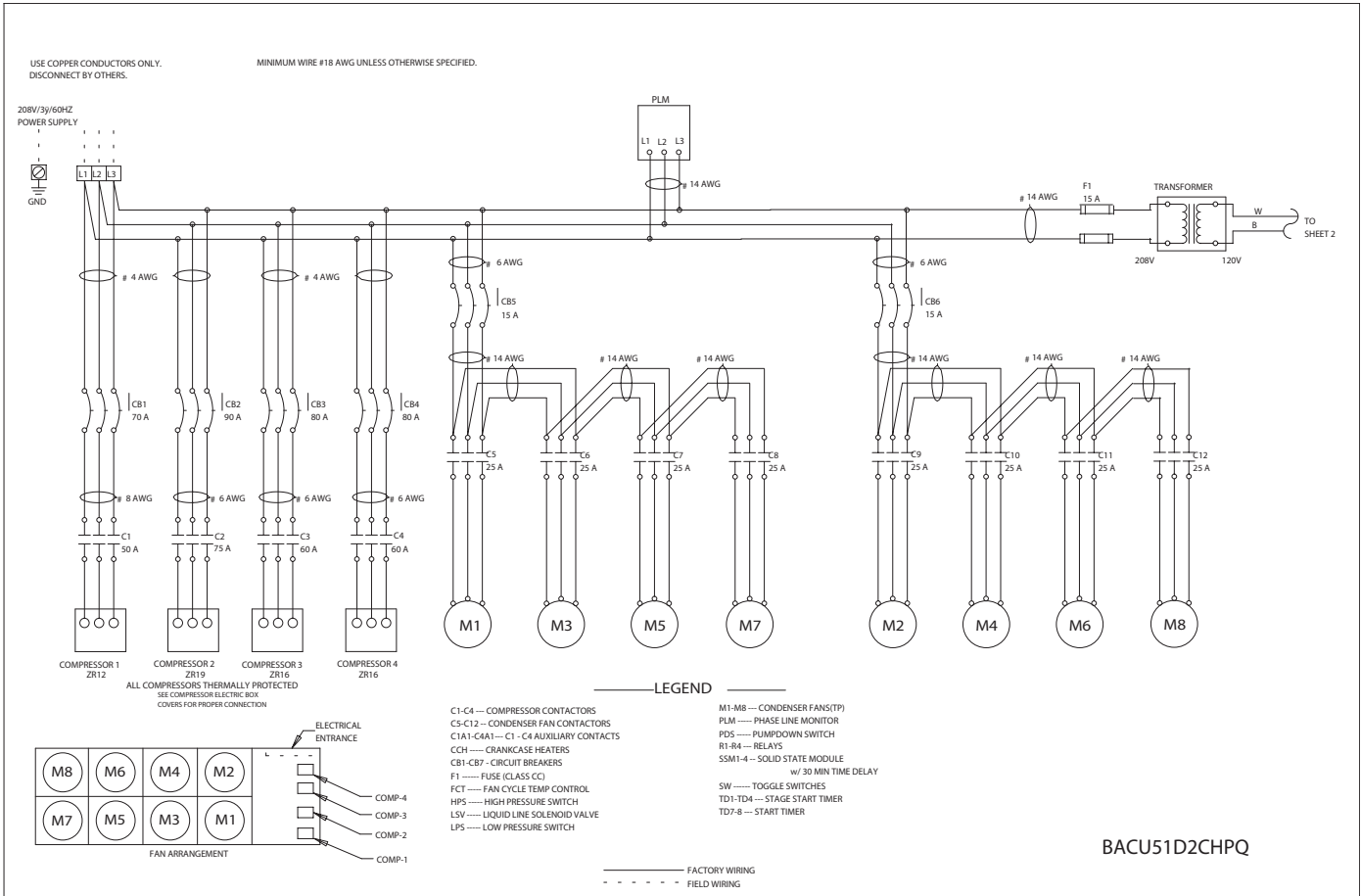

Wiring Diagram for BACU59D2CHPQ

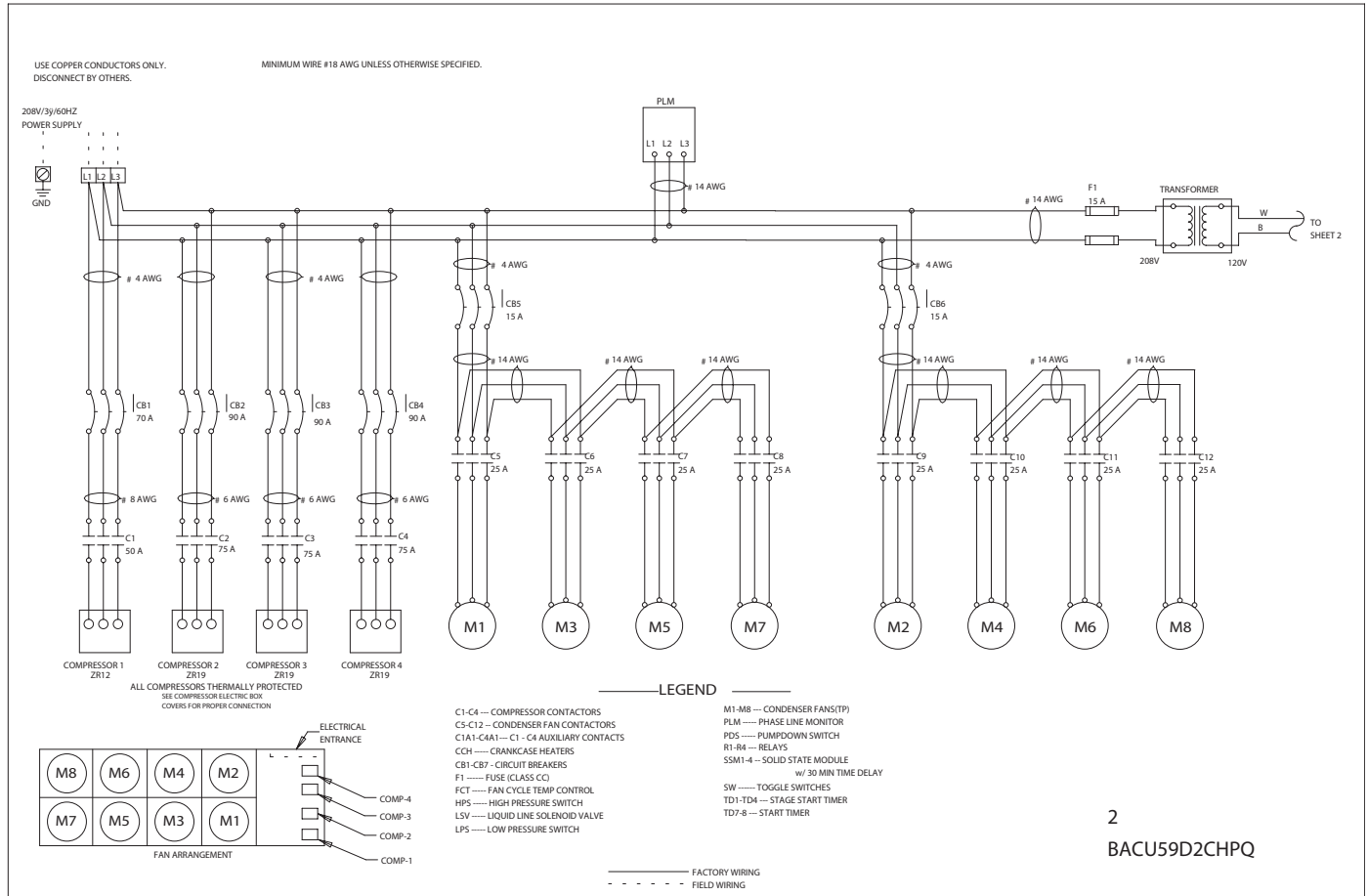

Control Circuit Wiring Diagram for BACU51 and BACU59

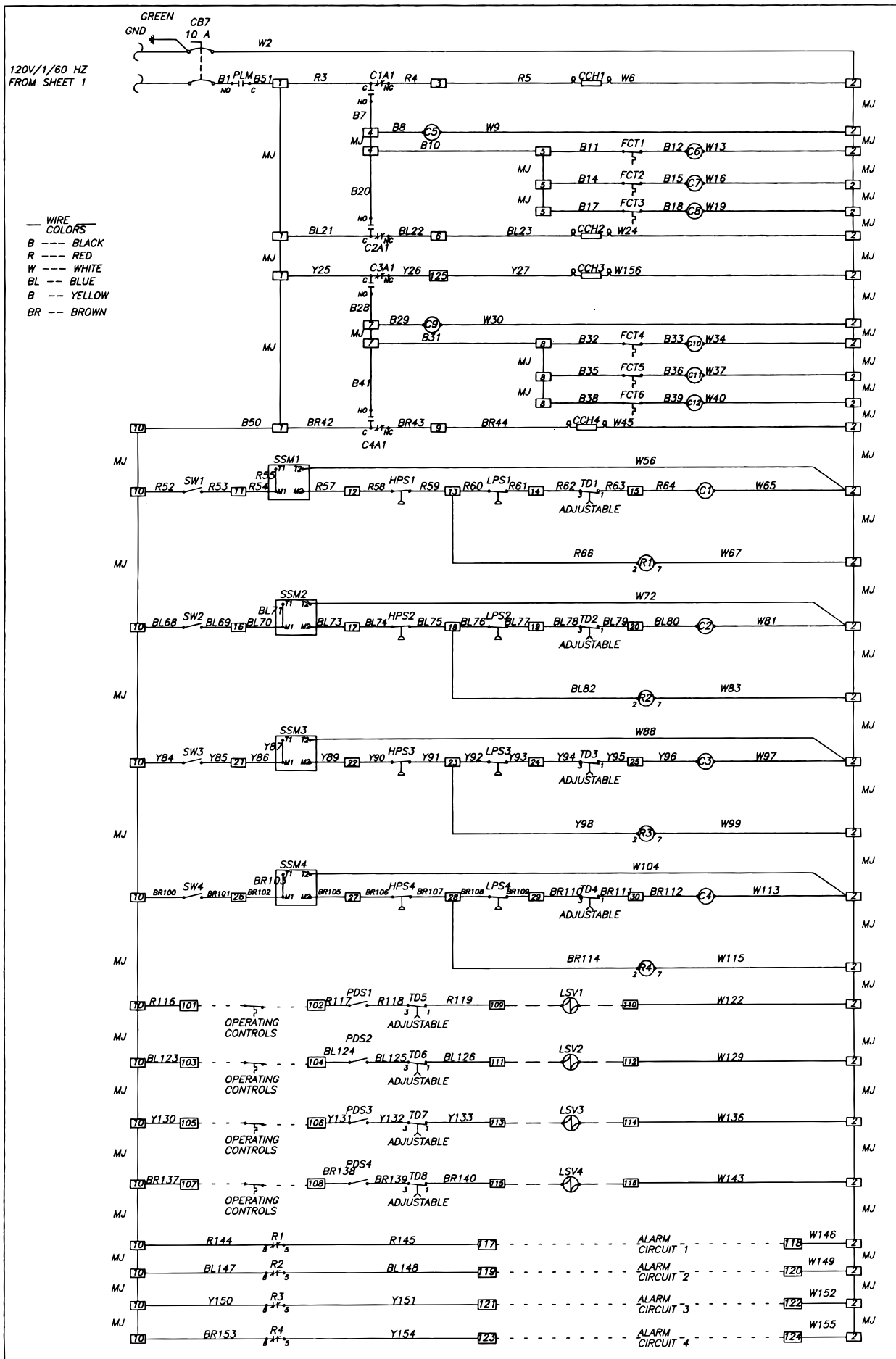

NOTE:
COMPRESSORS ARRANGED LEFT TO RIGHT LOOKING INTO COMPRESSOR CABINET. ZR12, ZR19, ZR16, ZR14, ZR12 & ZR19 USE LEFT HAND CONDENSER ZR16 & ZR16 USE RIGHT HAND CONDENSER

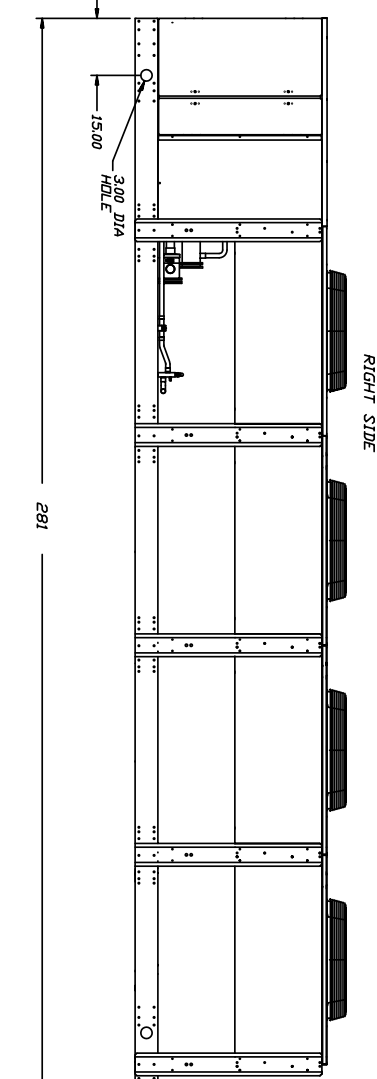
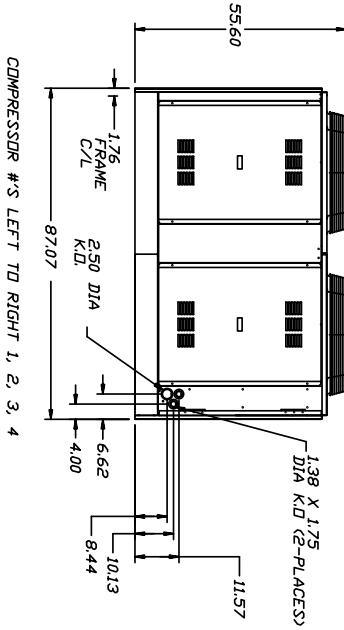

REV	DATE	BY	DESCRIPTION
A	9-16-02	HB	REVISED OPTIONS LIST
B	12-02-02	HB	REVISED UNIT MODEL NUMBER
C	02-26-03	HB	REVISED COMPRESSOR MODELS & MCA
D	05-01-03	HB	MOVED SOUND ATTENUATION KIT TO SPL ORDER
E	05-19-03	HB	ADDED MODEL BACUSID2CH1EQ INFORMATION
F	09-15-03	HB	ADDED COMPRESSOR LOCATION NOTES & CORRECTED ZR12 RLA & UNIT MCA

COMPRESSOR #'S LEFT TO RIGHT 1, 2, 3, 4

OPTIONS:

- SUPERHOSE HEATER
- CRANKCASE LIQUID DRIER
- REPL. CORE SUCTION FILTER
- FAN CYCLE (AMBIENT)
- PHASE MONITOR
- 115V CONTROL TRANSFORMER
- COMPRESSOR DRIP PAN
- P VERSION = PROKOTE COIL WITH SUBCOOL CIRCUIT
- E VERSION = ELECTRO-FIN COIL WITH SUBCOOL CIRCUIT
- C VERSION = COPPER-FIN COIL WITH SUBCOOL CIRCUIT
- COMPRESSOR FAN CIRCUIT BREAKER
- CONDENSER FAN CIRCUIT BREAKER
- HIGH PRESSURE CONTROL MANUAL RESET
- HIGH PRESSURE ALARM OUTPUTS
- 540 RPM FAN MOTORS

AVAILABLE AS SPECIAL ORDER
- SOUND ATTENUATION KIT

ABBREVIATIONS

- FLA --- FULL LOAD AMPS
- HP --- HORSEPOWER
- LRA --- LOCKED ROTOR AMPS
- MCA --- MINIMUM CIRCUIT AMPACITY
- MOPD --- MAX. OVERCURRENT PROTECTION DEVICE RATED LOAD AMPS

ALL DIMENSIONS SHOWN ARE PRELIMINARY AND SUBJECT TO CHANGE

ELECTRICAL CHARACTERISTICS

COMPRESSOR NUMBER	COMPRESSOR MODEL NO.	POWER SUPPLY	COMPRESSOR		CONDENSER FANS		UNIT	
			RLA	LRA	QTY.	HP (EAD)		FLA (EAD)
2	ZR19M3	208/3/60	55.2	42.5	8	1/2	203	250
3	ZR16M3	208/3/60	47.1	35.0				
4	ZR16M3	208/3/60	47.1	35.0				
1	ZR12M3	208/3/60	38.6	27.8				

MODEL	ESTIMATED SHIPPING WEIGHT
BACUSID2CH1EQ	6500 (LBS)
BACUSID2CH1EQ	8200 (LBS)

HEATCRAFT Inc.
REFRIGERATION PRODUCTS DIVISION
STONE MOUNTAIN, GEORGIA, U.S.A.

TITLE: SPECIFICATION SHEET
PRODUCT: BACUSID2CH1EQ AND EQ
FOOD LION

THIS DOCUMENT CONTAINS THE PROPERTY OF HEATCRAFT INC. AND IS TO BE USED ONLY FOR THE PROJECT AND FOR THE PERSON, FIRM OR COMPANY TO WHOM IT IS SPECIFICALLY APPLIED.

DATE	DATE	DATE	DATE
6-22-99	6-22-99	6-22-99	6-22-99
M/D	M/D	M/D	M/D
1	1	1	1

SHT. 1 OF 1

REV. F

DWG. NO. APB14467

NOTE:
 COMPRESSORS ARRANGED LEFT TO RIGHT LOOKING INTO
 COMPRESSOR CABINET, ZR12, ZR19, ZR19, ZR19,
 ZR12 & ZR19 USE LEFT HAND CONDENSER
 ZR19 & ZR19 USE RIGHT HAND CONDENSER

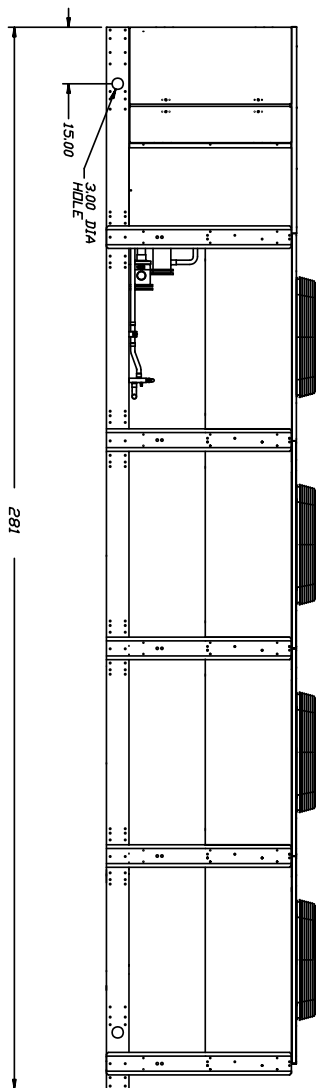
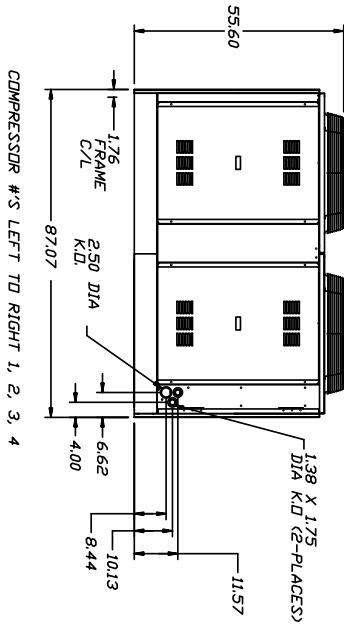

RIGHT SIDE

REV	DATE	BY	DESCRIPTION
A	9-16-02	HB	REVISED OPTIONS LIST
B	12-02-02	HB	REVISED UNIT MODEL NUMBER
C	05-01-03	HB	MOVED SOUND ATTENUATION KIT TO SPL ORDER
D	05-19-03	HB	ADDED MODEL BACUS9D2CHCQ INFORMATION
E	09-15-03	HB	ADDED COMPRESSOR LOCATION NOTES & CORRECTED ZR12 RLA

OPTIONS:

- SUPERHOSE HEATER
 - CRANKCASE LIQUID DRIER
 - REPL. CORE SUCTION FILTER
 - REPL. CORE (AMBIENT)
 - PHASE MONITOR
 - 115V CONTROL TRANSFORMER
 - COMPRESSOR DRIP PAN
 - P VERSION = PROTEGE COIL WITH SUBCOOL CIRCUIT
 - E VERSION = ELECTRO-FIN COIL WITH SUBCOOL CIRCUIT
 - C VERSION = COPPER-FIN COIL WITH SUBCOOL CIRCUIT
 - COMPRESSOR CIRCUIT BREAKER
 - CONDENSER FAN CIRCUIT BREAKER
 - HIGH PRESSURE CONTROL MANUAL RESET
 - 540 RPM FAN MOTORS
- AVAILABLE AS SPECIAL ORDER
 - SOUND ATTENUATION KIT

ALL DIMENSIONS SHOWN ARE PRELIMINARY AND SUBJECT TO CHANGE

ELECTRICAL CHARACTERISTICS

COMPRESSOR NUMBER	COMPRESSOR MODEL NO.	POWER SUPPLY	RLA	LRA	QTY.	HP (EAS)	FLA (EAS)	MCA	MDPD	UNIT
4	ZR19M3	208/3/60	55.2	425						
3	ZR19M3	208/3/60	55.2	425	8	1/2	3.5	218	250	
2	ZR19M3	208/3/60	55.2	425						
1	ZR12M3	208/3/60	38.6	278						

MODEL	ESTIMATED SHIPPING WEIGHT
BACUS9D2CHPQ	6500 (LBS)
BACUS9D2CHEQ	
BACUS9D2CHCQ	8700 (LBS)

ABBREVIATIONS

- FLA --- FULL LOAD AMPS
- HP --- HORSEPOWER
- LRA --- LOCKED ROTOR AMPS
- MCA --- MINIMUM CIRCUIT AMPCACITY
- MDPD --- MAX. OVERCURRENT PROTECTION DEVICE
- RLA --- RATED LOAD AMPS

HEATCRAFT Inc. REFRIGERATION PRODUCTS DIVISION STONE MOUNTAIN, GEORGIA, U.S.A.		TITLE SPECIFICATION SHEET	
THIS DOCUMENT CONTAINS MATERIAL PROPERTY OF HEATCRAFT INC. AND IS SUPPLIED ONLY ON A PROBABLY MADE TO ANY PERSON OR FIRM OR CORPORATION WITHOUT PRIOR WRIT- TEN APPROVAL.	DATE 6-22-99 MILD 6-22-99	PRODUCT BACUS9D2CH PA, EQ, CQ	DWG NO. APB14480
SHT. 1 OF 1		B	REV. E

Service Record

A permanent data sheet should be prepared on each refrigeration system at an installation, with a copy for the owner and the original for the installing contractor's files.

If another firm is to handle service and maintenance, additional copies should be prepared as necessary.

System Reference Data

The following information should be filled out and signed by Refrigeration Installation Contractor at time of start-up.

Date System Installed: _____

Installer and Address: _____

Condensing Unit

Unit Model#: _____

Unit Serial #: _____

Compressor Model #: _____ Compressor Model #: _____

Compressor Serial #: _____ Compressor Serial #: _____

Electrical _____ Volts _____ Phase _____

Voltage at Compressor L1 _____ L2 _____ L3 _____

Amperage at Compressor L1 _____ L2 _____ L3 _____

Notes

Notes

Since product improvement is a continuing effort,
we reserve the right to make changes in specifications without notice.

Visit us online at www.heatcraftrpd.com.

HEATCRAFT REFRIGERATION PRODUCTS LLC

2175 WEST PARK PLACE BOULEVARD • STONE MOUNTAIN, GA 30087 USA

770-465-5600 • FAX: 770-465-5990 WWW.HEATCRAFTRPD.COM



Free Manuals Download Website

<http://myh66.com>

<http://usermanuals.us>

<http://www.somanuals.com>

<http://www.4manuals.cc>

<http://www.manual-lib.com>

<http://www.404manual.com>

<http://www.luxmanual.com>

<http://aubethermostatmanual.com>

Golf course search by state

<http://golfingnear.com>

Email search by domain

<http://emailbydomain.com>

Auto manuals search

<http://auto.somanuals.com>

TV manuals search

<http://tv.somanuals.com>