

VBN2, VBN3 Control Ball Valve/Actuator Assemblies

INSTALLATION INSTRUCTIONS

INSTALLATION

When Installing this Product...

1. Read these instructions carefully. Failure to follow them could damage the product or cause a hazardous condition.
2. Check ratings given in the product data literature and on the product to ensure the product is suitable for your application.
3. Installer must be a trained, experienced, licensed service technician.
4. After installation is complete, check out product operation as provided in these instructions.

5. Stem rotation:
 - a. For two-way valves:
 - (1) Clockwise to close.
 - (2) Counterclockwise to open.
 - b. For three-way valves:
 - (1) Clockwise to increase B to AB flow.
 - (2) Counterclockwise to increase A to AB flow.
6. Valve must be mounted with the actuator/bracket above the valve body. Do not install the valve with the stem below horizontal or upside down. (See Fig. 1 and 2.)

Preparation



CAUTION

Equipment Damage Hazard.
Foreign particles like dirt and metal chips can damage the ball seals.
Clean upstream lines prior to installation.



CAUTION

Equipment Damage Hazard.
Improper chemicals can damage the valve.
Use neither aerosol products nor petroleum-based lubricants.

1. Clean the lines upstream of particles larger than 1/16 in. diameter. Open valves fully. Flush entire hydronic system of contaminants (welding slag, solder, scale, metal chips, etc.) and chemically treat water according to local conditions prior to operation.
2. Proceed with installation once the system specifics (expansion/contraction of the system and its medium as well as operating pressures) are within tolerances.
3. Eliminate air from system.
4. Two-way valves are marked to show flow direction.

IMPORTANT

Flow arrows must point in the direction of the flow for proper operation.

NOTE: For three-way valve mounting, see Fig. 3 through 5.

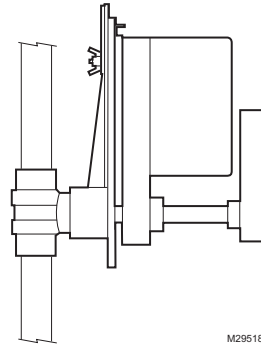

Fig. 1. Vertical valve installation.

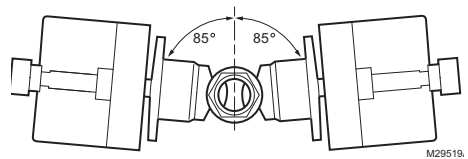

Fig. 2. Acceptable valve angle from vertical.



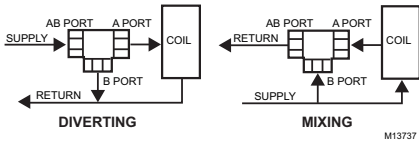

Fig. 3. Three-way ball valve flow orientation (not to scale).

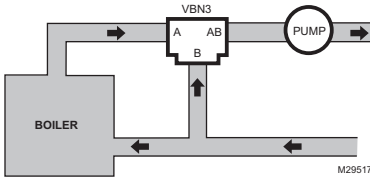

Fig. 4. Reset mixing control for discharge hot water.

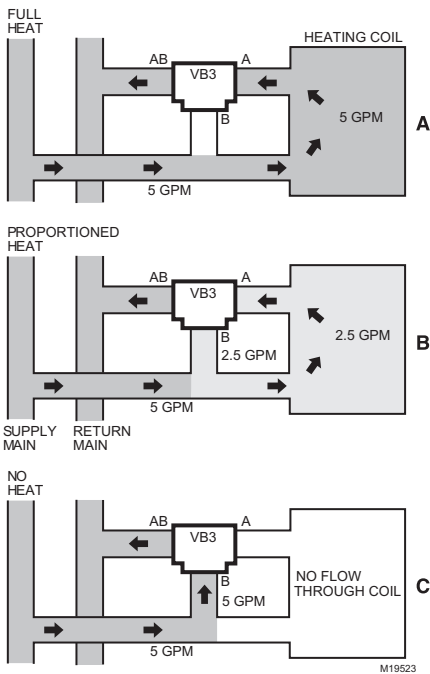

Fig. 5. Three-way mixing valve operation with coil bypass.

Mechanical Installation

The valves have female NPT pipe fittings and should be sealed with an approved pipe sealant or tape. Take care not to use excess pipe dope to avoid interfering with operation of ball. Torque should not exceed 75 ft-lb.

See Fig. 8 and 9 for valve dimensions. Refer to actuator literature for actuator dimensions.

Mounting Plate Adjustment

The Actuator Mounting Plate can be rotated to a different position for installation in confined spaces. This is accomplished as follows:

1. Remove the handle from the shaft and set it aside.
2. Remove the two screws that hold the stem assembly to the mounting plate and set them aside.
3. Remove and set aside the stem assembly.
4. Remove and set aside the two screws that attach the mounting plate to the valve.
5. ENSURE VALVE IS ISOLATED AND DEPRESSURIZED BEFORE PROCEEDING. Remove yellow pressure plate marked "HIGH PRESSURE" from valve bonnet, rotate 90° or 180°, and re-install screws using same holes in pressure plate and the appropriate pair of tapped holes in the valve bonnet.

NOTE: Take note of the screw hole positions on the valve. They limit the mounting plate positions.

6. Rotate mounting plate around valve top to the desired position.

IMPORTANT

Do not rotate the valve stem while the hold-down ring is removed. This can change the common port from AB to A.

7. Lower ring down to valve body and engage it in the new position relative to the mounting plate.
8. Tighten screws to valve body securing the mounting plate.
9. Reattach the stem assembly to the mounting plate.
10. If desired, replace the handle on the shaft.

NOTE: See Fig. 6 for valve exploded view.

IMPORTANT

After adjusting a three-way valve mounting plate, take note whether the AB port or the A port is the common port.

Electrical Installation

1. If necessary, remove actuator wiring cover.
2. Wire the actuator according to the appropriate diagram provided with actuator or job specifications. For detailed actuator information, see Honeywell literature:
 - 62-0274—MS7505/MS8105 Spring Return Actuator Installation Instructions
 - 63-2632—MN6105 Floating Actuator Product Data
 - 63-2633—MN7505 Modulating Actuator Product Data
 - 63-2209—ML6161/ML6164/ML7161/ML7164 Non-spring return direct Coupled Actuators Product Data
3. If applicable, position reverse/direct acting switch for desired operation.
4. Replace cover.

OPERATION AND CHECKOUT

Once both the mechanical and electrical installations are complete:

1. Cycle the actuator to verify that the direction of rotation suits the control sequence.
2. If the rotation direction is incorrect:
 - a. For 2-position control actuators: Remount actuator on the bracket.
 - b. For floating control actuators: Reverse two control signal wires (CW/CCW).
 - c. For analog control actuators either:
 - (1) Reposition reverse/direct acting switch, or
 - (2) Remount actuator on the bracket.
3. If the control scheme requires fail-safe operation, ensure that, upon removal of power, the valve rotates to the desired position.
4. Spring return actuators are factory-configured for A-port normally-closed fail-safe operation. To change this to normally-open, remove and reinstall the actuator in the opposite orientation as follows:
 - (a) Loosen the shaft coupling bolt using a 10 mm wrench.
 - (b) Loosen all other mounting bolts connecting the actuator to the mounting bracket, and set aside.
 - (c) Remove the actuator from the valve shaft.
 - (d) Move the actuator shaft coupling to the opposite side of the actuator, as displayed in Figure 7.

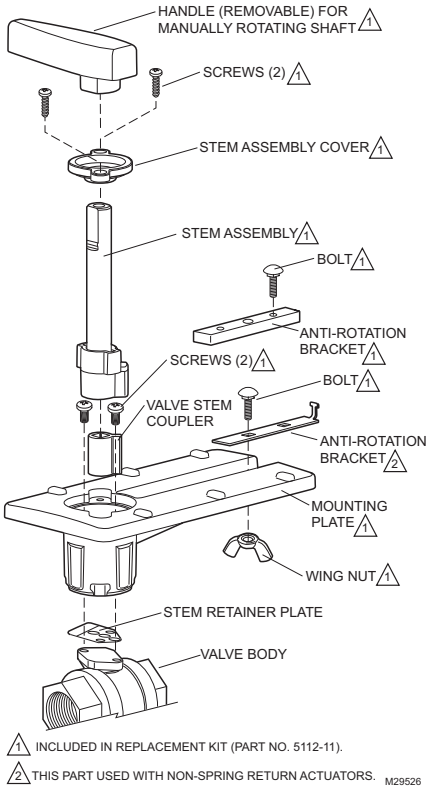

Fig. 6. Valve assembly exploded view.

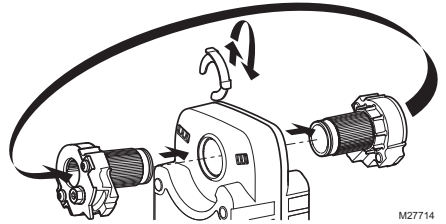
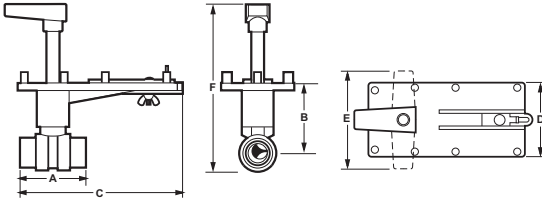

Fig. 7. SCSA Mounting

For detailed actuator information, see Honeywell forms:
 — 63-2209 ML6161, ML7161 Product Data Sheet.
 — 63-2607 S05, S10, S20 Series Actuator Product Data Sheet.

VB2, VB3 CONTROL BALL VALVE/ACTUATOR ASSEMBLIES



PIPE SIZE		Cv	DESIGNATORS	DIMENSIONS IN INCHES (mm)						WEIGHT		REPLACEMENT STEM ASSEMBLY
IN.	DN			A	B	C	D	E	F	LB	KG	
1/2	15	VB2A.	B,D,E,F,G,H,K	2-3/8 (60)	2-3/4 (70)	6-5/8 (168)	3	8-1/8 (206)	2	2.4 (1.1)	5112-19 5112-22 (SS)	
			J	2-5/8 (67)	2-7/8 (73)	6-1/2 (165)						8-5/16 (211)
3/4	20	VB2B.	B,D,E,G,H,J,L,△	2-3/4 (70)	2-7/8 (73)	6-7/16 (163)	3	8-1/8 (206)	2	2.4 (1.1)	5112-20 5112-23 (SS)	
			K,M,△									2-7/8 (73)
1	25	VB2C.	J	2-3/4 (70)		7-1/16 (179)	3	8-11/16 (221)	2	2.4 (1.1)	5112-21 5112-24 (SS)	
			H,L,P,△	3-1/16 (78)	3-1/16 (78)	6-3/4 (171)						8-11/16 (221)
1-1/4	30	VB2D.	H,J,K,L,N,△	3 (76)	3-1/8 (78)	6-11/16 (170)	3	8-11/16 (221)	2	2.4 (1.1)	5112-20 5112-23 (SS)	
			M,S,△	3-5/8 (92)	3-1/4 (82)	7 (178)						8-11/16 (221)
1-1/2	40	VB2E.	L,M,R,△	3-7/16 (87)		8-15/16 (176)	3	8-7/8 (225)	2	2.4 (1.1)	5112-21 5112-24 (SS)	
			N,T,△	4-1/16 (103)	3-3/4 (95)	7-1/16 (180)						8-7/8 (225)
2	50	VB2F.	N,T,△	4 (102)		7-3/16 (183)	3	10-1/2 (267)	3	3.2 (1.5)	5112-21 5112-24 (SS)	
			P,R,S,1,2,△	4-15/16 (125)	4-1/16 (103)	7-7/16 (189)						10-1/2 (267)
2-1/2	65	VB2G.	N,P,R,S,U,1,△	5-9/16 (135)		7-9/16 (192)	3	10-11/16 (271)	3	3.8 (1.7)	5112-21 5112-24 (SS)	
			N,P,R,T,U,△	5-3/4 (146)		7-11/16 (195)						10-11/16 (271)

△ INDICATES FULL PORT VALVE: NO FLOW CHARACTERIZING INSERT.
 2 WILL BE SHORTER WITH NON-SPRING-RETURN ACTUATORS.

M31359

Fig. 8. VB2 dimensions in inches (mm).

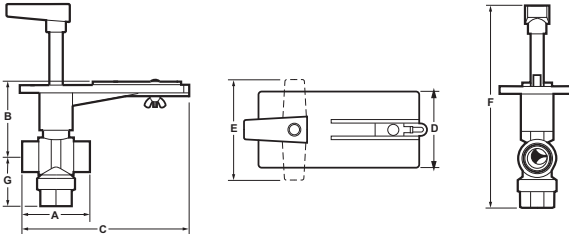

PIPE SIZE		Cv	DESIGNATORS	DIMENSIONS IN INCHES (mm)						WEIGHT		REPLACEMENT STEM ASSEMBLY
IN.	DN			A	B	C	D	E	F	G	LB	
1/2	15	VB2A.	B,D,E,F,H,J	3-1/2 (89)		7 (178)	3	9-3/8 (238)	2 (51)	2.4 (1.1)	5112-19	
			C,D,E,F,G,K,△	2-13/16 (71)	3-5/16 (84)	6-1/2 (165)						8-13/16 (224)
3/4	20	VB2B.	C,D,E,F,G,K,△	2-13/16 (71)	3-5/16 (84)	6-1/2 (165)	3	9-1/2 (241)	2-1/16 (52)	2.0 (0.9)	5112-20	
			C,D,E,F,G	3-13/16 (87)		7-5/16 (186)						8-1/2 (211)
1	25	VB2C.	J,L	3 (76)	3-13/16 (87)	6-13/16 (173)	3	9-13/16 (249)	2-7/16 (62)	2.6 (1.2)	5112-21	
			H,K,M	4-5/16 (110)	4 (102)	7-13/16 (198)						10-13/16 (275)
1-1/4	30	VB2D.	H,J,L,△	3 (76)	3-13/16 (87)	6-13/16 (173)	3	9-13/16 (249)	2-13/16 (71)	2.4 (1.1)	5112-21	
			K,M,N,△	3-5/8 (92)	4 (102)	7-5/16 (186)						10-5/16 (262)
1-1/2	40	VB2E.	H,K,M,△	4-5/16 (110)		7-13/16 (198)	3	10-13/16 (275)	2-3/4 (70)	3.3 (1.5)	5112-21	
			L,P	4 (102)	4-1/2 (114)	7-5/16 (186)						11 (279)
2	50	VB2F.	L,N,P		4-1/2 (114)	7-5/16 (186)	3	12-5/16 (313)	3-1/8 (79)	3.8 (1.7)	5112-21	
			R,T	5 (127)	5-13/16 (148)	7-13/16 (198)						4-1/8 (105)

△ INDICATES FULL PORT VALVE: NO FLOW CHARACTERIZING INSERT.

M31360

Fig. 9. VB3 dimensions in inches (mm).

Automation and Control Solutions

Honeywell International Inc.
 1985 Douglas Drive North
 Golden Valley, MN 55422
<http://customer.honeywell.com>

Honeywell Limited-Honeywell Limitée
 35 Dynamic Drive
 Toronto, Ontario M1V 4Z9
<http://customer.honeywell.ca>



® U.S. Registered Trademark
 © 2010 Honeywell International Inc.
 62-0197-04 E.K. Rev. 04-10

Printed in U.S.A.

Free Manuals Download Website

<http://myh66.com>

<http://usermanuals.us>

<http://www.somanuals.com>

<http://www.4manuals.cc>

<http://www.manual-lib.com>

<http://www.404manual.com>

<http://www.luxmanual.com>

<http://aubethermostatmanual.com>

Golf course search by state

<http://golfingnear.com>

Email search by domain

<http://emailbydomain.com>

Auto manuals search

<http://auto.somanuals.com>

TV manuals search

<http://tv.somanuals.com>