

HMLCD17L, HMLCD19L

L-Series LCD Monitor

User Manual

Revisions

Issue	Date	Revisions
A	Sept 2007	Initial Release

FCC COMPLIANCE STATEMENT

Information to the User: This equipment has been tested and found to comply with the limits for a Class B digital device, pursuant to part 15 of the FCC rules. This equipment generates, uses, and can radiate radio frequency energy and, if not installed and used in accordance with the instruction manual, may cause harmful interference to radio communications. This device complies with Part 15 of the FCC rules. Operation is subject to the following conditions:

- The device may not cause harmful interference.
- This device must accept any interference received, including interference that may cause undesired operation.

These limits are designed to provide reasonable protection against harmful interference in a residential installation. However, there is no guarantee that interference will not occur in a particular installation. If this equipment does cause harmful interference with radio or television reception, which can be determined by turning the equipment off and on, you are encouraged to try to correct the interference by one or more of the following measures:

- Reorient the receiving antenna.
- Relocate the system with respect to the receiver.
- Move the system away from the receiver.
- Plug the system into a different outlet so that the system and the receiver are on different branch circuits.

If necessary, consult a representative of Honeywell Inc. or an experienced radio/television technician for additional suggestions.

The following information is provided on the device or devices covered in this document in compliance with the FCC regulations:

- Product name:
- Model number:
- Company name:

CAUTION: Changes or modifications not expressly approved by the party responsible for compliance could void the user's authority to operate the equipment.

IMPORTANT SAFETY INSTRUCTIONS

READ INSTRUCTIONS - All safety and operating instructions should be read before the unit is operated.

1. The safety and operating instructions should be retained for future reference.
2. Do not store or use the LCD monitor in locations that are exposed to heat, direct sunlight, or extreme cold.
3. Avoid moving the LCD monitor between locations with large temperature differences.
4. Do not subject the LCD monitor to severe vibration or high impact conditions. For example, do not place the LCD monitor inside a car trunk.
5. Keep flat panel monitor in room temperature conditions. Excessive cold or hot conditions can have an adverse effect on the liquid crystal of the display.

6. Never insert anything metallic into the monitor openings. Doing so may create the danger of electric shock.
7. To avoid electric shock, never touch the inside of the monitor. Only a qualified technician should open the monitor case.
8. Never use your monitor if the power cable has been damaged. Do not allow anything to rest on the power cable. Keep the power cable away from where people could trip over it.
9. Be sure to grasp the plug, not the cable, when disconnecting the monitor from an electric outlet.
10. Openings in the monitor cabinet are provided for ventilation. To prevent overheating, these openings should not be blocked or covered. Avoid using the monitor on a bed, sofa, rug, or other soft surface, as doing so may block the ventilation openings in the bottom of the cabinet. If you place the monitor in a bookcase or an enclosed space, be sure to provide adequate ventilation and air flow.
11. Place your monitor in a location with low humidity and minimum dust. Avoid places similar to a damp basement or dusty hallway.
12. Do not expose the monitor to rain or use it near water (in kitchens, next to swimming pools, etc.). If the monitor accidentally gets wet, unplug it and contact an authorized dealer immediately. You can clean the monitor with a damp cloth when necessary, being sure to unplug the monitor first.
13. Place the monitor on a solid surface and treat it carefully. The screen is made of glass and can be damaged if dropped or hit sharply.
14. Locate your monitor near an easily accessible electric outlet.
15. If your monitor does not operate normally - in particular, if there are any unusual sounds or smells coming from it - unplug it immediately and contact an authorized dealer or service center.
16. Do not attempt to remove the back cover while the monitor is plugged into an electric outlet, as you will be exposed to an electrical shock hazard. The back cover should only be removed by qualified service personnel.
17. Unplug the monitor when it is going to be left unused for an extended period of time.
18. Hg Lamp(s) inside this product contains mercury and must be recycled or disposed of according to local, state or federal laws. For more information, contact the electronic industries alliance: <http://www.eiae.org>.

Contents

Controls and Functions	11
OSD Menu	13
Power Management	17
Specifications and Parts	18
Troubleshooting	21

Figures

Figure 1	Front panel controls	11
Figure 2	Back panel connectors	12
Figure 3	Color settings	13
Figure 4	Picture settings	14
Figure 5	Function settings	14
Figure 6	OSD Menu settings	15
Figure 7	Misc settings	15
Figure 8	Monitor dimensions	18

Figures

Tables

Table 1	Power Consumption	17
Table 2	LED Indicator	17
Table 3	Specifications list	19
Table 4	Pre-Set Display Mode	19
Table 5	Parts list	20

Tables

Controls and Functions

The HMLCD17L and HMLCD19L monitors include the following features:

- OSD menu
- MPR II certified
- DDC1 and DDC2 plug and play functionality
- Full range power supply that auto adjusts to accept AC 100V to 240V and 50Hz to 60Hz

Front Panel Controls

Figure 1 Front panel controls

HMLCD17L

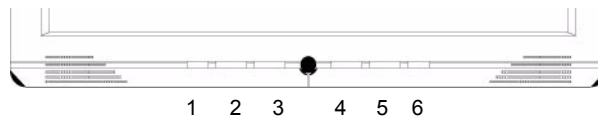

HMLCD19L

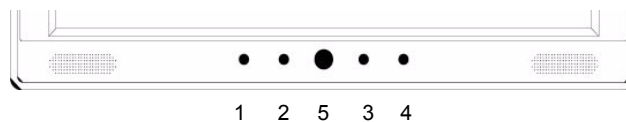

1. AUTO button
2. OSD t button
3. OSD s button
4. OSD MENU button
5. Power switch
6. LED Power indicator

Back Panel Controls

Figure 2 Back panel connectors

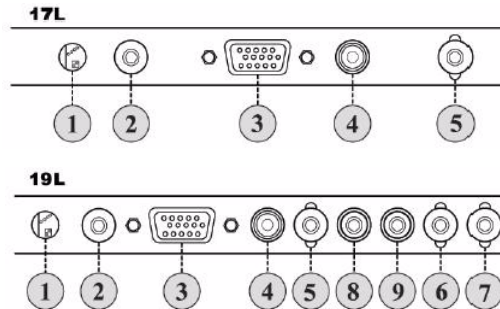

1. Audio-in
2. DC power-in
3. VGA-in (D-Sub connector)
4. Video-in (RCA)
5. Video2-in (BNC)
6. Video3-in (BNC)
7. Video3-loop-out (BNC)
8. Audio-in-Right (Video mode)
9. Audio-in-left (Video mode)

How to Install the Power Cable:

1. Plug the AC/DC adapter into the DC power-in.
2. Connect the AC power cable to the adapter.
3. Connect the VGA cable to the D-Sub connector.
4. Plug the AC power cable connector into an AC power outlet.

OSD Menu

Using the menu:

There are two options for configuring the Monitor display: AUTO and MENU. Press AUTO to configure the monitor automatically without user input. Press MENU to enable the monitor to be configured using the OSD menus described below.

To scroll through the main menu and select sub menu options use the s and t buttons on the front panel of the monitor.

To change a menu setting use the \oplus and \ominus options.

Color:

Figure 3 Color settings

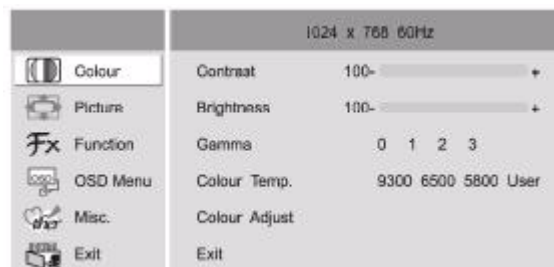

Contrast

Increase or decrease the intensity (lightness or dimness) of the image.

Brightness

Increase or decrease the intensity of the image.

Gamma

Adjusts the level of the screen image.

Color Temp.

Select from 9300, 6500, 5800 degrees or a user defined value.

Color Adjust

Adjust the Red, Green and Blue colors for the monitor.

Picture:

Figure 4 Picture settings

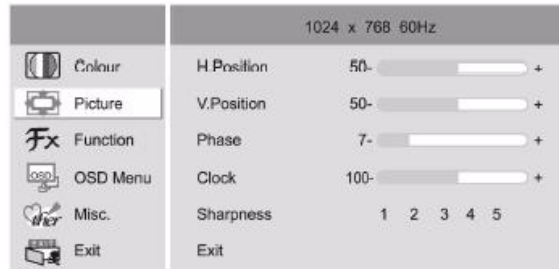

H Position

Move the picture horizontally on the screen right and left.

V Position

Move the picture vertically on screen up and down.

Phase

Adjust the number of horizontal picture elements.

Clock

Adjust the vertical noise of the screen image.

Sharpness

Adjust background black level of the screen image.

Function:

Figure 5 Function settings

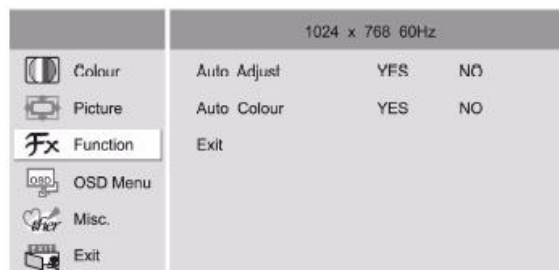

Auto Adjust

Select whether to enable the auto adjust feature of the monitor.

Auto Color

Select whether to enable the auto color feature of the monitor.

OSD Menu:

Figure 6 OSD Menu settings

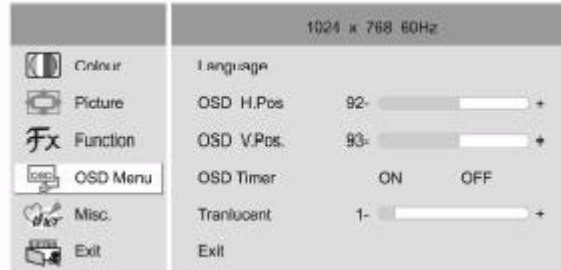

Language

Select the required supported language from the list.

OSD H. Position

OSD window horizontal position adjustment.

OSD V. Position

OSD window vertical position adjustment.

OSD Timer

Set the OSD screen standby time.

Translucent

Set the translucency of the OSD.

Misc:

Figure 7 Misc settings

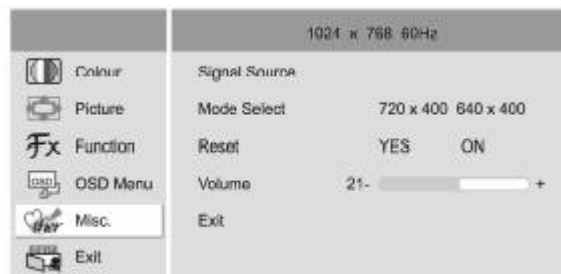

Signal Source

Select the signal source for the monitor.

Mode Select

Select the screen resolution.

Reset

Selecting YES restores the factory defaults for the monitor.

OSD Menu

Volume
Adjust the monitor audio volume.

Power Management

The power management function for this monitor is controlled by the computer to which it is connected. This monitor enters an appropriate mode as designated by the computer. The stage that the power management system is in is indicated by the LED on the monitor.

Table 1 Power Consumption

Mode	Power Consumption
ON	50W or less
STANDBY	3W or less
SUSPEND	3W or less
ACTIVE OFF	3W or less

Table 2 LED Indicator

Mode	LED Color	Monitor Operation
ON	Green	Normal operation.
STANDBY SUSPEND ACTIVE OFF	Yellow	Screen blanks after preset idle time and some electronic circuits or all circuitry in the monitor shut down.
POWER OFF	Orange	Not in operation.

Specifications and Parts

Figure 8 Monitor dimensions

HMLCD17L

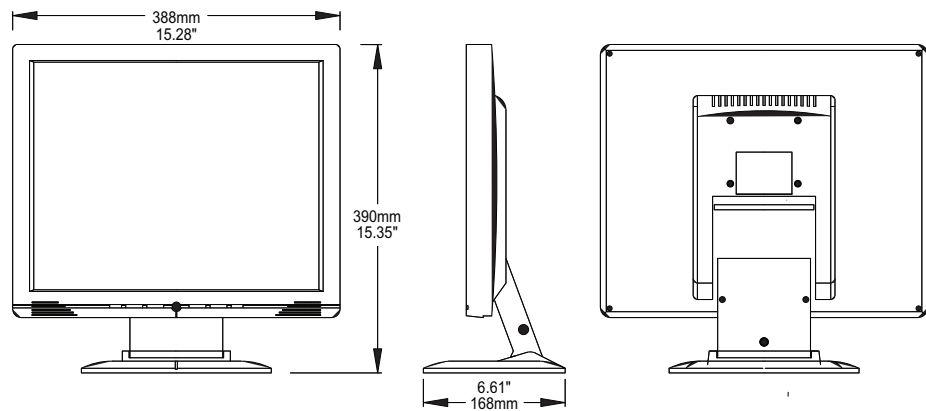

HMLCD19L

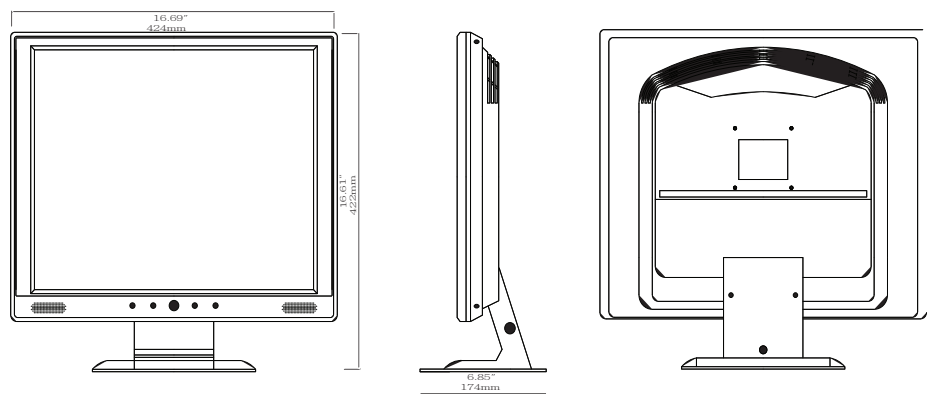

Table 3 Specifications list

Parameter	Description
LCD Type	Pixel pitch(mm): 0.264(H) 0.264(W) Maximum Pixel Rate: 100MHz Display Color: 16.7 M Viewing Angle: 85/85(H) 70/70(V)
Resolution (H x V)	1280 x 1024 @ 60Hz
Frequency	Horizontal: 31-81KHz Vertical: 56-75Hz
Input Signal	Analog RGB(0.7Vp-p, 75Ω ohms) D-Sub / BNC / RCA
Active Display Area (W x H)	17": 337.9mm(13.3") x 270.3mm(10.6") 19": 376.3mm(14.8") x 301mm(11.9")
Dimensions (W x H x L)	17": 400mm(15.7") x 385mm(15.2") x 160mm(6.3") 19": 430mm(16.9") x 425mm(16.7") x 160mm(6.3")
Weight	17": Net Weight 5kg(11lb) Gross Weight 7kg(15.4lb) 19": Net Weight 5.4kg(11.9lb) Gross Weight 7kg(15.4lb)
Power Supply	AC 100 – 240V, 50 – 60Hz DC 12V/ 5.0A
Power Consumption	Maximum: 50 Watts Standby: <3 Watts
Environment	Temperature: 41 to 104 deg F (5 to 40 deg C) Humidity: 20 to 85% RH

Table 4 Pre-Set Display Mode

Mode	Resolution	Horizontal Frequency	17"	19"
1	640 x 350	31.5 KHz / 70.1 KHz	v	v
2	720 x 400	31.5 KHz / 70.1 KHz	v	v
3	640 x 480	31.5 KHz / 60.0 KHz	v	v
4	640 x 480	37.9 KHz / 75.0 KHz	v	v
5	640 x 480	37.5 KHz / 75.0 KHz	v	v
6	640 x 480	43.3 KHz / 85.0 KHz	v	v
7	800 x 600	35.2 KHz / 56.3 KHz	v	v
8	800 x 600	37.8 KHz / 60.3 KHz	v	v
9	800 x 600	48.0 KHz / 72.2 KHz	v	v
10	800 x 600	46.9 KHz / 75.0 KHz	v	v
11	1024 x 768	48.2 KHz / 60.0 KHz	v	v

Table 4 Pre-Set Display Mode

Mode	Resolution	Horizontal Frequency	17"	19"
12	1024 x 768	56.5 KHz / 70.1 KHz	v	v
13	1024 x 768	60.0 KHz / 75.01 KHz	v	v
14	1280 x 1024	64.6 KHz / 59.9 KHz	v	v
15	1280 x 1024	80.05 KHz / 75.0 KHz	v	v

Table 5 Parts list

Part	Quantity
LCD Monitor	1
AC Power Cable	1
Audio Cable	1
VGA Cable	1
DC Power Adapter	1
User Manual	1

Note: technical specifications and parts are subject to change without notice.

Troubleshooting

Issue: No image is displayed on screen.

- Possible Solution:**
- Check that the power cord has been connected securely into the wall outlet or grounded extension cable or surge protector.
 - Power switch should be in the ON position and the LED should be lit.
 - Check that the Brightness and the Contrast adjustments have not been turned down to the minimum levels.
 - Check if the monitor is in no data status mode. If it is the LCD will appear yellow.
 - When the signal is from a laptop computer check if it changes the signal to external mode.

Issue: 'Going to Sleep' message displayed on screen.

- Possible Solution:**
- The signal cable should be fully connected to the video card/computer.
 - The video card should be completely sealed in the slot and the computer is switched ON.

Issue: Display image is not centered, too small or too large in PC mode.

Possible Solution: Push the down key on the front of the monitor or the Auto button on the remote control.

Issue: Vertical or Horizontal noise is present in the picture.

- Possible Solution:**
- Power supply is insufficient. Connect to another power supply.
 - Remove any objects that may be producing a magnetic field around the monitor, such as a radio, amplifier without a cover, fluorescent tube, AC switch or desk fan.
 - Press Auto-Setup key to improve graphic quality.

Issue: Faulty or Abnormal Color displayed on screen

Possible Solution: If red, green or blue are not displayed on the screen, check whether the display cable is properly connected.

Issue: Sync problem between the monitor and PC

Possible Solution:

- Check if the display input signal is within the specified range (56 - 75 Hz).
- Ensure the display signal cable is connected properly between the monitor and the PC.

NOTES:

Honeywell Video Systems (Head Office)

2700 Blankenbaker Pkwy, Suite 150
Louisville, KY 40299, USA
www.honeywellvideo.com
' +1.800.796.2288

Honeywell Security Australia Pty Ltd.

Unit 5, Riverside Centre, 24-28 River Road West
Parramatta, NSW 2150, Australia
www.ademco.com.au
' +61.2.8837.9300

Honeywell Security Asia Pacific

33/F Tower A, City Center, 100 Zun Yi Road
Shanghai 200051, China
www.security.honeywell.com/cn
' +86 21.2527.4568

Honeywell Security Asia

Flat A, 16/F, CDW Building, 388 Castle Peak Road
Tsuen Wan, N.T., Hong Kong
www.security.honeywell.com/hk
' +852.2405.2323

Honeywell Security France

Parc Gutenberg, 8, Voie La Cardon
91120, Palaiseau, France
www.honeywell.com/security/fr
' +33.01.64.53.80.40

Honeywell Security Italia

Via della Resistenza 53/59
20090 Buccinasco Milan, Italy
www.honeywell.com/security/it
' +39.02.48.88.05.51

Honeywell Security España

Mijancas 1. 3ª Planta
P.Ind. Las Mercedes
28022 Madrid, Spain
www.security.honeywell.com/es
' +34.902. 667.800

Honeywell Video Systems Northern Europe

Netwerk 121
1446 WV Purmerend, The Netherlands
www.SecurityHouse.nl
' +31.299.410.200

Honeywell Video Systems UK Ltd.

Aston Fields Road, Whitehouse Ind Est
Runcorn, Cheshire, WA7 3DL, UK
www.honeywellvideo.com
' +0844 8000 235

Honeywell Security South Africa

Unit 6 Galaxy Park, 17 Galaxy Avenue
Linbro Park, P.O. Box 59904
2100 Kengray, Johannesburg, South Africa
www.honeywell.co.za
' +27.11.574.2500

Honeywell Security Deutschland

Johannes-Mauthe-Straße 14
D-72458 Albstadt, Germany
www.honeywell.com/security/de
' +49.74 31.8 01.0

Honeywell Security Poland

Chmielewskiego 22a, 70-028
Szczecin, Polska
www.ultrak.pl
' +48.91.485.40.60

Honeywell Security Czech Republic

Havránkova 33, Brno
Dolní Heršpice, 619 00, Czech Republic
www.olympo.cz
' +420.543.558.111

Honeywell Security Slovakia Republic

Vajnorská 142, 83104 Bratislava
Slovakia
www.olympo.sk
' +421.2.444.54.660

Honeywell

www.honeywellvideo.com
+1.800.796.CCTV (North America only)
HVSsupport@honeywell.com

Document 800-00945 09/07 Rev A

© 2007 Honeywell International Inc. All rights reserved. No part of this publication may be reproduced by any means without written permission from Honeywell Video Systems. The information in this publication is believed to be accurate in all respects. However, Honeywell Video Systems cannot assume responsibility for any consequences resulting from the use thereof. The information contained herein is subject to change without notice. Revisions or new editions to this publication may be issued to incorporate such changes.

Free Manuals Download Website

<http://myh66.com>

<http://usermanuals.us>

<http://www.somanuals.com>

<http://www.4manuals.cc>

<http://www.manual-lib.com>

<http://www.404manual.com>

<http://www.luxmanual.com>

<http://aubethermostatmanual.com>

Golf course search by state

<http://golfingnear.com>

Email search by domain

<http://emailbydomain.com>

Auto manuals search

<http://auto.somanuals.com>

TV manuals search

<http://tv.somanuals.com>