

Honeywell

HRHD 410

4-Channel Digital Video Recorder

User Guide

Revisions

Issue	Date	Revisions
1.00	11/04	New document.
1.01	04/05	Update template, styles and contact information.
2.00	07/05	Add Waste Electrical Equipment warning.
3.00	09/05	<p>Added new subsections in Chapter 3, Configuration:</p> <ul style="list-style-type: none">• Time Sync to Date/Time Setup• Text-In (Generic) and Text-In (E-POS) to Text-In Setup• LAN - DHCP and LAN - ADSL (PPPoE) to LAN Setup• DVRNS Setup <p>Added new subsections in Chapter 4, Operations:</p> <ul style="list-style-type: none">• Text-In Search to Searching Video• Set Speed to PTZ Mode• Text-In Search <p>Added new Appendix: Text-In Query Examples</p> <p>Added new figures: Time Sync, Text-In (Generic Text) Setup, Text-In (E-POS) Setup, Port Number Setup, LAN (DHCP) Setup, LAN (ADSL) Setup, DVRNS Setup, Disk Partition Selection, Live Monitoring (Text-In), Text-In Log, Text-In Search.</p> <p>Revised figures: Quick Setup, System Information, System Information Change, Date/Time Setup, System Check, Text-In Setup, Record Mode Setup, Text-In Event Action (Record) Setup, Text-In Event Action (Alarm Out) Setup, Text-In Event Action (Notify) Setup, OSD Setup, LAN (Manual) Setup, Callback Center Setup (LAN), Callback Center Setup (Modem), Search menu, Event Search by Event, Event Search by Camera.</p> <p>Minor changes throughout</p>
3.01	10/05	Added to Package Contents, minor changes to Operations chapter.
3.02	11/05	Updated Package Contents and Storage specifications.
3.03	02/07	Inserted Load/Save setup feature. Updated Record Mode setup, System Check, Callback Center Setup and Text In setup options.

FCC Compliance Statement

INFORMATION TO THE USER: This equipment has been tested and found to comply with the limits for a Class A digital device, pursuant to part 15 of the FCC rules. These limits are designed to provide reasonable protection against harmful interference when the equipment is operated in a commercial environment. This equipment generates, uses, and can radiate radio frequency energy and, if not installed and used in accordance with the instruction manual, may cause harmful interference to radio communications. Operation of this equipment in a residential area is likely to cause harmful interference in which case the user will be required to correct the interference at his own expense.

CAUTION: Changes or modifications not expressly approved by the party responsible for compliance could void the user's authority to operate the equipment.

This Class A digital apparatus complies with Canadian ICES-003.

Cet appareil numérique de la Classe A est conforme à la norme NMB-003 du Canada.

Explanation of Graphical Symbols



This symbol alerts the user to the presence of uninsulated dangerous voltage within the product's enclosure that may be of sufficient magnitude to constitute a risk of electric shock.



This symbol alerts the user to the presence of important operating and maintenance (servicing) instructions in the literature accompanying the appliance.

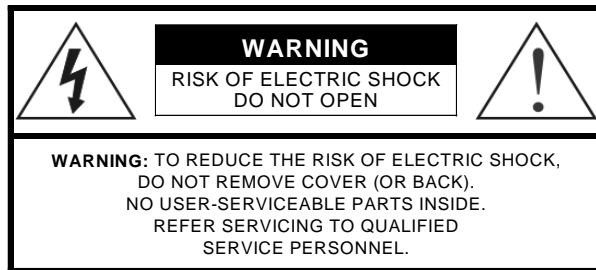

WEEE (Waste Electrical and Electronic Equipment)

Correct Disposal of this Product (Applicable in the European Union and other European countries with separate collection systems)



This marking shown on the product or its literature, indicates that it should not be disposed with other household wastes at the end of its working life. To prevent possible harm to the environment or human health from uncontrolled waste disposal, please separate this from other types of wastes and recycle it responsibly to promote the sustainable reuse of material resources.

Household users should contact either the retailer where they purchased this product, or their local government office, for details of where and how they can take this item for environmentally safe recycling.

Business users should contact their supplier and check the terms and conditions of the purchase contract. This product should not be mixed with other commercial wastes for disposal.

Contents

FCC Compliance Statement	i
Explanation of Graphical Symbols	ii
WEEE (Waste Electrical and Electronic Equipment).	ii
About This Document.	xiii
Overview of Contents.	xiii
Important Safeguards	xiv
1 Introduction	1
Features	1
Technical Overview.	2
2 Installation	5
Package Contents	5
Required Installation Tools	5
Connecting the Video Source	6
Connecting the Loop Through Video	6
Connecting Audio	7
Setting Unit for CVBS (SVHS) or VGA Output	8
Connecting the Monitor	9
Connecting the Spot Monitor.	9
Connecting the RGB Monitor.	9
Connecting to the Network Port	10
Connecting to the RS232C Port	10
Factory Reset	11
Connecting Alarms	12
AI 1 to 4 (Alarm In)	12
GND (Ground)	12
ARI (Alarm Reset In)	13
Alarm Out	13
Connecting to the RS485 Port	13
Connecting to the USB Port	14
Connecting the Power Cord	14
3 Configuration	17
Front Panel Controls	17
Turning on the Power.	20
Initial Unit Setup	20
Quick Setup Screen	21
Normal Setup Screen.	23
System Information	23
Date/Time Setup	26

Contents

System Check Screen	29
Storage Screen	31
System Log Screen	33
System Shutdown	33
Configuring Input Devices	34
Camera Setup Screen	34
Alarm In Setup Screen	35
Motion Detector	36
Text In Setup Screen	37
Alarm Out Setup Screen	40
Audio Setup Screen	41
RS232/RS485 Setup Screen	42
Configuring Recording Settings	44
Record Mode Setup Screen	44
Time-Lapse Record Mode Setup Screen	46
Time-Lapse Recording Schedule	47
Pre-Event Recording Setup Screen	48
Event Action Setup	49
Alarm In Event Action (Record) Setup Screen	49
Alarm In Event Action (Alarm Out) Setup Screen	50
Alarm In Event Action (Notify) Setup Screen	50
Motion Detector Event Action (Record) Setup Screen	51
Motion Detector Event Action (Alarm Out) Setup Screen	52
Motion Detector Event Action (Notify) Setup Screen	53
Text-In Event Action (Record) Setup Screen	53
Text-In Event Action (Alarm Out) Setup Screen	54
Text-In Event Action (Notify) Setup Screen	55
Video Loss Event Action (Record) Setup Screen	56
Video Loss Event Action (Alarm Out) Setup Screen	57
Video Loss Event Action (Notify) Setup Screen	57
Display Setup	58
OSD (On-Screen Display) Setup	58
Main Monitoring Setup Screen	59
Network Setup Screen	60
LAN Setup Screen	61
Modem Setup	65
DVRNS (DVR Name Service) Setup Screen	66
Callback Center Setup Screen	67
Password Setup Screen	70
Config (Configuration) Menu	71
Clip Copy	72
Load Default Setup	74
Load / Save Setup	75
Clear All Data	76
4 Operation	77
Turning on the Power	78
Live Monitoring	78
PTZ Mode	79
Digital Zoom Mode	81
Recording Video	81
Recording Audio	82
Playing Recorded Video	82
Playback Controls	83

Contents

Searching Video	85
Date/Time Search.	86
Calendar Search	86
Event Search	87
Text-In Search.	88
Appendix A USB Hard Disk Drive Preparation91
Preparing the USB-IDE Hard Disk Drive In Windows 2000	91
Preparing the USB-IDE Hard Disk Drive In Windows 98.	92
Appendix B Text-In Query Examples93
Text-In Query Example 1	94
Text-In Query Example 2	95
Appendix C Solutions97
Appendix D Connector Pinouts99
I/O Connector Pinouts	99
RS485 Connector Pinouts	100
Appendix E Map of Screens.	101
Appendix F Specifications	103
Index.	1

Contents

Figures

Figure 1-1	Typical DVR Installation	2
Figure 2-1	DVR Rear Panel	6
Figure 2-2	Video Input Connectors	6
Figure 2-3	Video Loop Through Connectors	6
Figure 2-4	Audio In and Out Connectors	7
Figure 2-5	CVBS (SVHS) VGA Switch.	8
Figure 2-6	Video Out Connectors	9
Figure 2-7	VGA Connector	9
Figure 2-8	Network Connector	10
Figure 2-9	RS232C Connector	10
Figure 2-10	Factory Reset Switch	11
Figure 2-11	Alarm Input Connector Strips	12
Figure 2-12	Alarm Output Connector Strips	13
Figure 2-13	RS485 Connector	13
Figure 2-14	USB Connector	14
Figure 2-15	Power Cord Connector	14
Figure 3-1	DVR Front Panel (4-Channel DVR Shown)	17
Figure 3-2	Admin Password Screen	21
Figure 3-3	Quick Setup Screen	21
Figure 3-4	Normal Setup Screen	23
Figure 3-5	System Information Screen	23
Figure 3-6	System Information Change Screen.	24
Figure 3-7	Virtual Keyboard	24
Figure 3-8	System Upgrade Screen.	25
Figure 3-9	Date/Time Screen	26
Figure 3-10	Holiday Setup Screen	27
Figure 3-11	Time Sync Screen	28
Figure 3-12	System Check (Config) Screen	29
Figure 3-13	System Check (Alarm Out / Notify) Screen	30
Figure 3-14	Storage Screen	31
Figure 3-15	S.M.A.R.T. Setup Screen	32
Figure 3-16	System Log Screen	33
Figure 3-17	Device Menu	34

Figures

Figure 3-18	Camera Setup Screen	34
Figure 3-19	PTZ Device List	35
Figure 3-20	Alarm In Screen	36
Figure 3-21	Motion Detector Screen	36
Figure 3-22	Motion Detection Zone Screen	37
Figure 3-23	Text-In Setup Screen	38
Figure 3-24	Text-In (Generic Text) Setup Screen	39
Figure 3-25	Text-In (EPSON-POS) Setup Screen	39
Figure 3-26	Alarm Out Screen	40
Figure 3-27	Alarm Out Schedule Screen	41
Figure 3-28	Audio Setup Screen	42
Figure 3-29	RS232/RS485 Screen	43
Figure 3-30	Record Mode Setup Screen	44
Figure 3-31	Time-Lapse Record Setup Screen.	46
Figure 3-32	Time-Lapse Recording Schedule Screen	47
Figure 3-33	Pre-Event Recording Setup Screen	48
Figure 3-34	Alarm In Event Action Screen	49
Figure 3-35	Alarm In Event Action (Alarm Out) Screen	50
Figure 3-36	Alarm In Event Action (Notify) Setup Screen	51
Figure 3-37	Motion Detector Event Action (Record) Setup Screen	51
Figure 3-38	Motion Detector Event Action (Alarm Out) Screen	52
Figure 3-39	Motion Detector Event Action (Notify) Screen.	53
Figure 3-40	Text-In Event Action (Record) Screen	54
Figure 3-41	Text-In Event Action (Alarm Out) Screen	55
Figure 3-42	Text-In Event Action (Notify) Screen.	55
Figure 3-43	Video Loss Event Action (Record) Screen	56
Figure 3-44	Video Loss Event Action (Alarm Out) Screen	57
Figure 3-45	Video Loss Event Action (Notify) Screen	57
Figure 3-46	OSD Setup Screen.	58
Figure 3-47	Main Monitoring Setup Screen	59
Figure 3-48	Network Setup Screen.	60
Figure 3-49	LAN Setup Screen	61
Figure 3-50	Port Number Setup Screen	62
Figure 3-51	LAN (DHCP) Setup Screen	64
Figure 3-52	LAN (ADSL) Setup Screen.	64
Figure 3-53	Modem Setup Screen	65
Figure 3-54	DVRNS Setup Screen	66
Figure 3-55	Callback Center Setup Screen	68
Figure 3-56	Callback Center (Modem) Setup Screen	69
Figure 3-57	Password Setup Screen	70
Figure 3-58	Config Menu	72
Figure 3-59	Clip Copy Screen	72
Figure 3-60	Disk Partition Selection Screen	73

Figures

Figure 3-61	Load / Save Setup Screen	75
Figure 4-1	DVR Front Panel	78
Figure 4-2	Live Monitoring (Text-In) Screen.	79
Figure 4-3	PTZ Menu Screen	80
Figure 4-4	PTZ Preset Screen	80
Figure 4-5	Preset View Screen	81
Figure 4-6	Playback (Text-In) Screen	83
Figure 4-7	Digital Zoom Screen	85
Figure 4-8	Search Menu.	85
Figure 4-9	Date/Time Search Screen	86
Figure 4-10	Calendar Search Screen.	86
Figure 4-11	Event Log Screen	87
Figure 4-12	Event Search (by Event) Screen.	87
Figure 4-13	Event Search (by Camera) Screen	88
Figure 4-14	Text-In Log Screen.	88
Figure 4-15	Text-In Search Screen	89
Figure B-1	Text-In Search Condition Example 1	94
Figure B-2	Text-In Search Condition Example 2	95
Figure E-1	Screen Map	101

Figures

Tables

Table 3-1	Front Panel LEDs and Controls.	18
Table 3-2	Motion Detection Zone Choices	37
Table 4-1	Playback Controls	83
Table F-1	Technical Specifications	103

Tables

About This Document

This document introduces the HRHD 410 4-channel Digital Video Recorder (DVR) and describes how to install, configure, and operate the DVR.

Overview of Contents

This document contains the following chapters and appendixes:

- *Chapter 1, Introduction*, introduces the HRHD 4-channel DVR, lists the features, and gives a functional overview of the components.
- *Chapter 2, Installation*, describes how to install the DVR and connect the system components.
- *Chapter 3, Configuration*, provides an overview of the front panel controls and LCD displays and provides instructions for configuring the DVR.
- *Chapter 4, Operation*, covers live monitoring, recording video and audio, playing recorded video, and searching for video.
- *Appendix A, USB Hard Disk Drive Preparation*, shows how to prepare the USB hard disk drive for computers using Microsoft® Windows® 2000/98 operating systems.
- *Appendix B, Text-In Query Examples*, provides examples of two typical text-in queries.
- *Appendix C, Solutions*, provides answers for common technical issues.
- *Appendix D, Connector Pinouts*, describes I/O and RS485 connector pinouts.
- *Appendix F, Specifications*, lists the DVR specifications.
- *Appendix E, Map of Screens*, provides a graphical illustration of the menu screens.

Important Safeguards

1. Read Instructions

All the safety and operating instructions should be read before the appliance is operated.

2. Retain Instructions

The safety and operating instructions should be retained for future reference.

3. Cleaning

Unplug this equipment from the wall outlet before cleaning it. Do not use liquid aerosol cleaners. Use a damp soft cloth for cleaning.

4. Attachments

Never add any attachments and/or equipment without the approval of the manufacturer as such additions may result in the risk of fire, electric shock, or other personal injury.

5. Water and/or Moisture

Do not use this equipment near water or in contact with water.

6. Accessories

Do not place this equipment on an unstable cart, stand, or table. The equipment may fall, causing serious injury to a child or adult, and serious damage to the equipment. Wall or shelf mounting should follow the manufacturer's instructions, and should use a mounting kit approved by the manufacturer.



This equipment and cart combination should be moved with care. Quick stops, excessive force, and uneven surfaces may cause the equipment and cart combination to overturn.

7. Power Sources

This equipment should be operated only from the type of power source indicated on the marking label. If you are not sure of the type of power, please consult your equipment dealer or local power company.

8. Power Cords

Operator or installer must remove power, BNC, alarm, and other connections before moving the equipment.

9. Lightning

For added protection for this equipment during a lightning storm, or when it is left unattended and unused for long periods of time, unplug it from the wall outlet and disconnect the antenna or cable system. This will prevent damage to the equipment due to lightning and power-line surges.

10. Overloading

Do not overload wall outlets and extension cords to avoid the risk of fire or electric shock.

11. Objects and Liquids

Never push objects of any kind through openings of this equipment as they may touch dangerous voltage points or short out parts that could result in a fire or electric shock. Never spill liquid of any kind on the equipment.

12. Servicing

Do not attempt to service this equipment yourself. Refer all servicing to qualified service personnel.

13. Damage Requiring Service

Unplug this equipment from the wall outlet and refer servicing to qualified service personnel under the following conditions:

- When the power-supply cord or the plug has been damaged
- If liquid is spilled or objects have fallen into the equipment
- If the equipment has been exposed to rain or water
- If the equipment does not operate normally by following the operating instructions, adjust only those controls that are covered by the operating instructions as an improper adjustment of other controls may result in damage and will often require extensive work by a qualified technician to restore the equipment to its normal operation.
- If the equipment has been dropped or the cabinet damaged
- When the equipment exhibits a distinct change in performance - this indicates a need for service.

14. Replacement Parts

When replacement parts are required, be sure the service technician has used replacement parts specified by the manufacturer or that have the same characteristics as the original part. Unauthorized substitutions may result in fire, electric shock, or other hazards.

15. Safety Check

Upon completion of any service or repairs to this equipment, ask the service technician to perform safety checks to determine that the equipment is in proper operating condition.

16. Field Installation

This installation should be made by a qualified service person and should conform to all local codes.

17. Correct Batteries

WARNING! Risk of explosion if battery is replaced by an incorrect type. Dispose of used batteries according to the instructions.

18. Operating Temperature

An operating temperature range is specified (see *Appendix F, Specifications*) so that the customer and installer may determine a suitable operating environment for the equipment.

19. Elevated Operating Ambient Temperature

If installed in a closed or multi-unit rack assembly, the operating ambient temperature of the rack environment may be greater than room ambient. Therefore, consideration should be given to installing the equipment in an environment compatible with the specified operating temperature range.

20. Reduced Air Flow

Installation of the equipment in the rack should be such that the amount of airflow required for safe operation of the equipment is not compromised.

21. Mechanical Loading

Mounting of the equipment in the rack should be such that a hazardous condition is not caused by uneven mechanical loading.

22. Circuit Overloading

Consideration should be given to connection of the equipment to supply circuit and the effect that overloading of circuits might have on over-current protection and supply wiring. Appropriate consideration of equipment nameplate ratings should be used when addressing this concern.

23. Reliable Earthing (Grounding)

Reliable grounding of rack mounted equipment should be maintained. Particular attention should be given to supply connections other than direct connections to the branch circuit (for example, use of power strips).

Introduction

Features

Your color digital video recorder (DVR) provides recording capabilities for 4 camera inputs. It provides exceptional picture quality in both live and playback modes, and offers the following features:

- 4 Composite Input Connectors
- Automatic detection of NTSC or PAL
- Compatibility with Color (NTSC or PAL) and B&W (CCIR and EIA-170) Video Sources
- Multiple search engines (Date/Time, Calendar, Event)
- Records up to 120 NTSC images per second (100 PAL ips)
- Loop-Through Video Connectors
- Continuous recording in Disk Overwrite Mode
- Continues recording while archiving, transmitting to remote site, and during playback
- User-friendly Graphical User Interface (GUI) menu system
- Various record modes (Time, Event, Pre-event, and Panic)
- Audio recording and playback
- Alarm connections include: Input, Output, and Reset Input
- Built-in alarm buzzer
- Live or recorded video access via Ethernet or modem

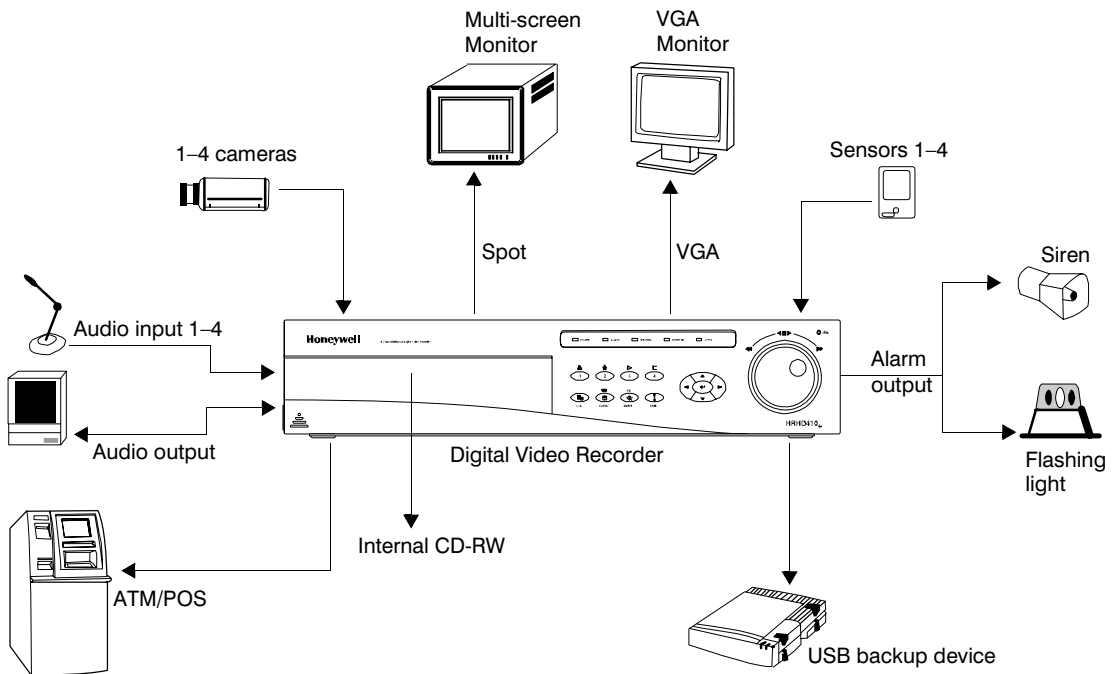
Figure 1-1 Typical DVR Installation

Technical Overview

Your DVR can replace both a time-lapse VCR and a multiplexer in a security installation. However, it has many features that make it much more powerful and easier to use than even the most advanced VCR.

The DVR converts analog NTSC or PAL video to digital images and records them on a hard disk drive. Using a hard disk drive allows you to access recorded video almost instantaneously; there is no need to rewind tape. The technology allows you to view recorded video while the DVR continues recording.

Digitally recorded video has several advantages over analog video recorded on tape. There is no need to adjust tracking. You can freeze frames, fast forward, fast reverse, slow forward, and slow reverse without image streaking or tearing. Digital video can be indexed by time or events, and you can instantly view video after selecting the time or event.

Your DVR can be set up for event or time-lapse recording. You can define times to record, and the schedule can change for different days of the week and user defined holidays.

Introduction

The DVR can be set up to alert you when the hard disk drive is full or it can be set up to record over the oldest video after the disk is full.

Your DVR uses a proprietary encryption scheme making it nearly impossible to alter video.

You can view live video, search for images, and control your DVR remotely by connecting via external modem or Ethernet. You can use the USB port to copy video clips to USB-IDE hard disk drives, USB CD-RW drives, or flash drives.

Installation

This chapter covers how to connect the DVR to peripheral equipment.

Package Contents

The package contains, in addition to this document:

- Digital Video Recorder
- Power cord
- User Guide (this document)
- Multilingual User Guide on HRHD CD-ROM
- RAS User Guide
- Multilingual RAS software and User Guide (RAS CD-ROM)
- DVRNS Server Software and User Guide on RAS CD-ROM
- Rack-mount Kit
- Assembly screws for adding hard disk drives

Required Installation Tools

No special tools are required to install the DVR. Refer to the installation manuals for the other items that make up part of your system to acquire an understanding of the tools required for the overall system installation.

Figure 2-1 DVR Rear Panel

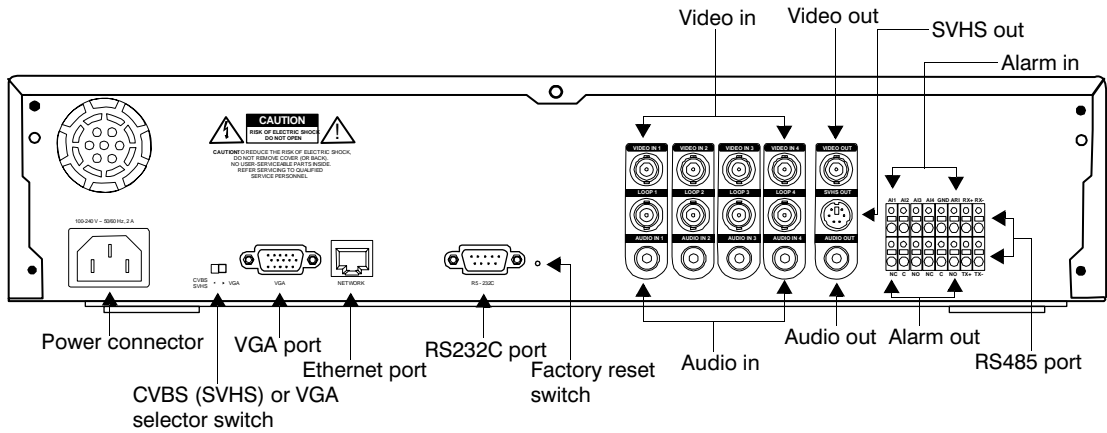

Connecting the Video Source

Figure 2-2 Video Input Connectors

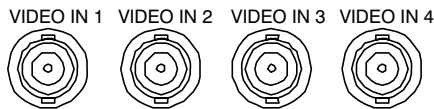

Connect the coaxial cables from the video sources to the BNC Video In connectors.

Connecting the Loop Through Video

Figure 2-3 Video Loop Through Connectors

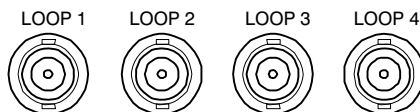

If you would like to connect your video source to another device, you can use the Loop BNC connectors.

Note The Loop BNC connectors are auto terminated. Do **not** connect a cable to the Loop BNC unless it is connected to another terminated device because it will cause poor quality video.

Connecting Audio

Note It is your responsibility to determine if local laws and regulations permit recording audio.

Figure 2-4 Audio In and Out Connectors



Your DVR can record audio.

1. Connect the audio source to Audio In.
2. Connect Audio Out to your amplifier.

Note The DVR does not have amplified audio output, so you need a speaker with an amplifier. The audio input must be from an amplified source.

Setting Unit for CVBS (SVHS) or VGA Output

Figure 2-5 CVBS (SVHS) VGA Switch

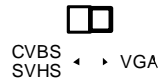

Set the switch to CVBS (SVHS) or VGA for monitor output. Select CVBS (SVHS) for a spot monitor or VGA for an RGB monitor.

Make sure you set the CVBS (SVHS) or VGA selector switch before turning on the DVR. You cannot change the setting while the unit is running.

Note The DVR may not support some LCD monitors. Also, some monitors do not support Multi Sync.

Note You cannot use the spot monitor and VGA outputs at the same time.

Connecting the Monitor

Connecting the Spot Monitor

Figure 2-6 Video Out Connectors

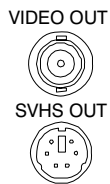

Connect the Spot Monitor to either the Video Out or SVHS Out connector.

Note For Spot Monitor output, set the CVBS (SVHS) VGA selector to **CVBS (SVHS)** (see *Figure 2-5*). If your monitor has an SVHS input, use it to give you better quality video display.

Note The Video Out (BNC) and the SVHS Out connectors may be connected to individual monitors for simultaneous operation.

Connecting the RGB Monitor

Figure 2-7 VGA Connector

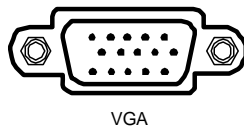

Use the VGA port for RGB Monitor output. Connect the RGB Monitor to the VGA connector. Connect an RGB cable with a DB15 (Male) connector which is usually less than 10 feet (3 m) to the DVR connector.

Note For RGB Monitor output, set the CVBS (SVHS) VGA selector switch to **VGA** (see [Figure 2-5](#)).

Connecting to the Network Port

Figure 2-8 Network Connector



The DVR can be networked using the 10/100Mb Ethernet connector. Connect a CAT5 cable with an RJ45 jack to the DVR connector. The DVR can be networked with a computer for remote monitoring, searching, configuration, and software upgrades. See [Chapter 3, Configuration](#) for configuring the Ethernet connections.

Connecting to the RS232C Port

Figure 2-9 RS232C Connector

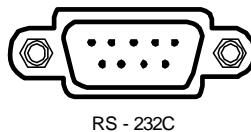

Use the RS232C port to connect an external modem for remote monitoring, configuration, and software upgrades, text input, and to connect a remote control keyboard. Use a modem cable with a DV9S (female) connector to connect to the DVR.

The DVR can be networked using the 10/100Mb Ethernet connector. Connect a CAT5 cable with an RJ45 jack to the DVR connector. The DVR can be networked with a computer for remote monitoring, searching, configuration, and software upgrades. See [Chapter 3, Configuration](#) for configuring the Ethernet connections.

Note The DVR is not supplied with a modem cable, and many modems are not supplied with cables. Make certain you have the correct cable when purchasing the modem.

Factory Reset

Figure 2-10 Factory Reset Switch

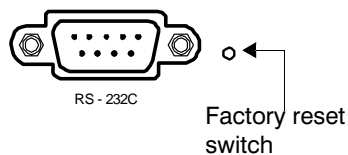

The DVR has a Factory Reset switch to the right of the RS232C connector. This switch will only be used on the rare occasions that you want to return all the settings to the original factory default settings.

Caution When using the Factory Reset, you will lose any settings you have made.

Caution If you wish to use the same DVR name registered on the DVRNS server after initializing the system using the factory reset, you need to contact the DVRNS server manager. Please record and save the help desk information before performing a factory reset.

To reset the unit, you need a straightened paper clip:

1. Turn the DVR off.
2. Turn it on again.
3. While the DVR is initializing, poke a straightened paper clip in the unlabeled hole to the right of the USB port.
4. Hold the switch until all the LEDs on the front panel are lit.

Note When the DVR successfully resets to factory defaults all the LEDs on the front panel flash three times.

5. Release the reset switch. All of the DVR settings are now at the original settings it had when it left the factory.

Connecting Alarms

Figure 2-11 Alarm Input Connector Strips

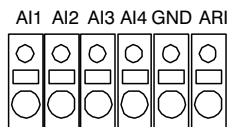

To make connections on the Alarm Connector Strip:

1. Press and hold the button.
2. Insert the wire in the hole below the button.
3. After releasing the button, tug gently on the wire to make certain it is connected.
4. To disconnect a wire, press and hold the button above the wire and pull out the wire.

AI 1 to 4 (Alarm In)

You can use external devices to signal the DVR to react to events. Mechanical or electrical switches can be wired to the AI (Alarm In) and GND (Ground) connectors. The threshold voltage is for NC (Normally Closed) is above 4.3V and should be stable at least 0.5 seconds to be detected. For NO (Normally Open), the threshold voltage is below 0.3V. See *Chapter 3, Configuration* for configuring alarm input.

GND (Ground)

Connect the ground side of the Alarm input to the GND connector.

ARI (Alarm Reset In)

An external signal to the Alarm Reset In (ARI) can be used to reset both the Alarm Out signal and the DVR internal buzzer. Mechanical or electrical switches can be wired to the ARI (Alarm In) and GND (Ground) connectors. The threshold voltage is below 0.3V and should be stable at least 0.5 seconds to be detected. Connect the wires to the ARI (Alarm Reset In) and GND (Ground) connectors.

Alarm Out

Figure 2-12 Alarm Output Connector Strips

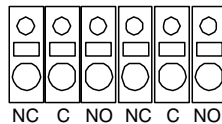

The DVR can activate external devices such as buzzers or lights. Mechanical or electrical switches can be wired to the NC (Normally Closed) and C (Common) connectors or NO (Normally Open) and C (Common) connectors. Permitted current is up to 0.5 A for 125 VAC and 1 A for 30 VDC. See *Chapter 3, Configuration* for configuring alarm output.

Connecting to the RS485 Port

Figure 2-13 RS485 Connector

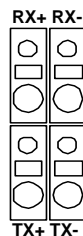

You can control the DVR remotely by an external device or control system, such as a control keyboard, using RS485 half-duplex serial communications signals. The RS485 connector can also be used to control PTZ (pan, tilt, zoom) cameras. Connect RX-/TX- and RX+/TX+ of the control system to the TX-/RX- and TX+/RX+ (respectively) of the DVR. See *Chapter 3, Configuration* and the PTZ camera or remote controller manufacturer's manual for configuring the RS485 connection.

Connecting to the USB Port

Figure 2-14 USB Connector

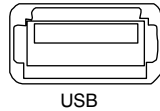

Use the USB port to connect external hard disk drives, CD-RW drives, or flash drives for archiving video.

1. Position the external hard disk drive close enough to the DVR so that you can make the cable connections, usually less than 6 feet (1.83 m).
2. Use the USB cable provided with the hard disk drive or CD-RW to connect it to the DVR.

See *Chapter 4, Operation* for archiving video to an external USB-IDE hard disk drive, USB CD-RW drive or USB flash drive.

You can also upgrade the software through the USB port.

Connecting the Power Cord

Figure 2-15 Power Cord Connector

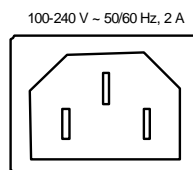

Connect the power cord of the adapter to the DVR and the other end to the wall outlet.

WARNING! Route power cords so they are not a tripping hazard. Make certain the power cord will not be pinched or abraded by furniture. Do not install power cords under rugs or carpet.

The power cord has a grounding pin. If your power outlet does not have a grounding pin receptacle, do not modify the plug.

Do not overload the circuit by plugging too many devices into one circuit.

Your DVR is now ready to operate. See *Chapter 3, Configuration* and *Chapter 4, Operation*.

Configuration

This chapter covers the following topics:

- Front panel controls and LEDs
- Initial unit setup
- Configuring input devices
- Configuring recording settings
- Configuring event action
- Configuring on-screen display
- Configuring network setup
- Configuring password setup

Note Ensure that your DVR is completely installed before proceeding. See *Chapter 2, Installation*.

Front Panel Controls

Figure 3-1 DVR Front Panel (4-Channel DVR Shown)

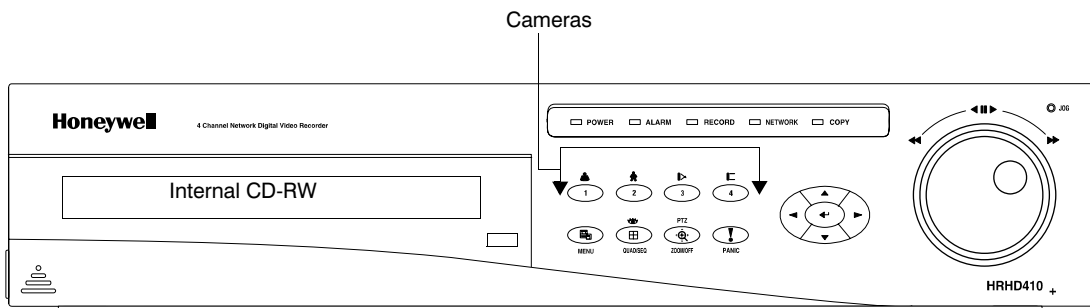

Many of the buttons have multiple functions. *Table 3-1* describes each button and control. Take a few minutes to review the descriptions. You will use these to initially set up your DVR and for daily operations.

Note There is no separate Alarm button. Pressing any key on the front panel resets alarm output, including the internal buzzer when the alarm is activated. However, when you are in the menu or PTZ mode, you must exit the menu or PTZ mode first to reset the alarm output.

Table 3-1 Front Panel LEDs and Controls



Front panel	Function
LEDs	
POWER	The POWER LED is lit when the DVR is On.
ALARM	The ALARM LED is lit when alarm output or internal buzzer is activated.
REC	The REC LED is lit when the DVR is recording. When the DVR is in Panic recording mode, the REC LED flickers.
NETWORK	The NETWORK LED is lit when the unit is networked, either via Ethernet or modem.
COPY	The COPY LED is lit when data is being copied using the internal CD-RW or the USB port.
BUTTONS Press the button to ...	
Camera buttons (1-4)	<ul style="list-style-type: none"> • Cause the selected camera to display full screen. • Enter passwords. • Function in PTZ mode: <ul style="list-style-type: none"> Press CAMERA 1 to zoom in in PTZ mode. Press CAMERA 2 to zoom out in PTZ mode. Press CAMERA 3 to control near focus of the PTZ camera in PTZ mode. Press CAMERA 4 to control far focus of the PTZ camera in PTZ mode.
MENU 	<ul style="list-style-type: none"> • Enter the Main Menu. You must enter the administrator password to access the Main Menu. Pressing MENU also closes the current menu or setup dialog box. • Displays the Search menu in Playback mode. • Loads the PTZ menu in PTZ mode.
QUAD/SEQ 	<ul style="list-style-type: none"> • Toggle between quad (2x2) display mode and sequence mode. • Loads a Preset view in the PTZ mode.

Table 3-1 Front Panel LEDs and Controls (cont'd)





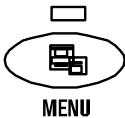







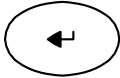

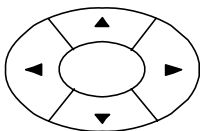

Front panel	Function
<p>PTZ buttons</p> 	<ul style="list-style-type: none"> • Opens a Pan/Tilt/Zoom screen that allows you to control properly configured PTZ cameras. • In PTZ mode, pressing PTZ enters the Digital Zoom mode. Press PTZ again in Digital Zoom mode to return to Live Monitoring mode. When a PTZ device is not installed, press PTZ to enter the Digital Zoom mode directly. • Press PTZ in Playback mode to enter the Digital Zoom Playback mode. <p>Note When the DVR is in the PTZ mode, a white line displays around the image.</p> <p>Note In Digital Zoom mode and Digital Zoom Playback mode, a bright small box is laid over the image. The box indicates the spot to be enlarged.</p>
<p>PANIC</p> 	<p>Start panic recording so that the DVR records video regardless of time-lapse or event recording schedules. Press PANIC again to stop the panic recording.</p> <p>Note When the DVR is recording video, a red dot appears on the screen. When the DVR is in panic recording mode, a white  displays in the red dot and the REC LED on the front panel flickers.</p>
<p>ENTER/PAUSE</p> 	<ul style="list-style-type: none"> • Select a highlighted item or complete an entry that you have made during system setup. • Press ENTER/PAUSE in Live Monitoring mode to freeze the current live screen. The screen displays *. Press ENTER/PAUSE again to return to Live Monitoring mode. • Press ENTER/PAUSE in Playback mode to pause the video. The screen displays . Press ENTER/PAUSE again in pause mode to go to Live Monitoring mode. • In Digital Zoom mode, press ENTER/PAUSE to enlarge a specific area of the screen. The enlarged screen displays .
<p>Up, Down, Left, Right Arrows</p> 	<p>Use to:</p> <ul style="list-style-type: none"> • Navigate through menus and GUI • Control Pan and Tilt when in PTZ mode <p>In playback mode, the Up Arrow button selects the next image and the Down Arrow button selects the previous image.</p> <p>Press the Left Arrow to play video backwards at high speed. Press the button again to toggle the playback speed from , , and . The screen displays , , and  respectively.</p> <p>Press the Right Arrow button to play video forward at high speed. Press the button again to toggle the playback speed from , , and . The screen displays , , and  respectively.</p> <p>Entering Playback mode from Live Monitoring mode can be user password protected.</p>

Table 3-1 Front Panel LEDs and Controls (cont'd)

Front panel	Function
<p>Shuttle Ring</p> 	<p>The Shuttle Ring only functions in Playback mode. The Shuttle Ring is spring loaded. When released, the video pauses and the ring returns to the center position. Turn the ring clockwise to play video forward. Turn the ring counterclockwise to play video backward.</p> <p>Playback speed varies with the amount the ring is turned. The playback speeds are ◀x0.5, ◀◀, ◀◀◀, ◀◀◀◀, ▶x0.5, ▶, ▶▶, ▶▶▶, and ▶▶▶▶.</p>
<p>Jog Dial</p> 	<p>The Jog Dial only functions when playback video has been paused. Turn the jog dial clockwise to play video forward image-by-image. Turn the jog dial counterclockwise to play video backward image-by-image.</p> <p>You can also use the Jog Dial to change numerical values such as IP addresses, date/time, and page during the system setup.</p>

Turning on the Power

Connect the power cord to the DVR to turn on the DVR. The DVR takes approximately 60 seconds to initialize.

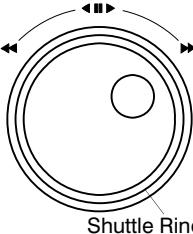
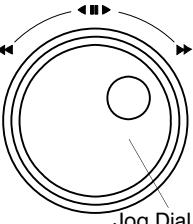
Initial Unit Setup

Before using your DVR for the first time, you should establish the initial settings. This includes items such as time and date, display language, camera, audio, remote control, record mode, network and password. Your DVR can be set up using various screens and dialog boxes.

1. Press **MENU** to enter the setup screens. The Admin Password screen displays.

Figure 3-2 Admin Password Screen



2. Enter the password by pressing the appropriate combination of Camera buttons and then **ENTER** (↵). The factory default password is 4321. There are two Setup screens: Quick Setup and Normal Setup. The factory default is the Quick Setup screen.

Quick Setup Screen

Figure 3-3 Quick Setup Screen

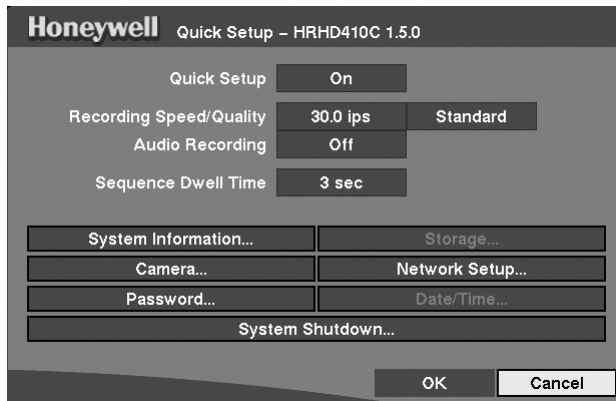

Use the Quick Setup screen to set up the most commonly used features of your DVR. Use the Arrow buttons to move through the options. Pressing ↵ lets you make your selections.

1. Highlight the box beside **Quick Setup** and then press ↵ to toggle between On and Off. If you select **Off**, you will use the Normal Setup screen to change the DVR settings.
2. Highlight the **Recording Speed/Quality** box and select recording speeds from as few as 0.5 ips to as fast as 30 ips (25 for PAL).
3. Highlight the second box beside **Recording Speed/Quality** and select recording speeds from as few as 0.5 ips to as fast as 30 ips (25 ips for PAL).
4. Highlight the box beside **Audio Recording** and select either **On** or **Off**.

Note It is your responsibility to determine if local laws and regulations permit recording audio.

5. Highlight the box beside **Sequence Dwell Time** and select from **3** to **60** seconds for the camera sequence dwell time.
6. Selecting **System Information...** enters a screen that allows you to set the site name, set the language and view various system operational parameters.
7. Selecting **Storage...** enters a screen where you can check the storage status.
8. Selecting **Camera...** enters a screen where you can set up camera operation.
9. Selecting **Network Setup...** enters a screen where you can set up network operational settings.
10. Selecting **Password...** enters a screen where you will be able to change passwords.
11. Selecting **Date/Time...** enters a screen where you will be able to set the DVR time and date.
12. Selecting **System Shutdown...** shuts the DVR down. When shutting down the DVR, you need to confirm that you want to shut down the unit and you will be asked for an administrator password.

Note The Quick Setup mode releases automatically when a user changes the DVR settings remotely using the RAS (Remote Administration System) program.

Normal Setup Screen

Figure 3-4 Normal Setup Screen

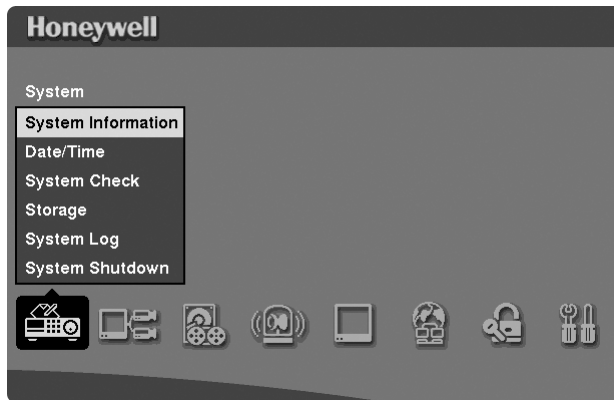

Press **MENU** to enter the Normal Setup screen. If the Quick Setup screen displays, turn it off as described above. The Normal Setup screen gives you access to all the DVR setup screens.

System Information

Use the System Information screen to name the Site Description (name), assign a unit ID number, select the language to use, and upgrade the software.

Highlight **System Information (MENU ► System ► System Information)** and press **↵**. The System Information screen displays.

Figure 3-5 System Information Screen

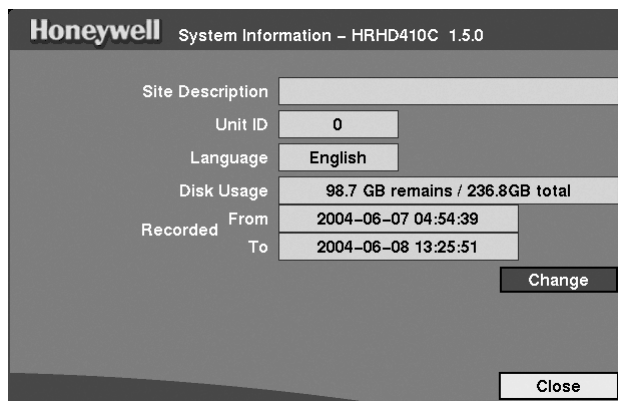

1. Highlight **Change** and press **↵**. The System Information Change screen displays.

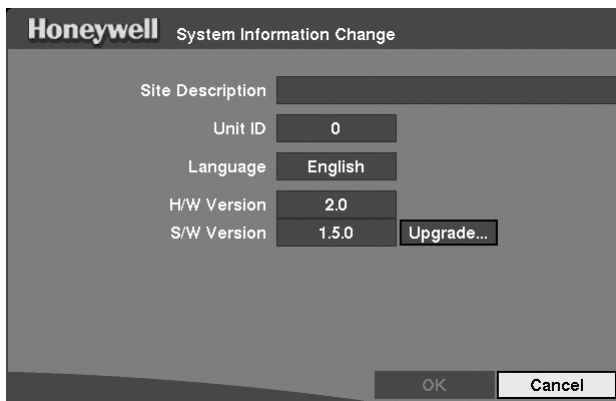

Figure 3-6 System Information Change Screen



2. Highlight the box beside **Site Description** and press \leftarrow . A virtual keyboard displays.

Figure 3-7 Virtual Keyboard



3. Use the Arrow keys to highlight the first character you want in the **Site Title** field and then press \leftarrow . That character appears in the title bar and the cursor moves to the next position. You can use up to 20 characters including spaces in your title.
 Press  to toggle between the upper and lower case keyboards.
 Press  to backspace to the previous character.
 Press  to delete entered characters.
 After you have entered your title, highlight **Close** and then press \leftarrow .
4. Highlight the box beside **Unit ID** and then press \leftarrow .
 Change the number by highlighting it and using the Up and Down Arrow buttons to increase and decrease the number. The Unit ID number is used to identify the unit when it is networked with other DVRs.

Note You cannot use the same number for two or more DVRs that are within the same network.

5. Highlight the box beside **Language** and press \leftarrow . A drop-down list displays the available languages (English, French, Spanish, Italian, and German). Highlight the desired language and then press \leftarrow .

6. The box beside **H/W Version** and **S/W Version** displays current hardware and software versions of the DVR.

Note You can upgrade the software only in the System Information Change screen.

Only the System Administrator can upgrade the software.

You cannot upgrade the software during clip copy.

To upgrade the software:

- a. Connect the USB device containing the upgrade package file to the DVR. Highlight **Upgrade...** and press \leftarrow . The System Upgrade screen displays showing the upgrade package file name.

Note If no hard disk drives are installed in the DVR, the Upgrade... button will be disabled.

Note If the file system on the USB -IDE hard disk drive or USB flash drive is not FAT16 or FAT32 format, format the device using FAT16 or FAT32 format.

Figure 3-8 System Upgrade Screen

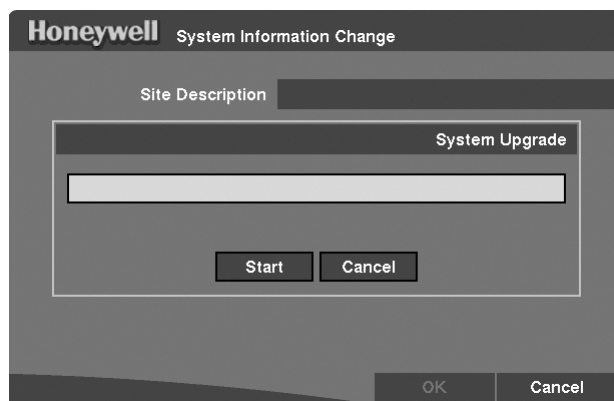

- b. Select **Start** and then enter the Admin password to start the upgrade.
- c. The system restarts automatically after the upgrade is complete. The software starts running after restarting the unit.

Note Only the system administrator can upgrade the software.
You cannot upgrade the software during clip copy.

7. You can save your changes by highlighting **OK** and pressing \leftarrow . Selecting **Cancel** exits the screen without saving the changes.

Date/Time Setup

Highlight **Date/Time** in the Main Menu (**MENU** \blacktriangleright **System** \blacktriangleright **Date/Time**) and then press \leftarrow . The Date/Time setup screen displays.

Figure 3-9 Date/Time Screen

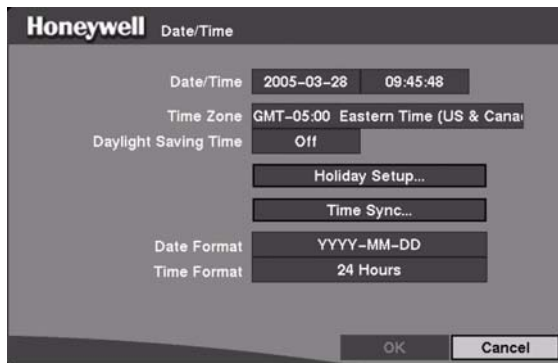

Caution If you set a date and time that is older than some of your recorded images, any images with dates and times later than the new setting will be deleted.

1. Highlight the first box beside **Date/Time** and then press \leftarrow . The individual sections of the date highlight.
Use the Up and Down Arrow buttons or the Jog Dial to change the number. Use the Left and Right Arrow buttons to move between month, day and year.
After you have the correct date, press \leftarrow .
2. Highlight the second box beside **Date/Time** and press \leftarrow . The individual sections of the time will highlight.
Use the Up and Down Arrow buttons or the Jog Dial to change the number.
Use the Left and Right Arrow buttons to move between hour, minutes and seconds.
After you have the correct time, press \leftarrow .

Note The clock will not start running until you have restarted the unit, so you may wish to set the time last.

3. Highlight the box beside **Time Zone** and press \leftarrow . Select the time zone you are in from the list and press \leftarrow .
4. Highlight the box beside **Daylight Saving Time** and press \leftarrow . Pressing \leftarrow toggles between **On** and **Off**.
5. Highlight the **Holiday Setup...** box and press \leftarrow . You can set up holidays by highlighting **Add:** and pressing \leftarrow . The current date displays.
6. Highlight the month and day and change them by using the Up and Down Arrow buttons. Press \leftarrow to add the date. Dates can be deleted by highlighting the X beside the date and pressing \leftarrow .

Note Holidays that do not fall on the same date each year should be updated after the current year's holiday has passed.

Figure 3-10 Holiday Setup Screen

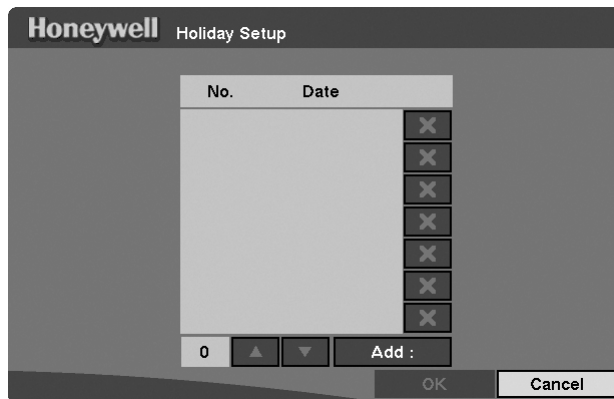

To save your changes, highlight **OK** and then press \leftarrow . Select **Cancel** to exit the screen without saving the changes.

Highlight the **Time Sync...** box on the Date/Time Setup screen, and \leftarrow . You can synchronize the DVR time with any standard time servers that are available in most time zones and countries, or synchronize time between two different DVRs.

Figure 3-11 Time Sync Screen

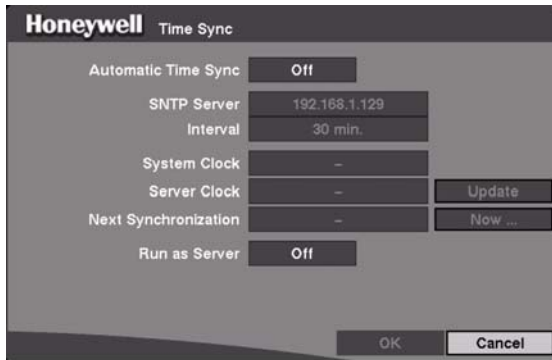

Highlight the box beside **Automatic Time Sync** and then press \leftarrow to toggle between **On** and **Off**.

Highlight the box beside **SNTP Server** and then press \leftarrow . Change the numbers by highlighting them and using the Up and Down arrows to increase or decrease the number value.

Highlight the box beside **Interval** and then press \leftarrow . Set the time interval for synchronization from **30** to **300** minutes.

The box beside **System Clock** displays the DVR time setting.

The box beside **Server Clock** displays the time setting of the time server. Highlighting the **Update** button and then pressing \leftarrow updates the server clock.

Note The Server Clock displays "-" when the DVR cannot load the time information from the time server.

The box beside **Next Synchronization** displays the time when the next synchronization is scheduled. If you want to synchronize the time instantly, highlight the **Now...** button and then press \leftarrow .

Caution When selecting **Now...**, any video with a later time and date will be lost if the time and date of a time server is earlier than the last recorded image of the DVR.

Note When the time difference between the DVR and the time server is more than one minutes, the DVR might not synchronize the time to prevent any unexpected loss of recorded video data. If you want to synchronize the time manually, select Now... .

Highlight the **Run as Server** box and then press \leftarrow to toggle between **On** and **Off**. When it is **On**, the DVR you are setting up runs as a time server.

To save your changes, highlight **OK** and then press \leftarrow . Select **Cancel** to exit the screen without saving the changes.

Highlight the box beside **Date Format** and press \leftarrow . A list of date formats displays. Highlight the format you wish to use and then press \leftarrow . The choices are:

- MM-DD-YYYY
- DD-MM-YYYY
- YYYY-MM-DD
- MM/DD/YYYY
- DD/MM/YYYY
- YYYY/MM/DD

To change the time format, highlight the box beside **Time Format** and then press \leftarrow . The DVR toggles between **12 Hours** (AM/PM) and **24 Hours** (military time).

To save your changes, highlight **OK** and then press \leftarrow . Select **Cancel** to exit the screen without saving the changes.

System Check Screen

Use the System Check screen to check the status (fault condition) of the DVR. Highlight **System Check** in the Main Menu (**MENU** \blacktriangleright **System** \blacktriangleright **System Check**) and then press \leftarrow . The System Check setup screen displays.

Figure 3-12 System Check (Config) Screen

Honeywell System Check			
Config		Alarm Out / Notify	
Check Point	On/Off	Interval	Status
System	Off	1 Hour	
Record	Off	1 Hour	
Alarm In 1	Off	1 Hour	
Alarm In 2	Off	1 Hour	
Alarm In 3	Off	1 Hour	
Alarm In 4	Off	1 Hour	

OK Cancel

1. Highlight the box under the **On/Off** heading and then press \leftarrow . This toggles between **On** and **Off**.

When it is **On**, the DVR reports a fault condition if it does not detect any recording or if there is no alarm during the designated time.

2. Highlight the box under the **Interval** heading and then press \leftarrow . A slide bar displays allowing you to set the check interval from **1 Hour** to **30 Days** by using the Left and Right Arrow buttons.

3. The Status field displays the fault conditions.

Good means that there was recording or an alarm occurred during the designated time.

Bad indicates that there was no recording or no alarm occurred during the designated time.

4. Highlight the **Alarm Out / Notify** tab and the **System Check - Alarm Out / Notify** screen displays.

Figure 3-13 System Check (Alarm Out / Notify) Screen

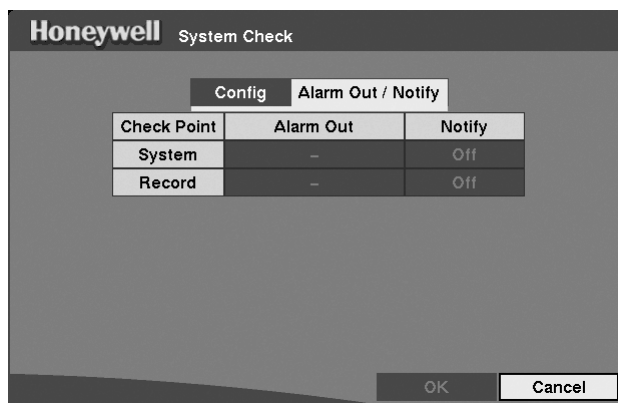

5. Highlight the box under the **Alarm Out** heading and press \leftarrow . A drop menu displays available alarm outputs for the recording problem.
6. Highlight the desired alarm output from the external alarm out terminal or internal buzzer, and press \leftarrow .

Note Alarm Out cannot be set to Check Point **System**.

7. Highlight the box under **Notify** and press \leftarrow . This toggles between **On** and **Off**. When it is **On**, the DVR notifies the remote site of its **System (Good)** and **Record (Bad)**.

Storage Screen

Highlight **Storage** in the Main Menu (**MENU** ► **System** ► **Storage**) and then press **↵**. The Storage setup screen displays.

Figure 3-14 Storage Screen

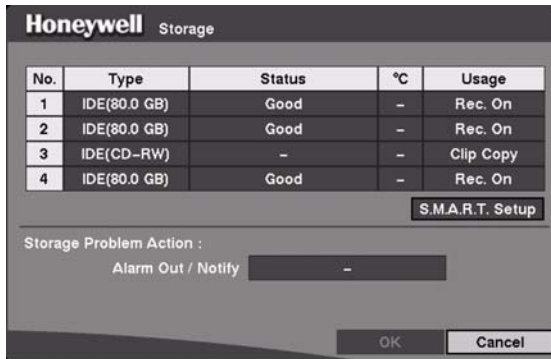

The **Type** field displays the type and capacity of storage devices.

The **Status** field displays the device status or fault conditions. Options are:

- Good**
- Disk Bad**
- S.M.A.R.T.**
- Alert**
- High Temperature**
- Not installed**

Note If the DVR senses S.M.A.R.T (Self-Monitoring, Analysis and Reporting Technology), Alert, or High Temperature, the S.M.A.R.T. Monitoring Information screen displays. When this happens, we recommend that you replace the hard disk drive, usually within 24 hours.

The S.M.A.R.T. Monitoring Information screen only displays in Live Monitoring mode.

The **°C** field displays the temperature of the storage device.

The **Usage** field displays the device usage. You can set the DVR to react to storage problems by activating an internal buzzer or external alarms, display a warning message and/or notifying a PC running RAS (Remote Administration System).

1. Highlight the box beside the **Storage Problem Action: Alarm Out/Notify** and then press **↵**. You can select **Beep**, the **External Alarm Out Terminal** you want to associate with the storage problem event, and/or **Notify**.

2. Highlight **S.M.A.R.T. Setup...** and then press **↵**. The S.M.A.R.T. Setup screen displays.

Note If no hard disk drives are installed in the DVR, the S.M.A.R.T. Setup... button is disabled.

Figure 3-15 S.M.A.R.T. Setup Screen

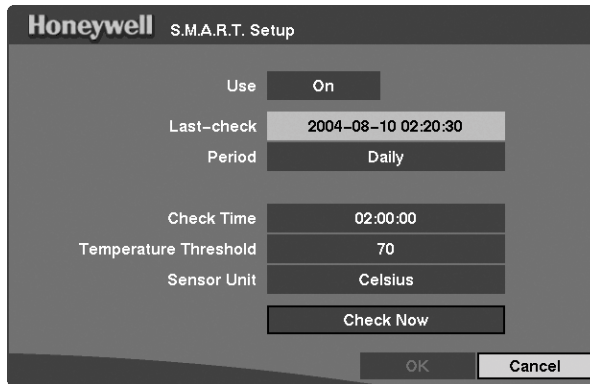

Your DVR shows the conditions of hard disk drives when the installed IDE hard disk drives support S.M.A.R.T. Monitoring program.

- a. Highlight the box beside **Use**. Press **↵** to toggle between **On** and **Off**.
- b. The **Last-check** field shows the date and time information of the last storage check.
- c. Highlight the box beside **Period** and select from **Daily**, **Weekly**, or **Monthly** for the checking period.

Note When you select **Weekly** or **Monthly**, the **Day of Week** or **Day of Month** fields will be activated under the Period field. Select the check day or check date.

- d. Highlight the box beside **Check Time** and adjust the numbers as desired using the Arrow buttons.
- e. Highlight the box beside **Temperature Threshold** and adjust the numbers as desired using the Arrow buttons.
- f. Highlight the box beside **Sensor Unit** and select from **Celsius** or **Fahrenheit**.
- g. If you want to check the storage status instantly, highlight **Check Now**, and then press **↵**.
- h. You can save your changes by highlighting **OK** and then pressing **↵**. Selecting **Cancel** exits the screen without saving the changes.

System Log Screen

Highlight **System Log** in the Main Menu (**MENU** ► **System** ► **System Log**) and then press **↵**. The System Log screen displays.

Figure 3-16 System Log Screen

No.	Event	Date/Time
1283	Setup Begin (Local)	2004-05-06 10:27:14
1282	System Started	2004-05-06 10:27:12
1281	Shutdown	2004-05-06 10:27:02
1280	System Time Changed	2004-05-06 10:27:00
1279	Setup Begin (Local)	2004-05-06 10:26:08
1278	System Started	2004-05-06 10:26:02
1277	System Reboot	2004-05-06 10:26:02

The System Log screen displays a record of various events logged by the DVR. The list shows the dates and times the system was turned ON and OFF, the system was restarted, recording was started or stopped, playback was started or stopped, setup changes were made, and data banks were cleared.

The events are listed from the most recent to the oldest. To scroll through the list a page at a time, select the Up and Down Arrow buttons on the screen and then press **↵**. To go directly to an event number, highlight the event number box (left of the UP Arrow), press **↵**, use the Arrow buttons to change the number, and then press **↵**.

System Shutdown

Highlight **System Shutdown** in the Main Menu (**MENU** ► **System** ► **System Shutdown**) and then press **↵**. This shuts the DVR down. When shutting down the DVR, you need to confirm that you want to shut down the unit, and you will be asked for an administrator password.

Configuring Input Devices

Use the Device menu (**MENU** ► **Device**) to configure the video, audio, and remote control devices connected to the DVR.

Figure 3-17 Device Menu



Camera Setup Screen

Use the Camera Setup screen to turn each camera on or off and to hide the video associated with that camera number. Highlight **Camera** in the Device menu (**MENU** ► **Device** ► **Camera**) and then press **↵**. The Camera setup screen displays.

Figure 3-18 Camera Setup Screen

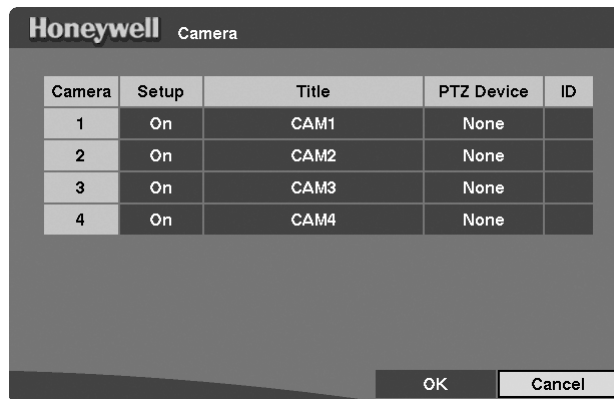

- To hide the video associated with a camera number, highlight the camera **Setup** heading and then press \leftarrow . You can select the **Setup** field for one specific camera or select the **Setup** heading to change the settings for all four cameras at once. Select from the following options in the drop-down list:

On, Off, Covert 1, Covert 2

Note When you select **Covert 1**, the DVR displays the camera title and status icons on the covert video. When you select **Covert 2**, the DVR displays only camera title on the covert video.

- To assign titles to each camera, highlight the camera title under the **Title** heading and then press \leftarrow . A virtual keyboard (see *Figure 3-7*) allows you to enter camera names.
- Selecting the **PTZ Device** box causes a list of controllable cameras to display. Select your camera from the list and then press \leftarrow . You must connect the camera to the RS485 terminal on the back of the DVR following the camera manufacturer's instructions.

Figure 3-19 PTZ Device List

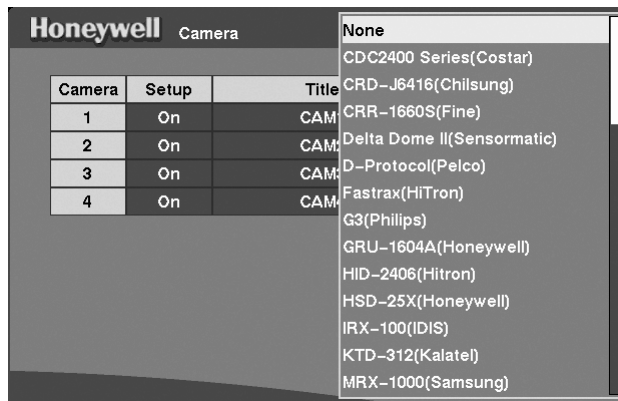

- To assign IDs to each camera, highlight the **ID** heading and then press \leftarrow . To change the number, highlight it and use the Up and Down Arrow buttons to increase and decrease the numbers. The camera ID number can be set from **0** to **256**.

Alarm In Setup Screen

The alarm terminal strip on the back of the DVR has inputs associated with each alarm. Use the Alarm In screen to configure each alarm input. Highlight **Alarm In** in the Device menu (**MENU** \blacktriangleright **Device** \blacktriangleright **Alarm-In**) and then press \leftarrow . The Alarm In setup screen displays.

Figure 3-20 Alarm In Screen

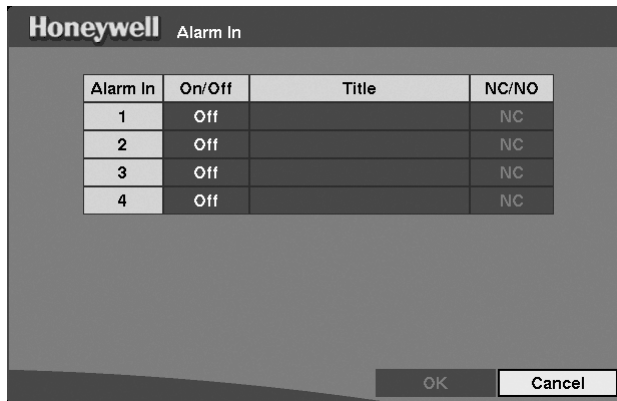

You can turn each input **On** (via Alarm I/O or Camera Alarm) or **Off**. Each input can be given a title, and the inputs can be set as **NO** (normally open) or **NC** (normally closed) independently.

Motion Detector

Your DVR has a built-in video motion detector. Use the Motion Detector screen to turn video motion detection On or Off for each camera and to define the area of the image where you want to detect motion.

Highlight **Motion Detector** in the Device menu (**MENU** ► **Device** ► **Motion Detector**) and then press **↵**. The Motion Detector setup screen displays.

Figure 3-21 Motion Detector Screen

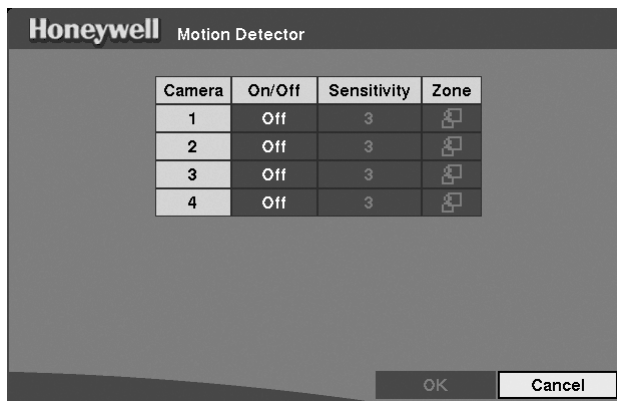

To adjust the DVR sensitivity to motion, highlight the box under the **Sensitivity** heading. There are five settings from **1** to **5**—**1** is the least sensitive and **5** is the most sensitive.

You can define the area of the image where you want to detect motion; for example, a doorway. Highlight the icon under the **Zone** heading, and then press **↵**. The Motion Detection Zone screen displays.

Figure 3-22 Motion Detection Zone Screen

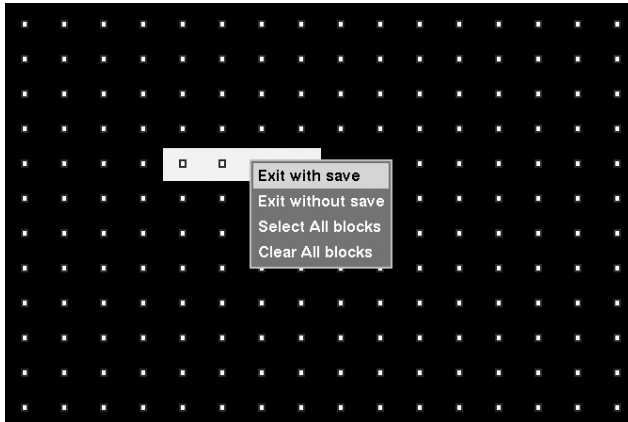

The Motion Detection Zone screen is laid over the video for the selected camera. You can set up motion detection zones by selecting or clearing blocks.

Note You can activate or deactivate four cells at a time using the \leftarrow button. After four cells are highlighted, if you hold the \leftarrow button down until the color of the highlighted cell changes from blue to yellow, you can select individual cells by using the camera buttons.

Press **Menu** on the front panel to open the Motion Detection Zone menu. The menu choices are described as follows:

Table 3-2 Motion Detection Zone Choices

Menu choice	Description
Exit with save	Closes the menu after saving the changes.
Exit without save	Closes the menu without saving the changes.
Select All Blocks	Activates all blocks to detect motion.
Clear All Blocks	Deactivates all blocks so that they will not detect motion.

Text In Setup Screen

Use the Text-In Setup screen to set the DVR to display the text-in information. Highlight **Text-In** in the Device menu (**MENU** \blacktriangleright **Device** \blacktriangleright **Text-In**) and then press \leftarrow . The Text-In setup screen displays.

Figure 3-23 Text-In Setup Screen

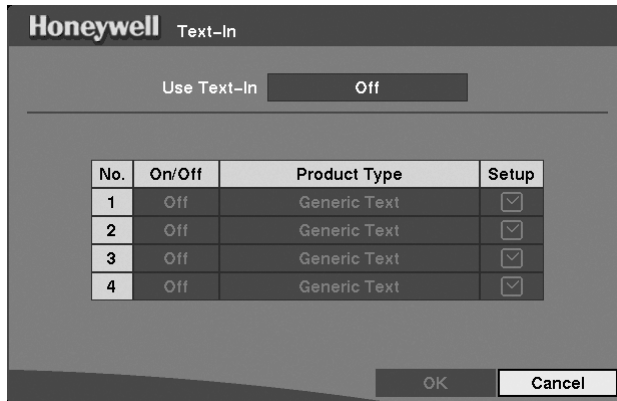

Note If networking is configured by the external modem, the text-in cannot be set up. Set the DVR for LAN connections and set up text-in for the RS232C port.

Note Text-in data will not be recorded during clip copy.

1. To set the DVR to display the text-in information, highlight the box beside **Use Text-In** and press \leftarrow to toggle between **On** and **Off**.
2. Highlight the box under the **Product Type** heading and then press \leftarrow . Select your device from the list.

Note Generic Text and EPSON-POS devices are currently supported.

Note The following description is for Generic Text and EPSON-POS devices. The screen changes for different types of text input devices and there will be different parameter boxes for you to enter information.

Figure 3-24 Text-In (Generic Text) Setup Screen

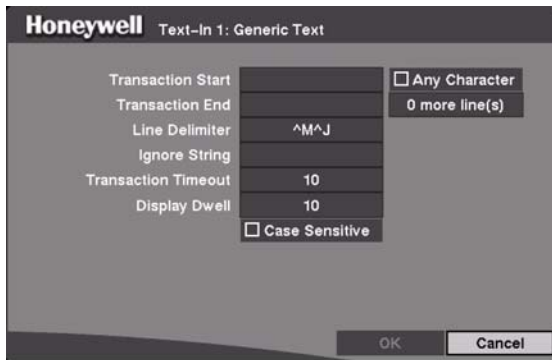
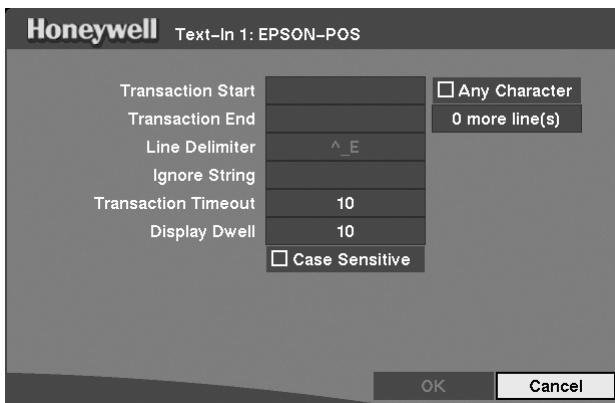

Figure 3-25 Text-In (EPSON-POS) Setup Screen



3. Highlight the box beside **Transaction Start** and then press \leftarrow . A virtual keyboard (see [Figure 3-7](#)) displays. Enter the transaction start string. Refer to the device manufacturer's documentation for the text string that the device first sends when a transaction starts.
4. If you want the DVR to react to any character sent from the text input device, turn on **Any Character**. To do this, highlight **Any Character** and then press \leftarrow to toggle between **On** and **Off**.

Note If Any Character is turned **On**, you will not be able to enter any text in the Start String box.

5. Highlight the box beside **Transaction End** and then press \leftarrow to display the virtual keyboard. Enter the transaction end string. Refer to the device manufacturer's documentation for the text string that the device sends when a transaction ends.
6. Highlight the **more line(s)** \leftarrow box and then press \leftarrow . Select the number of additional lines of text that you want the DVR to record, between **0** and **10**.
7. Highlight the box beside **Keyword2** and press \leftarrow to display the virtual keyboard. Enter the second key word for transaction field detection.

8. Highlight the box beside **Line Delimiter** and press \leftarrow . In the virtual keyboard, enter the character(s) that the device uses to indicate the end of a line. Control characters can be created using \wedge and a capital letter (for example, $\wedge J$ for NL [New Line], $\wedge M$ for CR [Carriage Return]). Refer to the device manufacturer's documentation for Line Delimiter character(s).
9. Highlight the box beside **Ignore String** and then press \leftarrow . Use the virtual keyboard to enter any strings of text that you want the DVR to ignore. Refer to the device manufacturer's documentation for text strings that the device sends during transactions, so you will know which ones you do not want recorded.

Note When setting up the EPSON-POS device, the user cannot change **Line Delimiter** and **Ignore String** parameters.

10. Highlight the box beside **Transaction Timeout**, and set the length of time to wait for the new text string. The DVR will consider a transaction ended if there is no text string during timeout dwell time after the last text input string. You can adjust the timeout dwell from **0** to **300** seconds.
11. Highlight the box beside **Display Dwell**, and set the length of time you would like to display text-in data. You can adjust the display dwell time from **1** to **300** seconds.
12. Highlight the **Case Sensitive** box and then press the \leftarrow to toggle between **On** and **Off**. Refer to the device manufacturer's documentation to determine if the text strings are Case Sensitive. If the device distinguishes between upper and lower case letters, make certain the **Case Sensitive** box is turned **On**.

Alarm Out Setup Screen

Use the Alarm Out setup screen to establish a schedule for each alarm output from the DVR. Highlight **Alarm Out** from the Device menu (**MENU** \blacktriangleright **Device** \blacktriangleright **Alarm-Out**) and then press \leftarrow . The Alarm Out setup screen displays.

Figure 3-26 Alarm Out Screen

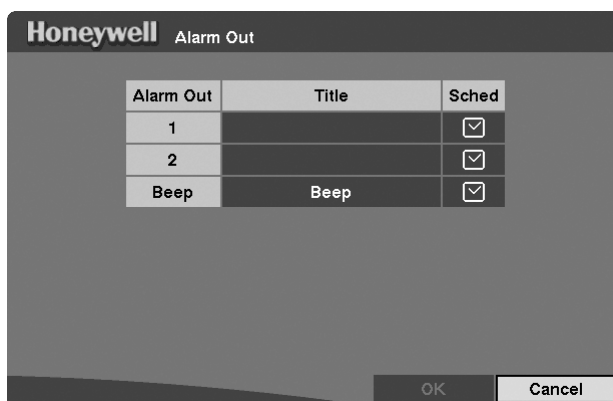

To give each alarm output its own title, highlight the box under the **Title** heading and then press \leftarrow . A virtual keyboard displays (see *Figure 3-7*) allowing you to enter the title.

Highlight the **Sched** field and press \leftarrow to open a schedule screen. You can schedule alarm output in 30-minute increments from 0:00 to 24:00.

Figure 3-27 Alarm Out Schedule Screen

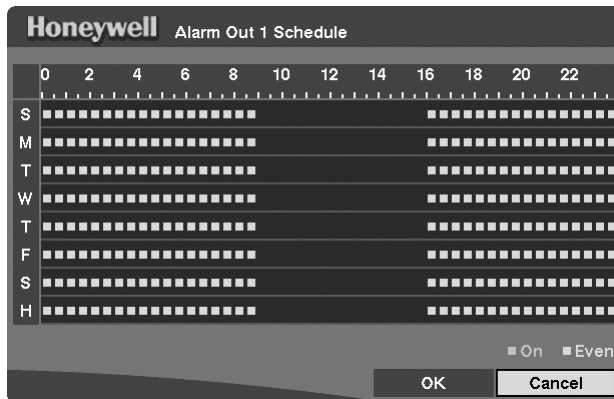

You can select individual blocks of time, entire days of the week, entire blocks of time, or the entire schedule.

- Select a specific block of time by highlighting it and then pressing \leftarrow .
- Select an entire day by highlighting the day of the week or Holiday on the left of the screen and then press \leftarrow .
- Select an entire block of time by highlighting the time period at the top of the screen and then press \leftarrow .
- Select the entire screen by highlighting the empty box in the upper left corner of the screen. Press \leftarrow to toggle between **No Arming** (no block) to **On** (blue block) to **Event** (yellow block).

On means the Alarm Out is active during the scheduled time.

Event indicates the Alarm Out is only active when there is an Event during the scheduled time.

Audio Setup Screen

Use the Audio Setup screen to set the DVR to record audio when it is recording video. Highlight **Audio** in the Device menu (**MENU** \blacktriangleright **Device** \blacktriangleright **Audio**) and then press \leftarrow . The Audio Setup screen displays.

Figure 3-28 Audio Setup Screen

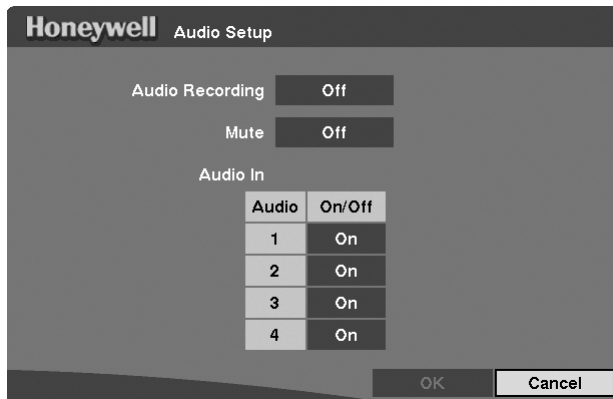

1. Highlight the box beside **Audio Recording** and then press \leftarrow . This toggles between **On** and **Off**. When it is **On**, the DVR also records audio when it is recording video.
2. Highlight the box beside **Mute** and then press \leftarrow . This toggles between **On** and **Off**. When it is **On**, the DVR does **not** play live or recorded audio.
3. The DVR supports four audio inputs. You can set up each input. When it is **On**, the DVR plays live audio through the attached speaker when it displays live video. Highlight the **Audio In** field, highlight the box under the **On/Off** heading, and then press \leftarrow . This toggles between **On** and **Off**.
4. To save your changes, highlight **OK** and then press \leftarrow . Select **Cancel** to exit the screen without saving the changes.

Note The DVR will NOT record audio when the recording speed is set to less than 15 ips (12.5 ips PAL). The DVR may not record audio depending on the Transfer Speed when the RAS (Remote Administration System) Watch program is connected.

RS232/RS485 Setup Screen

Use the RS232/RS485 Setup screen to set up the RS232 and RS485 ports to communicate with external devices such as remote controls, and dome cameras. Highlight **RS232/RS485** in the Device menu (**MENU** \blacktriangleright **Device** \blacktriangleright **RS232/RS485**) and then press \leftarrow . The RS232/RS485 screen displays.

Figure 3-29 RS232/RS485 Screen

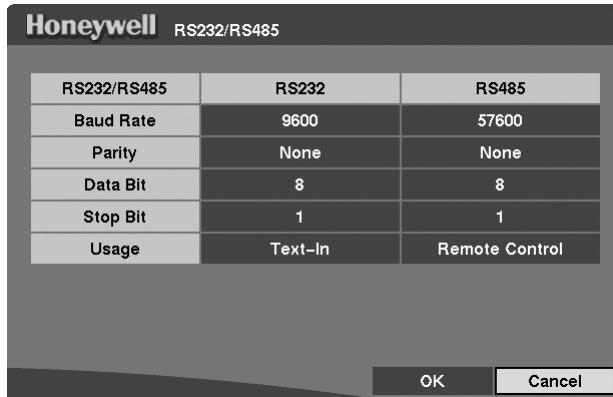

1. Highlight the field for the settings you wish to make. Select the correct Baud Rate, Parity, Data Bit, and Stop Bit for the device you are connecting to the DVR.
2. For RS232, it is possible to select either **Remote Control**, **External Modem**, or **Text-In** in the **Usage** field.

For RS485, it is possible to select either **Remote Control** or **PTZ Control** in the **Usage** field.

Note Selecting **External Modem** in the RS232 field only defines the RS232C port as being used for external modem connections. See *Modem Setup*, page 65 for details on setting up an external modem.

Note Selecting **PTZ Control** in the RS485 field only defines the RS485 port as being used for PTZ camera connections. Select the PTZ device in the Camera Setup screen (see *Camera Setup Screen*, page 34).

Note If networking is configured by the external modem, Text-In cannot be set for the RS232 field. In the Network Setup screen, set up the DVR for LAN communications first (see *Network Setup Screen*, page 60).

Configuring Recording Settings

Note When the DVR is recording video, the REC LED on the front panel is lit and a red dot appears on the monitor.

Your DVR offers a variety of flexible recording modes:

- You can set it up to record all the time or to only record events.
- It can be set up to continue recording after the hard disk drive is full by recording over the oldest video.
- You can set it up to alert you when the hard disk is full and stop recording.

Record Mode Setup Screen

Access the Record Mode Setup screen (**MENU** ► **Record** ► **Record Mode**). The Record Mode Setup screen displays.

Figure 3-30 Record Mode Setup Screen

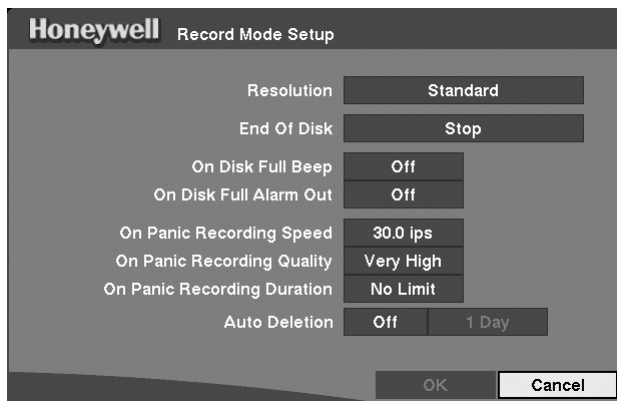

1. Highlight the box beside **Resolution** and then press ←. This toggles between **Standard** and **High**.

Note The maximum recording speed is 30 images per second (25 ips for PAL) when the resolution is set to **Standard**. However, when set to **High**, the recording speed will decrease to 15 images per second (12.5 ips for PAL).

2. Highlight the box beside **End Of Disk** and then press \leftarrow . This toggles between **Overwrite** and **Stop**.
In **Overwrite** mode, the DVR continues recording when the hard disk drive is full by overwriting the oldest video.
In **Stop** mode, the DVR stops recording when the hard disk drive is full.
3. If the DVR is set to Stop mode, you can set it to beep or activate the Alarm Out port when the hard disk drive is full. Highlight the box beside **On Disk Full Beep** and press \leftarrow to toggle between **On** and **Off**. Highlight the box beside **On Disk Full Alarm Out** and then press \leftarrow to toggle between **On** and **Off**.
4. Pressing the **PANIC** button on the front panel causes the DVR to enter Panic Recording mode. You can program the recording speed, quality and duration when the DVR is in Panic Recording mode.
 - a. Set the **On Panic Recording Speed** field from 0.5 to 30 ips (25 ips PAL).
 - b. Set the **On Panic Recording Quality** field to **Very High**, **High**, **Standard**, or **Low**.
 - c. Set the **On Panic Recording Duration** field from 5 to 60 minutes.
The panic recording will be stopped automatically according to the preset duration as long as **PANIC** is not pressed to stop the panic recording. Select **No Limit** if you want to stop panic recording manually.

Note When the DVR is in Panic Recording mode, it ignores time-lapse or event recording settings and follows the panic recording settings.

The maximum panic recording speed is 30 images per second (25 ips for PAL) when the resolution is set to Standard. However, when set to High, the recording speed decreases to 15 ips (12.5 ips for PAL).

When the DVR is recording video, a red dot appears on the screen. When the DVR is in Panic Recording mode, a white ! appears in the red dot and the REC LED on the front panel flickers.

5. Highlight the box beside **Auto Deletion**. Press \leftarrow . to toggle between **On** and **Off**.
When set to **On**, the DVR deletes video recorded earlier than the user-defined period. Highlight the second box beside Auto Deletion and then press \leftarrow . to select the length of time recorded data will be kept, from **1** to **99** days.

Caution When the End of Disk is set to **Stop**, the DVR will NOT restart recording, even after video recorded earlier than the user-defined period is deleted.

- To save your changes, highlight **OK** and then press \leftarrow . Selecting **Cancel** exits the screen without saving the changes.

Time-Lapse Record Mode Setup Screen

Access the Time-Lapse Record Setup screen (**MENU** \blacktriangleright **Record** \blacktriangleright **Time-Lapse Record**). The Time-Lapse Record Setup screen displays.

Figure 3-31 Time-Lapse Record Setup Screen

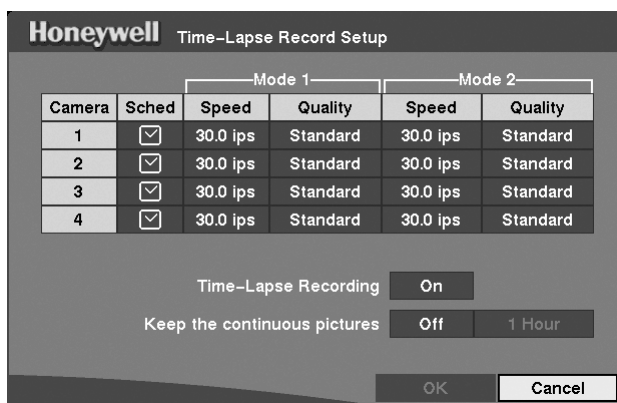

- Highlight the box under the **Speed** heading and then press \leftarrow . A drop-down list of recording speeds displays. You can select from 0.5 ips to 30 ips (25 ips for PAL).

Note You cannot select 30 ips (25 ips for PAL) if the **Resolution** is set up to **High** or **Very High** in the Record Mode Setup screen.

- Highlight the box under the **Quality** heading and then press \leftarrow . A drop-down list displays. You can select from **Very High**, **High**, **Standard**, and **Low** image quality. All other variables being equal, Very High will require 300% more hard disk space than Standard, High will require 200% more, and Low 50% less.

Note Higher quality images require more storage space and reduce the recording capacity of the hard disk drive.

3. You can set the DVR to record video based on Time-lapse Recording Schedule defined during Time-Lapse Record Setup. Highlighting the box beside **Time-Lapse Recording** and pressing \leftarrow toggles between **On** and **Off**.
4. You can set the maximum amount of time-lapse video to be stored. After the DVR reaches this amount, it will start recording over the oldest time-lapse video. The time-lapse video is stored separate from Event video. When **Keep the continuous pictures** is set to **On**, you can set the time from **1 Hour** to the maximum allowed by the storage capacity of your hard disk drive.

Note The maximum storage time is only an estimate because the amount of space required to store video varies depending on factors such as motion and image complexity.

Time-Lapse Recording Schedule

Figure 3-32 Time-Lapse Recording Schedule Screen

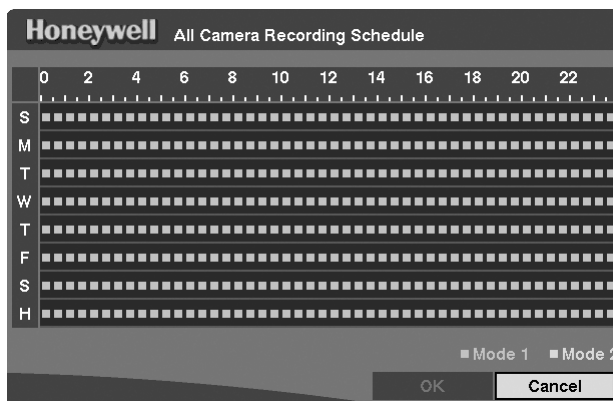

You can program the DVR to record only during certain times based on time, day of the week, and holidays. The smallest time segment you can use is 30 minutes. A blue rectangle indicates the DVR is set to record during those 30 minutes. When there is no rectangle, the DVR will not record during those 30 minutes.

There are several ways to set recording times:

- You can highlight an individual block and toggle it On or Off by pressing \leftarrow .
- You can change a 30-minute segment for all days by placing the cursor on the time line and then pressing \leftarrow to toggle the segment On or Off.
- You can change an entire day by placing the cursor on the day of the week and then pressing \leftarrow to toggle the day On or Off.
- You can change the entire calendar by placing the cursor in the upper left-hand box (above S and to the left of the time line) and then pressing \leftarrow to toggle the entire calendar On and Off.

Note The Holiday (H) schedule applies to the dates you established as holidays when setting Date/Time.

To save your changes, highlight **OK** and then press **↵**. Select **Cancel** to exit the screen without saving the changes.

Pre-Event Recording Setup Screen

When the DVR is in the Event Record mode it is possible to have it record images before the event occurs. Use the Pre-Event Record Setup screen (**MENU** ► **Record** ► **Pre-Event Record**) to define how to handle pre-event recording.

Figure 3-33 Pre-Event Recording Setup Screen

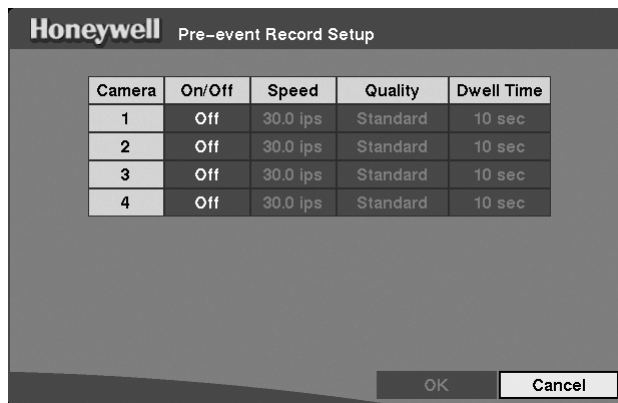

You can turn individual cameras **On** or **Off** for pre-event recording. You can set the image speed from **0.5** to **30** ips NTSC (25 ips PAL), and image quality from **High**, **Standard**, and **Low**.

Note The pre-event recording speed is 30 images per second (25 ips for PAL) when the resolution is set to **Standard** in the Record Mode Setup screen. However, when set to **High** or **Very High**, the recording speed decreases to 15 images per second (12.5 ips for PAL).

You can set the amount of time to record prior to the event by adjusting the Dwell time. You can set the Dwell time from **1** to **300** seconds.

Note When the DVR is in the Time-Lapse mode, it ignores the pre-event settings and follows the time-lapse settings. In this case, Pre-Event time will not be added to the Event clip.

Event Action Setup

You can program the DVR to record, activate the alarm output, and/or notify the remote site whenever sensor, motion, text, or video loss events are detected. To access the Event Action screens, highlight the Alarm-In Action, Motion Action, Text-In Action, or Video Loss Action in the Event Action menu (**MENU** ► **Event Action**). The following Event Action setup screens display.

Alarm In Event Action (Record) Setup Screen

The DVR can be set to react to events differently. Each sensor can be assigned a schedule, camera, recording speed, video quality, and dwell time.

Figure 3-34 Alarm In Event Action Screen

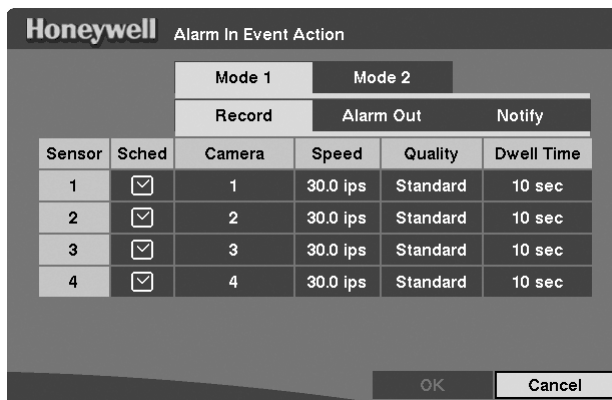

1. Highlight the **Sched** box and then press **←**. A schedule screen displays. Set the schedule as described earlier, under *Time-Lapse Recording Schedule*, page 47.
2. Highlight the **Camera** box and then press **←**. A camera selection screen displays. Select the camera number you would like to associate with the sensor (Alarm Input).

Note You can associate multiple cameras with a sensor (Alarm Input).

3. Highlight the **Speed** box and select number of images per second you would like to record from the drop-down list.
4. Highlight the **Quality** box and select the image quality you want to record from the drop-down list.
5. Highlight the **Dwell Time** box and set the length of time you would like to record for the associated event.

Alarm In Event Action (Alarm Out) Setup Screen

Use this screen to set how the DVR reacts to events differently by activating an internal buzzer or external alarms.

Figure 3-35 Alarm In Event Action (Alarm Out) Screen

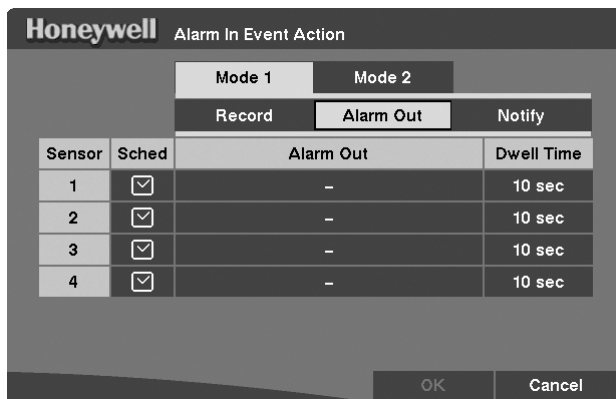

1. Highlight the **Sched** box and then press \leftarrow . A schedule screen displays. Set the schedule as described earlier.
2. Highlight the **Alarm Out** box and select either Beep and/or the alarm output terminal that you want to associate with the sensor.
3. Highlight the **Dwell Time** box and set the length of time you want the output activated.

Alarm In Event Action (Notify) Setup Screen

Use this screen to set the DVR to notify the remote site when certain events are activated.

Figure 3-36 Alarm In Event Action (Notify) Setup Screen

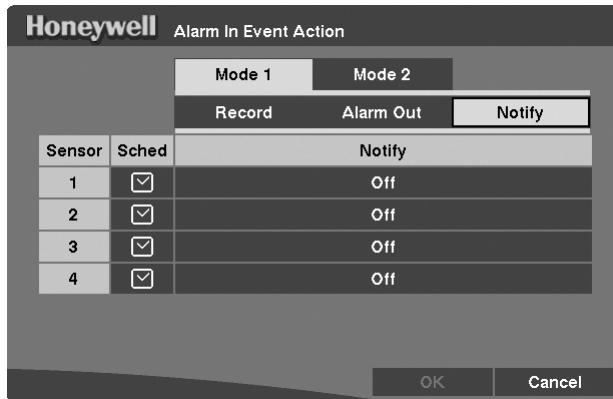

1. Highlight the **Sched** box and then press \leftarrow . A schedule screen displays. Set the schedule as described earlier.
2. Highlight the **Notify** box and then press \leftarrow . This toggles between **On** and **Off**. When it is **On**, the DVR notifies the remote site when certain events occur based on a defined schedule.

Note For the Notify action to work, the DVR should be registered in the RAS (Remote Administration System).

Motion Detector Event Action (Record) Setup Screen

Use this screen to set the DVR to react to motion detection differently than other events. You can assign each camera a schedule, associated camera, recording speed, video quality, and dwell time.

Figure 3-37 Motion Detector Event Action (Record) Setup Screen

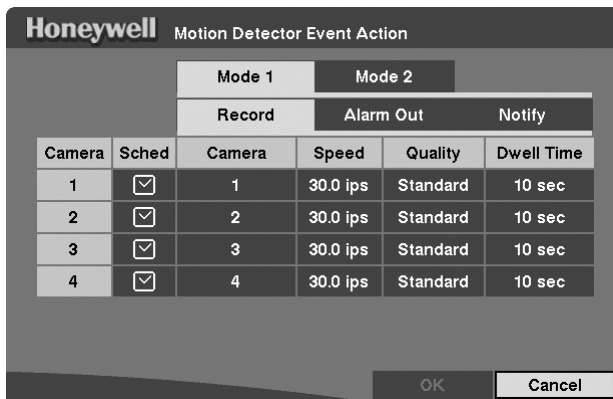

1. Highlight the **Sched** box and then press \leftarrow . A schedule screen displays. Set the schedule as described earlier.
2. Highlight the **Camera** box and then press \leftarrow . A camera selection screen displays. Select the camera number you would like to associate with the camera that has detected motion.

Note You can associate multiple cameras with a camera that detects motion.

3. Highlight the **Speed** box and select number of images per second you would like to record from the drop-down list.
4. Highlight the **Quality** box and select the image quality you want to record from the drop-down list.
5. Highlight the **Dwell Time** box and set the length of time you would like to record for the associated motion event.

Motion Detector Event Action (Alarm Out) Setup Screen

Use this screen to set the DVR to react to motion events differently by activating an internal buzzer and/or external alarms.

Figure 3-38 Motion Detector Event Action (Alarm Out) Screen

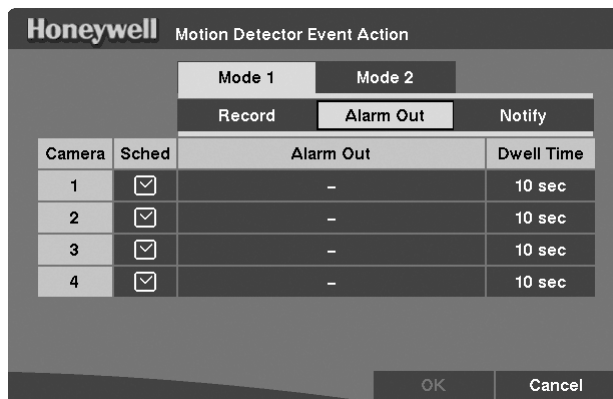

1. Highlight the **Sched** box and then press \leftarrow . A schedule screen displays. Set the schedule as described earlier.
2. Highlight the **Alarm Out** box and select either **Beep** and/or the alarm output terminal that you want to associate with the motion event.
3. Highlight the **Dwell Time** box and set the length of time you want the output activated.

Motion Detector Event Action (Notify) Setup Screen

Use this screen to set the DVR to notify the remote site when certain motion events are activated.

Figure 3-39 Motion Detector Event Action (Notify) Screen

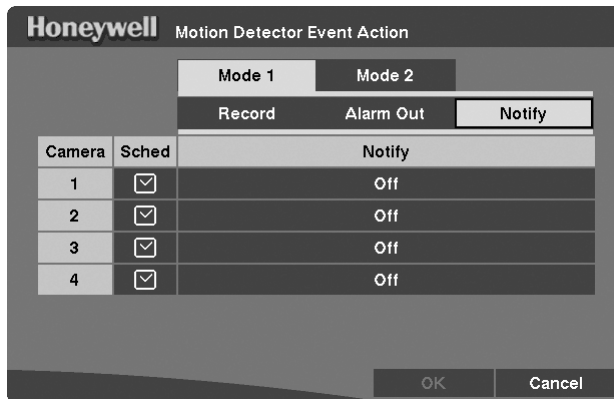

1. Highlight the **Sched** box and then press ←. A schedule screen displays. Set the schedule as described earlier.
2. Highlight the **Notify** box and then press ←. This toggles between **On** and **Off**. When it is **On**, the DVR notifies the remote site when certain events occur based on a defined schedule.

Note For the Notify action to work, the DVR should be registered in the RAS (Remote Administration System).

Text-In Event Action (Record) Setup Screen

Use this screen to set how the DVR reacts to text input from the text-in device. You can assign the text-in a schedule, associated camera, recording speed, video quality, and dwell time.

Figure 3-40 Text-In Event Action (Record) Screen

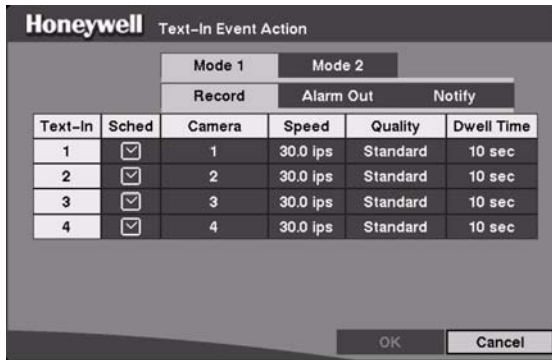

1. Highlight the **Sched** box and then press \leftarrow . A schedule screen displays. Set the schedule as described earlier.
2. Highlight the **Camera** box and then press \leftarrow . A camera selection screen displays. Select the camera number you would like to associate with the text-in device.

Note You cannot associate multiple cameras with a text-in device.

3. Highlight the **Speed** box and select the number of images per second you would like to record from the drop-down list.
4. Highlight the **Quality** box and select the image quality you want to record from the drop-down list.
5. Highlight the **Dwell Time** box and then set the length of time you would like to record for the text input.

Text-In Event Action (Alarm Out) Setup Screen

Use this screen to set how the DVR reacts to text-in by activating an internal buzzer and/or external alarms.

Figure 3-41 Text-In Event Action (Alarm Out) Screen

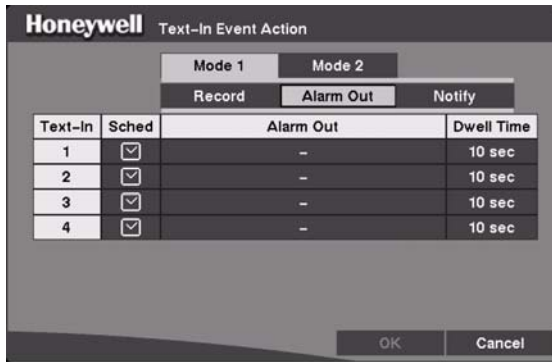

1. Highlight the **Sched** box and then press \leftarrow . A schedule screen displays. Set the schedule as described earlier.
2. Highlight the **Alarm Out** box and select either **Beep** or the alarm output terminal that you want to associate with the motion event.
3. Highlight the **Dwell Time** box and set the length of time you want the output activated.

Text-In Event Action (Notify) Setup Screen

Use this screen to set the DVR to notify the remote site in the case of a text-in event.

Figure 3-42 Text-In Event Action (Notify) Screen

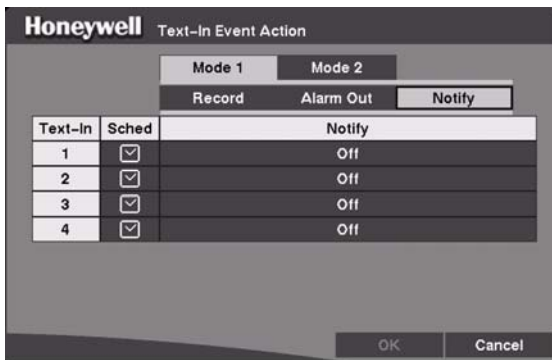

1. Highlight the **Sched** box and then press \leftarrow . A schedule screen displays. Set the schedule as described earlier.
2. Highlight the **Notify** box and then press \leftarrow . This toggles between **On** and **Off**. When it is **On**, the DVR notifies the remote site when it has text input from a text-in device based on a defined schedule.

Note For the Notify action to work, the DVR should be registered in the RAS (Remote Administration System).

Video Loss Event Action (Record) Setup Screen

Use this screen to set the DVR to react to video loss from a camera differently. Each camera can be assigned a schedule, associated camera, recording speed, video quality and dwell time.

Figure 3-43 Video Loss Event Action (Record) Screen

Honeywell Video Loss Event Action					
		Mode 1	Mode 2		
		Record	Alarm Out	Notify	
Camera	Sched	Camera	Speed	Quality	Dwell Time
1	<input checked="" type="checkbox"/>	-	30.0 ips	Standard	10 sec
2	<input checked="" type="checkbox"/>	-	30.0 ips	Standard	10 sec
3	<input checked="" type="checkbox"/>	-	30.0 ips	Standard	10 sec
4	<input checked="" type="checkbox"/>	-	30.0 ips	Standard	10 sec

OK Cancel

1. Highlight the **Sched** box and then press \leftarrow . A schedule screen displays. Set the schedule as described earlier.
2. Highlight the **Camera** box and then press \leftarrow . A camera selection screen displays. Select the camera number you would like to associate with the camera that has lost video.

Note You can associate multiple cameras with a camera that has detected a loss of video.

3. Highlight the **Speed** box and select number of images per second you would like to record from the drop-down list.
4. Highlight the **Quality** box and select the image quality you want to record from the drop-down list.
5. Highlight the **Dwell Time** box and set the length of time you would like to record for the associated video loss.

Video Loss Event Action (Alarm Out) Setup Screen

You can set the DVR to react to video loss differently by activating an internal buzzer or external alarms.

Figure 3-44 Video Loss Event Action (Alarm Out) Screen

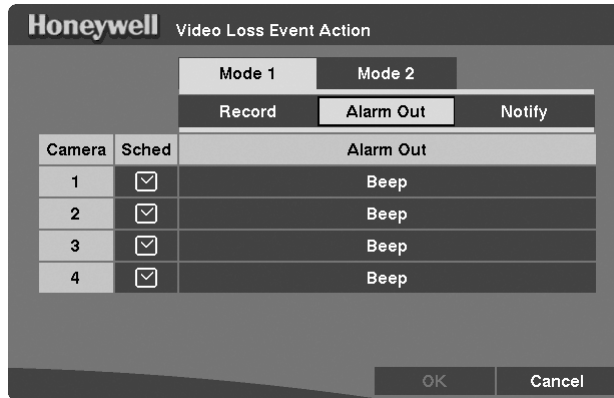

1. Highlight the **Sched** box and then press \leftarrow . A schedule screen displays. Set the schedule as described earlier.
2. Highlight the **Alarm Out** box and select either **Beep** and/or the alarm output terminal that you want to associate with the camera that has lost video.

Video Loss Event Action (Notify) Setup Screen

Use this screen to set the DVR to notify the remote site in the case of video loss.

Figure 3-45 Video Loss Event Action (Notify) Screen

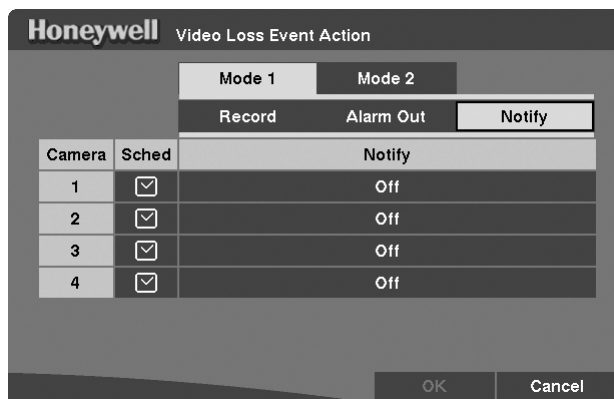

1. Highlight the **Sched** box and then press \leftarrow . A schedule screen displays. Set the schedule as described earlier.
2. Highlight the **Notify** box and then press \leftarrow . This toggles between **On** and **Off**.

When it is **On**, the DVR notifies the remote site when it loses video input from a camera based on a defined schedule.

Note For the Notify action to work, the DVR should be registered in the RAS (Remote Administration System).

Display Setup

Highlight OSD or Main Monitoring in the Display menu, and then press \leftarrow to set up the on-screen display or camera display on the main monitor.

OSD (On-Screen Display) Setup

Use the OSD Setup screen (**MENU** \blacktriangleright **Display** \blacktriangleright **OSD**) to set the DVR to display Date, Time, Title and Status on screen. Each feature can be turned on or off. You can also set up where you want the video to display on the screen by adjusting the margins.

Figure 3-46 OSD Setup Screen

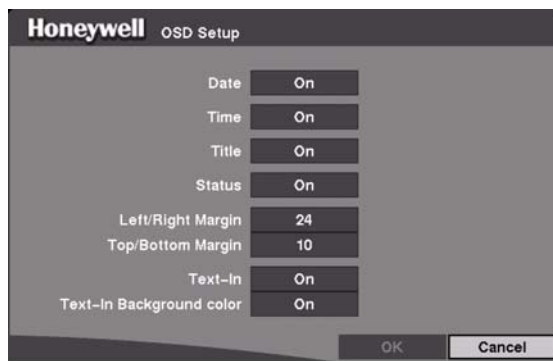

1. Highlight the box beside **Date** and then press \leftarrow to toggle the date display **On** and **Off**.
2. Highlight the box beside **Time** and then press \leftarrow to toggle the time display **On** and **Off**.
3. Highlight the box beside **Title** and then press \leftarrow to toggle the camera title display **On** and **Off**.

4. Highlight the box beside **Status** and then press \leftarrow to toggle status display **On** and **Off**.
5. Highlight the box beside **Left/Right Margin** and then press \leftarrow to adjust the left and right margins. The margins can be set from **1** to **24**.
6. Highlight the box beside **Top/Bottom Margin** and then press \leftarrow to adjust the top and bottom margins. The margins can be set from **1** to **24**.
7. Highlight the box beside **Text-In** and then press \leftarrow to toggle the text-in data display **On** and **Off**.
8. If you want to read text input strings displayed on the screen easily and clearly, turn **On** Text-In Background color. Highlight the box beside **Text-In Background color** and then press \leftarrow to toggle between **On** and **Off**.

Main Monitoring Setup Screen

Use the Main Monitoring Setup screen (**MENU** \blacktriangleright **Display** \blacktriangleright **Main Monitoring**) to adjust the display dwell time for each camera displayed on the main monitor. You can also set the video from the event-detected cameras to be displayed on the main monitor during the preset dwell time.

Figure 3-47 Main Monitoring Setup Screen

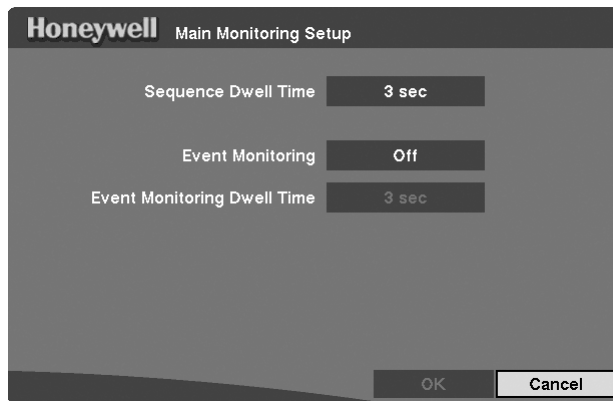

1. Highlight the box beside **Sequence Dwell Time** and then press \leftarrow . You can adjust the sequence dwell time from **3** to **60** seconds.

Note The DVR does not sequence a camera experiencing video loss.

2. Highlight the box beside **Event Monitoring** and then press \leftarrow to toggle between **On** and **Off**. When it is **On**, the video of the lowest camera number among cameras associated with the event-detected sensor will be displayed in full-screen on the main monitor during the preset dwell time.
3. Highlight the box beside **Event Monitoring Dwell Time** and then press \leftarrow . You can adjust the event monitoring dwell time from **3** to **60** seconds.

Network Setup Screen

Use the Network Setup screen (**MENU** ► **Network** ► **Network Setup**) to set up the DVR for LAN and modem connections.

Figure 3-48 Network Setup Screen

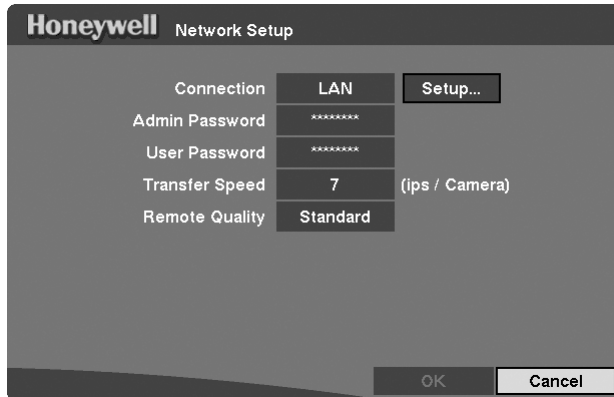

1. Highlight the box beside **Connection**. Press **←** to toggle between **LAN** and **Modem**.
2. Highlight the box beside **Admin Password** and then press **←**. A virtual keyboard displays (see [Figure 3-7](#)). You will first be asked to enter the current password. Then you can enter a new password; you will be asked to confirm the new password before it is accepted.
3. Highlight the box beside **User Password** and then press **←**. A virtual keyboard displays. You will first be asked to enter the current password. Then you can enter a new password; you will be asked to confirm the new password before it is accepted.

Note These passwords are for network use only. They are different from the Admin and User passwords for the DVR itself.
The passwords are case sensitive. The factory default password for both Administrator and User is **12345678**.

Caution Write the password down and keep it in a safe place. After the password has been reset, the default will no longer work. If the password is forgotten, the unit must be reset using the Factory Reset Button and all data settings will be lost.

- The Transfer Speed indicates the image rate transferred to each RAS. Highlight the box beside **Transfer Speed**, press \leftarrow then adjust the number.

Note The maximum transfer speed over a LAN is 30 images per second (25 ips for PAL) when the resolution is set to Standard. However, when set to High the transfer speed will decrease to 15 images per second (12.5 ips for PAL).

Caution Selecting the maximum transfer speed will STOP video recording. Adjust the transfer speed if you want to continue the recording.

- You can program the image quality for transferring to RAS. Highlight the box beside **Remote Quality** and then press \leftarrow . You can set the image quality to **Very High**, **High**, **Standard**, or **Low**.

LAN Setup Screen

Use the LAN Setup screen to configure your Local Area Network.

Figure 3-49 LAN Setup Screen

Honeywell LAN Setup	
Type	Manual
IP Address	192.168.1.129
Gateway	192.168.1.254
Subnet Mask	255.255.255.0
DNS Server	
Port Number Setup...	
OK Cancel	

Highlight the box beside **Type** and then press \leftarrow .to select from **Manual**, **DHCP**, and **ADSL (PPPoE)**.

Selecting **Manual** from Type allows you to set up LAN parameters manually.

LAN Setup — Manual

Note Obtain the appropriate IP Address, Gateway and Subnet Mask from your network administrator.

Change the numbers by highlighting them and using the Up and Down Arrow buttons or the Jog Dial to increase or decrease the numbers.

The factory default LAN settings are:

IP Address	192.168.1.129
Gateway	192.168.1.254
Subnet Mask	255.255.255.0

1. Highlight the box beside **DNS Server** and then press ←.to enter the IP address of the DNS server. If you set the DNS Server, the domain name of the DVRNS server instead of the IP address can be used during the DVRNS Server setup. See *DVRNS (DVR Name Service) Setup Screen*, page 66 for detailed information on DVRNS Server setup.
2. Highlight **Port Number Setup ...** and then press ←to display the Port Number Setup screen.

Figure 3-50 Port Number Setup Screen

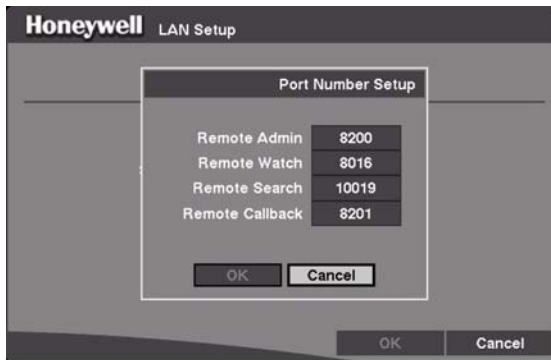

Note Obtain the appropriate Port Number for each RAS related program (Admin, Watch, Search, and Callback) from your network administrator.

To change the number, highlight it and use the Up and Down arrow buttons to increase or decrease the number.

The factory default Port settings are:

Remote Admin:	8200
Remote Watch:	8016
Remote Search:	10019
Remote Callback:	8201

Note The system restarts automatically after changing the port settings.

Note Do NOT use the same port number for two different programs, otherwise, the DVR cannot be connected with a PC running RAS.

Caution When changing the port settings, you must change the port settings on the PC running RAS as well. Refer to the *Remote Administration System (RAS) User Guide* for details.

To save your changes and return to the Network Setup screen, highlight **OK** and then press ↵. Select **Cancel** to exit the screen without saving the changes.

LAN — DHCP

Selecting **DHCP** from the Type box on the LAN Setup screen, and highlighting **OK** reads the current IP Address of the DVR configured by the DHCP (Dynamic Host Configuration Protocol) network.

Figure 3-51 LAN (DHCP) Setup Screen

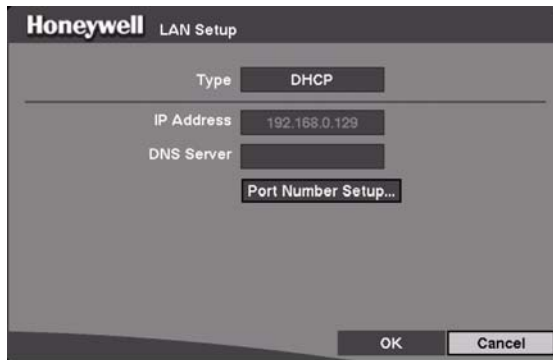

LAN — ADSL (PPPoE)

Select **ADSL (PPPoE)** from the Type box on the LAN Setup screen to set up the ADSL network.

Note ADSL and modem cannot be configured at the same time. If the DVR is networked via modem, the ADSL (PPPoE) will not be selected.

Figure 3-52 LAN (ADSL) Setup Screen

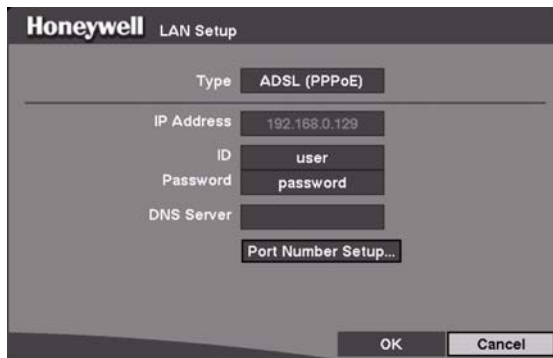

1. Highlight the box beside **ID** and then press **↵** to display a virtual keyboard. Enter the ID for an ADSL connection.
2. Highlight the box beside **Password** and then press **↵** to use the virtual keyboard to enter the password for an ADSL connection.

Note Entering the ID and Password and highlighting **OK** reads the current IP Address of the DVR configured by the ADSL network.

Note If the DVR is configured for DHCP or an ADSL network, the IP Address of the DVR might change whenever the unit is turned on.

Modem Setup

Use the Modem Setup screen to configure your modem.

Figure 3-53 Modem Setup Screen

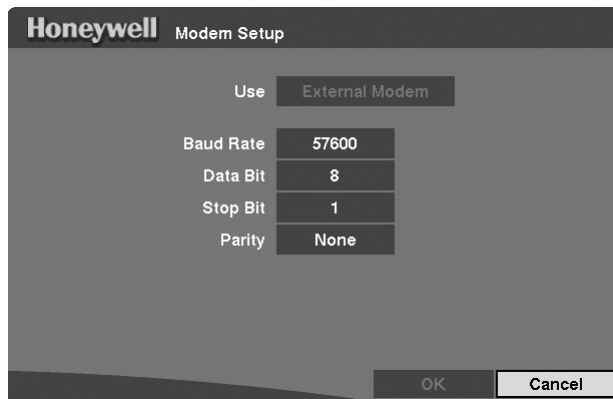

The Use field displays the available modem type: **External Modem**.

1. Highlight the box beside **Baud Rate** of the RS232 field and then press \leftarrow . A list of baud rates ranging from **300** to **115,200** displays.
2. Highlight the box beside **Data Bit** of the RS232 field. Press \leftarrow to toggle between **7** bit and **8** bit formats.
3. Highlight the box beside **Stop Bit** of the RS232 field. Press \leftarrow to toggle between **1** and **2** Stop Bits.
4. Highlight the box beside **Parity** of the RS232 field and then press \leftarrow . A drop-down list displays. You can select from **None**, **Odd**, or **Even** parity.
5. To save your changes, highlight **OK** and then press \leftarrow . Select **Cancel** to exit the screen without saving the changes.

DVRNS (DVR Name Service) Setup Screen

DVRNS allows the DVR to use dynamic IP addresses for remote connection. Use the DVRNS Setup screen to configure the DVRNS server and register the DVR to use DVR name service.

Figure 3-54 DVRNS Setup Screen

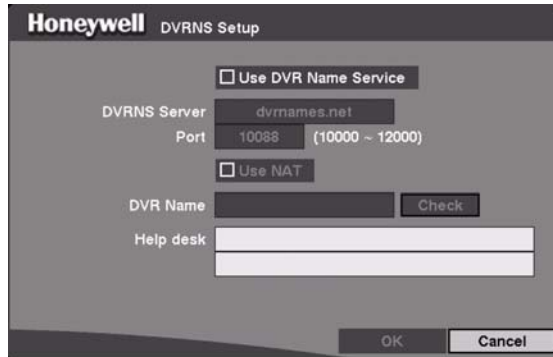

1. Highlight the box beside **Use DVR Name Service** and then press \leftarrow to toggle between **On** and **Off**,
2. Highlight the box beside **DVRNS Server** and enter the IP address or domain name of the DVRNS server

Note Obtain the appropriate IP address or domain name of the DVRNS Server from your network administrator.

You can use the domain name instead of the IP address if you have already set up the DNS Server during the LAN setup.

3. Highlight the box beside **Port** and enter the port number of the DVRNS server. The port number can be set from **10000** to **12000**.

Note The DVRNS server settings on your DVR should match the settings on the registered DVRNS server. Any changes on the DVRNS server might cause improper operation.

4. Highlight the **Use NAT** box and then press \leftarrow to toggle between **On** and **Off**. Turn on **Use NAT** when the DVR is networking using the NAT (Network Address Translation) device.

Note When using the NAT device, refer to the NAT manufacturer's instructions for the appropriate network settings.

5. Highlight the box beside **DVR Name** and then press \leftarrow to name the DVR to be registered on the DVRNS server. A virtual keyboard allows you to enter the DVR name.
6. Selecting **Check** allows you to check whether or not the name you entered can be used.

Note The DVR name you entered should be checked by selecting **Name Check**; otherwise, the DVRNS changes will not be saved.

When entering no name or a name already registered on the DVRNS server, an error message displays.

7. Highlight **OK** and then press \leftarrow to register the DVR on the DVRNS server. Proper DVRNS settings display the help desk information of the DVRNS server in the box beside **Help Desk**.

Caution If you want to use the same DVR name registered on the DVRNS server after initializing the system using the factory reset, you need to contact the DVRNS server manager. Please record and save the help desk information before performing a factory reset.

The DVRNS registration is limited to one DVRNS server. The DVR cannot be registered to multiple DVRNS servers. Please contact your network administrator when you want to register the DVR to another DVRNS server.

Callback Center Setup Screen

You can set up the DVR to contact a computer running RAS (Remote Administration System) on a LAN when an event occurs. You can also set it up to dial a pager with a numeric message when an event occurs if you have a modem connected to the DVR.

Callback Center Setup by LAN Connections

Highlight **Callback Center** (**MENU** ► **Network** ► **Callback Center**) and then press **↵**. The Callback Center Setup screen displays.

Figure 3-55 **Callback Center Setup Screen**

Honeywell Callback Center Setup	
IP Address	192.168.1.10
Retry	3
<hr/>	
E-mail notification	Off
SMTP Server IP	192.168.1.254
E-mail recipient	root@192.168.1.129
E-mail sender	dvr@192.168.1.129
Authentication	Off
ID	
Password	*****
<input type="button" value="OK"/> <input type="button" value="Cancel"/>	

1. Highlight the box beside **IP Address** and enter the IP address of the computer you want contacted during an event.
2. Highlight the box beside **Retry** and enter the number of times you would like the DVR to try contacting the computer. You can select from **1** to **10** retries.
3. Highlight the box beside **E-mail notification** and then press **↵** to toggle between **On** and **Off**.
4. Highlight the box beside **SMTP Server IP** and enter the SMTP server IP address, obtained from your system administrator.
5. Highlight the box beside **E-mail recipient** and enter the recipient's e-mail address. Use the virtual keyboard (see *Figure 3-7*) to enter the e-mail address.
6. Highlight the box beside **E-mail sender** and enter the sender's e-mail address.

Note The e-mail address must include the character @ to be a valid address.

7. Highlight the box beside **Authentication** and press **↵** to toggle between **On** and **Off**.
8. Highlight the box beside **ID** and enter the **SMTP ID**. A virtual keyboard appears, allowing you to enter the ID.
9. Highlight the box beside **Password** and enter the SMTP password. A virtual keyboard appears, allowing you to enter the password.

Note **Authentication** should be turned On and **ID** and **Password** should be entered when using the SMTP server requiring user authentication.

Callback Center Setup by Modem Connections

Figure 3-56 Callback Center (Modem) Setup Screen

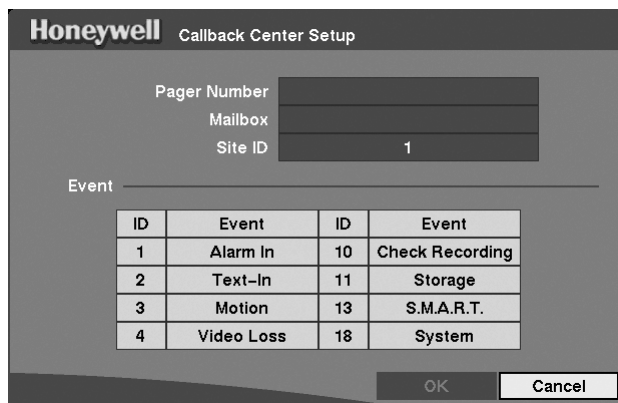

1. Highlight the box beside **Pager Number** and enter the telephone number of the pager. Enter the number as it must be dialed from your telephone system; for example, if you must dial 9 for an outside line, enter **9** before the pager number.
2. Highlight the box beside **Mailbox** and enter the voice mailbox number if your pager uses a voice mailbox.
3. Highlight the box beside **Site ID** and enter a site ID number with up to 3 digits.

When an event occurs, the DVR dials the pager and leaves a four- or five-digit number. The first three digits are the site ID number and the last digits are the type of event (1: Alarm In, 2: Text-In, 3: Motion Detection, 4: Video Loss, 10: Check Recording, 11: Storage, 13: S.M.A.R.T. and 18: System). For example, 0754 means that Site 75 has lost video.

Note The DVR waits for at least four minutes between pages. If another event occurs less than four minutes after the DVR has notified a pager, it will not dial the pager. It does this so that the telephone line is not tied up.

4. To save your changes, highlight **OK** and then press **↵**. Select **Cancel** to exit the screen without saving the changes.

Password Setup Screen

An Administrator password is required to:

- Turn the system off
- Enter the setup screen
- Load default setups
- Clear all data
- Change system date and time
- Change the Administrator password

A User password is required to:

- Enter playback, fast forward playback and fast backward playback modes from Live Monitoring mode.
- Enter the search menu screen in Live Monitoring mode.

Highlight **Password** in the Main Menu (**MENU ► Password**) and then press \leftarrow to display the Password screen.

Figure 3-57 Password Setup Screen

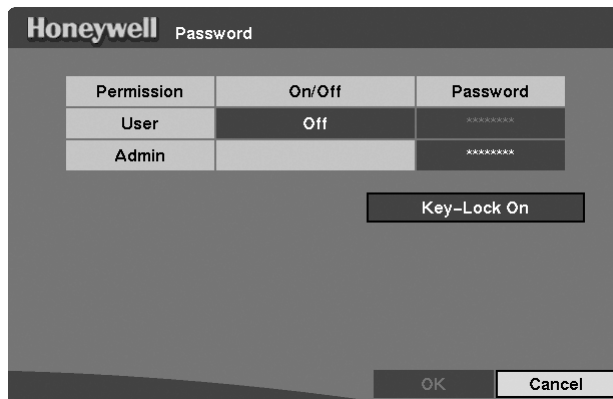

1. Highlight the box beside **User** and then press \leftarrow to toggle between **On** and **Off**.
 If the password is set to **On**, you will be asked to enter the current password so that you can turn it off.
 If the password is set to **Off**, you will be asked to enter the new password and to confirm it before it will be turned on.
2. The Administrator password cannot be turned On and Off. You can change the Administrator password by first entering the current password, entering a new password, and then confirming the new password.

To change the password, highlight the box below **Password**, and then press ↵. A window displays asking you to enter the current password. If you enter the correct password, another window displays asking you to enter a new password using the camera buttons. After you press ↵, another screen displays asking you to confirm the new password.

Note The Admin and User passwords are composed of up to eight digits using the camera buttons. The default User password is **1234**, and Admin password is **4321**.

Caution Write down the new password and save it in a secure place. If the password is forgotten, the unit must be reset using the Factory Reset Button and all data settings will be lost.

3. To lock front panel buttons, highlight **Key-Lock On** and then press ↵. After the buttons are locked, pressing any front panel button will cause a password screen to display. You will need to enter the correct password to unlock the keys. The Key Lock password is **4231**. The Administrator and User password also can be used to unlock the keys.
4. To save your changes, highlight **OK** and then press ↵. Select **Cancel** to exit the screen without saving the changes.

Config (Configuration) Menu

Use the Config menu (**MENU ► Config**) to perform functions such as:

- Switch between Quick Setup and Normal Setup
- Copy video clips
- Load default setup
- Clear all data

Figure 3-58 Config Menu

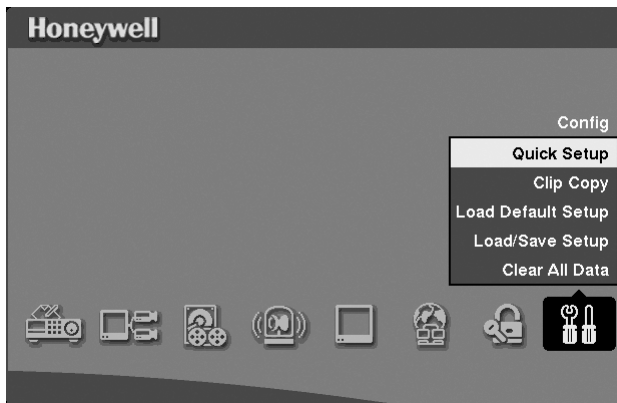

Clip Copy

Use the Clip Copy screen to copy video to an internal CD-RW drive, or external USB hard disk drive, or USB flash drive. The copied clip images can be viewed on computers running Microsoft Windows 98, ME, 2000 or XP. Refer to [Appendix A, USB Hard Disk Drive Preparation](#) for information on preparing the external drive for back up.

Highlight **Clip Copy (MENU ► Config ► Clip Copy)** and then press \leftarrow . The Clip Copy screen displays.

Figure 3-59 Clip Copy Screen

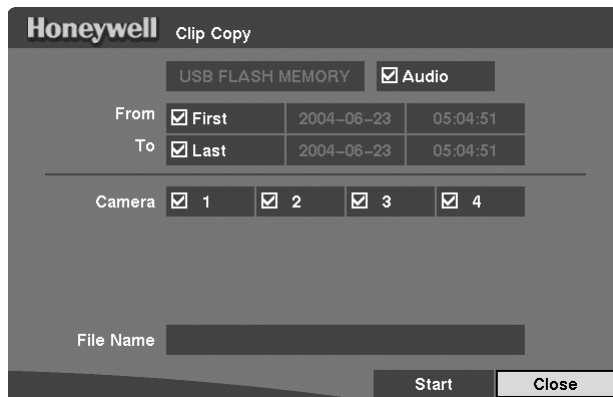

1. To select the type of drive to use for back up, highlight the box on the top and then press \leftarrow . A drop-down list of available drives displays. You can select from **IDE CD-RW, USB Flash Memory, USB HDD, or USB CD-RW**.
2. Place a check mark in the **Audio** box to archive recorded audio with video.
3. You can define how much video to copy by changing the start and end times and dates. You can also select which camera you wish to back up.

4. Highlight the **File Name** box and then press \leftarrow . A virtual keyboard displays (see [Figure 3-7](#)). Enter a file name for the video you are copying and select **Close**. The DVR automatically adds the camera number (for example, 01) and .exe to the file name. If you want to save the file in a specific folder, enter the folder name followed by a / (for example, *folder/filename*).
5. After you have given the video a file name, highlight the **Start** button and then press \leftarrow . The DVR displays the drive capacity, the backup file size, and asks if you want to continue.

When the selected drive has more than two partitions, the following Disk Partition Selection screen displays. If the file system is not FAT32, the Type displays Not Supported.

Figure 3-60 Disk Partition Selection Screen

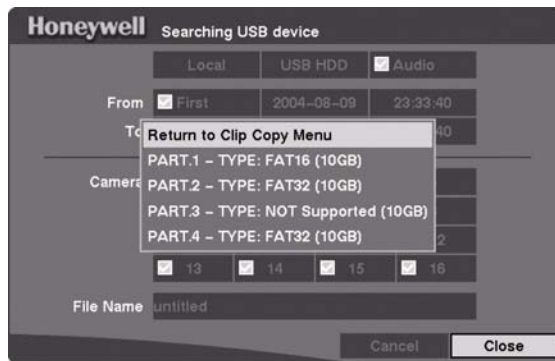

After you select the drive and partition to use for clip copy, the DVR displays the drive capacity, the clip size, and asks if you want to continue.

Note We recommend that you do not copy files larger than 2 GB.

You can use other functions on the DVR while video is being backed up. To do this, highlight **Close** and then press \leftarrow . You can return to the Clip Copy screen at any time to check the progress.

Note You can not end the clip copy process during CD burning.

Refer to the [Remote Administration System \(RAS\) User Guide](#) for instructions on how to review the images you have copied.

Note During clip copy, you cannot change the system date and time, shut the system down, switch to the Quick Setup mode, clear all data, or change the system setup from a remote site.

Note The recording speed decreases to 1 ips per camera during CD burning or while the DVR is preparing clip copy data on the hard disk drive.

Caution Do **not** use poor quality CD-R or CD-RW discs or ones that have been scratched or damaged in any way.

Caution Do **not** disconnect the USB cable or the power from the external drive while copying video clips. If the external drive is shut down or the USB cable is disconnected while copying video clips, **the DVR system may not work normally or the external drive could be damaged**, and you will get an error message the next time you try to copy. You will need to power down the DVR and restart it to get rid of the error message. After the file system of the USB-IDE hard disk drive has been corrupted, this error message cannot be dismissed. Even after restarting the DVR it may automatically restart while preparing a backup. You must recover the file system using the recovery program, or you must reformat the hard disk drive.

Load Default Setup

Highlighting and selecting **Load Default Setup (MENU ► Config ► Load Default Setup)** brings up a screen asking you if you really want to load default settings and confirm it with a password.

Note Loading the Default Setup will not change the current time, time zone, daylight saving time, or network settings.

Load / Save Setup

You can load saved DVR settings or save the current DVR settings. To load the saved settings:

1. Connect the USB device containing the setup file (**.cfg**) to the DVR.
2. Highlight **Load — File Name** and press **↵**. The Load Setup screen displays setup file names that are available.
3. Select the desired setup file and press **OK**. The selected file name is displayed in the **File Name** field.
4. Select **Load** to load the selected saved settings and change the DVR settings accordingly.

Note Even after changing the DVR settings by loading saved settings, the time-related settings (Date/Time, Time Zone and Daylight Saving Time) will NOT be changed.

Note If you want to change the network settings, check **Include network setup**. Otherwise, the network settings will NOT be changed.

To save the current settings:

1. Connect the USB device to the DVR.
2. Highlight **Save — File Name** and press **↵**. A virtual keyboard allows you to enter the file name.
3. Selecting **Save** will save the current DVR settings in .cfg file format on the USB device.

Figure 3-61 Load / Save Setup Screen

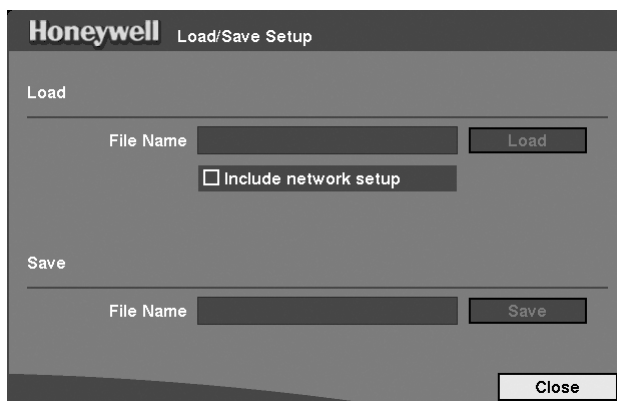

Clear All Data

Highlighting and selecting **Clear All Data** (MENU ► Config ► **Clear All Data**) brings up a screen asking you if you really want to clear all data and to confirm it with a password.

Caution Selecting **Clear All Data** will erase all recorded video.

Operation

This chapter covers the following topics:

- Live monitoring
- Recording video
- Recording audio
- Playing recorded video
- Searching for video by date/time, calendar, and events

Note This chapter assumes you have correctly installed and configured your DVR. If you have not, please see *Chapter 2* for installation and *Chapter 3* for configuration.

The DVR controls are similar to a VCR. As with a VCR, the main functions are recording and playing back video. However, you have much greater control over recording and playing back video. You can:

- Establish recording schedules based on time of day and day of the week
- Search through the recorded video using much more sophisticated tools than those available with VCRs

Features of your DVR that are not available with traditional VCRs are:

- View video remotely
- Record video at the same time you are watching previously recorded video

The DVR operates even when no hard disk drives are installed. In this case, recording, playback, and any processes that access hard disk drives, are not supported. You can only view live video and establish system settings that are not related to hard disk drive operation. Also, the unit can be connected with RAS Watch either via Ethernet or modem.

Figure 4-1 DVR Front Panel

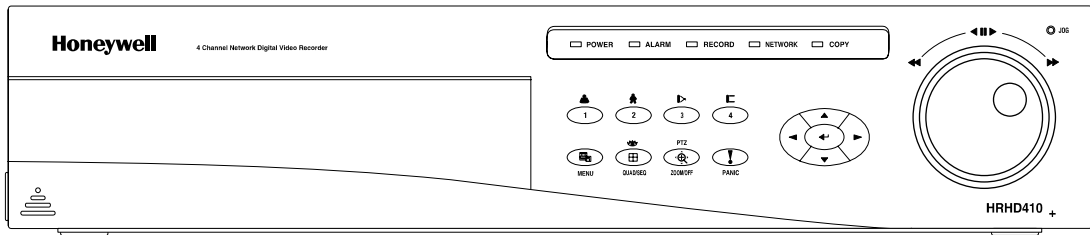

The front panel controls are described in *Chapter 3, Configuration*.

Turning on the Power

After you have installed the DVR following the instructions in *Chapter 2, Installation*, it is ready to record. The unit takes approximately 60 seconds to initialize.

The DVR recovers automatically after the unit is initialized if recorded data on the storage device has been damaged.

Live Monitoring

As soon as the DVR completes its initialization process, it will begin showing live video on the attached monitor and playing live audio through the attached speaker. The default mode is to display all four cameras at the same time. Pressing any camera button causes that camera to display full screen. It displays live video and plays live audio until the user enters another mode.

Press **QUAD/SEQ** to toggle between quad (2x2) display mode and sequence mode. Press **ENTER** in Live Monitoring mode to freeze the current image on the screen until you press the ENTER button again. The screen displays *.

You can set the DVR to display the event-detected video in full-screen on the monitor during the preset dwell time when there is an Event. The video of the lowest camera number among cameras associated with the event-detected sensor displays and the DVR returns to the previous screen format after event monitoring dwell time. While the event monitoring is activated, the monitoring for all other subsequent events is ignored. Pressing any individual camera button or **QUAD/SEQ** during event monitoring releases the current event monitoring and displays the selected camera or returns to the previous screen format.

The DVR displays the text-in data if there is any text input during live monitoring. The text-in information displays on the image.

Note The text-in displays only in full screen.

Figure 4-2 Live Monitoring (Text-In) Screen



PTZ Mode

The DVR controls cameras with Pan, Tilt and Zoom capabilities. Press **PTZ** to enter the PTZ mode. You can control the camera using front panel control buttons or by setting up presets.

Control buttons	Function
Left and Right arrows	Pan left and right
Up and Down arrows	Tilt the camera up and down
Camera 1	Zoom in
Camera 2	Zoom out
Camera 3, Camera 4	Focus the image

Note When the DVR is in PTZ mode, a white line displays around the image.

Note You cannot enter PTZ mode when the DVR detects video loss on the selected camera or the camera is turned off or set up as Covert 1 or Covert 2.

Press **MENU** in PTZ mode to display the PTZ Mode screen. Set the feature you wish to control by selecting it from the menu. Refer to the camera manufacturer's instructions for the proper settings. Depending on the camera specifications, some features may not be supported.

Figure 4-3 PTZ Menu Screen

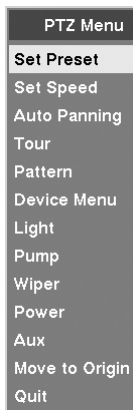

- Press **Set Preset** to configure the presets for PTZ cameras.
- Press **Quit** to close the menu.

Setting PTZ Presets

After you have the camera at the desired installation settings, you can save camera position settings as Presets so that you can go directly to desired views.

1. Select **Set Preset** in the PTZ Menu.
2. Select the number you want to assign to the preset, and then press **↵**. Use the Virtual Keyboard to enter the preset name.
3. Press **↵** to save the preset.

Figure 4-4 PTZ Preset Screen

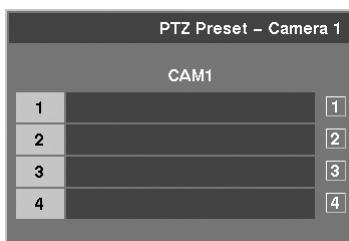

Preset View

After you have set the camera presets, you can go directly to the desired views.

1. Press **QUAD/SEQ** to load the Preset View dialog box.
2. Select the desired preset number to load the preset.

Figure 4-5 Preset View Screen

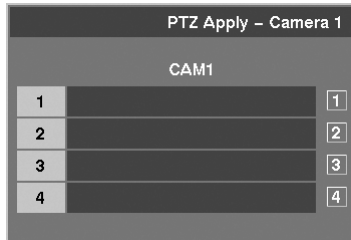

Digital Zoom Mode

You can enter Digital Zoom mode by pressing the **PTZ** button on the front panel while in PTZ mode.

Note You cannot enter Digital Zoom mode when the DVR detects video loss on the selected camera or the camera is turned off or set up as Covert 1 or Covert 2.

After you are in Digital Zoom mode, a bright small box is laid over the image. The box indicates the spot to be enlarged. To enlarge the spot, move the position of that box using the Arrow buttons, and then press **↵**. The enlarged screen displays **ⓧ**. Pressing **PTZ** again returns the DVR to Live Monitoring mode.

Recording Video

After you have installed the DVR following the instructions in *Chapter 2, Installation*, it is ready to record. Unless you change the setup, the DVR continues to record until the hard disk drive is full. The factory default is **Stop** when the hard disk drive is full. The DVR can be set to continue recording (**Overwrite**) after the hard disk drive is full. It does this by recording over the oldest video.

Although you will be able to record without changing the unit from its original factory settings, you will want to take advantages of the DVR's many tools. See *Chapter 3, Configuration* for detailed descriptions of the recording mode options.

Note When the DVR is recording video, the REC LED on the front panel is lit and a red dot appears on the monitor.

Although you have set time-lapse or event recording, pressing the **PANIC** button activates panic recording, so the DVR will record video regardless of the time-lapse or event recording schedule. Press **PANIC** again to release the panic recording.

Note When the DVR is in Panic Recording mode, a white ! appears in the red dot, indicating the DVR is recording, and the REC LED on the front panel flickers.

Recording Audio

If the DVR was set up to record audio, it will record audio when video is recording.

Note Make certain you comply with all local and federal laws and regulations when recording audio.

Playing Recorded Video

After video has been recorded, you can view it using the Arrow buttons. When playing video for the first time, the DVR displays the most recent image. When playing video subsequent times, the DVR starts playing video from the last recalled image.

When playing video, the DVR displays the text-in data if there is any text input. The text-in information displays on the image.

Note The text-in displays only in full screen.

Note Make sure that Text-In is turned **On** during OSD setup if you want to display the text-in information on the playback image (see *OSD (On-Screen Display) Setup*, page 58).

Figure 4-6 Playback (Text-In) Screen



Playback Controls

Table 4-1 Playback Controls

















Press this button ...	To do this ...
Left Arrow 	Play video backward at high speed. Pressing the button again toggles the playback speed from  ,  , and  . The screen displays  ,  , and  respectively. Note Entering Fast Backward Playback mode from Live Monitoring mode can be password protected.
Right Arrow 	Play video forward at high speed. Pressing the button again toggles the playback speed from  ,  , and  . The screen displays  ,  , and  respectively.
	After selecting ENTER/PAUSE , press the Up arrow to advance to the next image.
	After selecting ENTER/PAUSE , press the Down arrow to review the previous image.

Table 4-1 Playback Controls (cont'd)

Press this button ...	To do this ...
ENTER/PAUSE	Pause the video on the screen. The screen displays
Camera Buttons 1 to 4	Display that camera at full screen.
QUAD/SEQ	<p>Change the display format from full screen to quad (2x2) mode.</p> <p>Note Changing the display format from quad (2x2) to full screen is not available.</p> <p>Note When playing recorded video at maximum speed with very high image quality, playback of recorded audio may be occasionally interrupted.</p>
Shuttle Ring	<p>The Shuttle Ring only functions in Playback mode. Turn the ring clockwise to play video forward. Turn the ring counterclockwise to play video backward. Playback speed varies with the amount the ring is turned. The playback speeds are ◀x0.5, ◀◀, ◀◀◀, and ◀◀◀◀, ▶x0.5, ▶, ▶▶, ▶▶▶, and ▶▶▶▶.</p> <p>When you release the ring, it snaps back to the center position and the video pauses.</p>
Jog Dial	<p>The Jog Dial only functions when playback video has been paused. Turn the jog dial clockwise to play video forward image-by-image. Turn the jog dial counterclockwise to play video backward image-by-image.</p> <p>Note When playing recorded video at maximum speed with very high image quality, playback of recorded audio may be interrupted occasionally.</p> <p>Note You cannot change the system setup from a remote site during Playback mode.</p>

Digital Zoom Playback Mode

Press the **PTZ** button while in Playback mode to enter Digital Zoom Playback mode. The image pauses and a bright small box is laid over the image. This box indicates the spot to be enlarged. To enlarge that spot, move the position of the box using the Arrow buttons, and then press ↵. The enlarged screen displays Ⓢ. Press **PTZ** again to release the Digital Zoom Playback mode and return to Playback mode.

Note You cannot enter Digital Zoom Playback mode when the selected camera is set up as Cover 1 or Covert 2 and not played back.

Figure 4-7 Digital Zoom Screen



Searching Video

Press **MENU** while in Playback mode to display the Search Menu.

Figure 4-8 Search Menu

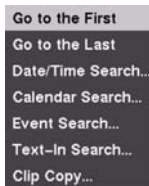

Option	Function
Go to First	Displays the first recorded image
Go to Last	Displays the last recorded image
Date/Time Search...	Searches by date and time (see <i>Date/Time Search</i> for more details)
Calendar Search...	Searches using a calendar (see <i>Calendar Search</i> for more details)
Event Search...	Selects video from the event log (see <i>Event Search</i> for more details)
Text-In Search...	Searches text input strings (see <i>Text-In Search</i> for more details)
Clip Copy...	Clips a video segment and saves it

Date/Time Search

Figure 4-9 Date/Time Search Screen

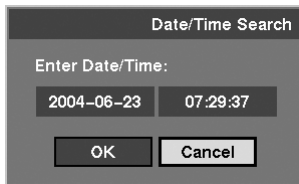

1. Move the cursor over the date and then press \leftarrow .
You can use the Arrow buttons or the Jog Dial to adjust the numbers.
2. Move the cursor over the time and then press \leftarrow .
You can use the Arrow buttons or the Jog Dial to adjust the numbers.
3. After you have set the date and time you want to search, highlight **OK** and then press \leftarrow . The selected date and time displays. (If no video was recorded at the selected time, you will see a blank screen.)
4. You can now use the Arrow buttons, Jog Dial, and Shuttle Ring controls to review the surrounding video.

Calendar Search

Figure 4-10 Calendar Search Screen



1. Days with recorded video display on the calendar with white numbers. You can highlight the days with recorded video by using the Arrow buttons. After you have highlighted a day, press \leftarrow to select it.
2. A time bar displays at the bottom of the calendar. Hours in which video was recorded will be highlighted with blue. Highlight the time bar and select the time using the left and right Arrow buttons. Time adjusts in 30 minute increments.
3. After you have set the date and time you want to search, highlight **Go** and then press \leftarrow . The selected date and time displays.

4. You can now use the Arrow buttons, Jog Dial, and Shuttle Ring controls to review the surrounding video.

Event Search

The DVR maintains a log of each time the Alarm Input port is activated. The Event Search screen displays this list.

Figure 4-11 Event Log Screen

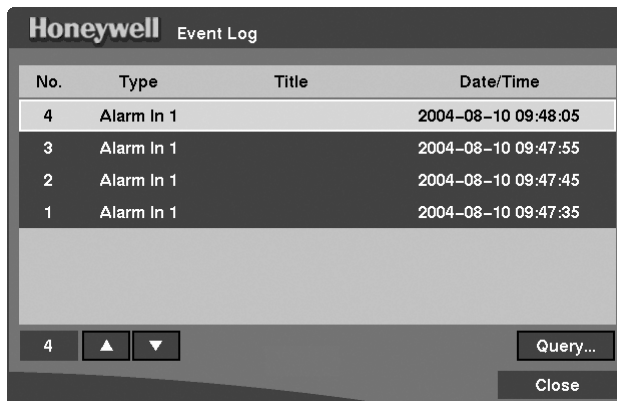

1. Use the Arrow buttons to highlight the event for which you would like to see video.
2. Press \leftarrow to extract the event video and display the first image of the event.
3. Press the Arrow buttons to start playing the event video segment.
Press **ENTER/PAUSE** to pause the video. Press again to return to live monitoring.

You can also narrow your event search by selecting **Query...** and setting up the new search condition.

Figure 4-12 Event Search (by Event) Screen



Figure 4-13 Event Search (by Camera) Screen



1. Highlight the box beside **Search by** and then press \leftarrow to toggle between Event and Camera.
2. You can search video from the first to last recorded images, or you can set the start and stop times and dates.

When you select **Search by Camera**, select the target cameras and event options.

When you select **Search by Event**, select event options for each device.

3. After you set your desired search conditions, highlight **Find** and then press \leftarrow to display the search results in the Event Log screen. Select **Cancel** to exit the screen without saving the changes.

Text-In Search

The DVR maintains a log of each time there is text input. The Text-In Log screen displays this list.

Figure 4-14 Text-In Log Screen

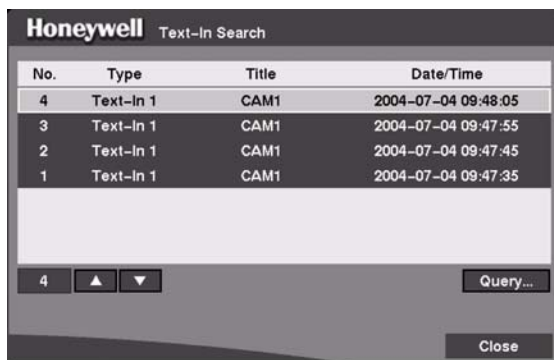

1. Highlight the event for which you would like to see video.
2. Press \leftarrow to extract the event video and display the first image of the event.

3. Press the arrow button to start playing the "text-in" video segment with the text-in data on the image.
4. Press **ENTER/PAUSE** to pause the video. Press **ENTER/PAUSE** again to return to live monitoring.

You can also narrow your event search by selecting the **Query...** button and setting up the new search condition.

Figure 4-15 Text-In Search Screen

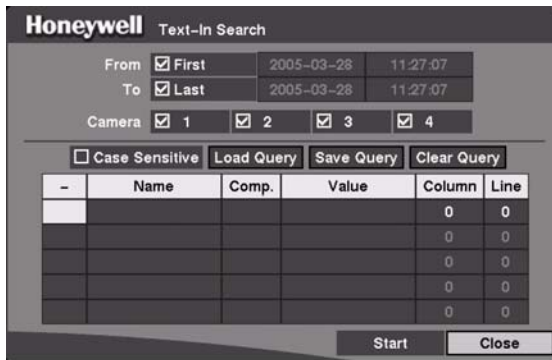

You can search video from the first to last recorded images, or you can set the start and stop times and dates.

1. Select the target cameras to search text-in data.
2. Highlight the **Case Sensitive** box and press \leftarrow to toggle between **On** and **Off**. If the Case Sensitive box is turned **On**, the DVR distinguishes between upper and lower case letters.
3. Highlight the **Load Query** box and press \leftarrow to load the saved Query settings.
4. Highlight the **Save Query** box and press \leftarrow to save the current Query settings. Enter the title for the current Query option using the virtual keyboard.
5. Highlight the **Clear Query** box and press \leftarrow to delete the current Query settings.
6. Highlight the **Name** box and enter the text to search using the virtual keyboard.
7. Highlight the **Comp.** box and enter the comparison operator using the virtual keyboard.
8. Highlight the **Value** box and enter the comparison value using the virtual keyboard.

Note The Column and Line can be used for more specific search of the text-in data. **Column** indicates the location of each individual category, and **Line** indicates the line where the category is located. Change the number of Column and Line by highlighting it and using the Up and Down arrow buttons to increase and decrease the number.

Operation

9. Enter **AND** or **OR** in the box under – heading for more specific text-in data search.
10. After you set your desired search conditions, highlight **Start** and then press ↵ to display the search results in the Text-In Log screen. Select **Close** to exit this screen and return to the previous screen.

USB Hard Disk Drive Preparation

This appendix covers how to prepare the USB-IDE hard disk drive for computers using either Windows 2000 or Windows 98 operating systems.

Preparing the USB-IDE Hard Disk Drive In Windows 2000

Note Preparing a USB-IDE hard disk drive under Windows XP is almost identical to Windows 2000.

1. Connect the USB-IDE hard disk drive to your computer using the USB cable.
2. Turn on your computer.
3. The USB device icon should display on the Taskbar.
4. If the USB-IDE hard disk drive is partitioned or has data, it will show up in **My Computer** as a hard disk drive icon. Check the file system by right clicking on the icon and checking under **Properties** ► **General** ► **File System**. If the file system is **not** FAT32 format, format the USB-IDE hard disk drive using the FAT32 format.
5. If the USB-IDE hard disk drive is not partitioned, go to **Administrative Tools** in **Control Panel** and start **Computer Management**. Open **Disk Management** in **Storage** and right click an unallocated region of the USB-IDE hard disk drive. Then, click **Create Partition**.
6. In the **Create Partition** wizard, click **Next**, then **Primary Partition**, and follow the instructions on the screen. Make sure that FAT32 is selected for the file system.

Note The partition size should be less than 32 GB because of Windows operating system limitations.

After formatting is complete, the USB-IDE hard disk drive will be added to **My Computer**.

7. Connect the USB-IDE hard disk drive to the DVR.

Preparing the USB-IDE Hard Disk Drive In Windows 98

Note Preparing a USB-IDE hard disk drive under Windows ME is almost identical to Windows 98.

1. Connect the USB-IDE hard disk drive to your computer using the USB Cable.
2. Turn on your computer. The Add New Hardware wizard window displays.
3. Install the device driver for the USB backup device following the instructions provided with your USB hard disk drive.
4. If the USB-IDE hard disk drive is partitioned or contains data, it will show up in My Computer as a hard disk drive icon. Check the file system in **Properties** ► **General** ► **File System**. If the file system is **not** FAT32 format, format the USB-IDE hard disk drive with FAT32 format.
5. Run the FDISK utility by clicking **Start** then **Run**. Type **fdisk** and then click **OK**.
6. At the MS-DOS command prompt, type **Y** and click ↵ Enter on the keyboard.
7. In the **FDISK Option** menu, select **5. Change current fixed disk drive**.
8. Select the appropriate letter corresponding to the USB-IDE hard disk drive.
9. In the **FDISK Option** menu, select **1. Create DOS partition or Logical DOS Drive**.
10. In the **Create DOS Partition** or **Logical DOS Drive** menu, select **1. Create Primary DOS Partition**. Type **Y** to use all available space and click ↵ (enter). Click **ESC** to exit the screen after the USB-IDE hard disk drive partition is created.
11. Restart your computer and verify the newly created drive is in **My Computer**.
12. Right click the newly created hard disk drive icon and select **Format**.
13. In the Format Screen, select **Full** as the **Format type** and click **Start**.
14. After formatting is complete, connect the USB-IDE hard disk drive to the DVR.

Text-In Query Examples

This appendix provides two samples of Text-In Query searches.

Text-In Query Example 1

```

      1           2           3           4           5           6
1234567890 1234567890 1234567890 1234567890 1234567890 1234567890
      Item           Unit price           Qty           amount
=====
Coke           | $    2.20 |           1(s) | $    2.20
Fanta          | $    2.20 |           1(s) | $    2.20
Hotdog         | $    3.50 |           3(s) | $   10.50
Pepsi          | $    1.95 |           1(s) | $    1.95
=====
                                total : $    16.85

Thank you~~
    
```

In the above text-in data, notice that the comparison value is located at 17th (Unit price, \$ mark will be ignored automatically), 28th (Qty) and 40th (amount) characters (including spaces) from the left. In this case, you can enter “17”, “28” and “40” in each Column box.

For example, if you want to search for Coke with a Qty (Quantity) of more than 1 and Hotdog with an amount totaling over \$8, the following search condition can be set.

Figure B-1 Text-In Search Condition Example 1

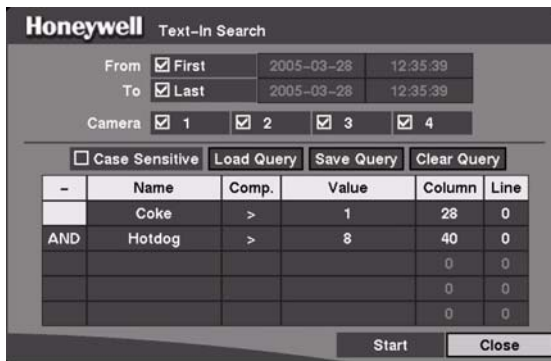

Text-In Query Example 2

```

          1          2          3          4          5          6
123456789012345678901234567890123456789012345678901234567890
      Item          Unit price          Qty          amount
=====
Coke          | $    2.20 |          1(s) | $    2.20
Fanta        | $    2.20 |          1(s) | $    2.20
Hotdog       | $    3.50 |          3(s) | $   10.50
Pepsi       | $    1.95 |          1(s) | $    1.95
=====
                                total : $    16.85
    
```

Thank you~~

In the above text-in data, you can find that the comparison value is located at 17th (Unit price, \$ mark will be ignored automatically), 28th (Qty) and 40th (amount) characters (including spaces) from the left, but the value of amount category is located on a different line from Item. In this case, you can enter "17", "28" and "40" in each Column box and enter "1" in the Line box for the next line.

For example, if you want to search for Coke with a Qty (Quantity) of more than 1 and Hotdog with an amount totaling over \$8, the following search condition can be set.

Figure B-2 Text-In Search Condition Example 2

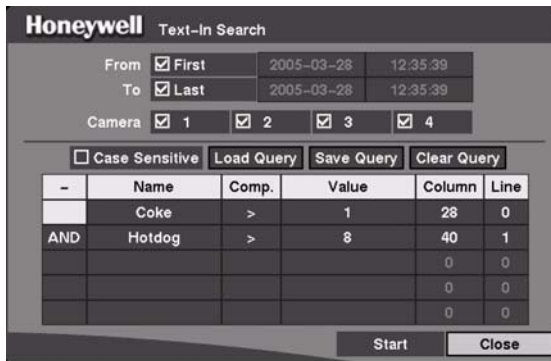

Solutions

This appendix provides solutions to common technical issues.

Problem	Possible solution
No power	<ul style="list-style-type: none"> • Check power cord connections. • Confirm that there is power at the outlet.
No live video	<ul style="list-style-type: none"> • Check camera video cable and connections. • Check monitor video cable and connections. • Confirm that the camera has power. • Check camera lens settings. • Check CVBS(SVHS)/VGA switch settings.
Live video extremely bright	If a cable is attached to the "Loop" connector, make certain it is connected to a properly terminated device.
DVR stops recording	If the hard disk drive is full, you need to either delete video or set the DVR to the Overwrite Mode.
DVR displays an error message that the last recorded image date and time is later than the current date and time setting of the DVR	<p>The DVR automatically resets the time and date of the unit, according to the time and date of the last recorded image.</p> <p>If this is not the correct time and date, reset the time and date manually.</p> <p>If the correct time and date is earlier than the last recorded image, any video with a later time and date will be lost when resetting the correct time and date.</p>

Connector Pinouts

I/O Connector Pinouts

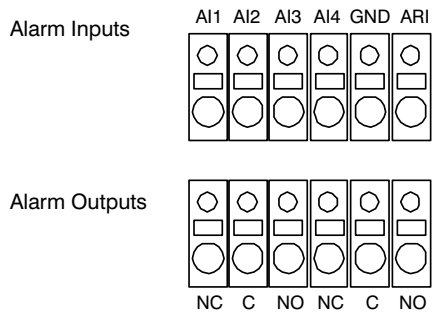

AI (1 to 4)	Alarm Inputs 1 to 4
GND	Chassis Ground
ARI	Alarm Reset In
NC	Normally Closed
C	Common
NO	Normally Open

RS485 Connector Pinouts

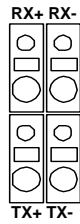

Master unit		Slave unit
RX-/TX-	to	TX-/RX-
RX+/TX+	to	TX+/RX+

Map of Screens

Figure E-1 Screen Map

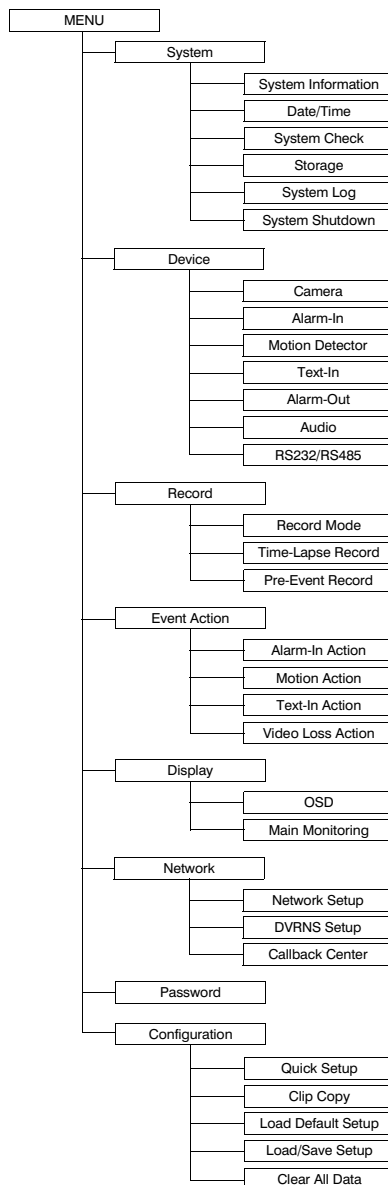

Map of Screens

Specifications

Table F-1 Technical Specifications

Video	
Signal Format:	NTSC or PAL (auto detect)
Video Input:	Composite: 4 looping inputs, 1 Vp-p, auto-terminating, 75 Ohms
Monitor Outputs:	Composite: One (BNC), 1 Vp-p, 75 Ohms, SVHS: One (Y/C), Analog RGB: One (VGA) - NTSC: 30.8 kHz (horizontal frequency)/60 Hz (vertical frequency) - PAL: 30.8 kHz (horizontal frequency)/50 Hz (vertical frequency)
Video Resolution:	720 x 480 (NTSC) 720 x 576 (PAL)
Playback/Record Speed (images per second):	<u>Standard Resolution:</u> 120 ips (NTSC), 100 ips (PAL) <u>High Resolution:</u> 60 ips (NTSC), 50 ips (PAL)
Inputs/Outputs	
Alarm Input:	4 TTL, programmable as NC/NO, 4.3V threshold
Alarm Output:	2 relay out, terminal block, NC & NO, 0.5A @ 125VAC, 1A @ 30VDC
Alarm Reset Input:	1 TTL, terminal block
Internal Buzzer:	80 db at 10 cm
Network Connectivity:	10/100 Base Ethernet, RS232C for external modem
Audio Input:	4 lines in
Audio Output:	1 line out

Table F-1 Technical Specifications**Connectors**

Video Input:	Composite: 4 BNC
Video Loop:	Composite: 4 BNC
Monitor Output	Composite: 1 BNC SVHS: 1 Y/C ^a Analog RGB: 1 (VGA)
Audio In:	4 RCA connectors
Audio Out:	1 RCA connector
Alarms:	Terminal block
Alarm Reset In:	Terminal block
Ethernet Port:	RJ45
RS232C Serial Port:	DB9 (P)
RS485 Serial Port:	4 connector terminal block
USB Port:	1 on front panel (1.1)

Storage

Primary Storage:	EIDE hard disk drive (up to 3)
Backup Storage:	Built-in Internal CD-RW Drive, USB Hard disk drive, USB CD-RW drive or USB Flash Drive

General

Dimensions: (W x H x D)	16.9 in. x 3.5 in. x 14 in. (430 mm x 88 mm x 355 mm)
Unit Weight:	17.64 lb. (8.0 kg)
Shipping Weight:	22.44 lb. (10.2 kg)
Shipping Dimensions: (W x H x D)	21.3 in. x 10.2 in. x 19.7 in. (540 mm x 260 mm x 500 mm)
Operating Temperature:	41°F ~ 104°F (5°C ~ 40°C)
Operating Humidity:	0% ~ 90%
Power:	115 to 230 V~, 2 A, 50/60 Hz

Approval

Approvals:	FCC, CE, CB, UL
------------	-----------------

Note Specifications subject to change without notice.

^a Using a shielded S-Video cable provides better quality video display and reduces image noise.

Index

A

- Admin Password screen [21](#)
- Alarm In Event Action (Alarm Out) screen [50](#)
- Alarm In Event Action (Notify) Setup screen [51](#)
- Alarm In Event Action screen [49](#)
- Alarm In screen [36](#)
- alarm in, setting [35](#)
- Alarm Out Schedule screen [41](#)
- Alarm Out screen [40](#)
- alarm out, setting [40](#)
- alarms, connecting [12](#)
- Audio [42](#)
- audio
 - connecting [7](#)
 - recording [82](#)
 - setting [41](#)
 - setting recording [21](#)
- Audio Setup screen [42](#)

C

- Calendar Search screen [86](#)
- callback center
 - LAN setup [68](#)
 - Modem setup [69](#)
- Callback Center (LAN) Setup screen [68](#)
- Camera Setup screen [34](#)
- cameras
 - assigning IDs [35](#)
 - assigning titles [35](#)
 - controllable (PTZ) [35](#)
 - main monitor setup [59](#)
 - sequence dwell time [59](#)
 - setting [34](#)
- clear all data [76](#)
- Clip Copy screen [72](#)
- clip copy, setting [72](#)
- clips, searching [85–88](#)
- Config Menu [72](#)

- connections
 - alarm [12](#)
 - audio [7](#)
 - monitor [9](#)
 - network port [10](#)
 - power cord [14](#)
 - RS485 [13](#)
 - USB port [14](#)
 - video [6](#)

D

- data, clearing all [76](#)
- Date/Time screen [26](#)
- Date/Time Search screen [86](#)
- date/time, setting [26](#)
- default settings, loading [74](#)
- Device menu [34](#)
- device status [31](#)
- Digital Zoom screen [85](#)
- Disk Partition Selection screen [73](#)
- DVRNS Setup screen [66](#)

E

- erase all data [76](#)
- Event Log screen [87](#)
- Event Search (by Camera) screen [88](#)
- Event Search (by Event) screen [87](#)
- event setup [49](#)
- events
 - setting alarm in [49](#)
 - setting alarm notify [51](#)
 - setting alarm out [50](#)
 - setting motion detector alarm out [52](#)
 - setting motion detector notify remote site [53](#)
 - setting motion detector record [51](#)
- external modem, setting [43](#)

F

factory reset [14](#)
fault conditions, viewing [31](#)
features [1](#)
front panel controls [17–20](#)

H

Holiday Setup screen [27](#)

I

I/O connector pinouts [99](#)
initial setup [20](#)
input devices, configuring [34](#)
installation [5–15](#)
 typical [2](#)

L

LAN (ADSL) Setup screen [64](#)
LAN (DHCP) Setup screen [64](#)
LAN setup [60](#)
LAN Setup screen [61](#)
LAN, setting [61](#)
language, selecting [24](#)
live monitoring [78](#)
Live Monitoring (Text-In) screen [79](#)

M

main monitor, setting [59](#)
Main Monitoring Setup screen [59](#)
menus
 Config [72](#)
 Device [34](#)
 Search [85](#)
Modem Setup screen [65](#)
modem, setting [65](#)
modes, PTZ [79](#)
monitor, connecting [9](#)
Motion Detection Zone screen [37](#)
Motion Detector Event Action (Alarm Out) screen [52](#)
Motion Detector Event Action (Notify) screen [53](#)
Motion Detector Event Action (Record) Setup screen [51](#)
Motion Detector screen [36, 38](#)
motion detector, setting [36](#)
motion sensitivity, setting [36](#)

N

network port, connecting [10](#)
Network Setup screen [60](#)
network, setting [60](#)

normal setup [23](#)
Normal Setup screen [23](#)

O

overview, technical [2](#)

P

Password Setup screen [70](#)
passwords, setting [70](#)
pinouts
 I/O connector [99](#)
 RS485 connector [100](#)
Playback (Text-In) screen [83](#)
Port Number Setup screen [62](#)
power cord, connecting [14](#)
power, turning on [20](#)
pre-event recording, setting [48](#)
Preset View screen [81](#)
problem solving [93, 97](#)
PTZ cameras, selecting [35](#)
PTZ control, setting [43](#)
PTZ Menu screen [80](#)
PTZ mode [79](#)
PTZ Preset screen [80](#)

Q

quick setup [21](#)
Quick Setup screen [21](#)

R

rear panel [6](#)
Record Mode Setup screen [44](#)
record mode, setting [44](#)
recording
 pre-event setup [48](#)
 timelapse setup [46](#)
recording quality, setting [21](#)
recording speed, setting [21](#)
remote control, setting [43](#)
RS232, setting [42](#)
RS232/RS485 screen [43](#)
RS485 connector pinouts [100](#)
RS485, connecting [13](#)
RS485, setting [42](#)

S

S.M.A.R.T. Alert screen [32](#)
S.M.A.R.T. setup [32](#)
safety precautions [xiv–xvi](#)
screen map [101](#)

screens

- Admin Password [21](#)
- Alarm In [36](#)
- Alarm In Event Action [49](#)
- Alarm In Event Action (Alarm Out) [50](#)
- Alarm In Event Action (Notify) Setup [51](#)
- Alarm Out [40](#)
- Alarm Out Schedule [41](#)
- Audio Setup [42](#)
- Calendar Search [86](#)
- Callback Center (LAN) Setup [68](#)
- Camera Setup [34](#)
- Clip Copy [72](#)
- Date/Time [26](#)
- Date/Time Search [86](#)
- Digital Zoom [85](#)
- Disk Partition Selection [73](#)
- DVRNS Setup [66](#)
- Event Log [87](#)
- Event Search (by Camera) [88](#)
- Event Search (by Event) [87](#)
- Holiday Setup [27](#)
- LAN (ADSL) Setup [64](#)
- LAN (DHCP) Setup [64](#)
- LAN Setup [61](#)
- Live Monitoring (Text-In) [79](#)
- Main Monitoring Setup [59](#)
- Modem Setup [65](#)
- Motion Detection Zone [37](#)
- Motion Detector [36, 38](#)
- Motion Detector Event Action (Alarm Out) [52](#)
- Motion Detector Event Action (Notify) [53](#)
- Motion Detector Event Action (Record) Setup [51](#)
- Network Setup [60](#)
- Normal Setup [23](#)
- Password Setup [70](#)
- Playback (Text-In) [83](#)
- Port Number Setup [62](#)
- Preset View [81](#)
- PTZ Menu [80](#)
- PTZ Preset [80](#)
- Quick Setup [21](#)
- Record Mode Setup [44](#)
- RS232/RS485 [43](#)
- S.M.A.R.T. Alert [32](#)
- Storage [31](#)
- System Check [29](#)
- System Information [23](#)
- System Log [33](#)
- Text-In (Generic Text) Setup [39](#)
- Text-In Event Action (Alarm Out) [55](#)
- Text-In Event Action (Notify) [55](#)
- Text-In Event Action (Record) [54](#)

- Text-In Log [88](#)
- Text-In Setup [37](#)
- Time Sync [28](#)
- Time-Lapse Record Setup [46](#)
- Time-Lapse Recording Schedule [47](#)
- Video Loss Event Action (Alarm Out) [57](#)
- Video Loss Event Action (Notify) [57](#)
- Video Loss Event Action (Record) [56](#)

screens

- Text-In Search [89](#)

- Search menu [85](#)

- sequence dwell time [22, 59](#)

setup

- alarm in [35](#)

- alarm in events [49](#)

- alarm notify [51](#)

- alarm out [40](#)

- alarm out events [50](#)

- audio [41](#)

- callback center (LAN) [68](#)

- cameras [34](#)

- clip copy [72](#)

- date/time [26](#)

- events [49](#)

- external modem [43](#)

- initial [20](#)

- LAN [60, 61](#)

- loading default [74](#)

- main monitor [59](#)

- modem [65](#)

- motion detector alarm out events [52](#)

- motion detector event record [51](#)

- motion detector notify remote site [53](#)

- network [60](#)

- normal [23](#)

- password [70](#)

- pre-event recording [48](#)

- PTZ control [43](#)

- quick [21](#)

- record mode [44](#)

- remote control [43](#)

- storage [31](#)

- timelapse record mode [46](#)

- timelapse record schedule [47](#)

- video loss alarm [57](#)

- video loss notify remote site [57](#)

- video loss record [56](#)

- solutions [93, 97](#)

- specifications [103](#)

- Storage screen [31](#)

- system check [29](#)

- System Check screen [29](#)

- system information [23](#)

- System Information screen [23](#)

system log [33](#)
System Log screen [33](#)
system shutdown [33](#)

T

technical overview [2](#)
Text-In (Generic Text) Setup screen [39](#)
Text-In Event Action (Alarm Out) screen [55](#)
Text-In Event Action (Notify) screen [55](#)
Text-In Event Action (Record) screen [54](#)
Text-In Log screen [88](#)
Text-In Search screen [89](#)
Text-In Setup screen [37](#)
Time Sync screen [28](#)
time/date, setting [26](#)
Time-Lapse Record Setup screen [46](#)
Time-Lapse Recording Schedule screen [47](#)
timelapse recording, setting schedule [47](#)
timelapse, setting record mode [46](#)
troubleshooting [93](#), [97](#)

U

USB HDD, preparing [91](#)
USB port, connecting [14](#)

V

video
 backing up [72](#)
 connecting [6](#)
 hiding [35](#)
 recording [81](#)
 searching [85–88](#)
video loss
 setting alarm [57](#)
 setting notify remote site [57](#)
Video Loss Event Action (Alarm Out) screen [57](#)
Video Loss Event Action (Notify) screen [57](#)
Video Loss Event Action (Record) screen [56](#)
video loss, setting recording [56](#)

Honeywell Video Systems (Head Office)

2700 Blankenbaker Pkwy, Suite 150
Louisville, KY 40299, USA
www.honeywellvideo.com
☎ +1.800.796.2288

Honeywell Security Australia Pty Ltd.

Unit 5, Riverside Centre, 24-28 River Road West
Parramatta, NSW 2150, Australia
www.ademco.com.au
☎ +61.2.8837.9300

Honeywell Security Asia Pacific

33/F Tower A, City Center, 100 Zun Yi Road
Shanghai 200051, China
www.security.honeywell.com/cn
☎ +86 21.2527.4568

Honeywell Security Asia

Flat A, 16/F, CDW Building, 388 Castle Peak Road
Tsuen Wan, N.T., Hong Kong
www.security.honeywell.com/hk
☎ +852.2405.2323

Honeywell Security France

Parc Gutenberg, 8, Voie La Cardon
91120, Palaiseau, France
www.honeywell.com/security/fr
☎ +33.01.64.53.80.40

Honeywell Security Italia SpA

Via Treviso 2 / 4
31020 San Vendemiano
Treviso, Italy
www.honeywell.com/security/it
☎ +39.04.38.36.51

Honeywell Security España

Mijancas 1. 3^a Planta
P.Ind. Las Mercedes
28022 Madrid, Spain
www.security.honeywell.com/es
☎ +34.902. 667.800

Honeywell Video Systems Northern Europe

Netwerk 121
1446 WV Purmerend, The Netherlands
www.SecurityHouse.nl
☎ +31.299.410.200

Honeywell Video Systems UK Ltd.

Aston Fields Road, Whitehouse Ind Est
Runcorn, Cheshire, WA7 3DL, UK
www.honeywellvideo.com
☎ +0844 8000 235

Honeywell Security South Africa

Unit 6 Galaxy Park, 17 Galaxy Avenue
Linbro Park, P.O. Box 59904
2100 Kengray, Johannesburg, South Africa
www.honeywell.co.za
☎ +27.11.574.2500

Honeywell Security Deutschland

Johannes-Mauthe-Straße 14
D-72458 Albstadt, Germany
www.honeywell.com/security/de
☎ +49.74 31.8 01.0

Honeywell Security Poland

Chmielewskiego 22a, 70-028
Szczecin, Polska
www.ultrak.pl
☎ +48.91.485.40.60

Honeywell Security Czech Republic

Havránkova 33, Brno
Dolní Heršpice, 619 00, Czech Republic
www.olympo.cz
☎ +420.543.558.111

Honeywell Security Slovakia Republic

Vajnorská 142, 83104 Bratislava
Slovakia
www.olympo.sk
☎ +421.2.444.54.660

Honeywell

www.honeywellvideo.com
+1.800.796.CCTV (North America only)
HVSsupport@honeywell.com

© 2007 Honeywell International Inc.

All rights reserved. No part of this publication may be reproduced by any means without written permission from Honeywell Video Systems. The information in this publication is believed to be accurate in all respects. However, Honeywell Video Systems cannot assume responsibility for any consequences resulting from the use thereof. The information contained herein is subject to change without notice. Revisions or new editions to this publication may be issued to incorporate such changes.

Free Manuals Download Website

<http://myh66.com>

<http://usermanuals.us>

<http://www.somanuals.com>

<http://www.4manuals.cc>

<http://www.manual-lib.com>

<http://www.404manual.com>

<http://www.luxmanual.com>

<http://aubethermostatmanual.com>

Golf course search by state

<http://golfingnear.com>

Email search by domain

<http://emailbydomain.com>

Auto manuals search

<http://auto.somanuals.com>

TV manuals search

<http://tv.somanuals.com>