

Dolphin[®] 9700 Mobile Computers

with Windows Mobile[®] 6.5

User's Guide

Disclaimer

Honeywell International Inc. ("HII") reserves the right to make changes in specifications and other information contained in this document without prior notice, and the reader should in all cases consult HII to determine whether any such changes have been made. The information in this publication does not represent a commitment on the part of HII.

HII shall not be liable for technical or editorial errors or omissions contained herein; nor for incidental or consequential damages resulting from the furnishing, performance, or use of this material.

This document contains proprietary information that is protected by copyright. All rights are reserved. No part of this document may be photocopied, reproduced, or translated into another language without the prior written consent of HII.

Web Address: www.honeywellaidc.com

Trademarks

Dolphin, Dolphin RF, HomeBase, Mobile Base, and QuadCharger are trademarks or registered trademarks of Hand Held Products, Inc. or Honeywell International Inc.

Microsoft, Windows, Windows Mobile, Windows CE, Windows 98 Second Edition, Windows NT, Windows 2000, Windows ME, Windows XP, ActiveSync, Outlook, and the Windows logo are trademarks or registered trademarks of Microsoft Corporation.

Other product names mentioned in this manual may be trademarks or registered trademarks of their respective companies and are the property of their respective owners.

The Bluetooth trademarks are owned by Bluetooth SIG, Inc., U.S.A. and licensed to Honeywell.

Patents

For patent information, please refer to www.honeywellaidc.com/patents.

©2010-2011 Honeywell International Inc. All rights reserved.



Table of Contents

Chapter 1 - Agency Information

Laser Safety	1-1
LED Safety	1-2
UL and C-UL Statement.....	1-2
Approvals by Country.....	1-2
R&TTE Compliance Statement—802.11a/b/g, Bluetooth, and/or GSM.....	1-3
Dolphin RF Terminal—802.11a/b/g, Bluetooth, and/or GSM.....	1-3
For European Community Users	1-4
Waste Electrical and Electronic Equipment Information	1-4
Pacemakers, Hearing Aids and Other Electrically Powered Devices	1-5
Hearing AID Compatibility (HAC)	1-5
Informações ANATEL	1-5
China RoHS	1-6

Chapter 2 - Getting Started

Out of the Box	2-1
Today Screen.....	2-4
Navigation Bar	2-4
Icons in the Navigation Bar	2-4
Command Bar.....	2-7
Pop-Up Menus	2-7
Selecting Programs.....	2-7
File Explorer.....	2-8
Search.....	2-9

Chapter 3 - Hardware Overview

Standard Configurations for the 9700	3-1
Peripherals for the 9700.....	3-2
Accessories for the 9700	3-3
Front Panel: 9700	3-4
Front Panel Features for the 9700	3-5
Back Panel: 9700	3-6
Back Panel Features for the 9700.....	3-7
Side Panels: 9700.....	3-8
Left Side	3-8
Right Side	3-8
Installing a Memory Card	3-9
Installing a SIM Card.....	3-9
Bottom Panel: 9700	3-10
I/O Connector.....	3-10
Using the Touch Panel.....	3-10
Installing a Screen Protector	3-11
Healthcare Housing	3-11

Batteries	3-12
Main Battery Pack.....	3-12
Internal Backup Battery	3-13
Managing Battery Power	3-13
Checking Battery Power	3-14
Resetting the Terminal	3-15
Soft Reset (Warm Boot).....	3-15
Hard Reset (Cold Boot)	3-15
Suspend Mode	3-15

Chapter 4 - Using the Scan Image Engine

Overview.....	4-1
Angled Imaging.....	4-1
Image Engine Specifications	4-1
Laser Specifications	4-2
Supported Bar Code Symbolologies	4-2
Decoding	4-3
To Decode a Bar Code.....	4-3
Aiming Options	4-4
Capturing Images	4-5
Taking an Image.....	4-5
Uploading Images.....	4-6

Chapter 5 - Using the Color Camera

Overview.....	5-1
Taking a picture using the Camera Demo tool	5-1
Options	5-2
Taking a picture using the Windows Mobile 6.5 Camera tool.....	5-2
Menu.....	5-3
Options	5-3
Recording Video.....	5-3

Chapter 6 - Using the Keyboards

Available Keyboards.....	6-1
Keyboard Combinations	6-1
Common Buttons.....	6-1
Using the Function Keys.....	6-2
Using the Modifier Keys	6-3
Using the Navigation Keys	6-3
31-Key Numeric Keyboard	6-4
31-Key Keyboard Combinations.....	6-4
45-Key QWERTY Keyboard.....	6-6
45-Key Keyboard Combinations.....	6-6

Chapter 7 - System Settings

Overview.....	7-1
Clock & Alarms	7-2

Personal Menu	7-3
Buttons.....	7-4
Input.....	7-5
System Menu.....	7-7
About	7-8
Backlight	7-9
Certificates.....	7-10
Encryption.....	7-10
Error Reporting	7-10
External GPS	7-11
Managed Programs	7-11
Memory.....	7-12
RIL	7-13
Power.....	7-14
Regional Settings.....	7-14
Remove Programs.....	7-14
Screen	7-16
Task Manager.....	7-17

Chapter 8 - Communication

Connections Menu.....	8-1
Using the IrDA Port.....	8-2
IrDA Port Location	8-2
Sending Data	8-2
Receiving Data	8-3
Connections Manager	8-4
To Access the Connections Manager.....	8-4
Task Tab.....	8-4
Advanced Tab.....	8-5
Dolphin Wireless Manager	8-5
Dolphin Wireless Manager Window.....	8-6
Enabling the Radios.....	8-6
Accessing Radio Configuration Utilities	8-7
ActiveSync Communication.....	8-8
Installing Additional Software	8-10
Adding Programs to the Terminal Using ActiveSync.....	8-10
Adding Programs Directly from the Internet.....	8-11
9700 COM Port Assignment Table.....	8-11

Chapter 9 - Working with GSM/HSDPA/UMTS/GPRS/EDGE

Overview.....	9-1
Penta Band Antenna.....	9-1
SIM Card Installation	9-2
Installing a SIM Card	9-3
Enabling the GSM Radio	9-4

Voice Communication.....	9-4
Audio Modes.....	9-4
Volume Control.....	9-5
Accessing the Dialer Window	9-5
Dialing.....	9-5
Sending Calls.....	9-6
Ending Calls.....	9-6
Keyboard Combinations for Calls	9-6
Accessing Voice Mail.....	9-6
View Options.....	9-6
Setup Options.....	9-7
Data Communication	9-8
Establishing Data Communication.....	9-8
Ending the Data Connection.....	9-10
Manual Network Selection.....	9-11

Chapter 10 - Working with the Bluetooth Radio

Enabling the Bluetooth Radio	10-1
Connecting to Other Bluetooth Devices	10-2
Pairing and Trusted Devices	10-4
Types of Devices and Services	10-5
Connecting to Bluetooth Printers.....	10-6
Connecting to Bluetooth Headsets	10-6
Transferring Files.....	10-7
Making the Terminal Discoverable	10-8
Selecting COM Ports	10-8

Chapter 11 - Working with GPS

Overview.....	11-1
Assisted GPS Support.....	11-1
Powering the GPS Module	11-1
Communication Ports	11-1
Selecting the Port	11-1
COM7	11-2
GPS Intermediate Driver.....	11-2
GPS Demo	11-2

Chapter 12 - Dolphin 9700 HomeBase Device (Model 9700-HB)

Overview.....	12-1
Parts and Functions.....	12-2
Power	12-4
Serial Connector.....	12-4
Charging the Main Battery.....	12-5
To Power a Terminal and Charge its Main Battery.....	12-5
Charging a Spare Battery in the Auxiliary Battery Well	12-5
Communication.....	12-6
Connecting the Communication Cables	12-6
Establishing Communication	12-6

Communicating with the Dolphin Terminal	12-7
Verifying Data Transfer.....	12-7
RS232 Communications Cables.....	12-7
RS232 Pin Configuration	12-8
Mounting.....	12-8
Desk Mounting.....	12-9

Chapter 13 - Dolphin 9700 Mobile Base Device (Model 9700-MB)

Overview.....	13-1
Front Panel	13-2
Bottom Panel	13-3
Powering the Dolphin Terminal	13-4
Charging the Dolphin Terminal.....	13-4
Mounting.....	13-4
Power	13-6
Establishing Communication	13-6
Connecting the Communication Cables	13-6
Establishing ActiveSync Communication.....	13-6

Chapter 14 - Dolphin 9700 ChargeBase Device (Model 9700-CB)

Overview.....	14-1
Parts and Functions.....	14-2
Supplying Power.....	14-3
Inserting and Removing Terminals	14-3
Charging Terminals	14-4
Mounting.....	14-4

Chapter 15 - Dolphin 9700 QuadCharger Device (Model 9700-QC)

Overview.....	15-1
Parts and Functions.....	15-2
Supplying Power.....	15-3
Inserting and Removing Battery Packs	15-3
Charging Batteries.....	15-4
Mounting.....	15-4
Desk Mounting.....	15-4
Troubleshooting.....	15-5

Chapter 16 - Customer Support

Product Service and Repair.....	16-1
Online Product Service and Repair Assistance	16-1
Technical Assistance	16-2
Online Technical Assistance.....	16-2
Limited Warranty	16-3
How to Extend Your Warranty	16-4



Agency Information

Dolphin 9700 mobile computers meet or exceed the requirements of all applicable standards organizations for safe operation. However, as with any electrical equipment, the best way to ensure safe operation is to operate them according to the agency guidelines that follow. Read these guidelines carefully before using your mobile computer.

Laser Safety

Label Locations

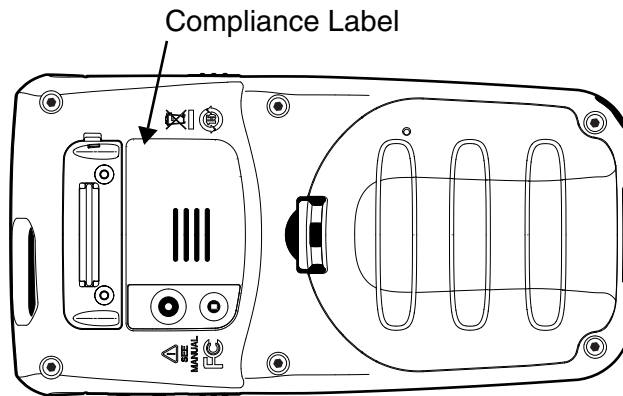

Laser Safety Label

If the following label is attached to your product, it indicates the product contains an engine with a laser aimer:

Image Engines with Integrated Laser Aimers

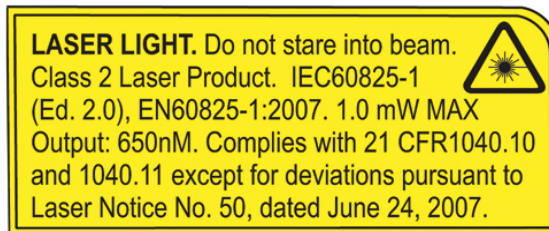

Laser Safety Statement

This device has been tested in accordance with and complies with IEC60825-1 (Ed. 2.0), EN60825-1: 2007. Complies with 21 CFR 1040.10 and 1040.11, except for deviations pursuant to Laser Notice No. 50, dated June 24, 2007. LASER LIGHT, DO NOT STARE INTO BEAM. CLASS 2 LASER PRODUCT, 1.0 mW MAX OUTPUT: 650nm.



WARNING - Use of controls or adjustments or performance of procedures other than those specified herein may result in hazardous radiation exposure.

LED Safety

LED Safety Statement

The LED output on this device has been tested in accordance with IEC60825-1 LED safety and certified to be a Class 1 LED device.

The maximum power outputs for each diode are as follows:

- Illumination LED: 194.0 uW, wavelength: 626nm+/-30nm
- Aimer laser (5300 engine): 360.1 uW, wavelength: 655nm
- Aimer LED (5100 engine): 81.6 uW, wavelength: 526nm+/-30nm

Infrared LED Safety Statement

CAUTION! Do not view directly with optical instruments.

The maximum power outputs for the IR LED is 145.1 uW. LEDs are pulsed at a frequency of 115,200 Hz with a duty cycle of 18.75% where the "ON" time of a single pulse is 1.6275×10^{-6} seconds.

UL and C-UL Statement

UL and C-UL listed: UL60950-1 2nd Edition and CSA C22.2 No. 60950-1-07 2nd Edition.

Approvals by Country

Country	EMC, Radio, & SAR	Safety
U.S.A.	FCC Part 15, Subpart B FCC Part 15, Subpart C, 15.247 FCC Part 15, Subpart E FCC Part 22H FCC Part 24E FCC SAR OET 65 Supplement C	UL60950-1 2nd Edition
Canada	ICES-003 (Class B) RSS 132 RSS 133 RSS 210	CSA C22.2 No. 60950-1-07 2nd Edition
European Community/CE	EN300328, EN301893, EN55022, EN55024, EN301489-1, EN301489-7/24 EN301489-17, EN300328, 3GPPTS 51.010-1 EN301511, EN301908, EN50360, EN50361, EN50371, EN50392 IEC6220-1 and IEC6220-2, EN300440	EN/IEC60950-1 2nd Edition EN/IEC60825-1 2nd Edition

This Class 2 Laser Product is in accordance with the requirements of IEC 60825-1 Ed. 2 Clause 6.2(a).

R&TTE Compliance Statement—802.11a/b/g, Bluetooth, and/or GSM

Dolphin RF terminals are in conformity with all essential requirements of the R&TTE Directive (1999/5/EC).

This product is marked with $\text{C} \text{E}$ 0682 D according to article 12 of the R&TTE Directive. In addition, this product complies to 2006/95/EC Low Voltage Directive when supplied with the recommended power supply. Honeywell shall not be liable for use of our product with equipment (i.e., power supplies, personal computers, etc.) that is not CE marked and does not comply with the Low Voltage Directive.

The equipment is intended for use throughout the European Community; PAN European Frequency Range: 2.402–2.480 GHz. Restrictions for use in France are as follows:

- Indoor use: Maximum power (EIRP*) of 100 mW for the entire 2.400–2.4835 GHz
- Outdoor use: Maximum power (EIRP*) of 100 mW for the 2.400–2.454 GHz band & maximum power (EIRP*) of 10 mW for the 2.454–2.483 MHz band.
- 5GHz band: UNII (Unlicensed National Information Infrastructure) or band1 (5.150 to 5.250 GHz) is restricted to indoor use only. Any other use will make the operation of the device illegal.

For further information, please contact:

Honeywell Imaging & Mobility Europe BV
Nijverheidsweg 9
5627 BT Eindhoven
The Netherlands

Dolphin RF Terminal—802.11a/b/g, Bluetooth, and/or GSM

This device complies with Part 15 of the FCC Rules. Operation is subject to the following two conditions: (1) this device may not cause harmful interference, and (2) this device must accept any interference received, including interference that may cause undesired operation.

This equipment has been tested and found to comply with the limits for a Class B digital device pursuant to Part 15 of the FCC Rules. These limits are designed to provide reasonable protection against harmful interference in a residential installation. This equipment generates, uses, and can radiate radio frequency energy and, if not installed and used in accordance with the instructions, may cause harmful interference to radio communications. However, there is no guarantee that interference will not occur in a particular installation. If this equipment does cause harmful interference to radio or television reception, which can be determined by turning the equipment off and on, the user is encouraged to try to correct the interference by one or more of the following measures:

- Reorient or relocate the receiving antenna.
- Increase the separation between the equipment and receiver.
- Connect the equipment into an outlet on a circuit different from that to which the receiver is connected.
- Consult the dealer or an experienced radio/TV technician for help.

If necessary, the user should consult the dealer or an experienced radio/television technician for additional suggestions. The user may find the following booklet helpful: "Something About Interference." This is available at FCC local regional offices. Our company is not responsible for any radio or television interference caused by unauthorized modifications of this equipment or the substitution or attachment of connecting cables and equipment other than those specified by our company. The correction is the responsibility of the user. Use only shielded data cables with this system.

In accordance with FCC 15.21, changes or modifications not expressly approved by the party responsible for compliance could void the user's authority to operate the equipment.

CAUTION! Any changes or modifications not expressly approved by the grantee of this device could void the user's authority to operate the equipment.

Canadian Compliance

This Class B digital apparatus complies with Canadian ICES-003 and RSS210. Operation is subject to the following two conditions:

1. This device may not cause harmful interference.
2. This device must accept any interference received, including interference that may cause undesired operation.

To prevent radio interference to the licensed service, this device is intended to be operated indoors and away from windows to provide maximum shielding. Equipment (or its transmit antenna) installed outdoors is subject to licensing.

Conformité à la réglementation canadienne

Cet appareil numérique de la Classe B est conforme à la norme NMB-003 et RSS210 du Canada. Son fonctionnement est assujéti aux conditions suivantes:

1. Cet appareil ne doit pas causer de brouillage préjudiciable.
2. Cet appareil doit pouvoir accepter tout brouillage reçu, y compris le brouillage pouvant causer un fonctionnement indésirable.

For European Community Users

Honeywell complies with Directive 2002/96/EC OF THE EUROPEAN PARLIAMENT AND OF THE COUNCIL of 27 January 2003 on waste electrical and electronic equipment (WEEE); European REACH Regulation 1907/2006 of 1 June, 2007 and Restriction of Hazardous Substances Directive (RoHS)2002/95/EC of 1 July 2006.

Waste Electrical and Electronic Equipment Information

This product has required the extraction and use of natural resources for its production. It may contain hazardous substances that could impact health and the environment, if not properly disposed.

In order to avoid the dissemination of those substances in our environment and to diminish the pressure on the natural resources, we encourage you to use the appropriate take-back systems for product disposal. Those systems will reuse or recycle most of the materials of the product you are disposing in a sound way.



The crossed out wheeled bin symbol informs you that the product should not be disposed of along with municipal waste and invites you to use the appropriate separate take-back systems for product disposal.

If you need more information on the collection, reuse, and recycling systems, please contact your local or regional waste administration.

You may also contact your supplier for more information on the environmental performances of this product.

Pacemakers, Hearing Aids and Other Electrically Powered Devices

Most manufacturers of medical devices adhere to the IEC 601-1-2 standard. This standard requires devices to operate properly in an EM Field with a strength of 3V/m over a frequency range of 26 to 1000MHz. The maximum allowable field strength emitted by the Dolphin terminal is 0.3V/m according to Subpart B of Part 1 of the FCC rules. Therefore, the RF from the Dolphin terminal has no effect on medical devices that meet the IEC specification.

Hearing Aid Compatibility (HAC)

The Dolphin 9700 has been tested for hearing aid compatibility. This device has an M3 and T3 rating. For additional HAC information, including the HAC rating for this product, please refer to www.honeywellaidc.com.

When some wireless devices are used near some hearing devices such as hearing aids and implants, users may detect a buzzing or humming noise. Some hearing devices are more immune than others to this interference noise. Wireless devices may also vary in the amount of interference they generate.

The ratings for compatibility of digital wireless devices with hearing aids are described in the American National Standards Institute (ANSI) C63.19 standard:

M-Rating: Phones rated M3 or M4 meet FCC requirements and are likely to generate less interference with hearing devices than phones that are not labeled. M4 is the superior/higher of the two ratings.

T-Rating: Phones rated T3 or T4 meet FCC requirements and are likely to be more usable with hearing devices' telecoil than unrated phones. T4 is the superior/higher of the two ratings.

The more immune the hearing aid device is, the less likely one is to experience interference noise from the wireless phone. Hearing aid devices may also be rated. Adding the ratings of the hearing aid and the phone would determine probable usability:

- Any combined rating equal to or greater than six offers the best use.
- Any combined rating equal to five is considered normal use.

The ratings are not guarantees. Results will vary depending on the user's hearing device and hearing loss. If your hearing device happens to be vulnerable to interference, you may not be able to use this device successfully. Trying out this device with your hearing device is the best way to evaluate it for your personal needs.

This device has been tested and rated for use with hearing aids for some of the wireless technologies that it utilizes. However, there may be some newer wireless technologies used in this phone that have not been tested yet for use with hearing aids. It is important to try the different features of this phone thoroughly and in different locations, using your hearing aid or cochlear implant, to determine if you hear any interfering noise. Consult your service provider or the manufacturer of this phone for information on hearing aid compatibility.

Microwaves

The radio in the Dolphin RF terminal operates on the same frequency band as a microwave oven. Therefore, if you use a microwave within range of the Dolphin RF terminal you may notice performance degradation in your wireless network. However, both your microwave and your wireless network will continue to function.

Informações ANATEL

Este produto está homologado pela Anatel, de acordo com os procedimentos regulamentados pela Resolução No. 242/2000 e atende aos requisitos técnicos aplicados incluindo os limites de exposição da Taxa de Absorção Específica referente a campos elétricos, magnéticos e eletromagnéticos de radiofrequência, de acordo com a Resolução No. 303/2002 e nº 533/2009.



1076-10-4741



(01)07898927490058

Este produto é compatível com o carregador, modelo: DAS-0421S-09 1 38 e bateria, modelo: 200003231

" Este equipamento opera em caráter secundário, isto é, não tem direito a proteção contra interferência prejudicial, mesmo de estações do mesmo tipo, e não pode causar interferência a sistemas operando em caráter primário."

Para maiores informações, consulte o site da ANATEL - www.anatel.gov.br

China RoHS

部件名称 (Parts Name)	有毒有害物质名称及含量的标识格式 (Names and Content of Hazardous Substances or Elements)					
	铅 (Pb)	汞 (Hg)	镉 (Cd)	六价铬 (Cr6+)	多溴联苯 (PBB)	多溴二苯醚 (PBDE)
成像式条码阅读器 (Imager)	x	o	o	o	o	o
印刷电路板 (PCB)	x	o	o	o	o	o
外壳 (Housing)	o	o	o	o	o	o
连线 (Cables)	x	o	o	o	o	o
液晶显示器 (LCD)	x	o	o	o	o	o
电池 (Battery)	o	o	o	o	o	o
机座 (Mainframe)	o	o	o	o	o	o
键盘 (Keypad)	o	o	o	o	o	o

o: 表示该有毒有害物质在该部件所有均质材料中的含量均在SJ/T11363-2006标准规定的限量要求以下 (Indicates that this toxic or hazardous substance contained in all of the homogeneous materials for this part is below the limit requirement in China's SJ/T11363-2006.)
x: 表示该有毒有害物质至少在该部件的某一均质材料中的含量超出 SJ/T11363-2006 标准规定的限量要求 (Indicates that this toxic or hazardous substance contained in at least one of the homogeneous materials for this part is above the limit requirement in China's SJ/T11363-2006.)

Getting Started

Out of the Box

Verify that the carton contains the following items:

- Dolphin 9700 mobile computer (the terminal)
- Main battery pack
- Quick Start Guide

Note: If you ordered accessories for your terminals, verify that they are also included with the order.

Be sure to keep the original packaging in the event that the Dolphin terminal should need to be returned for service. For details, see [Product Service and Repair](#) on page 16-1.

Step 1. Install the Main Battery Pack

Dolphin 9700 model terminals are designed for use with battery pack models 200003231 (Li-ion 7.4V, 12.0 watt hour) and 9700-BTEC (Li-ion 7.2V 14.4 watt hour) manufactured for Honeywell International Inc. The 9700 is shipped with the battery packaged separate from the unit. Follow the steps below to install the main battery.



Ensure all components are dry prior to placing the battery in the terminal. Mating wet components may cause damage not covered by the warranty.

1. Release the hand strap near the base of the terminal making it easier to access the battery door.
2. Remove the battery door by releasing the door latch and pulling up with a hinging motion.
3. Insert the battery into the battery well.

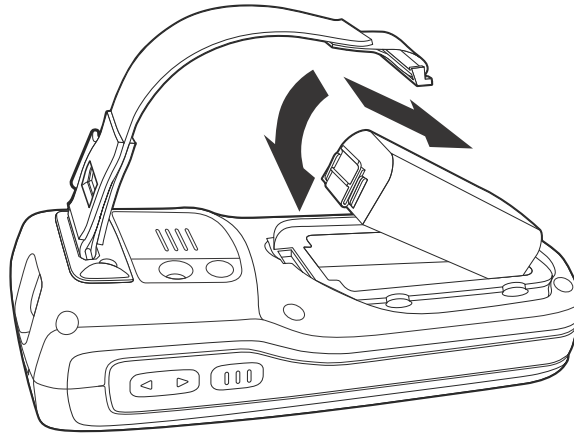

4. Replace the battery door. Apply pressure to engage the door latch.

Note: The battery door must be installed prior to powering the unit.

5. Reattach the hand strap.



We recommend use of Honeywell Li-Ion battery packs. Use of any non-Honeywell battery may result in damage not covered by the warranty.

Step 2. Charge the Main and Backup Batteries

The power supply for Dolphin terminals consists of two types of battery power: the main battery pack that is accessible from the back panel, and the backup battery that resides inside the terminal.

The main battery powers the terminal. The internal backup battery charges off the main battery and maintains the application data stored in RAM memory for up to 30 minutes when the terminal's main battery pack is completely discharged or removed.

Before Initial Use

Terminals are shipped with both batteries discharged of all power. The initial charging time for the main battery pack is 4 hours and 8 hours for the internal backup battery. Connect the terminal to one of the 9700 series charging peripherals to charge; see [Peripherals for the 9700](#) on page 3-2.

Dolphin 9700 terminals are designed for use with the following 9700 charging devices and cables: 9700-CB, 9700-EHB, 9700-HB, 9700-MB, 9700-NB, 9700-MC, 9700-RS232, 9700-USB.

 *We recommend use of Honeywell peripherals, power cables, and power adapters. Use of any non-Honeywell peripherals, cables, or power adapters may cause damage not covered by the warranty.*

Charging Using the Communication Cable (9700-RS232 or 9700-USB)

Use only UL Listed power supply, which has been qualified by Honeywell with output rated at 9.5VDC and 1.7 amps with the device.

 *Ensure all components are dry prior to mating terminals/batteries with peripheral devices. Mating wet components may cause damage not covered by the warranty.*

1. Connect the USB or RS232 cable to the I/O connector on the terminal.
2. Tighten the thumb screws on the cable cup to secure the cable to the terminal.
3. Plug the power cord into the power adapter.
4. Plug the power adapter cable into the power connector on COMM cable.
5. Plug the COMM cable into the appropriate port on the host device.
6. Plug the power cord into a standard wall outlet.
7. The LED on the front of the terminal flashes and illuminates as the terminal starts to initialize the boot process.

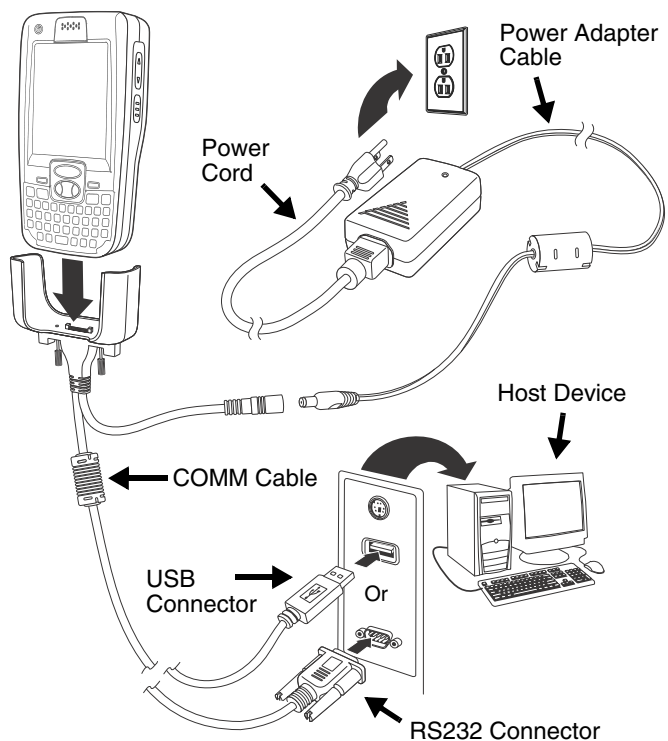

Step 3. Boot the Terminal

The terminal begins booting as soon as power is applied. Do NOT press any keys or interrupt the boot process. When the boot process is complete, the Today screen appears, and the terminal is ready for use.

Note: The Today screen appears several times during the boot process. To ensure the boot process is complete, wait several seconds before using the device.

Step 4. Set the Time Zone, Time, and Date

On the Today screen, tap the line that displays the time and date.

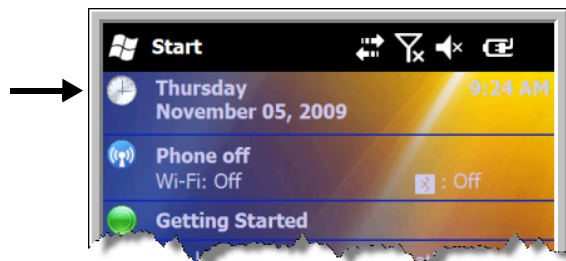

The Clock Settings screen appears.

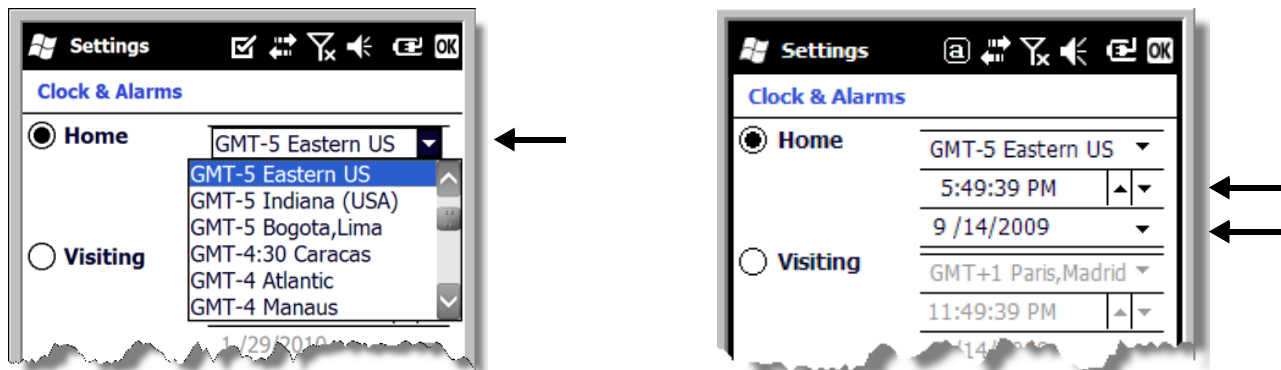

Tap the arrow to the right of the time zone to open the drop down menu. Select the appropriate time zone from the menu. Set the correct time and date in the remaining fields and tap **OK** to save.

Today Screen

After the Dolphin terminal initializes the first time, you see the Today screen.

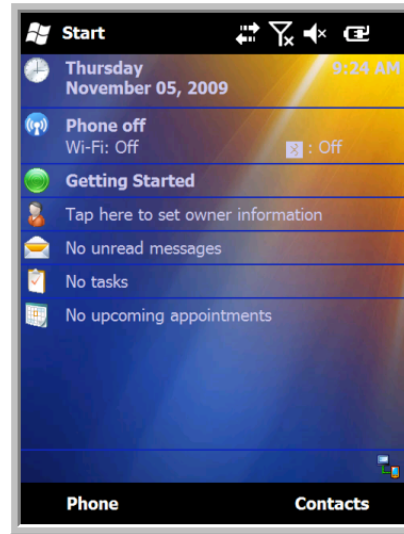

You can also display the Today screen anytime by tapping  **Start** and then Today.





Navigation Bar

The Navigation bar, located at the top of the screen, displays the active program and current time. It also provides access to the Start menu, which allows you to open programs and access the system settings.























Note: Tapping the battery icon at the top of the screen does not open the Power applet with this version of Microsoft Windows Mobile.

















Icons in the Navigation Bar

Indicator	Meaning
	Synchronizing data
	The terminal could not synchronize data with the workstation via ActiveSync.
	New e-mail
	New text message
	New voicemail

Icons in the Navigation Bar

Indicator	Meaning
	New instant message
	Vibrate on
	Ringer off
	Speakerphone on
	Voice call in progress
	Calls are forwarded
	Call on hold
	Missed call
	Data call in progress
	Battery is has a full charge
	Battery has a high charge
	Battery has a medium charge
	Battery has a low charge
	Battery has a very low charge and requires charging
	Terminal is running on external power. If a battery pack is installed, the battery is charging in the background.
	The terminal is not connected to external power. A battery is installed, but is defective; specifically, its charge level cannot be measured.
	No SIM card is installed
	GPRS available
	GPRS connecting
	GPRS in use
	HSDPA available

Icons in the Navigation Bar

Indicator	Meaning
	HSDPA connecting
	HSDPA in use
	EDGE available
	EDGE connecting
	EDGE in use
	UMTS available
	UMTS connecting
	UMTS in use
	Radio is off
	The radio is not connected to a network.
	The radio is connected. The bars indicate the signal strength.
	No radio signal
	The terminal is searching for a signal.
	Wi-Fi is on, but device is not connected
	Wi-Fi data call
	Pending alarm
	Bluetooth

Command Bar

The Command bar is located at the bottom of application windows.

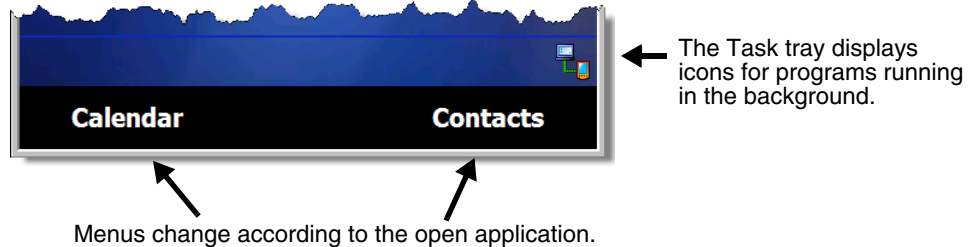

Pop-Up Menus

With pop-up menus, you can quickly choose an action for a selected item. To access a pop-up menu, tap and hold the stylus on the item name of the action you want to perform. When the menu appears, lift the stylus, and tap the action you want to perform.

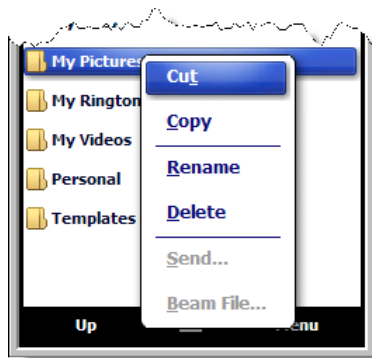

Tap anywhere outside the menu to close the menu without performing an action.

Selecting Programs

To see the programs loaded on your terminal, tap  **Start** to access the Start Menu. To open a program, tap once on the program icon.

To move an icon to the top of the Start Menu, tap and hold the stylus on the icon you want to move. Tap on **Move to Top**.

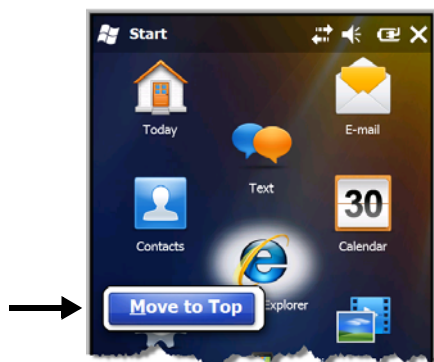

File Explorer

You can also use the File Explorer to find files and organize these files into folders.

Tap **Start > File Explorer**  .

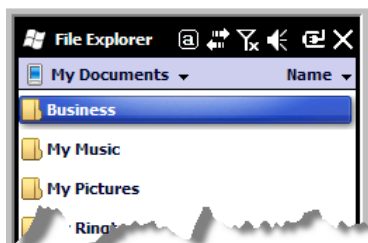

Tap the **Up** button at the bottom of the screen to move up one level in the directory.



You can move files in File Explorer by tapping and holding on the item you want to move, and then tapping **Cut** or **Copy** on popup menu.

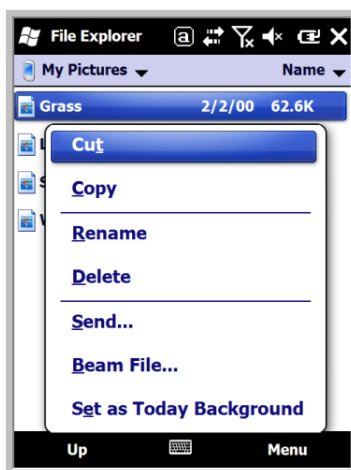

Navigate to the folder you want to move the file to, and then tap and hold a blank area of the window. Tap **Paste** on the pop-up menu.

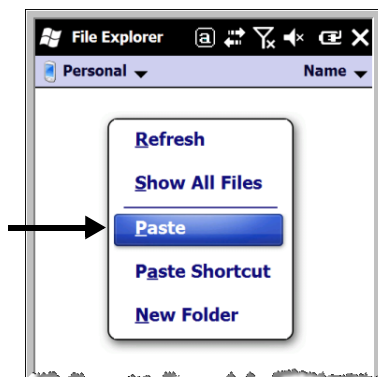

*Note: If there is no blank space available in the window, tap **Menu** on the command bar, navigate to the end of the menu using the down arrow, and then tap **Edit > Paste**.*

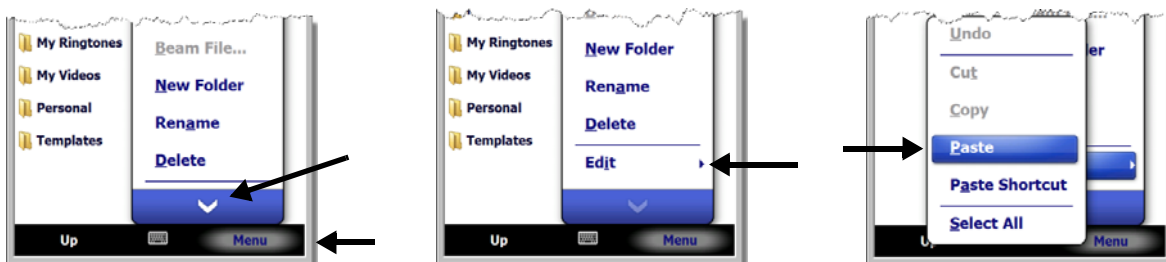

Search

The Search feature helps you quickly locate information. Tap **Start > Search Phone** .

Enter the text you want to find, select a data type, and then tap **Go** to start the search. Select **Larger than 64 KB** in the **Type** drop-down field to quickly find information that is taking up storage space.



Hardware Overview

Standard Configurations for the 9700

WLAN & WPAN

- Microsoft® Windows Mobile® 6.5 Classic
- Marvell® PXA270 624 MHz
- 256MB SDRAM X 1GB Flash
- Two keyboard options: 45-Key Qwerty or 31-Key Numeric
- Li-ion rechargeable battery pack
- Adaptus Imaging Technology: 5100SR/SF or 5300SR/SF/HD image engines
- 802.11a/b/g and Bluetooth

WLAN, WPAN, with GPS

- Microsoft® Windows Mobile® 6.5 Classic
- Marvell® PXA270 624 MHz
- 256MB SDRAM X 1GB Flash
- Two keyboard options: 45-Key Qwerty or 31-Key Numeric
- Li-ion rechargeable battery pack
- Adaptus Imaging Technology: 5100SR/SF or 5300SR/SF/HD image engines
- 802.11a/b/g and Bluetooth
- GPS
- 2.0 megapixel auto control color camera

WLAN, WPAN, & WWAN

- Microsoft Windows Mobile 6.5 Professional
- Marvell PXA270 624 MHz
- 256MB SDRAM X 1GB Flash
- Two keyboard options: 45-Key Qwerty or 31-Key Numeric
- Li-ion rechargeable battery pack
- Adaptus Imaging Technology: 5100SR/SF or 5300SR/SF/HD image engines
- 802.11a/b/g, Bluetooth, and GSM/GPRS/EDGE/UMTS/HSDPA

WLAN, WPAN, WWAN with GPS & Camera

- Microsoft Windows Mobile 6.5 Professional
- Marvell PXA270 624 MHz
- 256MB SDRAM X 1GB Flash

WLAN, WPAN & Camera

- Microsoft® Windows Mobile® 6.5 Classic
- Marvell® PXA270 624 MHz
- 256MB SDRAM X 1GB Flash
- Two keyboard options: 45-Key Qwerty or 31-Key Numeric
- Li-ion rechargeable battery pack
- Adaptus Imaging Technology: 5100SR/SF or 5300SR/SF/HD image engines
- 802.11a/b/g and Bluetooth
- 2.0 megapixel auto control color camera

WLAN, WPAN, with GPS & Camera

- Microsoft® Windows Mobile® 6.5 Classic
- Marvell® PXA270 624 MHz
- 256MB SDRAM X 1GB Flash
- Two keyboard options: 45-Key Qwerty or 31-Key Numeric
- Li-ion rechargeable battery pack
- Adaptus Imaging Technology: 5100SR/SF or 5300SR/SF/HD image engines
- 802.11a/b/g and Bluetooth
- GPS
- 2.0 megapixel auto control color camera

WLAN, WPAN, & WWAN with GPS

- Microsoft Windows Mobile 6.5 Professional
- Marvell PXA270 624 MHz
- 256MB SDRAM X 1GB Flash
- Two keyboard options: 45-Key Qwerty or 31-Key Numeric
- Li-ion rechargeable battery pack
- Adaptus Imaging Technology: 5100SR/SF or 5300SR/SF/HD image engines
- 802.11a/b/g, Bluetooth, and GSM/GPRS/EDGE/UMTS/HSDPA
- GPS

-
- Two keyboard options: 45-Key Qwerty or 31-Key Numeric
 - Li-ion rechargeable battery pack
 - Adaptus Imaging Technology: 5100SR/SF or 5300SR/SF/HD image engines
 - 802.11a/b/g, Bluetooth, and GSM/GPRS/EDGE/UMTS/HSDPA
 - GPS
 - 2 mega pixel auto control color camera

Some configurations of the 9700 terminal are available with an external housing made of plastic that is specifically designed for the healthcare industry. For more information, see [Healthcare Housing](#) on page 3-11.

Peripherals for the 9700

Each of the following items is sold separately to enhance the capabilities of your Dolphin terminal.

Dolphin 9700 HomeBase™ Device

The Dolphin 9700 HomeBase device is a charging and communication cradle supporting both RS232 and USB communications, which enables the terminal to interface with the majority of PC-based enterprise systems. This device also contains an auxiliary battery well that charges a spare Li-ion battery. For more information, see [Dolphin 9700 HomeBase Device \(Model 9700-HB\)](#) on page 12-1.

Dolphin 9700 eBase™ Device

The Ethernet Base (eBase) enables a single Dolphin 9700 computer to communicate with a host device over an Ethernet network. This device also contains an auxiliary battery well that charges a spare Li-ion battery. For more information, refer to the *Dolphin 9700 eBase User's Guide* located on the Web at www.honeywellaidc.com.

Dolphin 9700 Mobile Base™ Device

The Dolphin 9700 Mobile Base device is a charging and communication cradle designed specifically for in-premise and in-transit data collection applications. It features a flexible mounting bracket, and a cigarette lighter adapter or power cable to adapt it to your environment.

The serial connector supports RS232 communication and power out to peripheral devices, such as handheld scanners. For more information, see [Dolphin 9700 Mobile Base Device \(Model 9700-MB\)](#) on page 13-1.

Dolphin 9700 ChargeBase

The Dolphin 9700 ChargeBase is a 4-slot charging cradle that holds, powers, and charges terminals. For more information, see [Dolphin 9700 ChargeBase Device \(Model 9700-CB\)](#) on page 14-1.

Dolphin 9700 Net Base™ Device

The Net Base enables up to four Dolphin 9700 mobile computers to communicate with a host device over an Ethernet network. In addition, the Net Base provides a second RJ45 Ethernet port for connection to an additional device such as a printer, workstation, eBase, or another Net Base. For more information, refer to the *Dolphin 9700 Net Base User's Guide* located on the Web at www.honeywellaidc.com.

Dolphin 9700 QuadCharger™ Device

The Dolphin 9700 QuadCharger device is a 4-slot charging station for 9700 Li-ion battery packs. The fourth slot features a battery analyzer that completely resets and re-calibrates a battery and displays its resulting capacity. For more information, see [Dolphin 9700 QuadCharger Device \(Model 9700-QC\)](#) on page 15-1.

Accessories for the 9700

Each of the following items is sold separately to enhance your terminal's capabilities.

Note: When using accessories where the terminal is worn on the body, the terminal's touch panel must face away from the body.

Dolphin 9700 Mobile Charger

The Dolphin 9700 Mobile Charger is a charging cable that connects the terminal directly to a 12 Volt DC power source, such as a cigarette lighter port inside a vehicle, eliminating the need for a cradle. Intelligent battery technology on-board the terminal ensures proper charging. The Dolphin 9700 Mobile Charger is an ideal low-cost charging solution for in-transit mobile applications.

Dolphin 9700-MSCR

The Magnetic Stripe and Smart Card Reader (MSCR) for the Dolphin 9700 enables easy data capture with the swipe of a magnetic stripe card or smart card insertion. The MSCR snaps onto the bottom panel of the Dolphin terminal for easy installation or removal. For more information, refer to the *Dolphin 9700-MSCR Quick Start Guide* located on the Web at www.honeywellaidc.com.

Communication/Charging Cables

Dolphin communication/charging cable kits are an all-in-one solution for mobile applications. Each cable kit powers the terminal, charges its main battery, and communicates with host or peripheral devices without the need for a cradle. Cable kits can support RS232 or USB communications and are available with U.K. or European power cords.

Protective Holster

Holsters provide convenient storage for terminals and protect them from damage in mobile environments. Both holsters feature a front pocket that holds an extra battery, a side pocket to hold an extra stylus, and a belt loop to secure the holster to a belt.

Protective Enclosure

Protective enclosures help seal and protect terminals from damage while providing full access to all terminal parts and features. These enclosures feature a swivel clip on the back that enables you to secure the enclosure to a belt. Enclosures also come with an adjustable shoulder strap for added convenience.

Stylus Kits

There are two stylus kits: one contains three styli and the other includes additional coiled tethers to secure the stylus to the terminal, which helps prevent loss.

Li-ion Battery Pack

The Li-ion rechargeable battery pack provides the main power for the terminal, see [Batteries](#) on page 3-12.

Front Panel: 9700

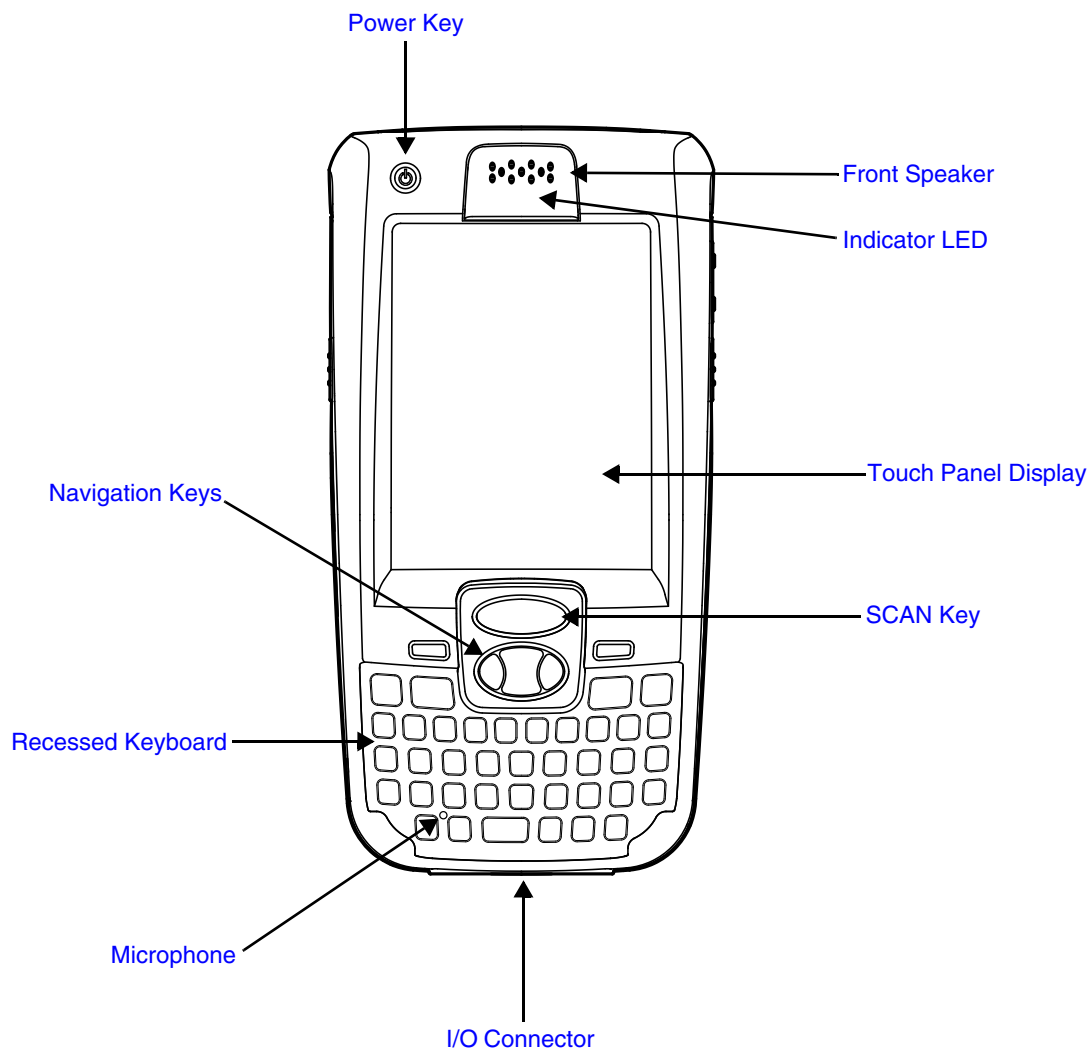

For a description of each callout, see [Front Panel Features for the 9700](#) on page 3-5.

Front Panel Features for the 9700

Blue Modifier Key

See [Using the Modifier Keys](#) on page 6-3.

Front Speaker

The front speaker is the receiver for handset voice calls. See [Voice Communication](#) on page 9-4.

Indicator LED

The light emitting diode (LED) located at the top of the LCD display flashes and illuminates during resets and scanning/imaging. This LED can be programmed by various software applications.

Microphone

The integrated microphone that provides audio input for handset and speakerphone voice calls. See [Voice Communication](#) on page 9-4.

Navigation Keys

The centrally located navigation keys enable you to move and position the cursor through software programs. The up and down arrows are programmed to perform specific functions when pressed in combination with the Blue and Red modifier keys. For more details, see [Using the Navigation Keys](#) on page 6-3.

Power Key

The red power key puts the terminal in Suspend Mode or wakes the terminal from Suspend Mode. See [Suspend Mode](#) on page 3-15.

Recessed Keyboard

There are two keyboard options: a 31-key numeric keyboard or a 45-key QWERTY keyboard. For a complete overview of each keyboard, see [Using the Keyboards](#) on page 6-1.

Red Modifier Key

See [Using the Modifier Keys](#) on page 6-3.

SCAN Key

The SCAN key is centrally located for easy access with the right or left hand. When pressed, the SCAN key activates the scanner/imager. The SCAN key also functions as a system wake-up control for the terminal.

Touch Panel Display

The color 3.7 inch liquid crystal display (LCD) touch panel is covered with an industrial, protective lens for greater durability. The video graphic array (VGA) display resolution is 480 X 640.

The 262K color (18 bit RGB) LCD uses thin film transistor (TFT) technology. The touch panel backlight illuminates when the screen is touched, but not when the Backlight key is pressed. For more information, see [Backlight](#) on page 7-9.

The touch panel can be activated by the stylus (included with the terminal) or a finger. For more information, see [Using the Touch Panel](#) on page 3-10.

Back Panel: 9700

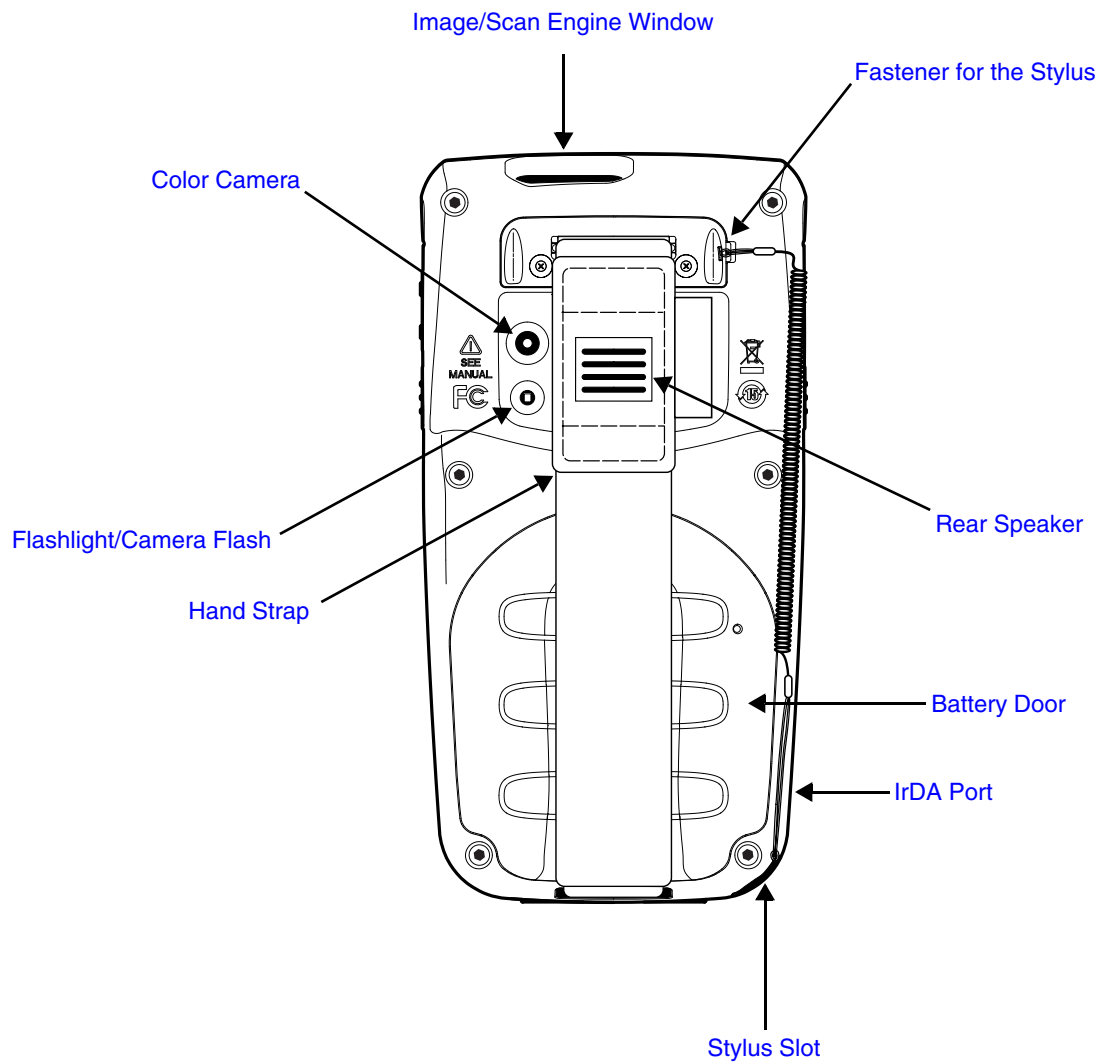

For a description of each callout, see [Back Panel Features for the 9700](#) on page 3-7.

Back Panel Features for the 9700

Battery Door

The battery door secures the Li-ion battery pack in the terminal's battery well. For more information, see [Batteries](#) on page 3-12.

Color Camera

The 2.0-Megapixels Resolution (1600 x 1200 pixel) color camera provides easy picture capture with Automated Camera Control (ACC). Additional features include automated picture profiles and an Application Programming Interface (API).

Fastener for the Stylus Tether

Stylus tethers can be purchased separately to help prevent accidental loss when the stylus is not stored in the stylus slot. A stylus tether is a coiled, elastic cord that tethers the stylus to the terminal. Secure one end of the cord to the back panel of the terminal and the other end to the stylus.

Flashlight/Camera Flash

The flashlight/camera flash is located on the back panel of the terminal. When used as a Flashlight, press the Blue key + SCAN key to turn the flashlight on or off. When used as a Camera Flash with the terminal's color camera, the flash is controlled by the camera application.

Hand Strap

The 9700 comes with a removable, elastic hand strap. The hand strap includes a stylus holder that accommodates a variety of stylus sizes.

Image/Scan Engine Window

The available image engines read and decode linear, stacked linear (e.g., PDF417), and 2D matrix bar code symbologies. The available image engines contain a laser aimer for greater accuracy. The laser apertures for the imaging engines' laser aimers are contained behind this window. For more details, see [Using the Scan Image Engine](#) on page 4-1.

Memory Card Socket and SIM Card Socket

The memory card socket provides the user with the option to expand the terminal's memory capacity using industry-standard microSD or microSDHC memory interfaces. The expansion socket is located under the main battery in the battery well.

When the battery pack and battery door are properly installed, the memory card is sealed against moisture and particle intrusion, read/write data is stored securely, and the terminal's environmental rating is preserved; see [Installing a Memory Card](#) on page 3-9.

The card socket for the Subscriber Identity Module (SIM) is also located under the main battery in the battery well. See [SIM Card Installation](#) and [SIM Card Requirements](#), on page 9-2 for additional information.

Rear Speaker

The integrated rear speaker sounds audio signals as you scan bar code labels and enter data. The integrated speaker also supports playback of wave and MP3 files, software mixer, and Speakerphone for WWAN/GSM audio and VoIP. The operating frequency range is 600-3000Hz at >90dB.

Stylus Slot

The stylus is used to operate the touch panel. The back panel of the terminal features a storage slot to hold the stylus when not in use. The stylus features a special tip for added accuracy and ease of use.



Side Panels: 9700

The left and the right side panels of the Dolphin contain different features.

Left Side

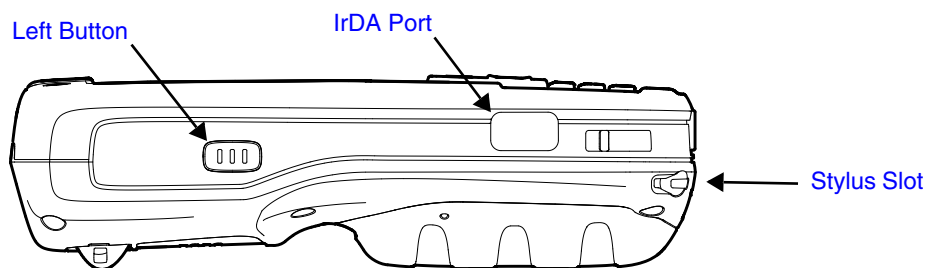

Left Button

By default, the Left Button triggers the scanner/imager. You can reassign the button to launch applications or execute commands. For additional information, see [Changing Button Assignments](#) on page 7-4.

IrDA Port

The IrDA port enables infrared communication. The maximum data transfer speed is 115 kbps. For more information about using this port, see [Using the IrDA Port](#) on page 8-2.

Note: The infrared LED aperture is located behind the IrDA Port window.

Right Side

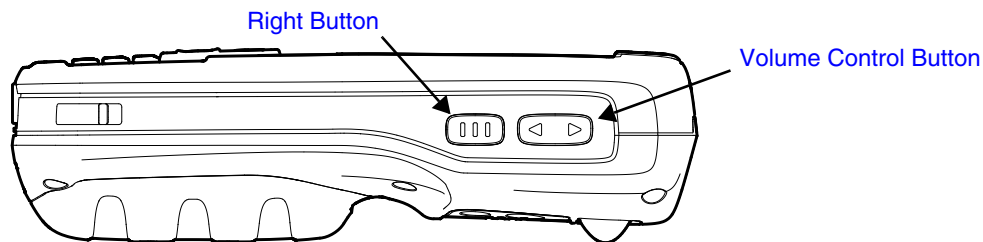

Right Button

By default, the Right Button triggers the scanner/imager. You can reassign the button to launch applications or execute commands. For additional information, see [Changing Button Assignments](#) on page 7-4.



Volume Control Button

Press the up or down arrows on the volume button to raise or lower the volume of the active speaker.

Installing a Memory Card

1. Press the Power key  to put the terminal in Suspend Mode.
2. Release the hand strap near the base of the terminal.
3. Remove the battery door and the battery.
4. Remove the protective cover over the memory socket.
5. Unlock the access door to the memory socket by sliding the door away from the serial number label located in the battery well.
6. Lift the door up to expose the socket.
7. Insert the microSD or microSDHC card into the socket.

Note: Make sure the interface on the memory card is connected to the interface in the socket; align the notch on the card with the notch of the socket.

8. Close and lock the access door by sliding the door toward the serial number label.
9. Replace the protective cover over the memory socket.
10. Install the battery and the battery door.
11. Press and hold the RED  + TAB  keys for approximately 5 seconds.
12. The decode and scan LEDs flash for approximately three seconds as the terminal resets.
13. When the reset is complete, the Today screen displays.

Note: Honeywell recommends formatting all SD cards before initial use.

Installing a SIM Card

See [Installing a SIM Card](#) on page 9-3.

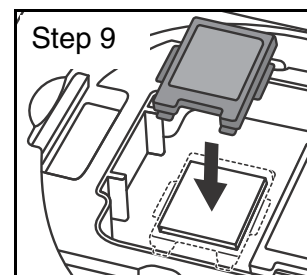
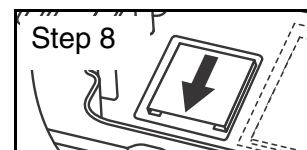
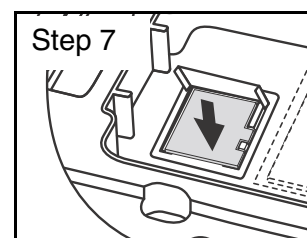
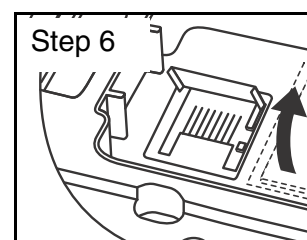
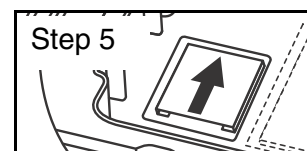
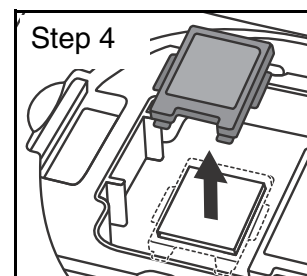

Bottom Panel: 9700

Pin	Description
1	GND
2	MIC_IN
3	RI
4	USB_D-
5	USB_D+
6	AUDIO_GND
7	USB_5V_IN
8	5V_OUT
9	TXD
10	RXD
11	RTS
12	CTS
13	DTR
14	DSR
15	MONO SPEAKER
16	VDC_IN

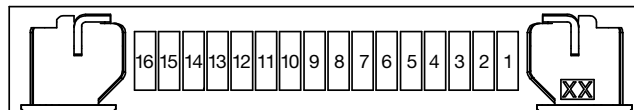

Note: Signals referenced are for a DTE device.

I/O Connector

The I/O connector powers the terminal, charges the main battery, and facilitates communication. All Dolphin peripherals are designed to work exclusively with this connector.

The I/O connector supports RS232 and USB communication. For RS232, the maximum communication speed is 115.2 Kbps with seven baud rate settings. For USB, the communication speed is up to 12 Mbps.

I/O Power Out

The I/O connector also provides power out (to peripheral devices) +5V at 500mA. This means that, with the proper cable, the terminal can power another device. By default, power out is disabled, but the 5V output may be turned on programmatically.

Using the Touch Panel

Honeywell defines proper use of the terminal touch panel as using a screen protector and proper stylus. Screen protectors maintain the ongoing integrity (i.e., prevent scratching) of the touch panel, which is why their use is recommended for applications that require a high to medium level of interface with the touch panel, such as signature capture for proof of delivery.

Honeywell advocates the use of screen protectors on all Dolphin devices. We recommend implementing a screen protector replacement program to ensure that screen protectors are replaced periodically when signs of damage/wear are noticeable. For general use, we recommend replacing the screen protector every thirty (30) days. However, replacement cycles vary according to the average level of touch panel use in your application.

Replacement screen protectors can be purchased directly from Honeywell. Please contact a Honeywell sales associate for details.

Honeywell also mandates use of a proper stylus, which is one that has a stylus tip radius of no less than 0.8mm. Use of the Honeywell stylus included with the terminal is recommended at all times.

Honeywell warranty policy covers wear on the touch panel for the first 12 months if a screen protector is applied and an approved stylus is used for the 12 month duration covered by the warranty.

Installing a Screen Protector

Dolphin terminals ship with a screen protector already installed. You will need to replace the screen protector at regular intervals.

1. After the current screen protector has been removed from the touch panel, clean the touch panel thoroughly with a clean, non-abrasive, lint-free cloth. Make sure there is no debris on the touch panel.
2. Align the exposed section of the protector with the bottom edge of the touch panel. Make sure that the screen protector is flush with each side of the touch panel. To reposition, lift up gently and reapply.
3. Press the screen protector firmly and carefully across the surface of the touch panel as you peel away the backing.
4. If necessary, smooth out any air pockets or bumps.

Healthcare Housing

Some configurations of the 9700 terminal are available with an external plastic housing that is designed to resist the effects of harsh chemicals in a healthcare environment. The plastic is crystalline in nature, which helps prevent chemicals from seeping through the housing.

Important! The following cleaning solutions have been tested to assure safe cleaning of your terminal's disinfectant-ready housing. They are the only solutions approved for use with these terminals. Damage caused by the use of cleaners other than those listed below may not be covered by the warranty.

- Sani-Cloth® HB wipes
- Sani-Cloth® Plus wipes
- Sani-Cloth® Bleach wipes
- Super Sani-Cloth® wipes
- Isopropyl Alcohol wipes (70%)
- CaviWipes™
- Virex® 256
- 409® Glass and Surface Cleaner
- Windex® Blue
- Gentle dish soap and water

Batteries

There are two types of battery power: the main battery pack installed in the back panel and the backup battery located inside the terminal. They are designed to work together to prevent data loss when the terminal is in use over long periods.

Both batteries must be completely charged before using a Dolphin terminal for the first time!

Main Battery Pack



We recommend use of Honeywell Li-Ion battery packs. Use of any non-Honeywell battery may result in damage not covered by the warranty.

Dolphin 9700 model terminals are designed for use with battery pack models 200003231 (Li-ion 7.4V, 12.0 watt hour) and 9700-BTEC (Li-ion 7.2V 14.4 watt hour) manufactured for Honeywell International Inc. The Li-ion battery pack is the primary power source for the terminal and is designed to operate in a temperature range of -10° to 50°C (14° to 122°F).

Charging Options

When the Li-ion battery is installed in the terminal, use one of the following peripherals:

- [Dolphin 9700 HomeBase Device \(Model 9700-HB\)](#) (see page 12-1)
- [Dolphin 9700 Mobile Base Device \(Model 9700-MB\)](#) (see page 13-1)
- [Dolphin 9700 ChargeBase Device \(Model 9700-CB\)](#) (see page 14-1)
- Dolphin 9700 eBase Device
- Dolphin 9700 Net Base Device

When the Li-ion battery is not installed in the terminal:

- Place the battery pack in the [Dolphin 9700 QuadCharger Device \(Model 9700-QC\)](#) (see page 15-1) or
- Place the battery pack in the [Auxiliary Battery Well](#) of the [Dolphin 9700 HomeBase Device \(Model 9700-HB\)](#) (see page 12-1), Dolphin 9700 eBase Device, or Dolphin 9700 Net Base Device.

Charging Time

The Li-ion battery pack requires 4 hours to charge completely before initial use.

Storing Batteries

To maintain optimal battery performance, follow these storage guidelines:

- Avoid storing batteries outside the specified range of -4° to 104° F (-20° to 40°C) or in extremely high humidity.
- For prolonged storage, do not keep batteries stored in a charger that is connected to a power source.

Guidelines for Battery Pack Use and Disposal

The following are general guidelines for the safe use and disposal of batteries:

- We recommend use of Honeywell Li-Ion battery packs. Use of any non-Honeywell battery may pose a personal hazard to the user.
- Replace defective batteries immediately; using a defective battery could damage the Dolphin terminal.
- Never throw a used battery in the trash. A battery contains heavy metals and should be recycled according to local guidelines.
- Do not use a battery in any other manner outside its intended use in Dolphin terminals and peripherals.
- Do not short-circuit a battery or throw it into a fire; it can explode and cause severe personal injury.

-
- Excessive discharge damages a battery. Recharge the battery when your terminal indicates low battery power.
 - If you observe that the Honeywell battery supplied is physically damaged, please send it to Honeywell International Inc. or an authorized service center for inspection. Refer to the Product Service and Repair section of this guide.
 - Although your battery can be recharged many times, the battery life is limited. Replace it after the battery is unable to hold an adequate charge.
 - If you are not sure the battery or charger is working properly, send it to Honeywell International or an authorized service center for inspection.

Internal Backup Battery

Located inside the terminal, the backup battery is a 3.6 Volt nickel metal hydride (NiMH) battery.

The internal backup battery prevents the terminal from being reset if you need to remove and replace the main battery pack. It retains RAM data. If the terminal is left without the main battery pack for more than 30 minutes, the internal backup battery needs to be recharged to function according to its specifications.

Note: Data and programs stored in Flash memory are not lost even if the internal backup battery fails.

Charging

The internal backup battery is powered by the main battery pack. Therefore, charging the internal backup battery requires that the main battery pack be installed in the terminal and the terminal be connected to a charging device.

The internal backup battery must be fully charged before using the terminal for the first time. The initial charge cycle takes approximately 8 hours. After that, if the internal backup battery becomes fully discharged of power, it requires a minimum of 10 hours of charging time to function normally.

Guidelines for Use

Follow these guidelines to maximize the life of the internal backup battery:

- Keep a charged Li-ion battery pack in the terminal; the backup battery prematurely discharges if there is not at least a partially charged battery in the terminal.
- Keep the terminal connected to power when the terminal is not in use.

Managing Battery Power

Data and files saved on Dolphin terminals may be stored in RAM memory, which does not persist through a hard reset. Therefore, to help prevent data loss, maintain a continuous power supply to the terminal.

Letting the backup battery become fully discharged causes the terminal to lose all data in RAM. Therefore, you should keep a charged battery pack in the terminal at all times. The internal battery discharges prematurely if there is not at least a partially charged battery in the terminal. When you remove a battery pack, insert another charged battery pack in the terminal immediately.

Default Critical and Low Battery Points

When the terminal is running on battery power (as opposed to external power), warnings are displayed when the battery reaches critical and low battery points. The warning points are determined by the following registry entry:

[HKEY_LOCAL_MACHINE\ControlPanel\Power]

There are two DWORD values in this registry entry: **MedState** and **LowState**.

The default values for these entries are as follows:

MedState=25%

This sets the Low Battery point to 25%. When the battery hits the percentage charge specified here, the user is notified.

LowState=10%

This sets the Critical Battery point to 10%. When the battery hits the percentage charge specified here, the user is notified.

Note: Warnings do not appear when the terminal is on external power.

Setting Critical and Low Battery Points

Developers can reset the battery parameters in the registry from 0 (no warning) to 99 (would nearly always warn). You can review and set these battery points in the RegEdit Power Tool.

1. Tap **Start > Power Tools > RegEdit**.
2. Drill down to **HKEY_LOCAL_MACHINE > ControlPanel > Power**.
3. Tap the **Value Name** to change the Value Data.
You can reset the Value Data from 0 (no warning) to 99 (would nearly always warn).
4. Tap **OK** to save changes.

For more information about the RegEdit Power Tool, refer to the Dolphin Power Tools User's Guide available for download at www.honeywellaidc.com.

Checking Battery Power

Tap **Start > Settings > System > Power**.

Note: The Backup Battery gauge registers either 0% or 100%. The percentage is not an indication of the level of charge remaining on the backup battery. An installed and functional battery registers 100%. A total discharge or a battery error registers 0%.

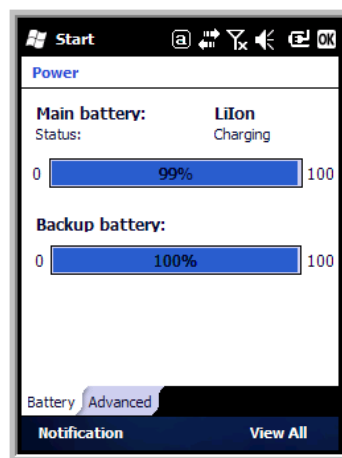

For more information, see [Power](#) on page 7-14.

Note: Tapping the battery icon at the top of the screen does not open the Power applet with this version of Microsoft Windows Mobile.



Resetting the Terminal

There are two types of system resets: a soft and a hard reset.

Soft Reset (Warm Boot)

A soft reset re-boots the device without losing RAM data. You would perform a soft reset when



- the terminal fails to respond.
- after installing some software applications.
- after making changes to certain system settings, such as network cards.

1. Press and hold the RED  + TAB  keys for approximately 5 seconds.
2. The decode and scan LEDs flash for approximately three seconds as the terminal resets.
3. When the reset is complete, the Today screen displays.

Hard Reset (Cold Boot)

A hard reset resets the operating system, restores the terminal back to factory defaults, and resets the terminal after a bootloader, keyboard, and kernel upgrade.

 *A hard reset erases all of the data stored in RAM memory and all RAM installed applications!*

1. Press and hold the RED  + ENT  keys for approximately 5 seconds.
2. The decode and scan LEDs light for approximately 3 seconds.
3. The terminal re-initializes; see [Initialize the Mobile Computer](#) on page 2-8.

Suspend Mode

The terminal goes into Suspend Mode automatically when the terminal is inactive for a programmed period of time. You can program this time on the Advance tab of the Power System Setting; see [Power](#) on page 7-14.

To put the terminal into Suspend Mode manually, press the Power key  and the screen goes blank.

To wake the terminal from Suspend Mode, press the Power key  or SCAN key .

Hardware Maintenance

When needed, clean the image engine window and the LCD display with a clean, non-abrasive, lint-free cloth. The terminal can be cleaned with a damp cloth.

For additional information on hardware maintenance specific to the Dolphin Healthcare Housings, see [page 3-11](#).



Using the Scan Image Engine

Overview

The Dolphin terminal houses a compact image engine that instantly reads popular 1D and 2D bar codes and supports omni-directional aiming and decoding for greater flexibility in real-world settings. The image engine can also capture black and white digital images, such as signatures and pictures of damaged inventory.

With the latest CMOS-based technology, the engine works like a digital camera and enables black and white digital image capture, signature capture, and reading of OCR characters.

Angled Imaging

All imagers are installed at a 33 degree downward-facing angle for enhanced comfort and maneuverability while scanning.

Image Engine Specifications

Engines	1D	2D	Image Capture	Aiming Pattern	Omni-Directional Aiming
5100SR/SF	Y	Y	Y	5300 Red High-Vis Aiming Pattern (page 4-4)	Y
5300SR	Y	Y	Y	Capturing Images (page 4-5)	Y

5100 Standard Range (5100SR) and 5300 Standard Range (5300SR)

	8.3 mil (.020 cm) Linear	10 mil (.025 cm) PDF417	13 mil (.033 cm) UPC	15 mil (.038 cm) Data Matrix	15 mil (.038 cm) QR	35 mil (.089 cm) MaxiCode
Working Range:						
Near	3.5 in. (8.9 cm)	3.1 in. (7.9 cm)	2.1 in. (5.3 cm)	2.3 in. (5.8 cm)	3.1 in. (7.9 cm)	2.0 in. (5.1 cm)
Far	7.6 in. (19.3 cm)	9 in. (22.9 cm)	13.2 in. (33.5 cm)	10.2 in. (25.9 cm)	8.8 in. (22.4 cm)	13.0 in. (33 cm)

5100 Smart Focus (5100SF)

	6.6 mil (.017 cm) PDF417	7.5 mil (.019 cm) Linear	10 mil (.025 cm) Linear	10 mil (.025 cm) PDF417	13 mil (.033 cm) UPC	15 mil (.038 cm) Data Matrix
Working Range:						
Near	2.7 in. (6.8 cm)	2.4 in. (6.1 cm)	2.1 in. (5.3 cm)	2.1 in. (5.3 cm)	1.9 in. (4.8 cm)	1.7 in. (4.3 cm)
Far	5.9 in. (14.9 cm)	6.4 in. (16.2 cm)	7.5 in. (19 cm)	7.5 in. (19 cm)	8.8 in. (22.3 cm)	7.4 in. (18.8 cm)

Laser Specifications

The maximum power outputs for each diode are as follows:

- Illumination LED: 194.0 uW
- Aimer laser (5300 engine): 360.1 uW
- Aimer LED (5100 engine): 81.6 uW

Supported Bar Code Symbolologies

Symbology Type	Symbology Name
1D Symbolologies	Codabar Code 3 of 9 Code 11 Code 32 Pharmaceutical (PARAF) Code 93 Code 128 EAN with Add-On EAN with Extended Coupon Code EAN-8 EAN-13 GS1-128 GS1 Databar Interleaved 2 or 5 ISBT 128 Matrix 2 of 5 MSI Plessey PosiCode Straight 2 of 5 IATA Straight 2 of 5 Industrial Telepen Trioptic Code UPC UPC-A UPC-E
2D Symbolologies	Aztec Codablock Code 16K Code 49 Composite Data Matrix GS1 Databar MaxiCode Micro PDF OCR PDF417 QR Code
Composite Codes	Aztec Mesa Codablock F EAN-UCC GS1 Databar-14
OCR	OCR US Money Font MICR (E 13 B) and SEMI Font OCR-A OCR-B
Postal Codes	Postnet and most international 4-state codes Australian Post British Post Canadian Post China Post Japanese Post KIX (Netherlands) Post Korea Post Planet Code

Decoding

The terminal supports two types of image decoding for use in various bar code reading and imaging applications: full-area imaging and Advanced Linear Decoding (ALD).

Full-Area Imaging

Full-area imaging provides omni-directional reading of linear and non-linear 1D and 2D bar codes, OCR, signature capture, and picture taking. When reading all bar code types using full-area imaging, a positive read can be obtained from many positions; see [Aiming Options](#) on page 4-4. To achieve the best read, the aiming beam should be centered horizontally across the bar code.

ALD

ALD provides fast reading of linear and stacked linear bar codes. To achieve a positive read when reading linear 1D and PDF417 bar codes, the green aiming beam should be centered horizontally across the bar code. When ALD is enabled, the reader does not read matrix or postal codes.

To Decode a Bar Code

The aiming beam should be oriented in line with the bar code to achieve optimal decoding. A range of 4-10 inches (10-25 cm) from the bar code is recommended.

1. Tap **Start** > **Demos**  > **Scan Demo** .
2. Point the Dolphin terminal at the bar code.

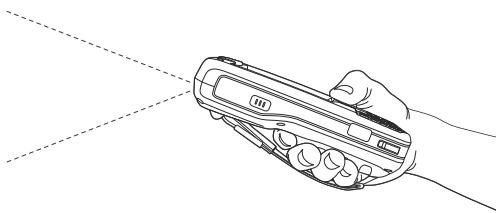

3. Project the aiming beam or pattern by pressing and holding the SCAN key .
4. The scan LED lights red.
5. Center the aiming beam over the bar code; see [Aiming Options](#) on page 4-4.
6. When the bar code is successfully decoded, the decode LED lights green and the terminal beeps.
7. The bar code information is entered into the application in use.

Aiming Options

The aiming beams are smaller when the terminal is held closer to the code and larger when it is farther from the code. Symbologies with smaller bars or elements (mil size) should be read closer to the unit whereas symbologies with larger bars or elements (mil size) should be read farther from the unit.

5300 Red High-Vis Aiming Pattern

If your Dolphin terminal is configured with a 5300 imager, high-vis aimers frame the bar code for more intuitive aiming.

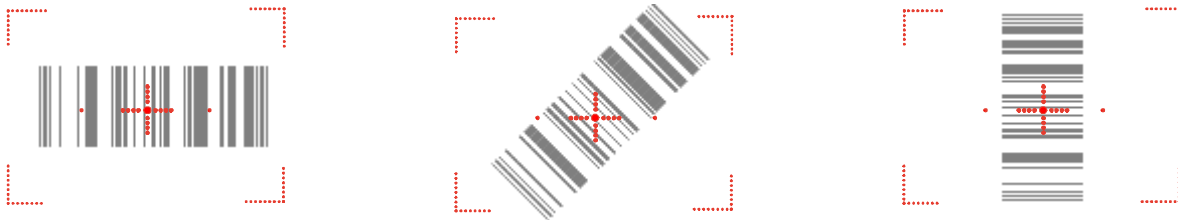

5100 Green Aiming Beam

Linear Bar Code



2D Matrix Symbol



Capturing Images

The image-capture process is an intuitive, split-second operation for experienced users. By following the basic guidelines, new users can easily develop their own technique and, with practice, quickly learn to adapt it to different application environments.

Image Preview

When the imaging process is initiated, the touch screen displays a preview of the object. This is a live video image of what the imager is currently viewing. The live video image has a slightly degraded appearance compared to the captured image. This is normal.

Scan Key

On all 9700 terminals, the SCAN key captures images.

File Formats

File formats supported for image storage include Bitmap (BMP), JPEG (JPG) and Portable Network Graphics (PNG). The default file format for images is a grayscale JPG.

Compression

Digital images have a maximum image size of 640 x 480 pixels and may have up to a 256 grayscale image definition.

The image quality and related file size are determined by the data compression method used by the software application used to take images. The average size of the image file is approximately 4–8K. However, the size of the image depends on the content of the image - the more complex the content, the larger the file size.

Taking an Image

The following steps are basic guidelines for taking images:

1. Tap **Start > Demos > Imaging Demo**.
2. Point the Dolphin terminal at the object.

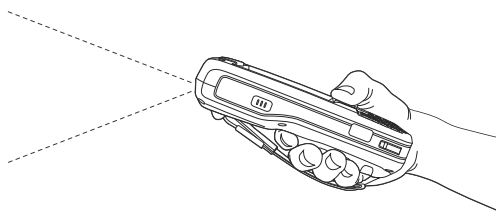

3. To preview the image, press and hold the SCAN key  .
4. The touch screen displays a preview of the object, and the decode and scan LEDs light red.
5. Adjust the terminal's position until the object appears on the screen the way you want it to appear in the image.
6. Hold the terminal still and release the SCAN key. The scan and decode LEDs flash red, the screen flashes, and the captured image appears on the screen.
7. Unless otherwise specified by the application in use, the image is saved to the **My Device\My Documents** folder (**Start > Programs > File Explorer > My Device > My Documents**).

Enabling the Aimer

If your Dolphin terminal is configured with the 5300 imager, you can enable the aiming pattern for imaging in the Imaging Demo. For details about the aimer, see [Capturing Images](#) on page 4-5.

1. Tap **Start > Demos > Imaging Demo > Setup menu > Aimer**.

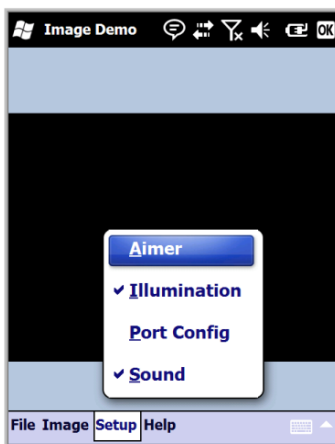

2. The aiming pattern is now enabled for imaging.

Uploading Images



Image files can be uploaded to a host workstation via Microsoft ActiveSync and a Dolphin communication peripheral or your wireless radio connection.

Using the Color Camera

Overview

All Dolphin terminals are equipped with a color camera with 2.0-Megapixels Resolution, Automated Camera Control (ACC), and an Application Programming Interface (API) that provides easy integration of color picture and video capture into business applications. The camera lens and camera flash are located on the back panel of the terminal.

Taking a picture using the Camera Demo tool

1. Tap **Start > Demos**  > **Camera Demo** 
2. Adjust the camera settings using the icon menu at the top of the display screen.

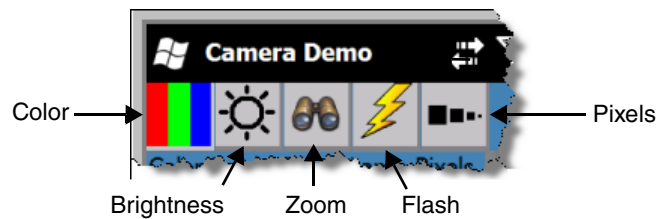

3. Point the terminal's camera lens at the object you want to capture. The camera lens is located on the back panel of the terminal.
4. Center the object in the touch screen display.
5. Press the ENT key . The terminal's red LED illuminates during picture capture.

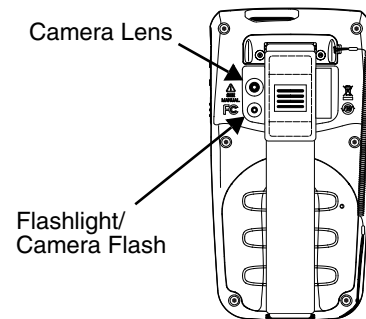

Note: Tap the green arrow  to review or edit your pictures.

Tap the green box  to exit the picture review/edit screen.



Options

Tap **Options** > **Camera**.



The Camera Options menu appears. There are five tabs of configurable options accessible from the Camera Options menu.

Profile Tab

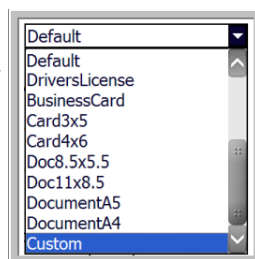
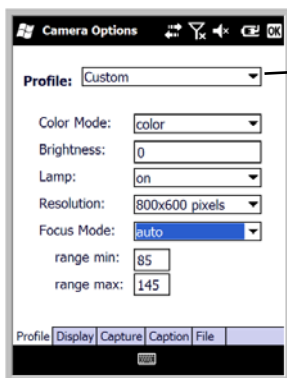

The profile tab allows you to customize your camera settings, or choose from several predefined profiles designed to provide the best picture quality for common tasks.

Display Tab

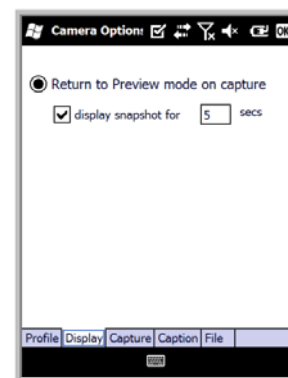

Capture Tab

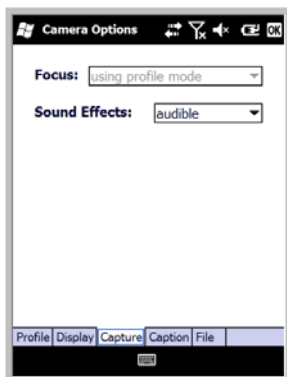

Caption Tab

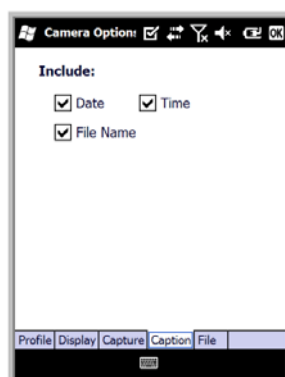

File Tab

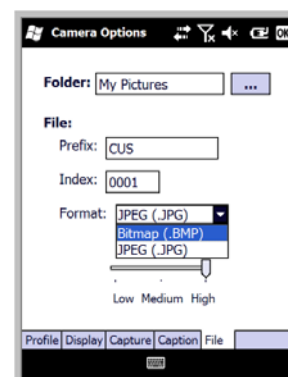

Taking a picture using the Windows Mobile 6.5 Camera tool

1. Tap **Start** > **Pictures & Videos** > **Camera**
2. Point the terminal's camera lens at the object you want to capture. The camera lens is located on the back panel of the terminal.
3. Center the object in the touch screen display.
4. Press the ENT key .
5. The touch screen displays the captured photo.

Menu

Tap **Menu** on the Command Bar to adjust the camera settings, switch to video mode, and access additional camera options.

Item	Descriptions
Video	Activate Video Mode
Mode	Normal Mode, Burst Mode, Timer Mode
Resolution	Set picture resolution (i.e., 320 x 240, 640 x 480, 800 x 600, 1600 x 1200)
Zoom	Set zoom (i.e., x1, x2, x3, and x4)
Flash	Camera Flash On or Camera Flash Off
Focus	Focus On, Focus Off, Focus on Trigger, or Fixed-Focus
Brightness	Set the brightness setting from +2.0 EV to -2.0 EV in .5 EV increments
Options	Set General, Slide Show, Camera, and Video options

Options

Tap **Menu** > **Options**. The Options menu contains four tabs:

General Tab

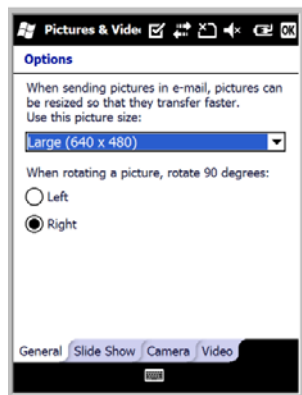

Slide Show Tab

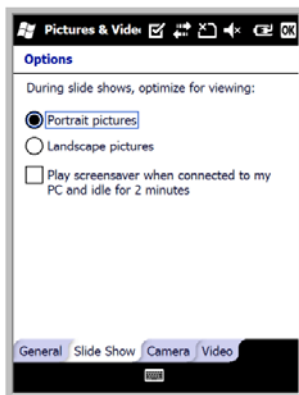

Camera Tab

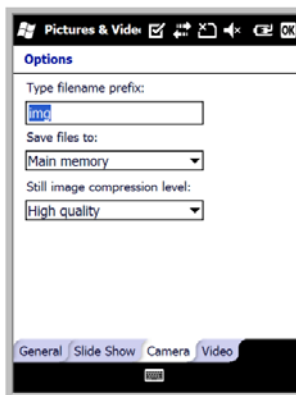

Video Tab

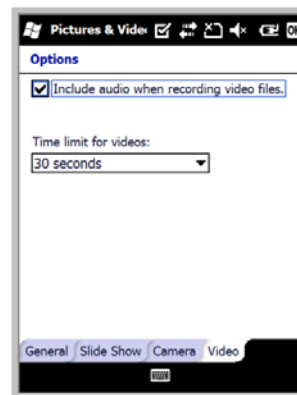

Recording Video

1. Tap **Start** > **Pictures & Videos** > **Camera** > **Menu** > **Video**
2. Point the terminal's camera lens at the object you want to capture.
3. Press the ENT key  to start recording.
4. Tap Stop or press ENT to stop recording.



Using the Keyboards

Available Keyboards

There are two keyboard options in the 9700 series:

31-Key Numeric Keyboard

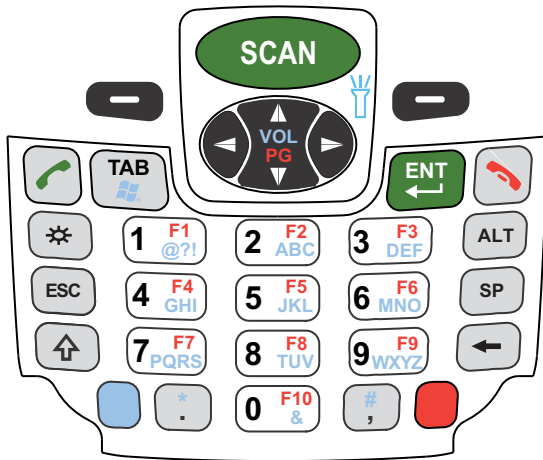

45-Key QWERTY Keyboard

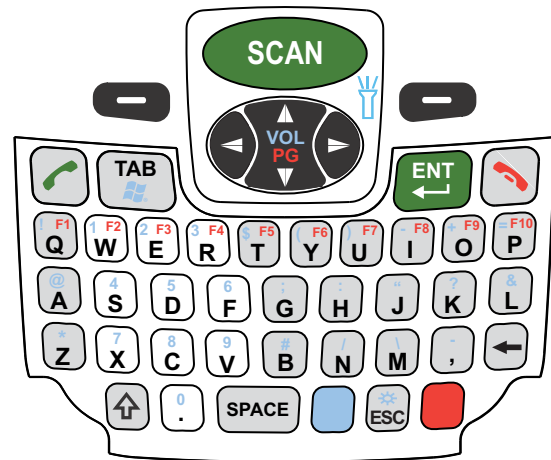

All Keyboards Contain the Following:

- Backlit for easy viewing in various lighting conditions.
- Centrally located Scan key for both right- and left-hand operation.
- Color-coding so you can clearly see the most common keyboard combinations.
- Function, navigation, and modifier keys.

Keyboard Combinations

See [31-Key Keyboard Combinations](#) on page 6-4.

See [45-Key Keyboard Combinations](#) on page 6-6.















Common Buttons

See [Using the Function Keys](#) on page 6-2.



See [Using the Modifier Keys](#) on page 6-3.

See [Using the Navigation Keys](#) on page 6-3.

Using the Function Keys







Name	Key	Function
Backlight	 Numeric Keyboard	Turns the keyboard backlight on and off.
	 &  Blue QWERTY Keyboard	
Backspace		Moves the cursor back one space each time the key is pressed. If you are typing text, it deletes the previous character each time it is pressed.
Enter (ENT)		Confirms data entry.
Escape (ESC)	 Numeric Keyboard	Cancels the current action.
	 QWERTY Keyboard	
Power Key		Puts the terminal in and wakes the terminal from Suspend Mode; see Suspend Mode on page 3-15.
SCAN Key		Activates the scan and “wakes” the terminals from Sleep Mode. Its position allows convenient one-handed image-taking and/or bar code decoding.
	 &  Blue	Turns the flashlight on and off. The flashlight is located on the back panel of the terminal.
Space (SP)	 Numeric Keyboard	Moves the cursor one space.
	 QWERTY Keyboard	
Tab		Moves the cursor to the next tab stop or the next control (on a form).

Using the Modifier Keys

Name	Key	Function
Shift		<p>The shift key modifies only the next key pressed; it must be pressed before each key you wish to modify. Shift toggles the keyboard between uppercase alphabet mode and lowercase alphabet mode.</p> <p>Press the shift key twice to toggle Caps Lock on and off. When Caps Lock is toggled on, characters are uppercase; when toggled off, characters are lowercase.</p>
Blue and Red	 Blue  Red	<p>The blue and red keys are used in combination with other keys to type special characters and perform system functions. Each key modifies only the next key pressed.</p> <p>Each keyboard is color-coded to indicate the character typed or function performed when specific keys are pressed immediately after the blue or red modifier key.</p> <p>Press the blue key twice to toggle the modifier key on or off. When the modifier key is toggled on, you can enter multiple blue characters or functions without having to press the modifier key before each key input.</p>

Using the Navigation Keys

Located in the center of each keyboard for easy access with either hand, the navigation keys navigate the cursor through application screens.

Key	Function
	<p>Moves the cursor up one row or line. OR Moves the cursor down one row or line.</p>
 & 	<p>Moves the cursor up one page. OR Moves the cursor down one page.</p>
 & 	<p>Raises the volume. OR Lowers the volume.</p>
	Moves the cursor one character to the right.
	Moves the cursor one character to the left.

Note: Additional functionality varies according to the application in use.

31-Key Numeric Keyboard

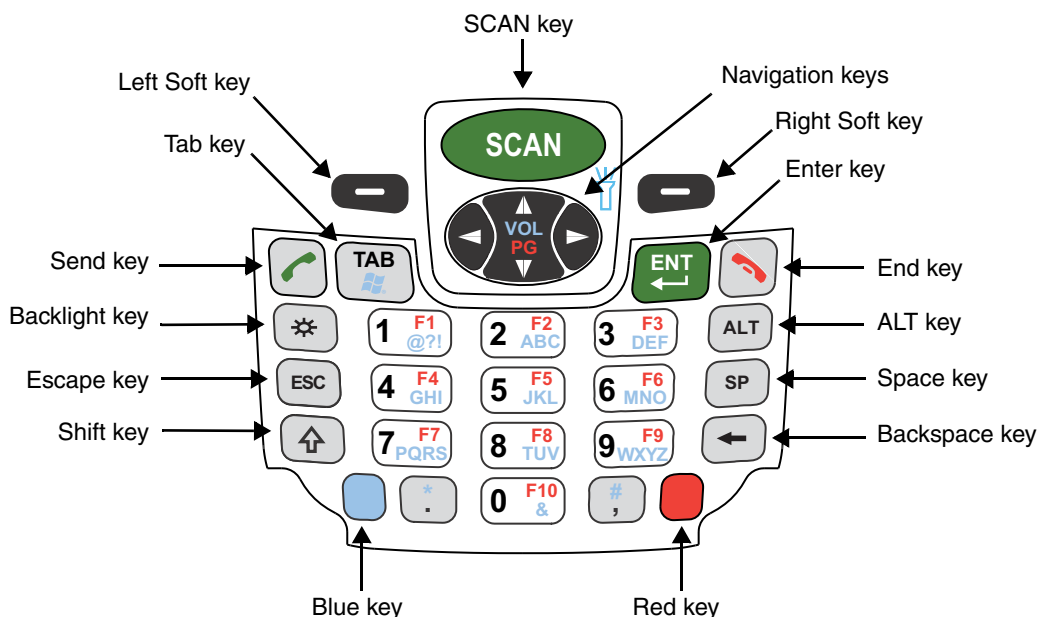

31-Key Keyboard Combinations

Key	Normal	Shift	Blue	Shift-Blue	Blue-Lock	Red
Power	Off/On					
Scan	Scan	Scan	Flashlight Off/On	Flashlight Off/On	Scan	Scan
Left Soft	Perform Left Function		Perform Left Function		Perform Left Function	
Right Soft	Perform Right Function		Perform Right Function		Perform Right Function	
Left	Left	Left	Left	Left	Left	Left
Up	Up	Up	Volume Up	Volume Up	Up	Prior
Down	Down	Down	Volume Down	Volume Down	Down	Next
Right	Right	Right	Right	Right	Right	Right
Send	Send (phone calls)	Send (phone calls)	Send (phone calls)	Send (phone calls)	Send (phone calls)	Send (phone calls)
TAB	Tab	Tab	LWIN	LWIN	Tab	Tab
Enter	Return	Return	Return	Return	Return	Return

Key	Normal	Shift	Blue	Shift-Blue	Blue-Lock	Red
End	End (phone call)	End (phone call)	End (phone call)	End (phone call)	End (phone call)	End (phone call)
Backlight	Toggles Keyboard Backlight On/Off					
ESC	Escape	Escape	Escape	Escape	Escape	Escape
SHIFT	Shift		Shift		Shift	
1	1	!	@,?,!	@,?,!	@,?,!	F1
2	2	@	a,b,c	A,B,C	a,b,c	F2
3	3	#	d,e,f	D,E,F	d,e,f	F3
4	4	\$	g,h,i	G,H,I	g,h,i	F4
5	5	%	j,k,l	J,K,L	j,k,l	F5
6	6	^	m,n,o	M,N,O	m,n,o	F6
7	7	&	p,q,r,s	P,Q,R,S	p,q,r,s	F7
8	8	*	t,u,v	T,U,V	t,u,v	F8
9	9	(w,x,y,z	W,X,Y,Z	w,x,y,z	F9
0	0)	&	&	&	F10
ALT	Menu	Menu	Menu	Menu	Menu	Menu
Space	Space	Space	Space	Space	Space	Space
BKSP	Backspace	Backspace	Backspace	Backspace	Backspace	Backspace
Blue	Blue				Blue	
Period	. (period)	>	* (multiply)	* (multiply)	* (multiply)	. (period)
Comma	, (comma)	<	#	#	#	, (comma)
Red	Red					Red

45-Key QWERTY Keyboard

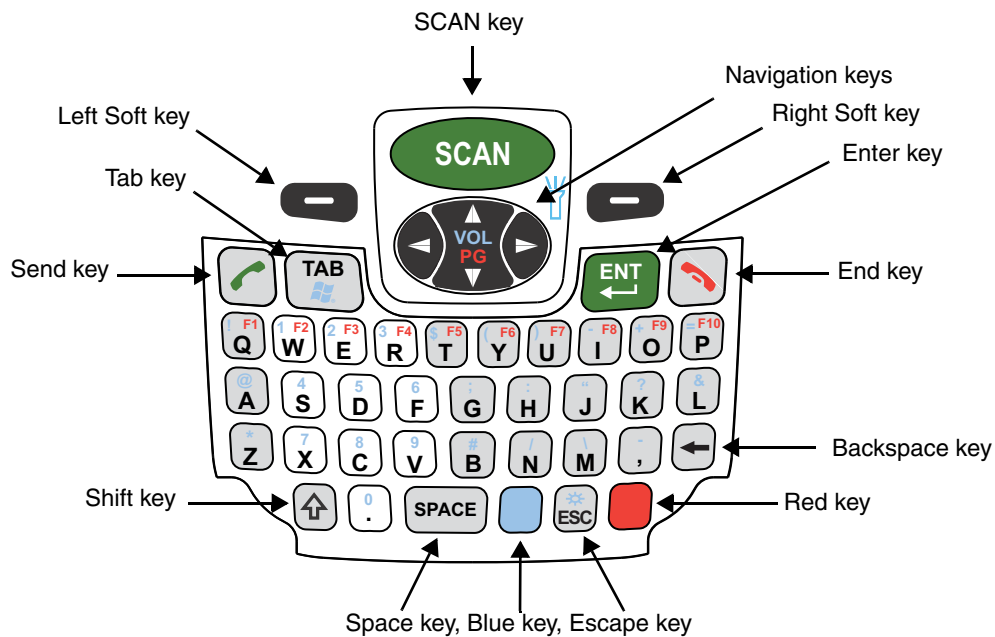

45-Key Keyboard Combinations

Key	Normal	Shift	Blue	Blue-Lock	Red
Power	Off/On				
Scan	Scan	Scan	Flashlight Off/On	Scan	Scan
Left Soft	Perform Left Function		Perform Left Function	Perform Left Function	
Right Soft	Perform Right Function		Perform Right Function	Perform Right Function	
Left	Left	Left	Left	Left	Left
Up	Up	Up	Volume Up	Up	Prior
Down	Down	Down	Volume Down	Down	Next
Right	Right	Right	Right	Right	Right
Send	Send (phone calls)	Send (phone calls)	Send (phone calls)	Send (phone calls)	Send (phone calls)
TAB	Tab	Tab	LWIN	Tab	Tab
Enter	Return	Return	Return	Return	Return
End	End (phone call)	End (phone call)	End (phone call)	End (phone call)	End (phone call)

Key	Normal	Shift	Blue	Blue-Lock	Red
ESC	Escape	Escape	Backlight	Escape	Escape
SHIFT	Shift				
A	a	A	@	@	F11
B	b	B	#	#	F24
C	c	C	8	8	F22
D	d	D	5	5	F13
E	e	E	2	2	F3
F	f	F	6	6	F14
G	g	G	;	;	F15
H	h	H	:	:	F16
I	i	I	- (subtract)	- (subtract)	F8
J	j	J	“	“	F17
K	k	K	?	?	F18
L	l	L	&	&	F19
M	m	M	\	\	F26
N	n	N	/	/	F25
O	o	O	+ (add)	+ (add)	F9
P	p	P	=	=	F10
Q	q	Q	!	!	F1
R	r	R	3	3	F4
S	s	S	4	4	F12
T	t	T	\$	\$	F5
U	u	U))	F7
V	v	V	9	9	F23
W	w	W	1	1	F2
X	x	X	7	7	F21
Y	y	Y	((F6
Z	z	Z	* (multiply)	* (multiply)	F20
Space	Space	Space	Space	Space	Space
BKSP	Backspace	Backspace	Backspace	Backspace	Backspace







Key	Normal	Shift	Blue	Blue-Lock	Red
Blue	Blue			Blue	
Period	. (period)	>	0	0	. (period)
Comma	, (comma)	<	_ (underscore)	_ (underscore)	F27
Red	Red				



System Settings

Overview

Customized settings are available on the Start menu. Tap **Start > Settings** and the settings screen opens.



Icon		Description
Bluetooth		Configures the Bluetooth radio. This icon appears only if a Bluetooth radio and driver are installed on the terminal. See Working with the Bluetooth Radio on page 10-1.
Clock & Alarms		Set the system clock, date, time and schedule alarms. See Clock & Alarms on page 7-2.
Lock		Password protect the terminal to limit access to the terminal.
Sounds & Notifications		Set the sound volume, enable or disable sounds for specific actions, set sound parameters for system notifications and enable or disable vibrator notification.
Today		Customize the look and the information displayed on the Today screen.
Connections		Establishes network connections settings. See Connections Menu on page 8-1.

Icon		Description
Personal		Customizes buttons, and set SIP options. See Personal Menu on page 7-3.
System		Adjusts system settings. See System Menu on page 7-7.
Microsoft My Phone		Synchronizes your phone's contacts, calendar, tasks, text messages, music, photos, videos, and other documents with your My Phone account at http://myphone.microsoft.com .

Clock & Alarms

The Clock & Alarms settings can be accessed from the Today screen or the Settings Menu.

1. On the Today screen, tap the line that displays the time and date

OR

Tap **Start > Settings > Clock & Alarms**,

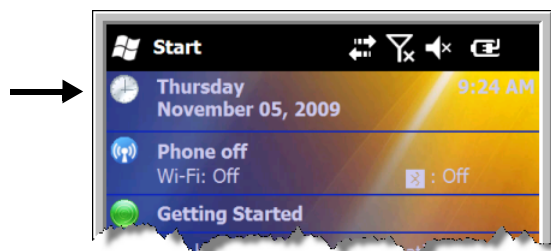

2. The Clock Settings screen appears. This setting sets the system clock. All scheduled items run according to this setting.







Tap the arrow to the right of the time zone to open the drop down menu. Select the appropriate time zone from the menu. Set the correct time and date in the remaining fields and tap **OK** to save.

Personal Menu

To access the Personal Menu, go to **Start > Settings > Personal**. The screen opens displaying the Personal Menu.



Icon	Description
Buttons 	Program the side buttons to perform specific tasks. See Buttons on page 7-4.
Input 	Customizes the SIP (soft input panel). See Input on page 7-5.
Owner Information 	Enter your contact information. This information will appear on the Today screen.
Phone 	When the GSM radio is enabled, tap this icon to set up user parameters. See Setup Options on page 9-7.

Note: Personal settings are stored in RAM memory. They are replaced by system defaults after each hard reset. For more information about resets, see [Resetting the Terminal](#) on page 3-15.

Buttons

The Buttons setting programs certain keyboard buttons to launch applications or execute commands.

Enable HotKeys

Default Buttons setting assignments are inactive until you enable the HotKeys Power Tool.

Tap **Start > Power Tools** and tap the HotKeys icon  **once**. HotKeys is enabled, and the button assignments in the Buttons setting are active.

For more information about the HotKeys Power Tool, refer to the Dolphin Power Tools User's Guide, which is available for download from the web at www.honeywellaidc.com.

Changing Button Assignments

1. After HotKeys is enabled, tap **Start > Settings > Personal**  **> Buttons** .

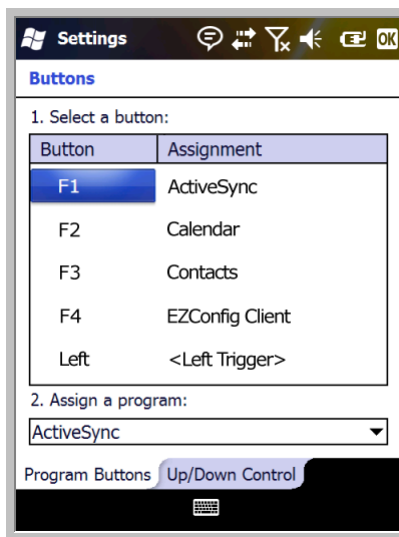

Note: The buttons that appear on this window are the only buttons that can be programmed via the Buttons setting. You cannot add buttons to this window.

2. To change button assignment, tap on the name of the application in the **Assignment** column and select a program or command in the **Assign a program** drop down list.
3. Tap **OK** to save.
4. Press the button to verify that the program is launched or action performed.

Available Applications

The **Assign a program** list contains the applications installed on the terminal. If there is a program installed that you would like to see in this list, paste a Shortcut to the program in the **\\Windows\Start Menu\Programs** folder. For instructions about creating shortcuts, see [Using File Explorer](#) on page 7-6.

Additional Functions

The **Assign a program** list also contains the following commands:

Command	Description
<Context Menu>	Performs the same function as tap-and-hold to open the context menu for the control.
<Input Panel>	Opens the soft input panel.
<Left Softkey>	Opens the menu or performs the action displayed on the left side of the Command bar.
<None>	Nothing happens when the button is pressed.
<OK/Close>	Performs the same function as tapping OK on the screen.
<Right Softkey>	Opens the menu or performs the action displayed on the right side of the Command bar.
<Right Trigger>	Activates the scanner/imager.
<Rotate Screen>	Changes the screen orientation from portrait to landscape.
<Scroll Down>	Scrolls down in the open application.
<Scroll Left>	Scrolls left in the open application.
<Scroll Right>	Scrolls right in the open application.
<Scroll Up>	Scrolls up in the open application.
<Start Menu>	Opens the Start menu.
<Today>	Opens the Today screen.

Input

The Input settings enables you to customize input from the SIP, and adjust word completion settings in Microsoft applications.

Input Method

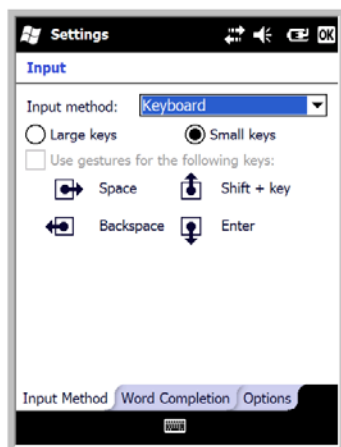

Word Completion

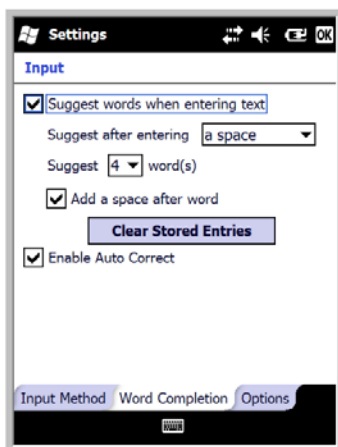

Options

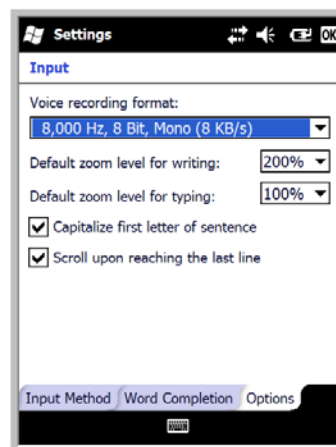

Using File Explorer

If you do not see the program listed, you can either use File Explorer to move the program or ActiveSync on the workstation to create a shortcut to the program and place the shortcut in the Start Menu folder.

Note: We recommend that you Copy and Paste Shortcut so that you do not alter your program configurations by accident. Using Copy and Paste Shortcut (as opposed to Cut and Paste) ensures that the program files remain where they need to be for the system to find them to perform system functions.

1. Tap **Start > File Explorer** , and navigate to the program (**My Device > Program Files**).

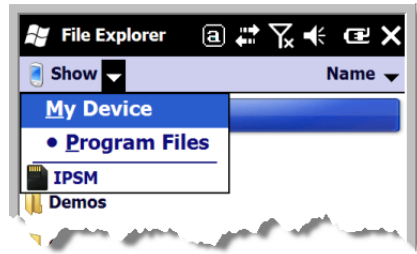

2. Tap and hold on the program, then tap **Copy** on the pop-up menu.
3. Navigate to the Windows folder and open the Start Menu (**My Device > Windows > Start Menu**), tap and hold a blank area of the window, and tap **Paste Shortcut** on the pop-up menu.

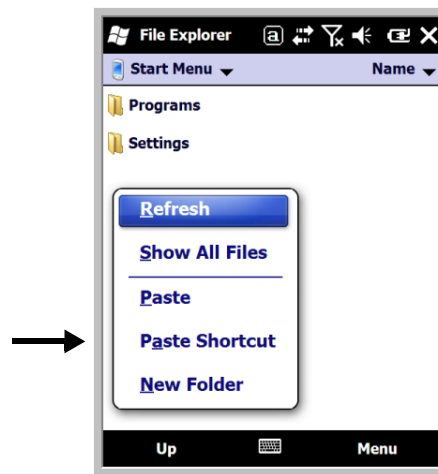

*Note: If there is no blank space available in the window, tap on **Menu > Edit > Paste Shortcut**.*

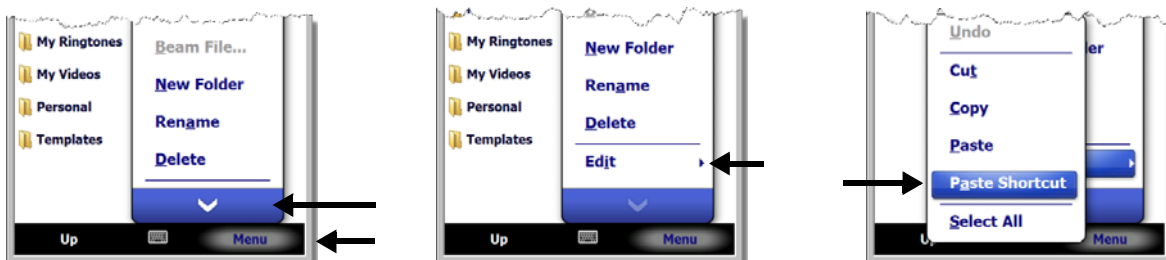

4. Tap the **Start** menu to verify that the program now appears on it.

Using ActiveSync on the Workstation





Here, you are performing the same basic process as on the terminal, except that you are using the Explore utility (Windows Explorer) to copy and paste the shortcut.











1. Open **ActiveSync > Explore** and navigate to the program.
2. Right-click on the program and select **Create Shortcut**.
3. Select the shortcut, right-click, and select **Cut**.
4. Navigate to the **Start Menu** folder (Windows > Start Menu).
5. Right-click on an empty area and select **Paste Shortcut**.
6. On the terminal, tap the **Start** menu.
7. Verify that program appears.

System Menu

The System menu enables you to verify and sometimes alter system parameters. To access the System menu, go to **Start > Settings > System**. Tap the appropriate icon to open that system setting.



Icon		See Page
About		See About on page 7-8.
Backlight		See Backlight on page 7-9.
Certificates		See Certificates on page 7-10.
Encryption		See Encryption on page 7-10.

Icon		See Page
Error Reporting		See Error Reporting on page 7-10.
External GPS		See External GPS on page 7-11.
Managed Programs		See Managed Programs on page 7-11.
Memory		See Memory on page 7-12.
Power		See Power on page 7-14.
RIL		See RIL on page 7-13.
Regional Settings		See Regional Settings on page 7-14.
Remove Programs		See Remove Programs on page 7-14.
Screen		See Screen on page 7-16.
Task Manager		See Task Manager on page 7-17.

About

The About system setting displays specific information about the terminal. It contains three tabs:

Version Tab Displays the information about the software, operating system, and processor.

Device ID Tab Displays the information the terminal uses to identify itself to other devices. It can be important to know this information if the Dolphin terminal is going to be part of a networked system of devices.

Device name: Displays the system's default name. (This is the name used by ActiveSync.)

Description: Displays the description of the device ID.

Copyrights Tab Displays important copyright information.

Backlight

The Backlight system setting enables you to customize backlight functionality for the display. The backlight for the color display is user-defined. Tap **Start > Settings > System > Backlight**.

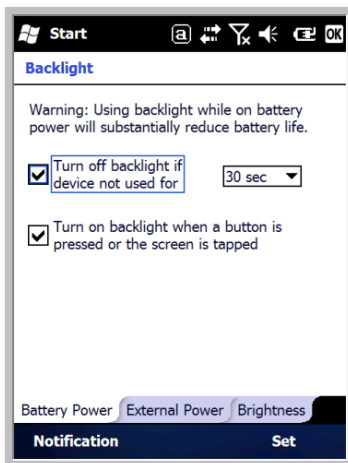

There are two tabs:

The **Battery** tab determines the backlight timeout when the terminal is running on battery power.

The **External** tab determines the backlight timeout when the terminal is running on external power.

The options on each tab are the same.

Turn off backlight: Select how many minutes you want to elapse before the backlight automatically turns off.

Turn on backlight: Select this option if you want the backlight to turn on when the button is pressed or the touch screen is tapped.

Backlight Intensity

Tap the **Backlight** tab and move the slider to set the intensity of the backlight. The default is 4.

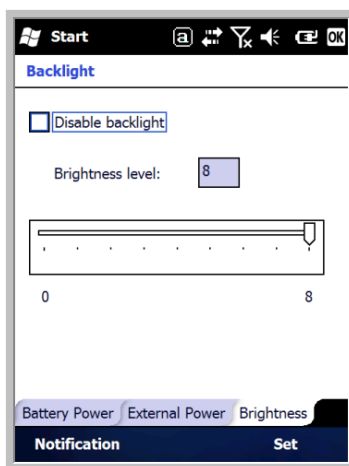

Certificates

Certificates shows you the certificates that are recognized by the operating system.

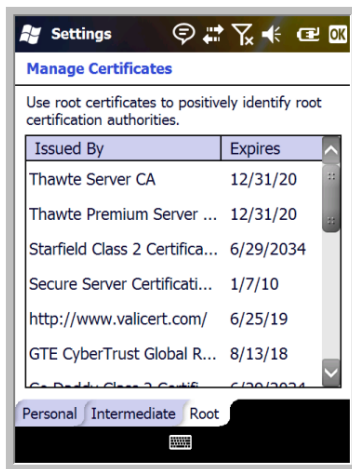

Encryption

Encryption gives you the option of encrypting files placed on storage cards so that those files cannot be read by any other device.



Error Reporting

Error Reporting gives you the option of enabling or disabling the error reporting function of Windows Mobile 6.5.

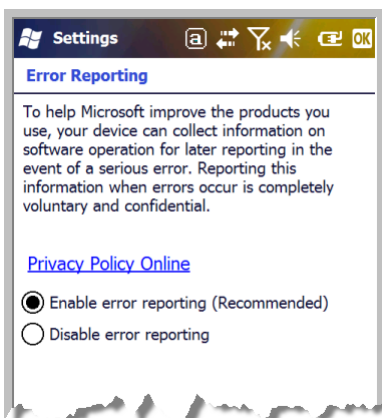

External GPS

External GPS determines which port a third-party GPS software application can use to access the GPS receiver.

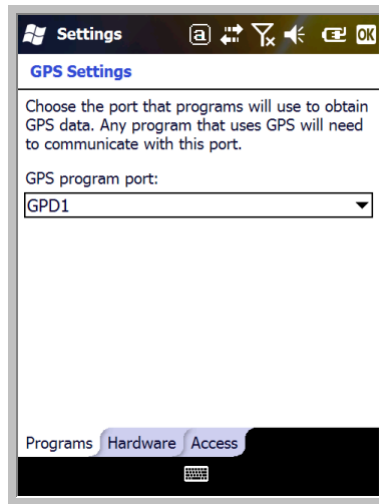

Note: You need the installation parameters from the GPS manufacturer to configure the connection.

Managed Programs

Managed Programs are a list of programs that are managed if enrolled to enterprise domain. Managed Programs is the client-side that works with the server product System Center Mobile Device Manager (MDM). MDM consists of MDM Gateway Server and one or more computers that run MDM Device Management Server; MDM Enrollment Server; and Microsoft SQL Server® 2005 databases.

It lets system administrators:

- provide an authenticated connection to LOB applications, managed Group Policy, and application packages.
- use Group Policy and software packages to manage the enrolled Windows phones (enforce policy, wipe devices, etc.).
- manage the requests for and retrieving of certificates for devices and for creating the Active Directory® Domain Service objects that represent these devices. By using these objects, you can manage the devices as if they were members of a domain.

Memory

The Memory system setting displays capacity and usage statistics for both RAM (volatile) and IPSM/ Storage Card (non-volatile) memory. Access this setting whenever you receive system messages about memory.

You cannot change the terminal's memory allocation in the Memory system setting. To change the memory allocation, you need to use the SetRAM Power Tool (Start > Power Tools > SetRAM). For more details, please refer to the Honeywell Power Tools User's Guide, which is available for download from www.honeywellaidc.com.

There are two tabs: Main and Storage Card.

Main Tab

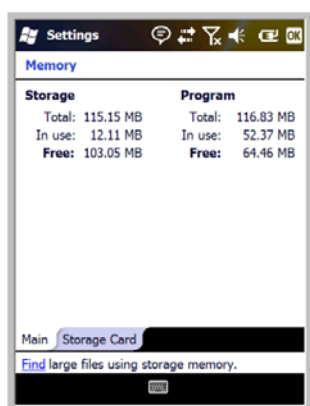

This tab displays the usage statistics of the on-board, volatile RAM memory.

Columns:

Storage=RAM memory used to store programs and program data.
Program=RAM memory used to run programs.

Rows:

Total=Displays the current MB of memory allocated for use.
In use=Displays the total MB of that allocated memory being used.
Free=Displays the total MB of memory available.

Storage Card Tab

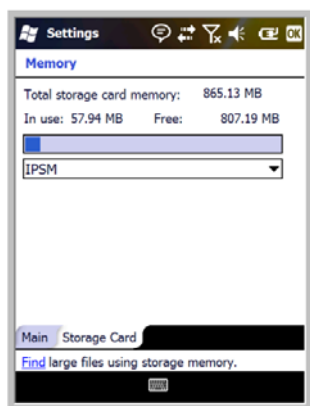

This tab displays the current capacity and usage statistics of the selected memory type: IPSM or Storage Card.

Select the memory type from the drop-down list. IPSM is selected by default.

Total storage card memory=
The total MB of memory capacity of IPSM or Storage Card.
In use=The MB currently being used.
Free=The MB that is still available for use.

IPSM—Short for Internal Persistent Storage Manager, this is the on-board Flash memory that is non-volatile. Because this memory is non-volatile, data or programs stored in IPSM are not affected when power is removed. Autoinstall programs, for example, are stored in IPSM so that they are always installed at cold-boot startup.

Storage Card—You can install one memory card in Dolphin terminals (see [Installing a Memory Card](#) on page 3-9). If a storage card is installed in the terminal, you can select it in the drop-down list and see capacity and usage statistics for the card.

RIL

The RIL Information screen displays useful statistics for the radio.

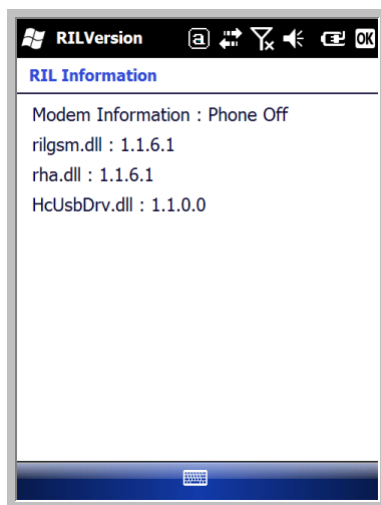

To verify whether or not the GSM radio is enabled, check the [Dolphin Wireless Manager](#) (see page 8-5).

Power

Power system settings contains two tabs: Battery and Advanced.

Battery Tab

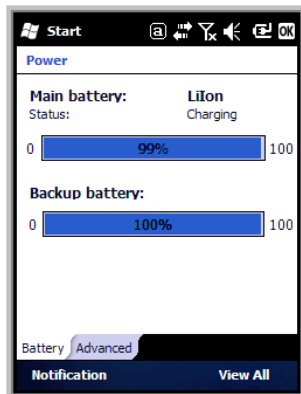

For more information, see [Batteries](#) on page 3-12.

Note: The Backup Battery gauge registers either 0% or 100%. The percentage is not an indication of the level of charge remaining on the backup battery. An installed and functional battery registers 100%. A total discharge or a battery error registers 0%.

Advanced Tab

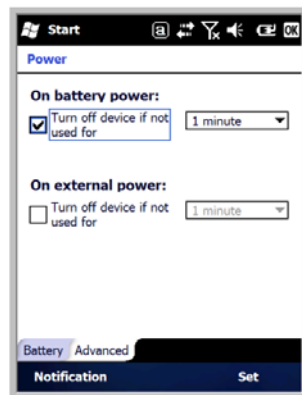

Determines power time-outs.

For **On battery power**, select from the drop-down list, the number of minutes of inactivity you want to pass before the terminal powers off when running on battery power.

For **On external power**, select from the drop-down list, the number of minutes of inactivity you want to pass before the terminal powers off when running on external power.

Note: You can also set automatic turn-off times for the terminal to conserve power. When the terminal is “turned off,” that means that it goes into Suspend Mode, see [Suspend Mode](#) on page 3-15.

Regional Settings

Regional Settings enables you to customize the appearance and formatting to your geographic region. Specifically, you can customize numbers (i.e., number of decimal places allowed), currency (i.e., using the \$ or € symbol), time, and date. These specifications apply to all screens, including the Today screen. The Region tab displays an overview of the region selected in the drop-down list at the top.

The terminal is loaded with a number of pre-programmed regional settings. Select one from the list and the results appear on the screen. To see specific settings or to change a specific setting, tap on one of the tabs, make the change, and tap **OK** to save it.

Remove Programs

Remove Programs enables you to remove programs installed on the terminal. Use this setting to troubleshoot when you receive messages that the terminal is out of memory. The programs removed are removed from RAM memory. Any program (usually CAB or DLL files) stored in the Autoinstall folder (**My Device > IPSM > Autoinstall**) will re-install after the next hard reset.

For information about the hard reset process, see [Hard Reset \(Cold Boot\)](#) on page 3-15.

1. Tap **Remove Programs**. In the list, select the program you want to remove.

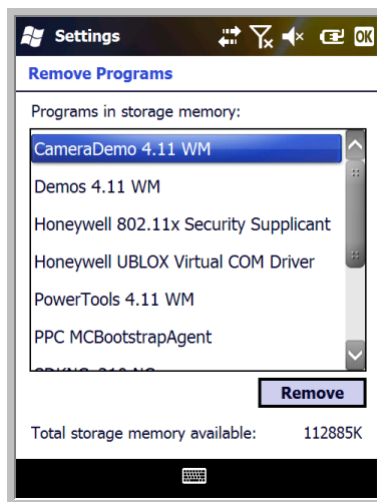

2. Tap **Remove**. The following message appears:

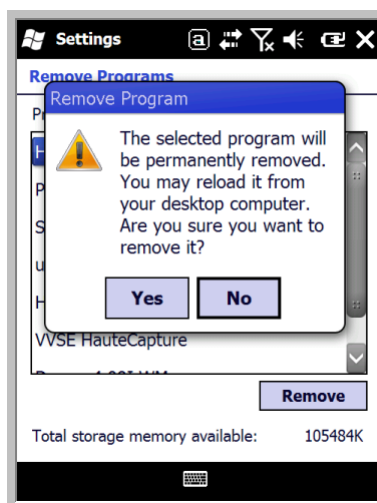

3. Tap **Yes**. Wait while the program is removed.
4. Verify that the program no longer appears in the list.

Screen

The Screen system setting contains three tabs: General, Clear Type, and Text Size.

General Tab

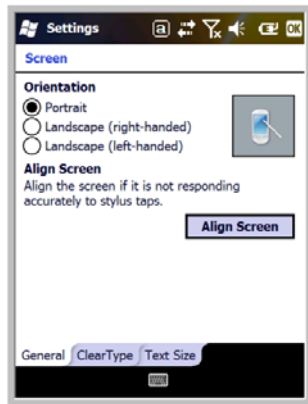

Orientation

The General Tab enables you to set the dynamic screen rotation. Three choices of screen orientation are supported: Portrait, Landscape (right-handed), and Landscape (left-handed).

Align Screen

The General Tab also allows you to re-align the screen. You need to re-align the screen if tapping buttons or icons with the stylus no longer seems to work appropriately.

Tapping **Align Screen** brings up the align screen window where you are guided to tap a target several times. This recalibrates how the touch screen receives input.

- Alignment should always be performed with a stylus designed for touch panel applications. The small point is required for accurate calibration.
- Press the stylus firmly into the center of the cross-hair target once and release. Do not “double-tap” the target.

ClearType Tab

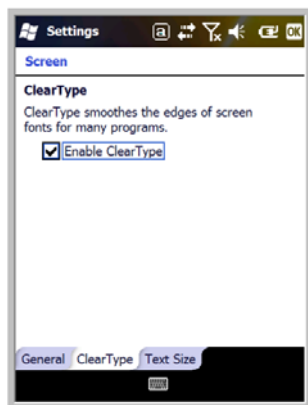

The display supports ClearType font rendering, which is a Microsoft technology that dramatically increases the readability of text on LCD displays.

To enable ClearType font rendering, select **Enable ClearType** and tap **OK**.

For more information about ClearType font rendering, visit: www.microsoft.com/typography/WhatIsClearType.mspx.

Text Size Tab

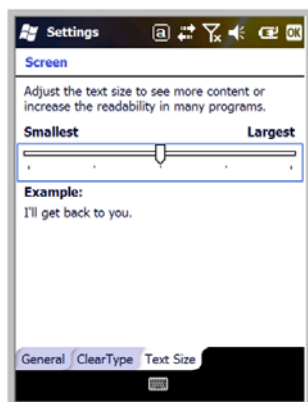

The Text Size tab enables you to perform font scaling within certain views of the;

- Today screen,
- Contacts,
- Calendar,
- Messaging, and
- Tasks.

Font scaling means that you can increase or decrease the point size of the font on application windows.

To change the font size, move the slider toward **Smallest** or **Largest**. The Example text changes to reflect the font change. Tap **OK** to save the new font size setting.

Task Manager

The Task Manager provides information about applications and processes running on your mobile computer. You can use the Task Manager to monitor the memory and CPU usage of specific applications and processes. Check the Task Manager when you are receiving out of memory errors or when the mobile computer is running slowly.

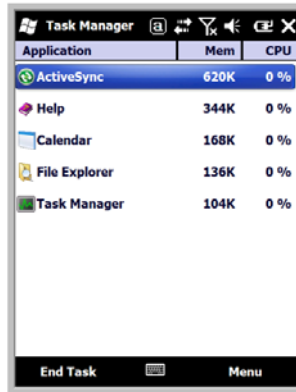

Using the Task Manager

Applications

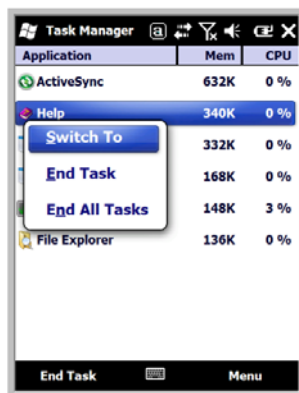

To view the status of the programs running on your mobile computer, tap the **Menu** button at the bottom of the screen, then tap **View > Applications**.

From the application list, you can:

- Tap and hold on an application, then tap **Switch To** on the pop-up menu.
- Tap and hold on an application, then tap **End Task** or **End All Tasks** on the pop-up menu.

Note: Anytime you stop a running program, it frees up RAM memory. Be advised that, when you stop a program here, any unsaved data in that program is lost. To free up memory without risking data loss, return to the running program, save your data, and close the application.

Processes

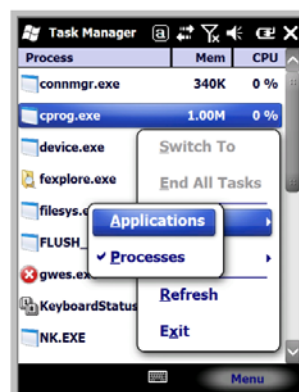

To view information about the processes running on the mobile computer, tap the **Menu** button at the bottom of the screen, then tap **View > Processes**.







Communication

Connections Menu

The Connections system setting provides access to the terminal's various wireless communication options.



Icon		Tapping this icon...
Beam		Enables infrared communication. See Receiving Data on page 8-3.
Connections		Opens Microsoft's connections manager. See Connections Manager on page 8-4.
Dolphin Wireless Manager		Manages the wireless radios installed in the terminal. See Dolphin Wireless Manager on page 8-5.
USB to PC		Enables advanced wired USB to PC communication via ActiveSync. See ActiveSync Communication on page 8-8.
Wi-Fi		Enables you to configure Wireless Zero Config (WZC). This icon appears only if the 802.11 a/b/g driver is loaded on the terminal and the Honeywell WLAN Security Supplicant is not loaded. By default, the Wireless Zero Config is disabled and the supplicant is loaded. This icon appears only if you removed the supplicant and cold booted the terminal.

Note: All server-assigned IP addresses use Dynamic Host Configuration Protocol (DHCP).

Using the IrDA Port

Using the IrDA port, you can send and receive data between the terminal and other devices equipped with infrared. This can include, but is not limited to, Windows Mobile information such as Contacts and Tasks, as well as software upgrades.

IrDA Port Location

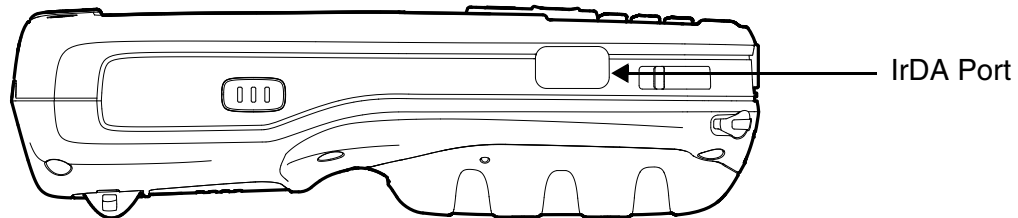

To send or receive, the IrDA ports of both devices - whether it is two terminals, or a terminal and a host device - must be aligned with each other and within a close range. The maximum data transfer speed is 115 Kbps.

Sending Data

1. Align the IrDA ports.
2. Open the program where you created the item you want to send and locate the item in the list. You can also beam files, but not folders, from File Explorer.
3. Tap and hold the item and select **Beam File**.

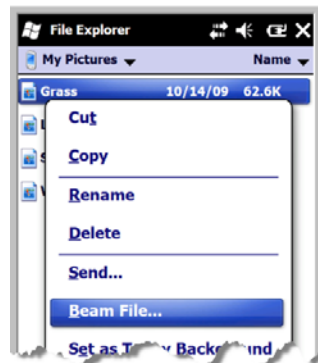

4. The IrDA port searches for a receiving IrDA port in the vicinity. The selected device reads "Pending."

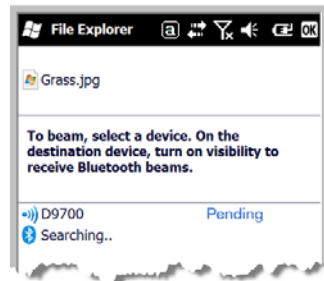

-
- When the IrDA port finds the aligned IrDA port, it immediately starts sending the selected file. The selected device reads "Sending."



- When the file transfer is complete, the selected device reads "Done."

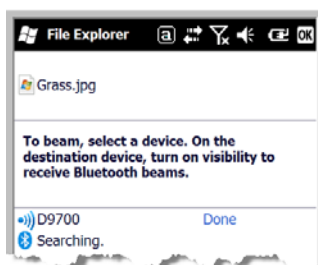

Receiving Data

The Beam Setting must be set to receive all incoming beams from other infrared devices.

- Verify that beam settings are set to receive. Tap **Start > Settings > Connections > Beam**. The Beam Settings window should appear as follows:

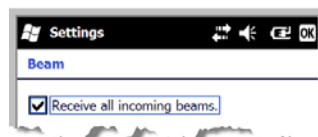

- Align the IrDA ports.
- Have the owner of the other device send the information to you.
- Your terminal automatically begins receiving it.

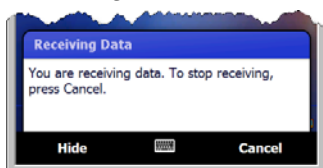

- A popup message appears asking if you want to save the incoming file.



- Tap **Yes** to receive the file.

Connections Manager

Microsoft's Connections Manager sets up multiple network connections to Internet Service Providers (ISPs) via external modem.

Do NOT enter connection parameters in the Connections Manager if:

- You are using one of the on-board wireless radios to connect to a network.
The Dolphin terminal uses the settings from each radio's configuration utility to connect.
- You are using Wireless Zero Config. By default, WZC is disabled on Dolphin terminals.

To Access the Connections Manager

Tap **Start** > **Settings** > **Connections** > **Connections** icon .

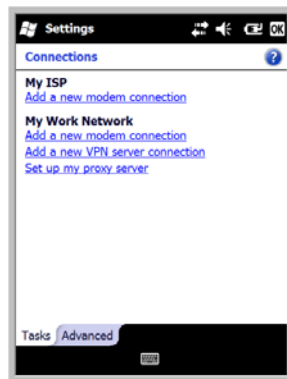

Task Tab

The Task tab enables you to initially configure, and then manage network settings when using a modem. Select an item in this list and then complete the setup screens that follow with the appropriate information for your network.

My ISP

The links under this heading enables you to add and manage modem connections to an ISP. To complete the setup screens, obtain the following information from your ISP:

- ISP dial-up access telephone number
- Username
- Password
- TCP/IP settings

My Work Network

These links enable you to establish the following connections types:

- Modem
- Virtual Private Network (VPN)
- Proxy server connection

Note: If you are connected to your ISP or private network during synchronization, the terminal should download the proper proxy settings during synchronization with the PC. If these settings are not on your PC or need to be changed, ask your ISP or network administrator for the proxy sever name, server type, port, type of Socks protocol used, and your user name and password.

To complete the setup screens, obtain the network parameters from your system administrator.

Modify an Existing Connection

Manage Existing Connections appears on the Connections tab after at least one network connection has been established.

Tap **Manage Existing Connections** on the Tasks tab and follow the setup screens.



Advanced Tab

The Advanced tab enables you to select the default network, dialing rules, and IP address exceptions for modem connections.

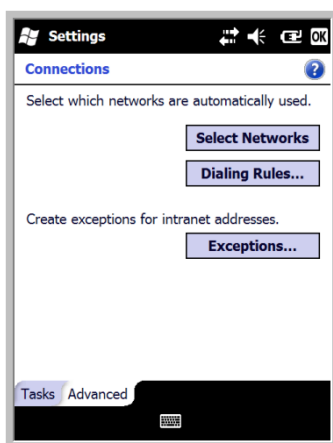

Note: You should not need to change Advanced settings because most ISPs now use DHCP addresses.

Online Help

For more information about modem connection setup, consult the online help on the setup screens by tapping the Help icon .

Dolphin Wireless Manager

The Dolphin Wireless Manager provides a centralized interface that enables and disables all the on-board radios. Each radio has its own configuration program. The Dolphin Wireless Manager also provides shortcuts to the configuration utilities for each radio.

Dolphin Wireless Manager Window

Tap **Start > Settings > Connections > Dolphin Wireless Manager** .

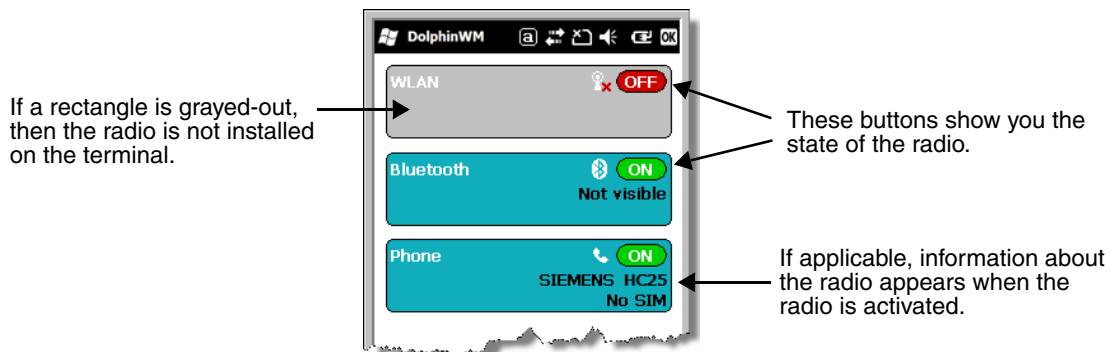

Enabling the Radios

1. Tap **Start > Settings > Connections tab > Dolphin Wireless Manager**.

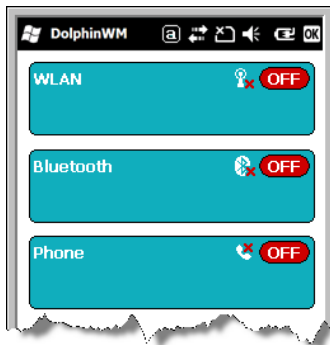

2. Tap anywhere inside the rectangle or the **OFF** button inside the rectangle.
3. The radio begins activating.

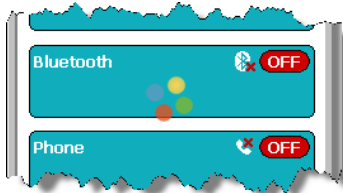

4. When the radio is activated (i.e., transmitting a signal), the **OFF** button changes to **ON**.



Note: If applicable, information about the radio appears in the rectangle.

Accessing Radio Configuration Utilities

Each of the three radios has its own configuration utilities that you can access through the **Menu**.



There are three radio configuration utilities:

For **802.11a/b/g**: Tap **WLAN Settings** and the Honeywell WLAN Security Supplicant opens. The *Honeywell WLAN Security Supplicant User's Guide* is available for download from the Dolphin 9700 product page at www.honeywellaidc.com.

For **Bluetooth**: Tap **Bluetooth Settings** and the Bluetooth Settings open. For details, see [Working with the Bluetooth Radio](#) on page 10-1.

For **GSM**: Tap **Phone Settings** and the Phone opens. For details, see [Working with GSM/HSDPA/UMTS/GPRS/EDGE](#) on page 9-1.

ActiveSync Communication

To synchronize data between the terminal and the workstation, ActiveSync 4.5 or higher must be installed and configured for the appropriate communication type on the host workstation and the Dolphin terminal. Dolphin terminals ship with ActiveSync already installed. Therefore, if ActiveSync is already installed on the host workstation, you just need to connect the Dolphin terminal to the host workstation (via Dolphin peripheral) to initiate communication.

If ActiveSync 4.5 or higher is not installed on the host workstation, you can download and install the most current version of ActiveSync from www.microsoft.com.



When communicating via ActiveSync, your terminal is designed to be connected to the host workstation with a communication peripheral sold/manufactured by Honeywell, such as the charge/communication cable. Use of any peripheral not sold/manufactured by Honeywell may cause damage not covered by the warranty.

Capabilities

- Back up and restore your device data.
- Copy (rather than synchronize) files between your device and workstation.
- Control when synchronization occurs by selecting a synchronization mode. For example, you can synchronize continually while connected to your workstation or only when you choose the synchronize command.
- Select which information types are synchronized, controlling how much data is synchronized. For example, you can choose how many weeks of past appointments you want synchronized.

Communication Types

The Dolphin terminal supports the following types of communication via ActiveSync through its [I/O Connector](#) (see page 3-10) on the bottom panel:

- USB** The USB cable and hardware peripherals allow the terminal to communicate with a workstation or to networked through a USB hub. The Dolphin terminal supports full-speed USB communication (USB 1.1); maximum data transfer rate is 12 Mbps. The Dolphin terminal defaults to USB communication out of the box.
- RS232** The RS232 cable allows the terminal to communicate with a workstation, modem, or any RS232 device. Maximum data transfer rate is 115 Kbps.

Hardware Requirements for Setup

- Dolphin communication peripheral or cable
- Dolphin power cable from Honeywell
- USB cable (for USB communication)
- Serial cable (for RS232 communication)

Software Requirements for Communication

- To synchronize successfully, ActiveSync v4.5 or higher must be configured for same communication type on both the host workstation and the Dolphin terminal. ActiveSync must be setup on your workstation *before* you initiate synchronization from the terminal for the first time.
- Windows 98 Second Edition, Windows Me, Windows 2000, Windows NT (4.0 SP6 or higher), or Windows XP operating systems.

Setting Up the Host Workstation

Verify that ActiveSync is configured to use the appropriate communication type by clicking **File > Connection Settings**.

For USB communication, check **Allow USB connections**.

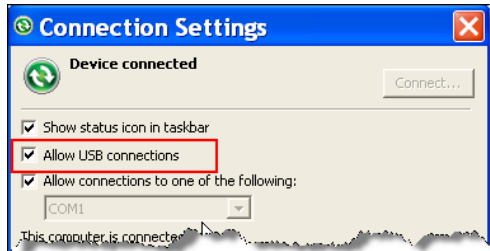

For RS232 communication, connect to **COM1**.

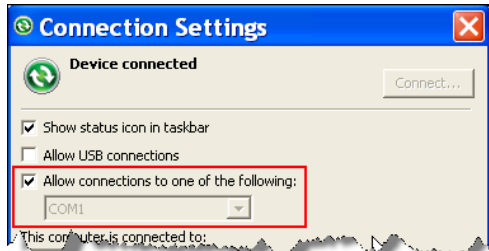

Note: You can have both USB and RS232 selected in the software without affecting processing. However, your hardware setup should use only RS232 or USB, not both.

Communicating with the Dolphin Terminal

After setting up both the workstation and the terminal, ActiveSync connection should be automatic.

1. Connect the Dolphin terminal to a Dolphin communication peripheral.
2. The Dolphin terminal automatically opens ActiveSync to establish a connection.

Synchronizing with the Host Workstation

After setup, synchronization begins automatically whenever the terminal's mechanical connector connects to a Dolphin peripheral that is connected to a host workstation with ActiveSync installed.

Exploring the Terminal from the Workstation

When the Dolphin terminal and workstation are connected, open the main ActiveSync window (on the desktop), and click **Explore**.

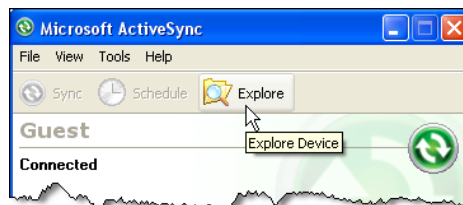

The Mobile Device folder opens in Windows Explorer.

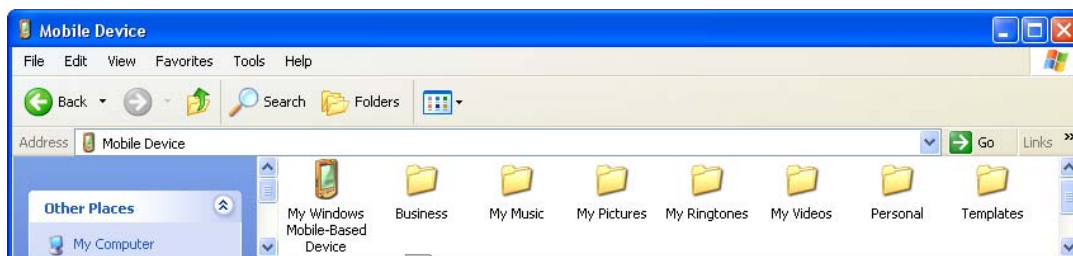

The Dolphin terminal is now treated as a mass storage device, and transferring files is as simple as dragging and dropping or copying and pasting.

Installing Additional Software

In addition to the default programs installed on your terminal when it is first booted up, you can install any program (created for a Windows Mobile-based device), as long as the terminal has enough memory to store the program and the program has an EXE, CAB, or DLL extension.

The most popular place to find software is on the Windows Mobile website: www.microsoft.com/windowsmobile/en-us/downloads/default.mspx

 *When selecting programs, verify that the program and version of the program are designed for Windows Mobile and your processor. You can verify your processor by tapping **Start > Settings > System > About > Version**. Make a note of the information in the Processor field.*

You can install additional software via:

- ActiveSync - see page 8-10.
- Infrared - see page 8-2.
- Network connection (via wireless radio) - see page 8-11.
- Connect to your ISP.

Adding Programs to the Terminal Using ActiveSync

 *When selecting programs, verify that the program and version of the program are designed for Windows Mobile and your processor. You can verify your processor by tapping **Start > Settings > System > About > Version**. Make a note of the information in the Processor field.*

Depending on the application, the software must be stored or installed on the host PC.

1. Download the program to your desktop computer from either the Internet or the CD or disk that contains the program. You may see a single EXE or setup.exe file, a CAB file, or DLL. There may also be several versions of files for different device types and processors.
2. Read any installation instructions, Read Me files, or documentation that comes with the program. Many programs provide special installation instructions.
3. Connect the terminal to the desktop computer via a Honeywell communication peripheral.

If the File is an Installer:

An installer program is one that installs on the PC and the terminal simultaneously; one process installs to both devices.

1. On the PC, double-click the EXE or *.setup.exe file. The installation wizard begins.
2. Follow the directions on the PC screen. The installation process includes transferring the software to the terminal.

If the File is Not an Installer:

Some programs cannot be installed on PCs because they are designed for terminals. In these cases, the appropriate files must be stored on the host PC, transferred via ActiveSync, and installed on the terminal. If an error message stating that the program is valid but designed for a different type of computer appears during installation, you will know the program cannot be installed on the PC.

1. If you cannot find any installation instructions for the program in the Read Me file or documentation, open **ActiveSync** and click **Explore**.
2. Click on the **My Windows Mobile-Based Device**  folder and copy the program file or files to the **Program Files** folder on the terminal.

- If you want the program to be part of the Autoinstall that occurs after every hard reset, place the program file in the **Autoinstall** folder (My Windows Mobile-Based Device > IPSM > Autoinstall).
3. Depending on the program, you may need to open **File Explorer** on the terminal, navigate to the folder where the program is located, and tap on the program file to install it.
 - If you copied the file to the **Autoinstall** folder, you can either tap on the program inside the Autoinstall folder or perform a hard reset and the program will install as part of the Autoinstall process that occurs during each hard reset. Remember, a hard reset erases RAM data! For more information, see [Hard Reset \(Cold Boot\)](#) on page 3-15.

After installation on the terminal is complete, tap **Start** and the program and its icon appears on the Start screen. Tap it to open the program.

Adding Programs Directly from the Internet



*When selecting programs, verify that the program and version of the program are designed for Windows Mobile and your processor. You can verify your processor by tapping **Start > Settings > System > About > Version** tab. Make a note of the information in the Processor field.*

1. Determine your device and processor type so that you know which version of the software to install. Tap **Start > Settings > System > About**. On the **Version** tab, make a note of the information in the **Processor** field.
2. Download the program to your device straight from the Internet using Internet Explorer Mobile. You may see a single EXE or setup.exe file, or several versions of files for different device types and processors.
3. Read any installation instructions, Read Me files, or documentation that comes with the program. Many programs provide special installation instructions.
4. Tap the file, such as an EXE file. The installation wizard begins. Follow the directions on the screen.
5. Select the radio or radio combination and tap **Apply**. The Radio Manager begins enabling your radio or radio combination.
6. When enabled, the **Status** field reads "Success".

9700 COM Port Assignment Table

COM Port	Description
COM0	Unused
COM1	Serial Port: RS232 Connector on the bottom panel
COM2	Not accessible
COM3	IrDA: Serial Infrared (SIR) up to 115 Kbps
COM4	Not accessible
COM5	Bluetooth DUN
COM6	IrCOMM

COM Port	Description
COM7	GPS: COM Port for the GPS receiver
COM8	USB Serial: Virtual USB Serial port for ActiveSync
COM9	Bluetooth BTHATCI server

Working with GSM/HSDPA/UMTS/GPRS/EDGE

Overview

The Dolphin 9700 terminal can be configured with an integrated, embedded GSM/UMTS/GPRS/EDGE penta-band radio module for WWAN communication.

GSM	Short for Global System for Mobile communications, GSM is an open, non-proprietary wireless WAN system that is constantly evolving and growing.
HSDPA	Short for High-Speed Download Packet Access, HSDPA is a non-voice value added service that allows packet-switched data to be instantly sent and received across mobile telephone networks.
UMTS	Short for Universal Mobile Telecommunications System, UMTS is a non-voice value added service that allows packet-switched data to be instantly sent and received across mobile telephone networks.
GPRS	Short for General Packet Radio Service, GPRS is a non-voice value added service that allows packet-switched data to be instantly sent and received across mobile telephone networks.
EDGE	E-GPRS is a non-voice value added service that allows packet-switched data to be instantly sent and received across mobile telephone networks at a higher data rate than standard GPRS.

Requirements

Using GSM/HSDPA/UMTS/GPRS/EDGE requires a:

- Network subscription to a GSM/HSDPA/UMTS/GPRS/EDGE network (you need to know what service providers are in your geographic area), and
- An installed SIM card that has been activated by the network service provider (see [SIM Card Installation](#) on page 9-2).

Penta Band Antenna

The GSM radio features an internal antenna that is optimized for power output and receiver sensitivity. This is an omni-directional antenna.

For the HC-25 radio, there is a unified penta-band antenna that supports 850/900/1800/1900 (GSM/GPRS/EDGE) and 850/1900/2100 (HSDPA/UMTS) MHz for obtaining GSM service worldwide.

Signal Strength

The signal strength of the GSM connection is indicated by the number of bars that appear in the signal strength icon in the Navigation bar at the top of the window.



Icon Indicates...



The signal strength of the radio connection.



The signal strength of the phone (voice) connection; see [Voice Communication](#) on page 9-4.



The signal strength of the data connection; see [Data Communication](#) on page 9-8.

Voice and Data Communication

Dolphin terminals with integrated GSM/HSDPA/UMTS/GPRS/EDGE radios are optimized for the following two-way voice and data communications:

Voice: GSM voice data (dial-up)

Data: Available speed depends on the wireless network carrier and their supported packet-data technology in addition to network conditions.

GPRS Class 10: data transmission max. 85.6 kbps (DL), max. 42.8 kbps (UL)

HSDPA: data transmission max. 3.6 Mbps (DL), max. 384 Kbps (UL)

UMTS: data transmission max. 384 Kbps (DL), max 384 Kbps (UL)

EDGE (E-GPRS) Class 10: data transmission max. 237 Kbps (DL), max. 118 kbps (UL)

You can use the GSM radio for voice communication and data communication but not at the same time. If you want to communicate over the phone (voice), you cannot send data. If you want to send data, you cannot use the phone.

SIM Card Installation

Short for Subscriber Information Module, a SIM card stores the subscriber's personal information, GSM/GPRS radio settings, security keys, contacts, etc. SIM cards can be installed in compatible mobile devices, enabling you to switch devices without losing personal and setup information.

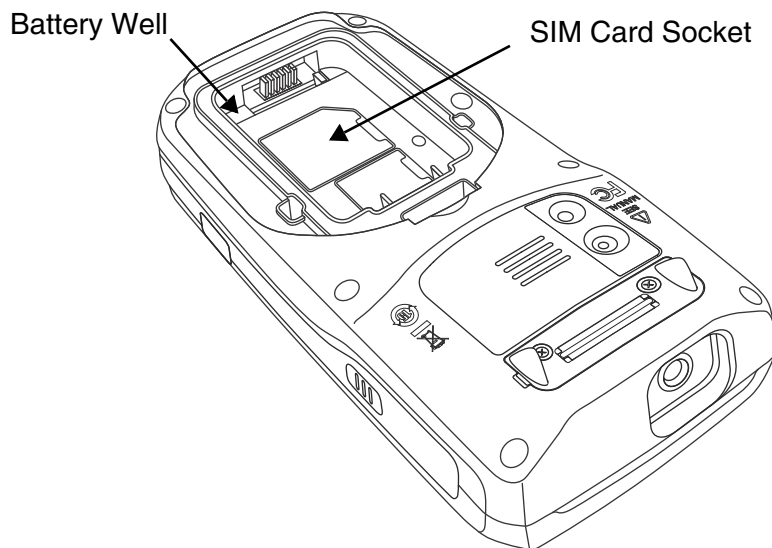

SIM Card Requirements

Before installing the SIM card:

- The service provider **must** activate the SIM card.
- The terminal **must** be powered down.

Note: If no SIM card is installed, you can still make emergency phone calls such as 9-1-1, for example.

Installing a SIM Card

1. Press the Power key  to put the terminal in Suspend Mode.
2. Release the hand strap near the base of the terminal.
3. Remove the battery door and the battery.
4. Remove the protective cover over the SIM socket.
5. Unlock the access door to the SIM socket by sliding the door away from the serial number label located in the battery well.
6. Lift the door up to expose the socket.
7. Insert the SIM card into the socket.

Note: Make sure the interface on the card is connected to the SIM Card interface in the socket; align the beveled corner of the card with the beveled corner of the socket.

8. Close and lock the access door by sliding the door toward the serial number label.
9. Replace the protective cover over the SIM socket.
10. Install the battery and the battery door.

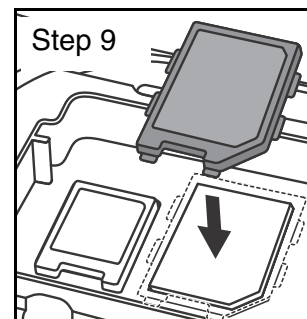
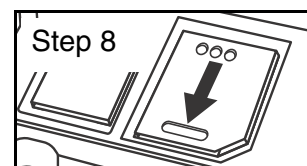
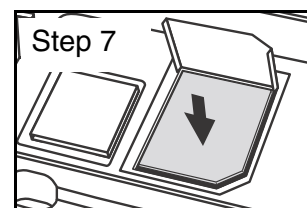
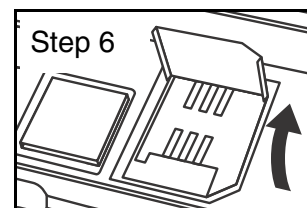
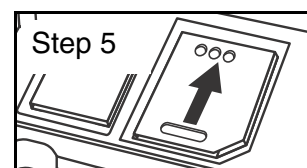
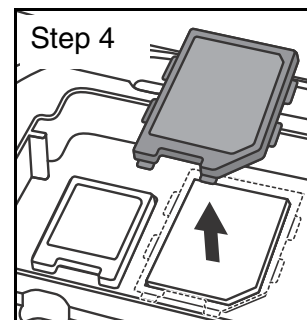

Enabling the GSM Radio

By default, the GSM radio is not enabled after a hard reset. Verify the status of the radio in the Dolphin Wireless Manager.

Tap **Start > Settings > Connections > Dolphin Wireless Manager** .

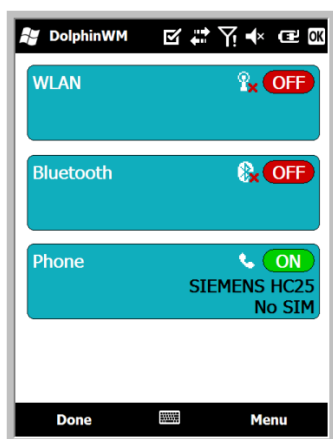

If the Phone is set to OFF, tap the Phone rectangle and the GSM radio enables.

Voice Communication

You can use the Dolphin terminal as a phone over the GSM radio.

Audio Modes

The front panel of the 9700 contains both a speaker and a microphone that you can use to send and receive audio signals over the GSM network, see [Front Panel: 9700](#) on page 3-4.

There are two audio modes:

Handset Mode: The front speaker is used for receiving handset voice calls and the front panel microphone provides audio input to the terminal.

Hands-Free Mode: Hands-free mode is when you use the rear speaker as a speakerphone. To switch to speakerphone, tap on the speaker button in the Dialer window.

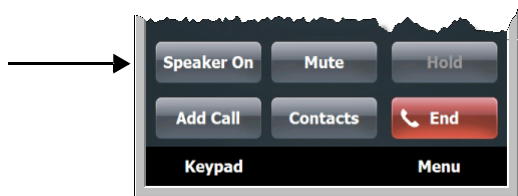

Volume Control

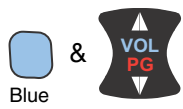

Use the Dolphin keyboard to adjust the volume.

To raise the volume, press the Blue modifier key + up arrow.

To lower the volume, press the Blue modifier key + down arrow.

Or

Press the up or down arrow on the Volume Control button on the right side of the device to adjust the volume of the active speaker, see [Volume Control Button](#) on page 3-8.

Accessing the Dialer Window

When the GSM radio is active, tap **Start > Phone** .

The Phone dialer opens.

Displays the network carrier from the SIM card. →

Displays the most recent calls. →

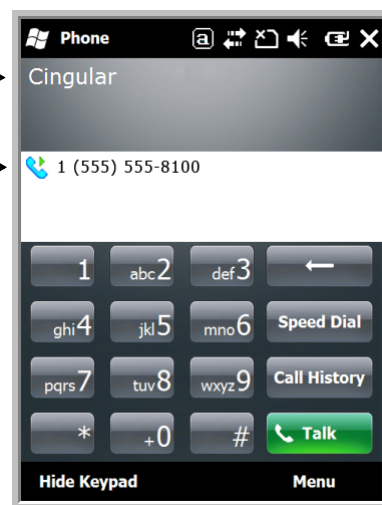

Dialing

Once the dialer window is open, you can dial out two ways:

- Tap the buttons on the dialer window.
- Use the physical keyboard (when the keyboard is in numeric mode).

Sending Calls

After the number is dialed, tap **Talk**  or press the green Send key .

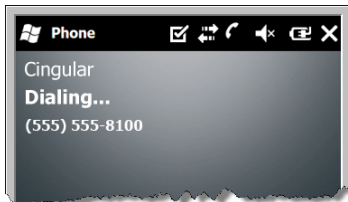





Note: The  icon indicates that the phone is in use.

Ending Calls

While the phone call is live, tap **End**  or press the red End Key .

Keyboard Combinations for Calls

Keyboard	To Send a Call, Press...	To End a Call, Press...
31-key numeric keyboard	Green Send Key 	Red End Key 
45-key QWERTY keyboard	Green Send Key 	Red End Key 

Accessing Voice Mail

Tap **Start** > **Phone**  > **Speed Dial**  > **Voice Mail** > **Call**.

Note: Update the voice mail retrieval number by turning the phone OFF and then ON via the Dolphin Wireless Manager, see [Enabling the GSM Radio](#) on page 9-4.

View Options

Tap **Menu** > **View**.

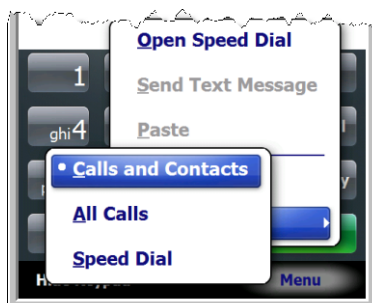

Setup Options

Tap Menu > Options.



The Phone Settings tab windows appear.

Phone Tab

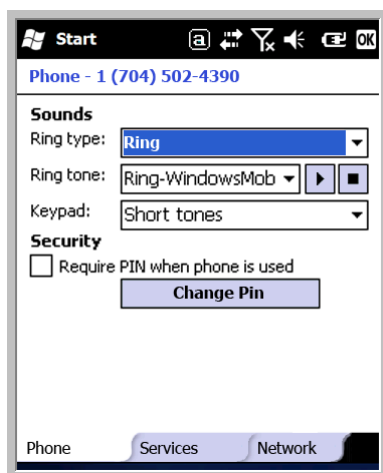

Establish or change a PIN on the Phone tab.



Services Tab

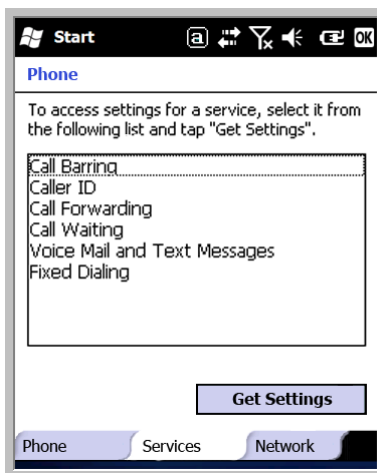

For each service, the phone will read settings from the network on the SIM card and display the available options from the carrier.

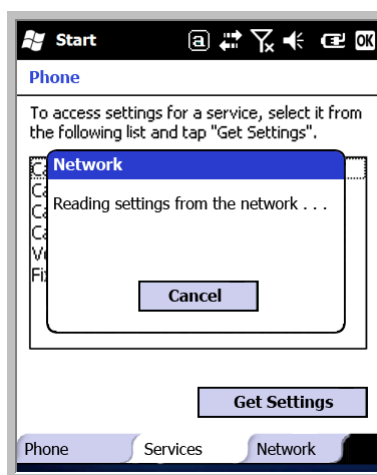

Network Tab

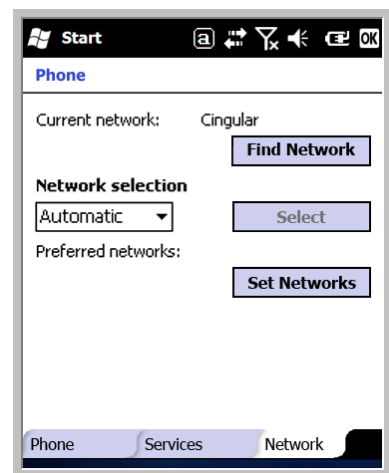

You can set networks on the Network tab.

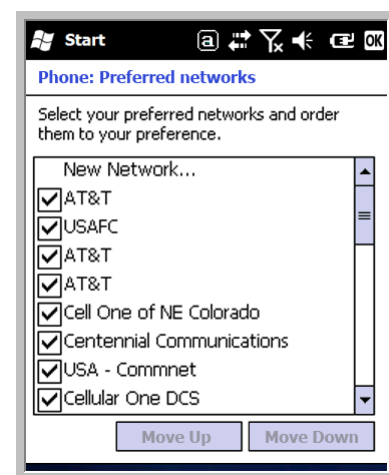

Data Communication

You set up data communication via the Connections Manager. The carrier on the SIM card is the ISP.

System Requirements

- The GSM radio must be enabled; see [Enabling the GSM Radio](#) on page 9-4.
- You must have an active SIM card with a DATA plan installed; see [SIM Card Installation](#) on page 9-2.

Information Requirements

You must have from the SIM card carrier:

- The APN (access point name).
- The username and password of the account.

Establishing Data Communication

1. Tap **Start > Settings > Connection > Connections** .
2. Under My ISP, tap **Add a new modem connection**.
3. Enter a name for the connection. Select **Cellular Line (GPRS)** as the modem. Tap **Next**.

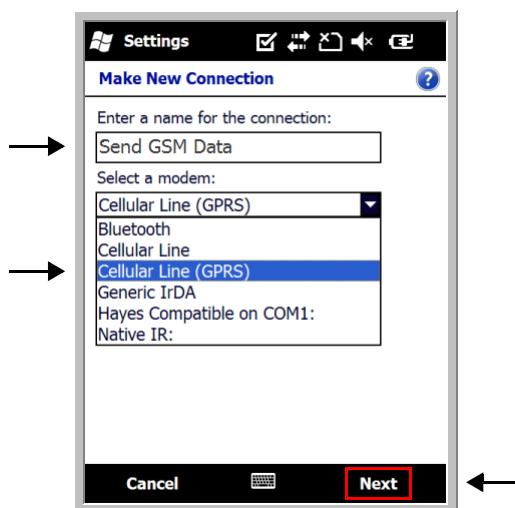

4. Enter the Access point name. Tap **Next**.

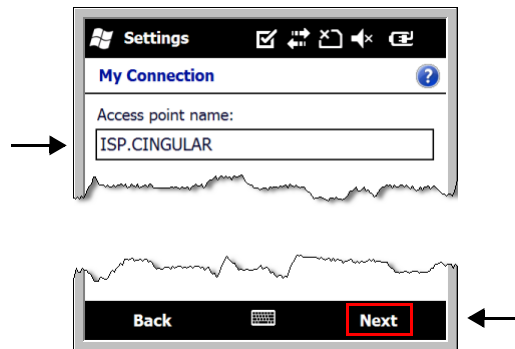

5. Enter the username and password from the account. Tap **Finish**.

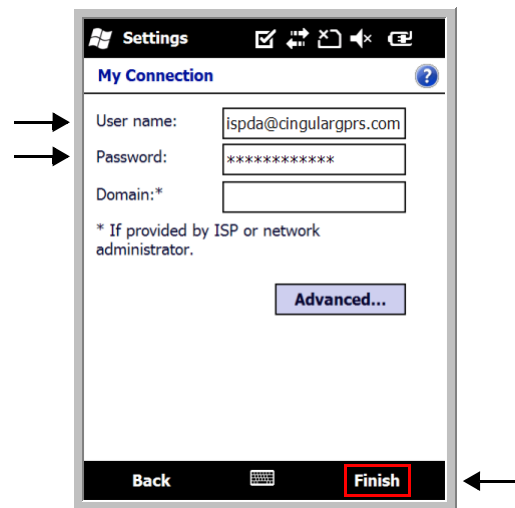

6. On the Connections window, tap **Manage existing connections**. The connection you just created should appear in the list on the modem tab.

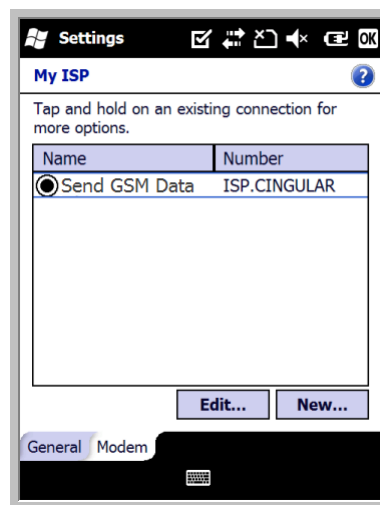

-
7. Tap and hold on the connection. Select **Connect** on the popup menu.

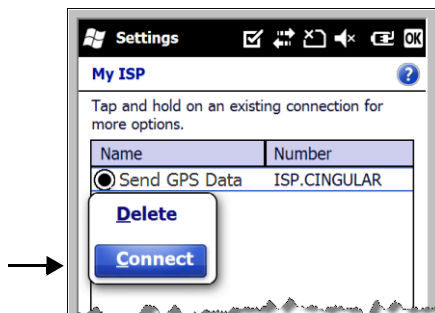

8. The network icon in the navigation bar indicates the GSM radio is attempting to connect .

Note: When the device is on a 2G (EDGE/GPRS) network, a data connection failure occurs if the phone is in use for a voice call while attempting a data connection. Simultaneous voice and data use is only supported if the device is on a 3G network. In 2G mode, a voice call takes precedence over data connections. Active data connections are placed in "park" mode automatically and the data is "retrieved" when the voice call ends.

9. When the connection is complete, the network icon changes to: .
10. You can now send data over GSM.

Ending the Data Connection

By default, the data connection will disconnect after a certain amount of time passes without use. This period of time is determined by ISP.

To end the data connection manually, tap the network icon  in the navigation bar and select **Disconnect** on the popup bubble.

Manual Network Selection

You can select Automatic or Manual network selection. The Phone defaults to Automatic network selection.

1. When an active SIM card is inserted in the terminal, tap

Start > Settings > Personal > Phone  > Menu > Options. The Phone Settings window appears.

2. Select the **Network** tab.

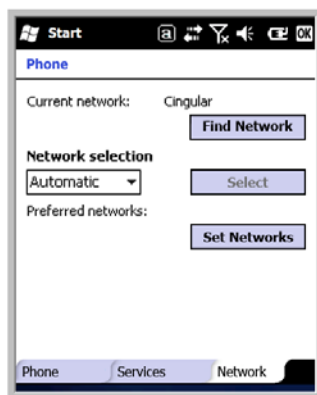

3. Under **Network selection**, select **Automatic** (the default selection) or **Manual**.

- a. If you select **Manual**, the Phone searches for available networks.



- b. The found networks appear.

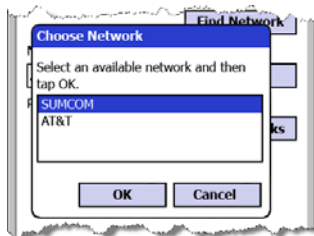

- c. Select a new network and tap **OK**. The Phone registers on the new network and the Network tab appears.



- d. To switch to another network, tap the now active **Select** button and the process repeats.

4. To switch back to automatic roaming, select **Automatic** under **Select networks** and tap **OK**.



Working with the Bluetooth Radio

Enabling the Bluetooth Radio

You enable the Bluetooth radio in the [Dolphin Wireless Manager](#) (see page 8-5).

1. Tap **Start > Settings > Connections tab > Dolphin Wireless Manager** .



2. Tap anywhere inside the Bluetooth rectangle and Bluetooth begins activating.

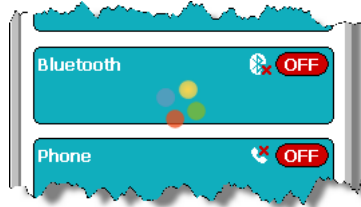

3. When the radio is activated (i.e., transmitting a signal), the **OFF** button changes to **ON**.



Now, the Bluetooth radio is transmitting a signal. Additional text in the Bluetooth section tells information about the Bluetooth radio. “Visible” and “Not visible” indicates whether the Bluetooth radio is discoverable or not discoverable by other Bluetooth devices.

Now, you can connect to other transmitting and discoverable Bluetooth devices (see page 10-2).

To make the terminal discoverable for other Bluetooth devices, you need to make the Bluetooth radio discoverable (see page 10-8).

Connecting to Other Bluetooth Devices

You need to perform a device discovery and then select a discovered device and connect to it. Pairing happens as part of the connection process.

1. In the Dolphin Wireless Manager, tap **Menu > Bluetooth Settings**.

OR

Tap **Start > Settings > Bluetooth** .

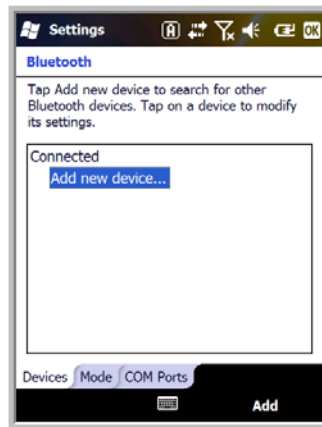

2. Tap **Add new device**. The terminal begins searching for discoverable Bluetooth devices.



3. Select a device in the list and tap **Next**.

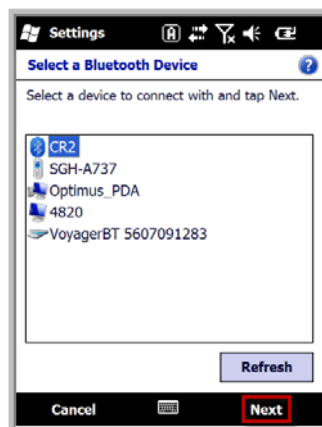

-
- You are prompted to enter a passcode.
If the device has a specific passcode, enter it in the **Passcode** field and tap **Next**.
If the device does not have a specific passcode, enter one in the **Passcode** field and tap **Next**.

The Bluetooth radio tries to connect with the device.

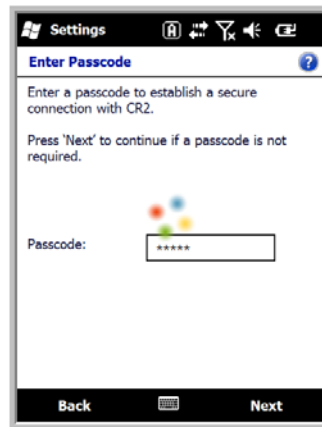

- If you created a passcode, you will be prompted by the other device to enter the same passcode. Enter the created passcode to establish a paired connection.

If you entered a device specific passcode, you should not have to do anything on the other device.
- When the connection is complete, a list of matching and supported services on the device appears.

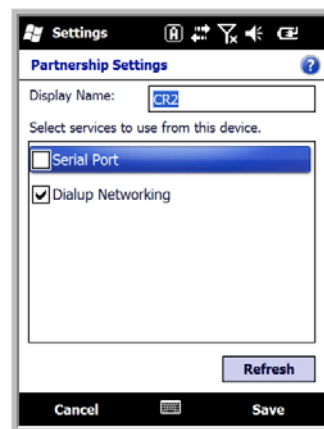

- Select the services you want to use and tap **Save**.
The services on the new devices have to be selected or the pairing won't include those services, even though the devices are paired. If services are not selected, you will be continually re-prompted for the passcode from the device.

-
8. The device appears in the list on the main window.



9. After the passcodes have been accepted on both sides, you have a trusted (“paired”) connection.

Pairing and Trusted Devices

The terminal does support pairing. Pairing happens during general connection setup. Paired devices are "trusted" devices. This means that there is unrestricted access to all services (including services that require authorization and authentication).

A connection can exclude pairing. A device that is connected to the terminal but not paired with it is considered an untrusted device. Content can still be passed to untrusted devices by requiring authorization with each attempt (for example, with the initialization of a file exchange). The Beam File method of file transfer can be used to pass a file as an untrusted device; see [Transferring Files](#) on page 10-7.

Types of Devices and Services

When you tap **Add new device** on the Devices tab, the Bluetooth radio scans for discoverable Bluetooth devices in range, which are Bluetooth devices that have been made discoverable.

Device Types

The types of devices in the vicinity of the radio appear in the list of discovered devices. →

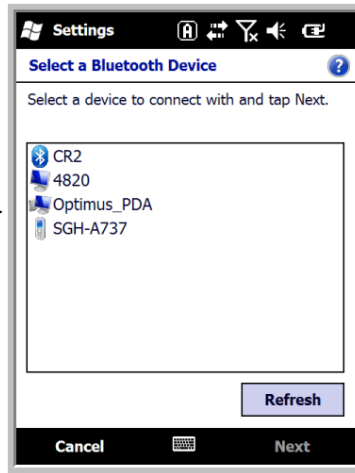

Supported Services

Only the services that are mutually supported on both devices appear on the Partnership Settings window.

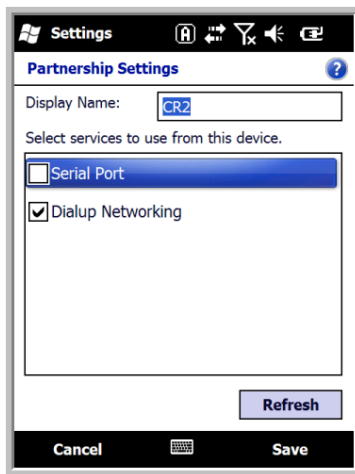

Connecting to Bluetooth Printers

1. Make sure the Bluetooth printer is in range and set to be discoverable by other Bluetooth devices.
2. Look up the Bluetooth printer's broadcasted ID.
3. Perform a device discovery (Tap **Settings** > **Bluetooth** > **Add new device**.)
4. Look for the Bluetooth printer's broadcasted ID in the list of discovered devices.
5. Click on the Bluetooth printer's ID and wait for the prompt to enter a **Passcode**.
6. Enter the **Passcode** and tap **Next**.
The passcode may default to either "1111" or "0000." If there is no default, consult the printer literature for the number.
7. Select a printing-related service in the list of services.
8. Tap **Save** to establish the connection on the terminal.
9. Complete any additional steps required by the printer.

Connecting to Bluetooth Headsets

1. Make sure the Bluetooth headset is in range and set to be discoverable by other Bluetooth devices.
2. Look up the headset's broadcasted ID.
3. Perform a device discovery (Tap **Settings** > **Bluetooth** > **Add new device**.)
4. Look for the headset's broadcasted ID in the list of discovered devices.
5. Click on the headset's ID and wait for prompt to enter a passcode.
6. Enter the **Passcode** and tap **Next**.
The passcode may default to either "1111" or "0000." If there is no default, consult the headset literature for the number.
7. Select **Headset** in the list of services.
8. Tap **Save** to establish the connection on the terminal.
9. Complete any additional steps required by the headset.

Transferring Files

1. Tap **Start > File Explorer**.
2. Navigate to the file you want to transfer.
3. Tap and hold on the file and select **Beam File** on the popup menu.

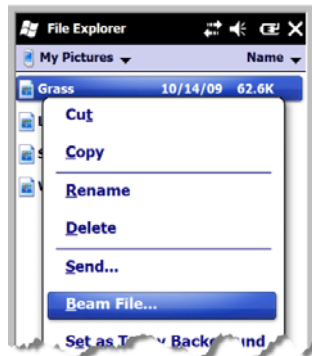

4. The Bluetooth radio begins searching for devices.

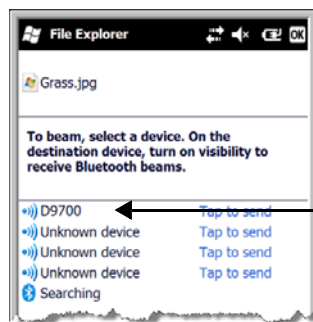

When a Bluetooth device is first found, it appears as an Unknown device; the  icon indicates that the device is a Bluetooth device.

As data is retrieved, the device IDs appear in the list.

5. Tap the device to begin sending the selected file.
6. While trying to connect, the selected device reads "Pending".

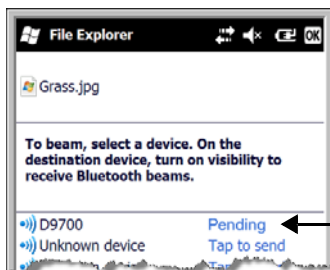

7. When the file is being transferred, the selected device reads "Sending".

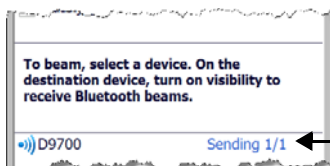

Making the Terminal Discoverable

By default, the Dolphin terminal is not discoverable, which means that the terminal will not be found by other Bluetooth devices.

To make the terminal discoverable, tap the **Mode** tab.

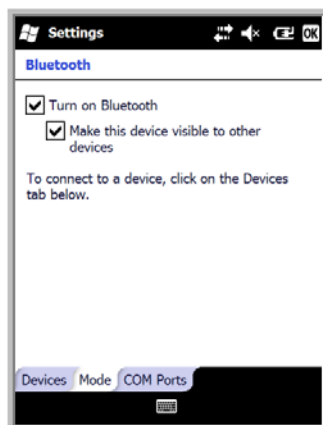

Select **Make this device visible to other devices** and tap **OK**.

Selecting COM Ports

You can select COM ports 0-9. For more information, see [9700 COM Port Assignment Table](#) on page 8-11.

Overview

The Dolphin 9700 terminal contains an integrated GPS module that allows location tracking of workers and vehicles, providing better utilization of field assets. Optional mapping and navigation software provides turn-by-turn driving directions and location information.

Assisted GPS Support

The operating system software does not inhibit nor explicitly support assisted GPS modes, which usually requires installing a vendor-specific client on the terminal that communicates with the GPS module. This client would then provide the almanac and/or ephemeris data for warm or hot start modes of operation, allowing a lower time to first fix (TTFFS). The Client must be configured on the terminal, active, and provide the data to the GPS module through the standard COM port.

Powering the GPS Module

The GPS module powers on automatically when accessed by a software application and powers off automatically when that software application closes. You cannot manually power on and off the GPS module.

Communication Ports

There are two ways to access the GPS module: through the actual COM port (COM7) or the GPS Intermediate Driver. The method you use depends on the software application you are using. If the software application requires the actual COM Port, set the operating system to use COM7. If the software application requires the GPS Intermediate Driver, set the operating system to use the GPS Intermediate Driver.

Selecting the Port

1. Tap **Start > Settings > System > External GPS**.
2. In the **GPS program port:** drop-down list, select **COM7** or **GPD1** (the GPS Intermediate Driver) as required by the application.

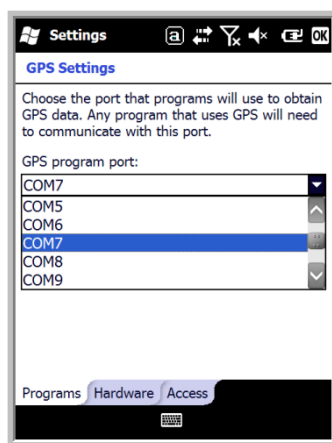

3. Tap **OK** to save.

COM7

COM Port 7 can be set to the following baud rates:

- 4800
- 9600 (This is the default baud rate and recommended for optimal GPS functioning.)
- 19200
- 38400

Other baud rates are not possible. The baud rate selected on COM7 is the actual baud rate with which the GPS will be communicating.

GPS Intermediate Driver

When the first user of GPD1 opens the port, the GPS Intermediate Driver in turn opens port COM7. The GPS Intermediate Driver allows multiple applications to open GPD1, and the GPS data is broadcast to all open ports.

When the GPSID driver is in use, the COM7 port is allocated to GPSID as READIWRITE (COM7 is still available for access mode of 0).

For more information about Microsoft's GPS Intermediate Driver, follow this link:

<http://msdn.microsoft.com/en-us/library/ms850332.aspx>

GPS Demo

The GPS Demo demonstrates the main functionality of the integrated GPS module. The GPS Demo uses COM7.

To see the GPS Demo, tap **Start > Demos > GPS Demo**.

For complete information about how to operate the GPS Demo, refer to the *Demos User's Guide* for Windows Mobile 6.5, which is available for download from www.honeywellaidc.com.

Dolphin 9700 HomeBase Device (Model 9700-HB)

Overview

As the hub of your Dolphin system, the Dolphin 9700 HomeBase charging and communication cradle supports both RS232 and USB communications, which make it able to interface with the majority of PC-based enterprise systems.

The 9700-HB charger is designed for use with battery pack models 200003231 (Li-poly 7.4V, 12.0 watt hour) and 9700-BTEC (Li-ion 7.2V, 14.4 watt hour) manufactured for Honeywell International Inc. and with Dolphin 9700 model terminals.

Charge Time

The base completes a full charge of the main battery pack installed in the terminal seated in the terminal well in 4 hours. The base completes a full charge of the main battery pack in the [Auxiliary Battery Well](#) (see page 12-2) in 4 hours.

Charging Process

The base also provides power to the intelligent battery charging system in all Dolphin terminals that senses when a full charge has been achieved and switches to a trickle charge to maintain the full charge.

Communications

Reliable data communications at speeds of up to 115k baud can be transmitted by the base through the RS232 serial port. Using the full-speed USB port, the data transmission rate goes up to 12 Mbps.

These bases cannot be physically connected to each other - sometimes referred to as "daisy-chained".

Convenient Storage

The intelligent battery charging system makes this base a safe and convenient storage receptacle for your Dolphin terminal.

Capacity

The base holds one terminal and features an auxiliary battery well behind the terminal well that can charge a battery pack independently of the terminal well. This means that one base can charge two battery packs: the one installed in the terminal and a spare.



We recommend use of Honeywell Li-Ion battery packs. Use of any non-Honeywell battery may result in damage not covered by the warranty.



We recommend use of Honeywell peripherals, power cables, and power adapters. Use of any non-Honeywell peripherals, cables, or power adapters may cause damage not covered by the warranty.

Parts and Functions

Front Panel

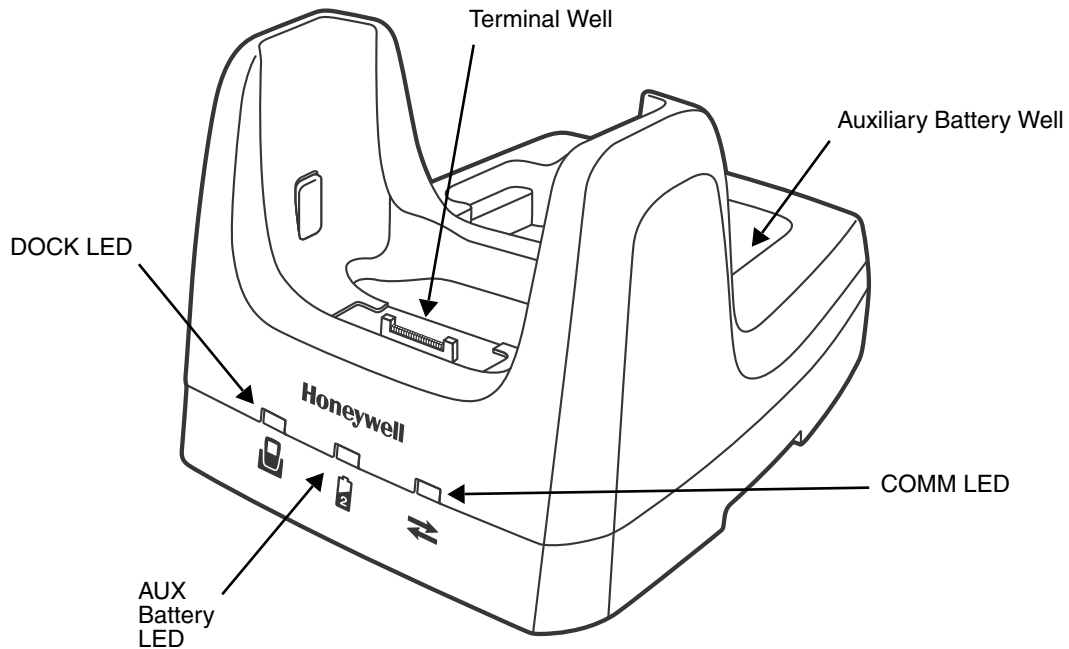

Terminal Well

Place the terminal in this well to communicate with a host device, power the terminal, and charge the installed battery pack. The base completely charges the main battery in a Dolphin terminal in 4 hours. If the host device is a workstation that uses ActiveSync, synchronization begins immediately.

Auxiliary Battery Well

See [Auxiliary Battery Well](#) on page 12-3.

DOCK LED

Turns solid green when the terminal is properly seated in the base.

AUX Battery LED

Indicates status of the battery charging in the auxiliary battery well; see [Back Panel](#) on page 12-3.

This color	means...
------------	----------

Orange	The auxiliary battery is charging.
--------	------------------------------------

Green	The auxiliary battery has completed charging and is ready for use.
-------	--

For information about charging a battery in the auxiliary battery well, see page 12-5.

COMM LED

This is the communication LED. It indicates the status of data transfer between the Dolphin terminal and the host device. The color of this LED differs if the base is using the serial or USB port connection.

If using the serial port

This color **means...**

Red Serial data is being sent from the host device to the base.

Green Serial data is being sent from the base to the host device.

Orange Serial data is being sent in both directions at the same time.

If using the USB port

This color **means...**

Green LED A USB Connection is established with the host workstation.

Back Panel

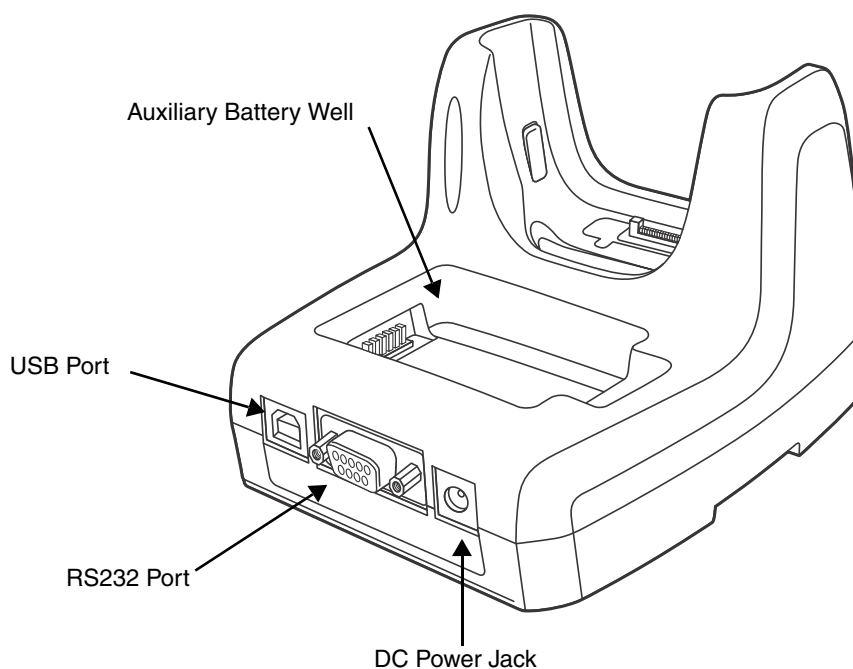

Auxiliary Battery Well

The base enables you to charge an additional Li-ion battery pack independently of the terminal well in 4 hours. This feature ensures that you can always have a fully-charged battery for your terminal. See [Charging a Spare Battery in the Auxiliary Battery Well](#) on page 12-5.

USB Port

This USB Port is full-speed and 2.0 compliant. Using a USB cable, you can connect the base to a peripheral device, such as a workstation or printer. When the terminal is seated in the terminal well, it is connected to the peripheral device via the base.

RS232 Port

Use the 9-pin, RS232 cable from Honeywell to connect this port to a peripheral device for RS232 data communication. For more information, see [Serial Connector](#) on page 12-4.

DC Power Jack

Use the power cable from Honeywell that comes with the base to supply power to this power jack. For more information, see [Power](#) section that follows.

Power

The terminal requires 9.5 Volts DC input for communications and battery charging; the power adapter on the power cable converts the voltage from the power source to 9.5 volts DC. **Use only UL listed power supply, which has been qualified by Honeywell, with output rated at 9.5V and 4.0 amps with the device.**

Honeywell recommends that you leave the base connected to its power source at all times, so that it is always ready to use.

1. Connect the power cable to the DC jack on the rear panel of the base.
2. Connect the power cable to the power adapter.
3. Plug the power adapter cable into the power source. The base is now powered.

Serial Connector

The following diagram displays the pin diagram of the serial connector of the base.

Pin	Description
1	Internal Jumper to Pin 6
2	TXD
3	RXD
4	DSR
5	GND
6	DTR
7	CTS
8	RTS
9	RI

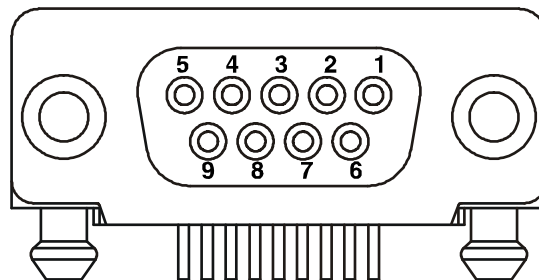

Note: Signals referenced are for a DTE device. The base is at a right-angle to the printed circuit board (PCB). The ninth pin has a ring indicator (RI).

Charging the Main Battery

The base powers the terminal and fully charges its main battery pack in 4 hours.

The base contains an intelligent battery charging system that protects the battery from being damaged by overcharging. The unit senses when a battery pack is fully charged and automatically switches to a trickle charge that maintains the battery at full capacity. Therefore, terminals may be stored in the base without damage to the terminals, battery packs, or peripherals.

To check battery power, use the Power system setting; see [Power](#) on page 7-14.

For more information about Honeywell Li-ion batteries, see [Batteries](#) on page 3-12.

To Power a Terminal and Charge its Main Battery

1. Install the battery pack in the terminal; see [Install the Main Battery Pack](#) on page 2-1.
2. Connect the base to the power supply provided by Honeywell.
3. Slide the terminal into the terminal well until the Dock LED lights green to indicate that the terminal is properly seated. The battery pack begins charging.

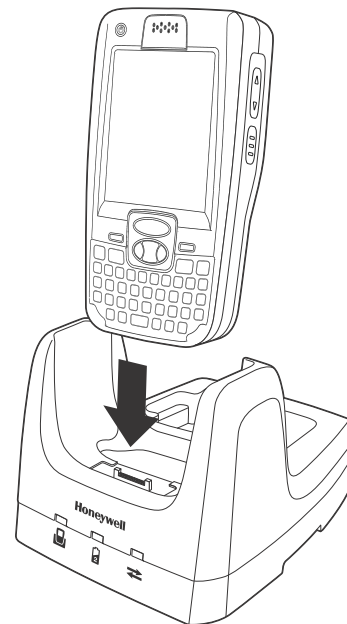

 *Ensure all components are dry prior to mating terminals/batteries with peripheral devices. Mating wet components may cause damage not covered by the warranty.*

Charging a Spare Battery in the Auxiliary Battery Well

The auxiliary battery well located on the back of the base charges a spare battery independently of the terminal well. The Aux Battery LED on the front panel indicates the status of the battery in this well.

Charge time is 4 hours; see [Auxiliary Battery Well](#) on page 12-3.

1. Insert the end of the battery without the locking tab into the bottom of the auxiliary well opening.
2. Snap the battery into place with a hinging motion. The Aux Battery LED lights orange.
3. Use the AUX Battery LED to monitor the charging progress.

Communication

USB

Dolphin terminals support USB communications out of the box.

The base also supports USB communications via the USB port located on the back. The base acts as a USB device by interfacing the USB signals of the Dolphin terminal to the USB of the host workstation. Using a standard USB cable, the base's USB interface allows the Dolphin terminal to communicate with a workstation.

RS232

The base supports RS232 communications via the RS232 Communications Port located on the back of the device. This port enables the Dolphin terminal to communicate to a workstation, modem, or any RS232 device using a standard serial cable and communications software.

Requirements

- A base powered by a power cable and power adapter cable
- For RS232 communications, a serial cable
- For USB communications, a USB cable
- ActiveSync v4.5 or above on the host workstation
- Windows[®] 98 Second Edition*, Windows[®] Me, Windows[®] 2000, Windows[®] NT (4.0 SP6 or higher), or Windows[®] XP on the host workstation.

Connecting the Communication Cables

Note: You must be using ActiveSync 4.5 or higher.

1. Plug in the power supply and connect it to the back of the base.
2. Plug the USB or the RS232 communication cable into the back of the base.
3. Connect the communication cable into the back of the workstation.
4. At this point, the hardware is installed and operating.
You may need to reboot your workstation to complete the installation process.

Establishing Communication

USB or RS232 communication with the terminal is usually auto-detected and configured by ActiveSync based on the communication cable. If you are using a USB cable to connect to the workstation, ActiveSync will usually set up a USB connection. If you are using an RS232 cable, ActiveSync will usually set up an RS232 connection.

For more details, see [ActiveSync Communication](#) on page 8-8.

Communicating with the Dolphin Terminal

To initiate communications between the Dolphin terminal and peripheral, complete these steps:

1. Insert the Dolphin terminal into the terminal well of the base.
 - The DOCK LED illuminates green. If the DOCK LED does not illuminate, make sure that the terminal is properly seated. You may need to remove and re-insert the terminal.
 - The Dolphin terminal activates; if the power is off, the terminal automatically powers on. If the terminal does not power on, verify that the Honeywell power supply is properly connected to the cradle and plugged into a functioning outlet.
 - If the base is connected to the workstation, the Dolphin terminal automatically opens ActiveSync to establish a connection.
2. The base can now transfer data between the terminal and the host device. If communication does not occur, check the port connections to ensure that the cradle is correctly configured.

Verifying Communication

You can verify that the USB driver is functioning by watching the COMM LED on the USB base. When the COMM LED illuminates solid green, the base is communicating with the host device.

Verifying Data Transfer

The COMM LED flashes when data is being transferred via the base. For an RS232 connection, the COMM LED flashes red and green. For a USB connection, the COMM LED flashes green.

RS232 Communications Cables

Connect the base to the host workstation or other device by plugging an RS232 serial cable into the RS232 Communications Port on the rear of the base. The wiring of your cable depends on whether the other device is set up as a Data Communications Equipment (DCE) or Data Terminal Equipment (DTE) device.

The Communication Port is configured as a DCE device. To communicate with a DCE device, use either a null modem adapter in line with a standard RS232 cable, or a null-modem serial cable. To communicate with a DTE device such as a workstation, use a standard (or straight-through) RS232 cable.

You can make your own cables by following the pin configuration in the chart that follows. To do so, you must determine if your host RS232 device is 9-pin or 25-pin, and whether it is configured as a DCE or DTE device.

RS232 Pin Configuration

Base /Host Port (DCE)	IBM AT DB9 (DTE)	IBM XT DB25 (DTE)	Modem DB25 (DCE)
Pin / Input Signal			
2 / (RD)	2	3	2
3 / (TD)	3	2	3
5 / (SG)	5	7	7
4 / (DTR)	4	20	6
6 / (DSR)	6	6	20
7 / (RTS)	7	4	5
8 / (CTS)	8	5	4

Note: This base cannot be daisy-chained.

Mounting

Set the base on a dry, stable surface, such as a desktop or workbench near an electrical outlet. Be sure to provide enough workspace with good lighting for the user to view and operate the Dolphin terminal while it is in the base.

When choosing a location, bear in mind that:

- the mounting location must allow users easy access to the Auxiliary Battery Well, and
- the serial and USB ports as well as the power jack face straight out of the rear panel, and you will most likely want easy access to them in the future.

Installation Hardware

Screw: 3/16 in. dia x 5/8 in. long pan head screw

Washer: 1/2 in. OD x 7/32 in. ID x 3/64 in. thick

Nut: 3/16 in. dia

Desk Mounting

The DIN rail slot (7.5 X 35 mm) may be mounted on the bottom to allow for secure desk attachment of the unit if desired.

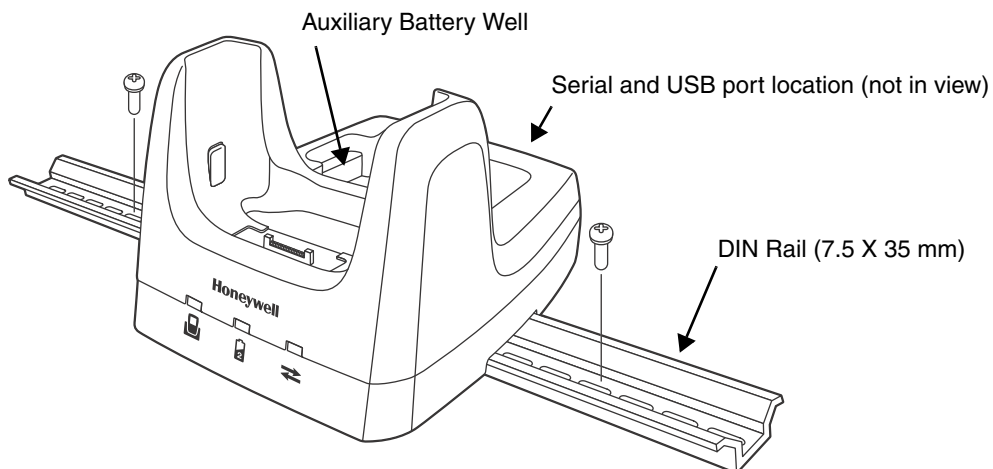

Slide the DIN rail slot along the bottom panel.

Then, using the appropriate nuts and bolts, secure the DIN rail to the desk or flat surface.



Dolphin 9700 Mobile Base Device (Model 9700-MB)

Overview

This charging and communication cradle is designed specifically for in-premise and in-transit data collection applications. It features a flexible mounting bracket, a cigarette lighter adapter, and a power cable to adapt it to your environment. The 9700-MB model is designed for use with Dolphin 9700 models using battery pack model 200003231 (Li-poly 7.4 V, 12.0 watt hour) or 9700-BTEC (Li-ion 7.2 V, 14.4 watt hour) manufactured for Honeywell International Inc.

The serial connector supports RS232 communication and power out to peripheral devices, such as handheld scanners.

As the hub of your Dolphin mobile data collection system, the base performs three important functions: charging, communications, and storage.

Charging

The base completes a full charge of the main battery pack in 4 hours. The base also provides power to the intelligent battery charging system in all terminals that senses when a full charge has been achieved and switches to a trickle charge to maintain the full charge.

Communications

The base transmits data to other devices at speeds of up to 115K baud via its RS232 serial port.

Convenient Storage

Intelligent battery charging makes the base a safe and convenient storage receptacle for your Dolphin terminal.



We recommend use of Honeywell Li-Ion battery packs. Use of any non-Honeywell battery may result in damage not covered by the warranty.



We recommend use of Honeywell peripherals, power cables, and power adapters. Use of any non-Honeywell peripherals, cables, or power adapters may cause damage not covered by the warranty.

Front Panel

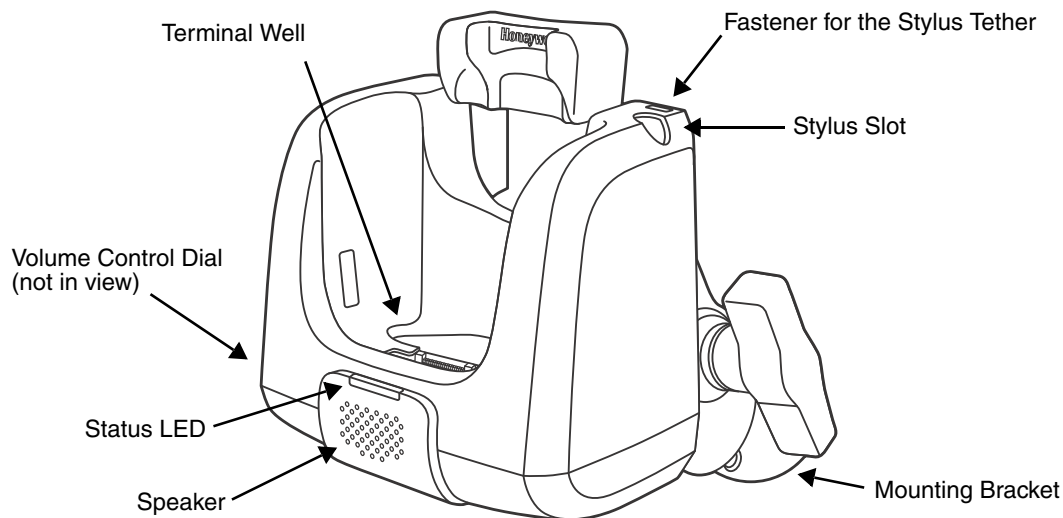

Fastener for the Stylus Tether

Stylus tethers can be purchased separately to help prevent accidental loss when the stylus is not stored in the stylus slot. A stylus tether is a coiled, elastic cord that tethers the stylus to the Mobile Base. Secure one end of the cord to the top of the base and the other end to the stylus.

Mounting Bracket

Used to mount the base to a fixed location.

Speaker

Amplifies the Dolphin's audio signals.

Status LED

Illuminates solid green when the Dolphin terminal is properly seated in the terminal well and indicates data transfer between the host device and the Dolphin terminal

Color	Indicates that...
Green	The terminal is properly docked.
Orange	The terminal is docked and communicating.

Stylus Slot

The stylus is used to operate the touch panel on the Dolphin terminal. The top panel of the mobile base features a storage slot to hold the stylus when not in use. The stylus features a special tip for added accuracy and ease of use.

Terminal Well

Place the terminal in this well. Once seated, the terminal can communicate with a host device and its main battery pack begins charging.

Volume Control Dial

The speaker volume is adjusted via the dial located on the side of the base.

Bottom Panel

The power supply and RS232 connectors are located on the bottom of the unit.

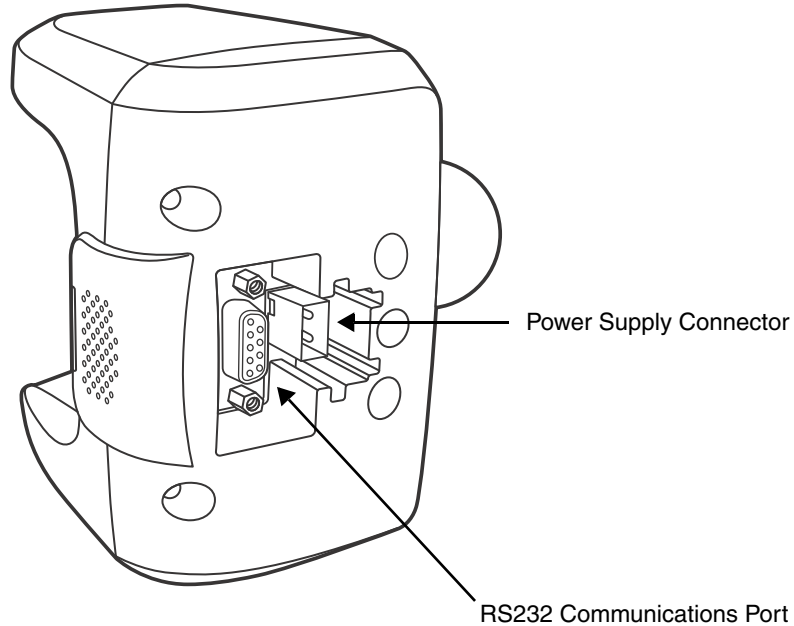

Power Supply Connector

Attach the power cable that came with the base to this connector. The base can be powered by an external DC power source of between 10 VDC to 48 VDC.

To run on vehicle power, you can use the 12 VDC cable or 24 VDC cable option. The appropriate cable comes with the kit you ordered. The 12 VDC cable can be used with a cigarette lighter outlet. The 24 VDC, pigtail cable can be used to “hard-wire” into the vehicle power bus.

 *Verify that the power source is always within the specified range and observe correct input voltage polarity. An improper input voltage range (above the 48 VDC maximum) or reverse polarity could damage the power conversion circuitry.*

RS232 Communications Port

Use a standard serial cable to connect the unit to a host device via RS232; see [Serial Connector](#) on page 13-7.

Powering the Dolphin Terminal

When seated in a base that is connected to the appropriate power source, the Dolphin terminal receives the power to charge its main battery and run its internal circuitry. Keep the base plugged into the power source so that the Dolphin terminal battery pack stays fully charged.

For more information about powering the base, see [Power](#) on page 13-6.

Charging the Dolphin Terminal

The base supplies charging power to the Dolphin terminal so that the terminal can monitor the charging of its battery pack. This charging method protects the battery from being damaged by overcharging. Therefore, the Dolphin terminal may be stored indefinitely in the base without damage to the terminal, the battery pack, or the base.

 *Ensure all components are dry prior to mating terminals/batteries with peripheral devices. Mating wet components may cause damage not covered by the warranty.*

1. Insert a battery pack into the terminal.
2. Slide the terminal, imager window up and the LCD visible, into the terminal well until it stops.
3. When the terminal is properly seated, the DOCK LED on the base illuminates solid green. The terminal begins charging automatically.

Mounting

The adjustable mounting bracket holds the terminal securely in place and gives the user a variety of options for mounting the base. When selecting a location, keep in mind that the power supply and serial connectors point straight out the bottom panel.

1. Loosen the turnscrew.
2. Insert the ball joint of the mounting bracket to the back of the bracket.
3. Insert the ball joint on the back of the base into the other side of the bracket.
4. Tighten the turnscrew to secure both ball joints.

-
5. Secure the mounting bracket to the appropriate location.

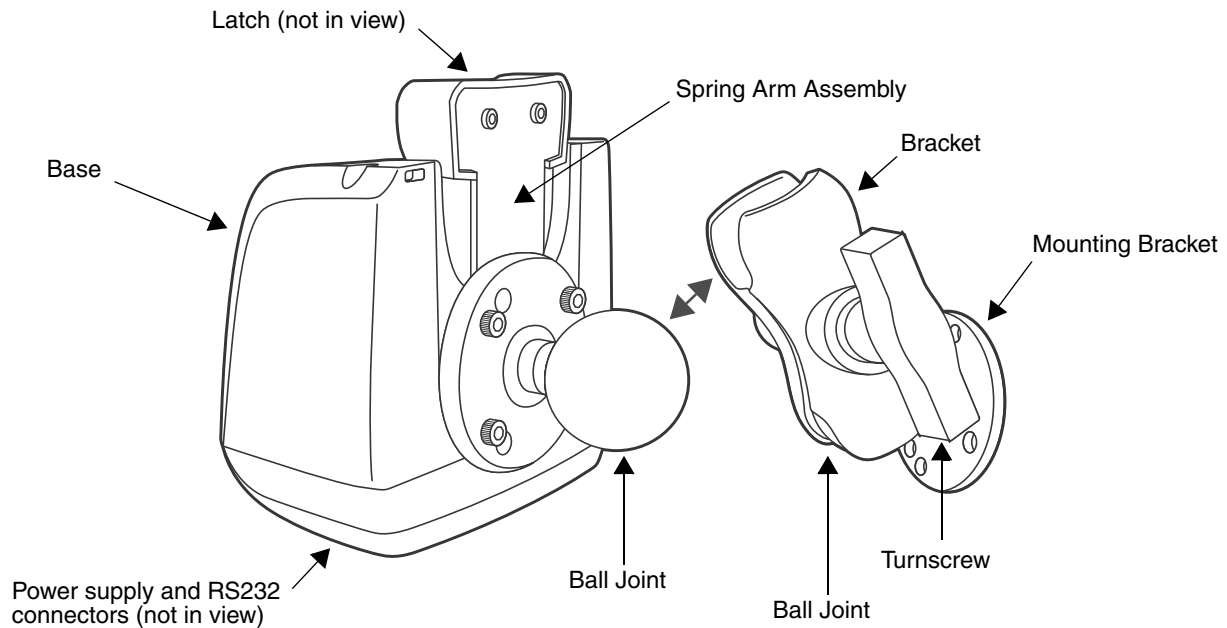

Back Panel

Latch

The latch sits on top of the spring arm assembly and holds the back of the terminal securely in place.

Spring Arm Assembly

The spring arm assembly is the column that connects the latch to the back of the base.

Ball Joints

There are two ball joints: one on the back of the base and one on the mounting bracket. Both ball joints are inserted into the bracket and secured to mount the base.

Connectors

The power and RS232 connectors are located on the bottom panel. For more information, see [Bottom Panel](#) on page 13-3.

Brackets

Bracket

The bracket contains the turn screw and two slots. Ball joints are inserted into each slot and secured with the turn screw.

Turnscrew

The turn screw is located on the top of the bracket. Rotate the turn screw to secure or loosen the ball joint slots.

Mounting Bracket

The mounting bracket is what you attach to the mounting surface. It is comprised of a ball joint and flat disk. The disk contains drill holes you use to secure the base to the mounting surface.

Power

Note: Honeywell recommends that you leave the base connected to its power source at all times.

The base is powered via the power connector on the bottom panel; see [Bottom Panel](#) on page 13-3. Both the power and serial connectors are straight out, not at an angle. The base must be powered by a 12 to 48 volt DC source.

Establishing Communication

The RS232 interface allows the terminal to communicate to a workstation, modem, or any standard RS232 device using a standard serial cable and communications software.

Requirements

You need the following equipment:

- A Mobile Base device powered by a power cable and power adapter cable
- The RS232 communications cable
- ActiveSync v4.5 or above on the host workstation
- Windows® 98 Second Edition*, Windows® Me, Windows® 2000, Windows® NT (4.0 SP6 or higher), or Windows® XP on the host workstation

Connecting the Communication Cables

Note: You must be using ActiveSync 4.5 or higher.

1. Plug in the power supply and connect it to the bottom of the base.
2. Plug the RS232 communication cable into the bottom of the base.
3. Connect the communication cable into the back of the workstation.
4. At this point, the hardware is installed and operating.
You may need to reboot your workstation to complete the installation process.

Establishing ActiveSync Communication

The Dolphin terminal is usually auto-detected and configured by ActiveSync based on the communication cable. If you are using an RS232 cable, ActiveSync will usually set up an RS232 connection.

For more details, see [ActiveSync Communication](#) on page 8-8.

Connecting the Cables

Connect the base to the host workstation or other device by plugging an RS232 serial cable into the RS232 Communications Port on the bottom of the base. Plug the other end of the RS232 serial cable into the correct port on the host RS232 device.

The wiring of your cable depends on whether the other device is set up as a Data Communications Equipment (DCE) or Data Terminal Equipment (DTE) device.

The Communication Port is configured as a DCE device. To communicate with a DTE device such as a workstation, use a standard (or straight-through) RS232 cable. To communicate with a DCE device, use either a null modem adapter in line with a standard RS232 cable, or a null-modem serial cable.

RS232 Pin Configuration

Base/Host Port (DCE)	IBM AT DB9 (DTE)	IBM XT DB25 (DTE)	Modem DB25 (DCE)
Pin / Input Signal			
2 / (RD)	2	3	2
3 / (TD)	3	2	3
5 / (SG)	5	7	7
4 / (DTR)	4	20	6
6 / (DSR)	6	6	20
7 / (RTS)	7	4	5
8 / (CTS)	8	5	4

Refer to this table if you want to make your own cables. To do so, you must determine if your host RS232 device is:

- 9-pin or 25-pin and
- configured as a DCE or DTE device.

Serial Connector

The base connector is straight to the printed circuit board (PCB). This can power a peripheral device, such as a mobile printer.

Pin	Description
1	Internal Jumper to Pin 6
2	TXD
3	RXD
4	DSR
5	GND
6	DTR
7	CTS
8	RTS
9	5 Volt Out

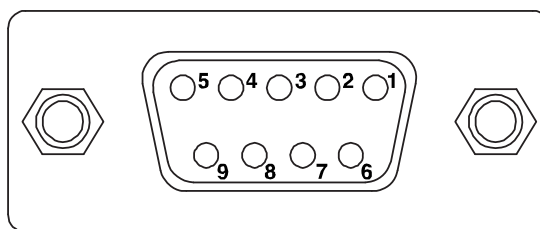

Note: Signals referenced are for a DTE device.



Dolphin 9700 ChargeBase Device (Model 9700-CB)

Overview

The ChargeBase Device (9700-CB) is a 4-slot charging cradle that can power 4 Dolphin terminals, and charge their main batteries in 4 hours. The 9700-CB model is designed for use with Dolphin 9700 models using battery pack model 200003231 (Li-poly 7.4 V, 12.0 watt hour) or 9700-BTEC (Li-ion 7.2 V, 14.4 watt hour) manufactured for Honeywell International Inc.

Charging

The base supplies power to the intelligent battery charging system in all Dolphin terminals, which senses when a full charge has been achieved and switches to a trickle charge to maintain the full charge.

As battery packs charge, the charging circuitry follows the two-step charging process (CC-CV) that is recommended for Li-ion batteries. The process monitors changes in temperature, current, and voltage.

Convenient Storage

Intelligent battery charging makes this base a safe and convenient storage receptacle for your Dolphin terminal.

Capacity

The base can hold up to 4 Dolphin terminals. Each charging slot charges each terminal independently of the other slots.



We recommend use of Honeywell Li-Ion battery packs. Use of any non-Honeywell battery may result in damage not covered by the warranty.



We recommend use of Honeywell peripherals, power cables, and power adapters. Use of any non-Honeywell peripherals, cables, or power adapters may cause damage not covered by the warranty.

Parts and Functions

Front Panel

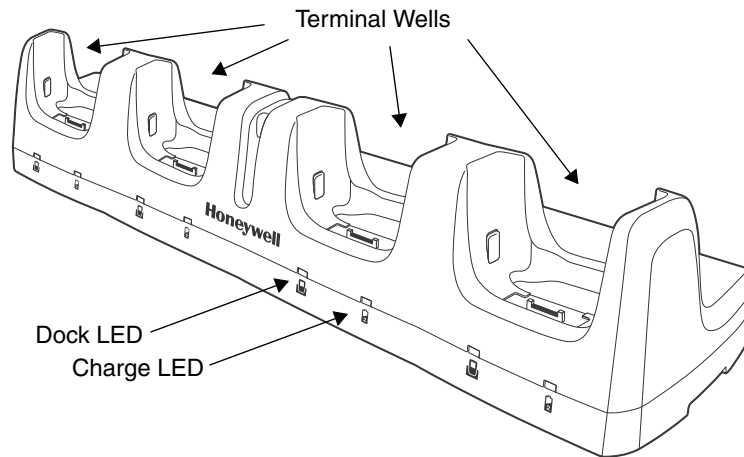

Terminal Wells

The base contains four terminal wells. Each well has its own dedicated Docking LED and Charging LED indicator.

Dock LED

Each terminal well displays a Dock LED on the front that lights solid green when a terminal is properly seated, which means that the terminal and the base are connected.

Charge LEDs

Each terminal well displays a Charge LED on the front that lights green to indicate charging. For details, see [Charging Terminals](#) on page 14-4.

Back Panel

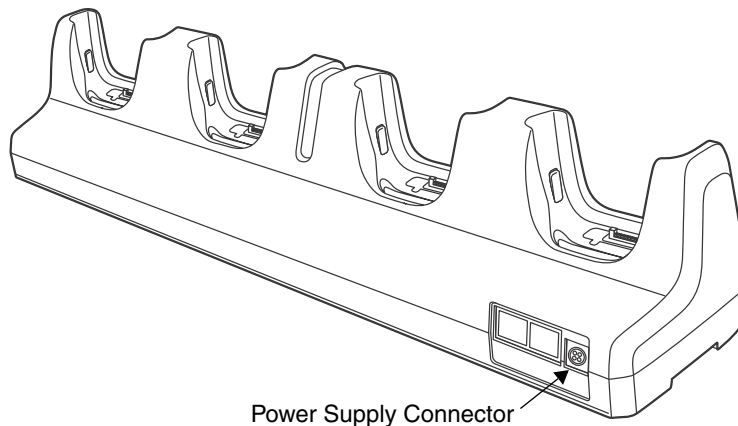

Power Supply Connector

This connector receives input from the power adapter. Plug the power connector cable from the power adapter into this connector. There is no ON/OFF switch on the back panel of the base. The power switch is on the power adapter.

Power Supply

The base includes a power supply that contains a power adapter to ensure the proper voltage. The power adapter is plugged into standard AC/DC outlets. **Use only UL listed power supply, which has been qualified by Honeywell, with output rated at 9.5V and 8.8 amps with the device..**

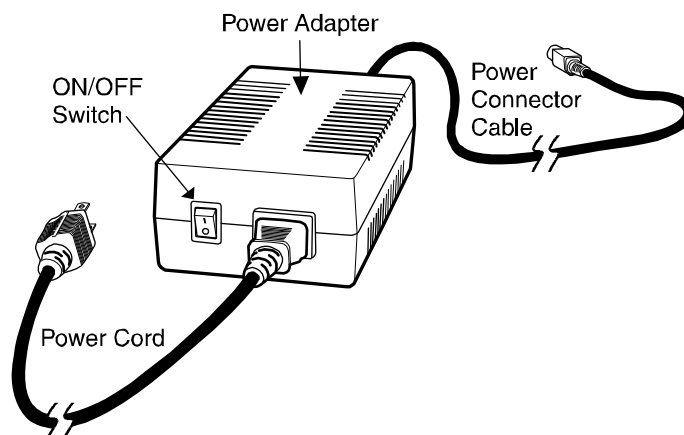

Supplying Power

1. Be sure the power switch on the power adapter is in the OFF position.
2. Plug the power cord into the power adapter.
3. Plug the power connector cable into the power connector on the back panel of the base.
4. Plug the power cord into a standard wall outlet.
5. On the power adapter, turn the power switch to the ON position. The LEDs illuminate as the base powers up.
6. The base is ready to begin charging terminals.

Inserting and Removing Terminals

 *Ensure all components are dry prior to mating terminals/batteries with peripheral devices. Mating wet components may cause damage not covered by the warranty.*

1. Slide the terminal into the well until the Dock LED lights solid green.
2. Charging begins immediately.

Note: To remove a terminal, grasp it firmly in your hand and lift it up and out of the terminal well. The LEDs turn off.

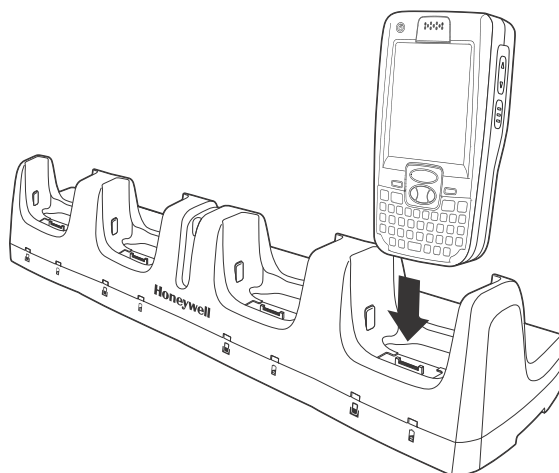

Charging Terminals

The main battery of each terminal charges in 4 hours. The intelligent battery charging system incorporated into all Dolphin terminals prevents overcharging, which means that Dolphin terminals may be seated in the base indefinitely without damage to the terminals, battery packs, or the base.

1. Power the base; see [Supplying Power](#) on page 14-3.
2. Slide the Dolphin into the terminal well. When the terminal is seated properly the Dock LED lights green. The Charge LED lights green indicating the terminal is being charged.

Mounting

This base should be mounted to a dry, stable surface. When choosing a location, always bear in mind that

- The mounting location must allow users easy access to the power connector.
- The base should be oriented so that users can easily see the LEDs.

Bottom Panel

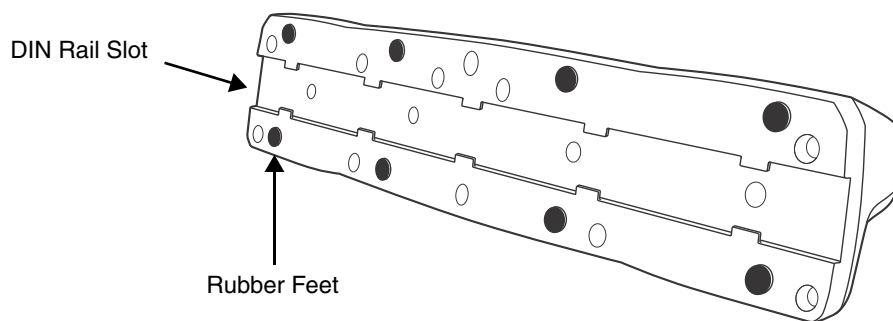

Desk Mounting

The DIN Rail (7.5 X 35 mm) slot on the bottom panel enables secure mounting.

Installation Hardware

Screw: 3/16 in. dia x 5/8 in. long pan head screw

Washer: 1/2 in. OD x 7/32 in. ID x 3/64 in. thick

Nut: 3/16 in. dia

1. Slide the DIN Rail into the DIN Rail slot on the bottom panel.

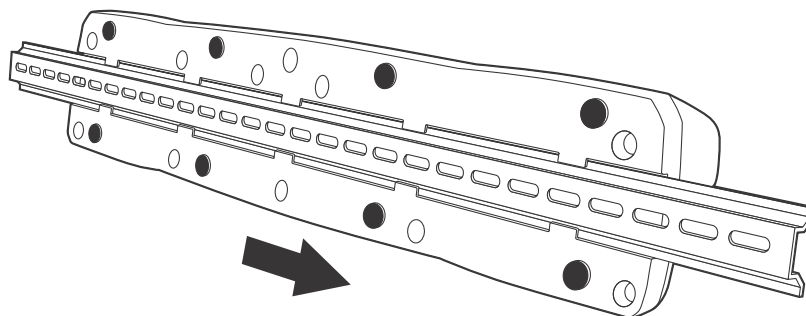

2. Turn the base and DIN Rail right side up.

-
3. Secure the DIN Rail to a stable, flat horizontal surface.

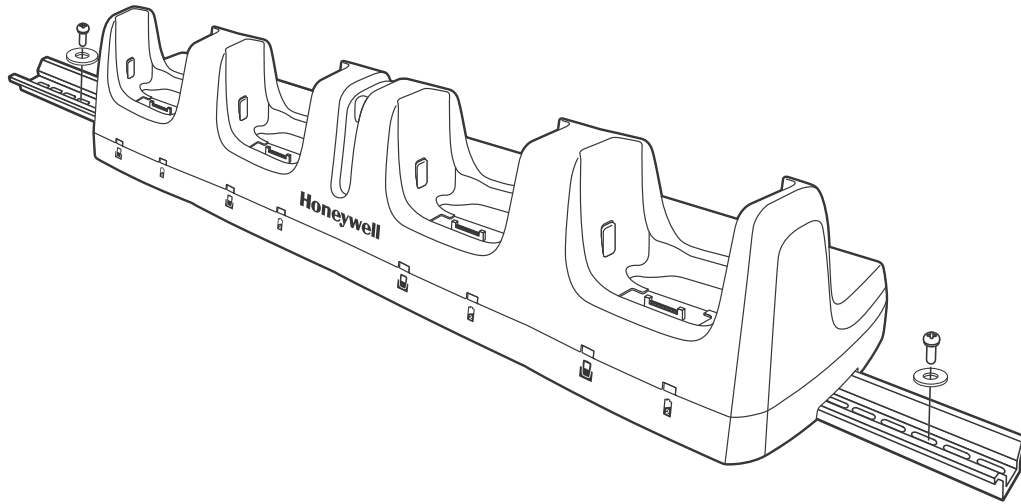



Dolphin 9700 QuadCharger Device (Model 9700-QC)

Overview

This 4-slot charging station provides intelligent battery management for the Li-ion battery packs used in Dolphin terminals. The 9700-QC charger is designed for use with battery pack models 200003231 (Li-poly 7.4 V, 12.0 watt hour) and 9700-BTEC (Li-ion 7.2 V, 14.4 watt hour) manufactured for Honeywell International Inc.

Capacity

The charger holds 4 Li-ion batteries.

Charging Time

Charge time is 6 hours.

Charging Process

Each charging slot works independently of the other three. As battery packs charge, the charging circuitry follows the two-step charging process (CC-CV) that is recommended for Li-ion batteries. The process monitors changes in temperature, current, and voltage and resets the battery pack.



We recommend use of Honeywell Li-Ion battery packs. Use of any non-Honeywell battery may result in damage not covered by the warranty.



We recommend use of Honeywell peripherals, power cables, and power adapters. Use of any non-Honeywell peripherals, cables, or power adapters may cause damage not covered by the warranty.

Parts and Functions

Top Panel

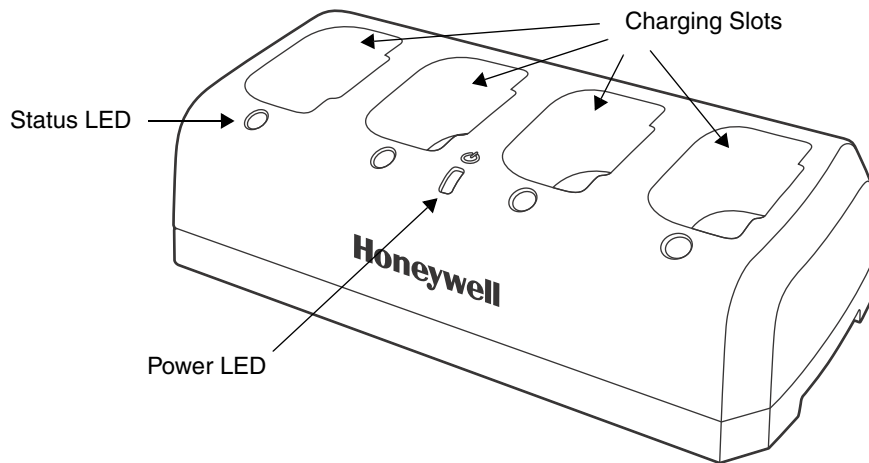

Charging Slots

There are 4 charging slots. Each slot holds one Li-ion battery and charges it independently of the other slots. When a battery is placed in each slot, it immediately begins charging.

Power LED

The power LED indicates if the QuadCharger is powered and operational. When the QuadCharger is receiving power, the LED illuminates green.

Power Supply Connector

You attach the power supply to this connector. The universal power supply accepts input voltages between 90-265 volts. See [Supplying Power](#) on page 15-3.

Status LEDs

A status LED is located above each of the 4 battery slots. The color of the LED indicates the charge status of the batteries in its slot.

Color	This color indicates that the battery in the slot...
Green (Solid)	Has completed its charge cycle and is ready for use.
Orange (Solid)	Is being charged at a maximum charge rate.
Red (Flashing)	Encountered an error during the most recent charge cycle.

Supplying Power

The charger must be connected to a power source via the Honeywell power adapter cable so that voltage is adjusted appropriately. **Use only UL listed power supply, which has been qualified by Honeywell, with output rated at 9.5V and 4.0 amps with the device.**

1. Locate the AC power adapter cable and plug it into the power source.
2. Connect the power cable to the power adapter.
3. Connect the power cable to the supply connector on the back of the charger.

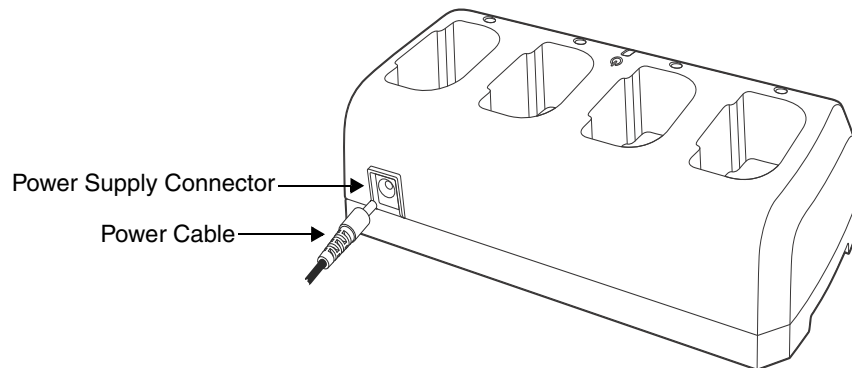

4. The power LED illuminates green, and the charger performs a self-diagnostic test that lasts approximately five seconds.

Inserting and Removing Battery Packs

To insert a battery pack, place the end of the battery opposite the locking tab into the bottom of the charging slot. The Status LED for that particular slot illuminates orange when the battery has been properly inserted.

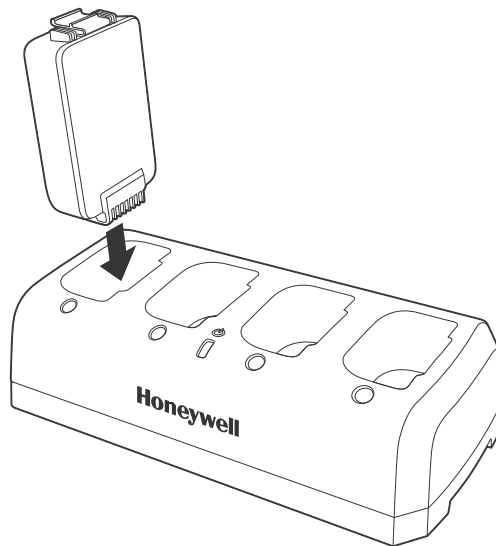

Ensure all components are dry prior to mating terminals/batteries with peripheral devices. Mating wet components may cause damage not covered by the warranty.

Recommendations for Storing Batteries

To maintain top performance from batteries, follow these storage guidelines:

- Avoid storing batteries outside of the specified temperature range of -4 to 104° F (-20 to 40°C) or in extremely high humidity.
- For prolonged storage, do not keep batteries stored in a charger that is connected to a power source.

Charging Batteries

For best results, battery packs should be at room temperature before recharging them; temperature has a marked effect on charging. The recommended temperature range is 50° to 95° F (10° to 35° C).

1. Set up the charger.
2. Power the charger
3. Insert batteries into the appropriate slots. The Status LED for each slot turns orange to indicate that the battery has begun a charge cycle.
4. When the Status LED turns green, the battery in the slot has completed charging.

Mounting

The charger should be on a dry, stable surface and can be mounted on a flat, horizontal surface such as a desktop or workbench.

When choosing a location, always bear in mind that

- the mounting location must allow users easy access to power switch and power connector.
- the charger should be oriented so that users can easily insert and remove battery packs and see the LEDs.

Installation Hardware

The DIN rail slot on the bottom panel enables secure mounting to a horizontal surface.

Screw: 3/16 in. dia x 5/8 in. long pan head screw

Washer: 1/2 in. OD x 7/32 in. ID x 3/64 in. thick

Nut: 3/16 in. dia

Desk Mounting

1. Slide the DIN rail into the DIN rail slot (7.5 X 35 mm) on the bottom of the Quad-Charger.
2. Then, using the appropriate nuts and bolts listed above, secure the DIN rail to the desktop.

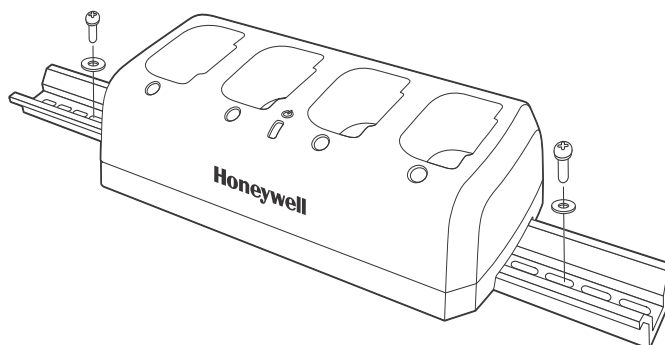

Troubleshooting

If you encounter problems with your QuadCharger device, refer to chart below for possible solutions. If problems persist, please contact Honeywell Technical Support.

Problem	Issue
The Status LED does not come on when I insert a battery pack.	Check the power connections; make sure the Power cable is inserted into the Power supply connector and the battery pack is properly seated.
The Status LED lights red during charging.	Try to charge the battery in one of the other charging slots. If the red Status LED comes on again, then the problem is associated with the battery pack. If the red status stays with the charging slot, the problem is associated with the charging circuitry.
The Status LED lights red and stays on without a battery in the charging slot.	An error occurred during the self-diagnostic test for that particular charging pocket. Call Honeywell Product Service and request an RMA. For additional warranty and return information, see Customer Support on page 16-1.



Product Service and Repair

Honeywell International Inc. provides service for all its products through service centers throughout the world. To obtain warranty or non-warranty service, contact the appropriate location below to obtain a Return Material Authorization number (RMA #) before returning the product.

North America

Telephone: (800) 782-4263
E-mail: hsmnaservice@honeywell.com

Latin America

Telephone: (803) 835-8000
Telephone: (800) 782-4263
Fax: (239) 263-9689
E-mail: laservice@honeywell.com

Brazil

Telephone: +55 (11) 5185-8222
Fax: +55 (11) 5185-8225
E-mail: brservice@honeywell.com

Mexico

Telephone: 01-800-HONEYWELL (01-800-466-3993)
Fax: +52 (55) 5531-3672
E-mail: mxservice@honeywell.com

Europe, Middle East, and Africa

Telephone: +31 (0) 40 2901 633
Fax: +31 (0) 40 2901 631
E-mail: euroservice@honeywell.com

Hong Kong

Telephone: +852-29536436
Fax: +852-2511-3557
E-mail: apservice@honeywell.com

Singapore

Telephone: +65-6842-7155
Fax: +65-6842-7166
E-mail: apservice@honeywell.com

China

Telephone: +86 800 828 2803
Fax: +86-512-6762-2560
E-mail: apservice@honeywell.com

Japan

Telephone: +81-3-6730-7344
Fax: +81-3-6730-7222
E-mail: apservice@honeywell.com

Online Product Service and Repair Assistance

You can also access product service and repair assistance online at www.honeywellaidc.com.

For ongoing and future product quality improvement initiatives, the 9700 comes equipped with an embedded device lifetime counter function. Honeywell may use lifetime counter data for future statistical reliability analysis as well as ongoing quality, repair and service purposes.

Technical Assistance

If you need assistance installing or troubleshooting your device, please call your distributor or the nearest technical support office:

North America/Canada

Telephone: (800) 782-4263
E-mail: hsmnasupport@honeywell.com

Latin America

Telephone: (803) 835-8000
Telephone: (800) 782-4263
E-mail: hsmiasupport@honeywell.com

Brazil

Telephone: +55 (11) 5185-8222
Fax: +55 (11) 5185-8225
E-mail: brsuporte@honeywell.com

Mexico

Telephone: 01-800-HONEYWELL (01-800-466-3993)
E-mail: soporte.hsm@honeywell.com

Europe, Middle East, and Africa

Telephone: +31 (0) 40 7999 393
Fax: +31 (0) 40 2425 672
E-mail: hsmeurosupport@honeywell.com

Hong Kong

Telephone: +852-29536436
Fax: +852-2511-3557
E-mail: aptechsupport@honeywell.com

Singapore

Telephone: +65-6842-7155
Fax: +65-6842-7166
E-mail: aptechsupport@honeywell.com

China

Telephone: +86 800 828 2803
Fax: +86-512-6762-2560
E-mail: aptechsupport@honeywell.com

Japan

Telephone: +81-3-6730-7344
Fax: +81-3-6730-7222
E-mail: aptechsupport@honeywell.com

Online Technical Assistance

You can also access technical assistance online at www.honeywellaidc.com.

Limited Warranty

Honeywell International Inc. ("HII") warrants its products and optional accessories to be free from defects in materials and workmanship and to conform to HII's published specifications applicable to the products purchased at the time of shipment. This warranty does not cover any HII product which is (i) improperly installed or used; (ii) damaged by accident or negligence, including failure to follow the proper maintenance, service, and cleaning schedule; or (iii) damaged as a result of (A) modification or alteration by the purchaser or other party, (B) excessive voltage or current supplied to or drawn from the interface connections, (C) static electricity or electro-static discharge, (D) operation under conditions beyond the specified operating parameters, or (E) repair or service of the product by anyone other than HII or its authorized representatives.

This warranty shall extend from the time of shipment for the duration published by HII for the product at the time of purchase ("Warranty Period"). Any defective product must be returned (at purchaser's expense) during the Warranty Period to HII factory or authorized service center for inspection. No product will be accepted by HII without a Return Materials Authorization, which may be obtained by contacting HII. In the event that the product is returned to HII or its authorized service center within the Warranty Period and HII determines to its satisfaction that the product is defective due to defects in materials or workmanship, HII, at its sole option, will either repair or replace the product without charge, except for return shipping to HII.

EXCEPT AS MAY BE OTHERWISE PROVIDED BY APPLICABLE LAW, THE FOREGOING WARRANTY IS IN LIEU OF ALL OTHER COVENANTS OR WARRANTIES, EITHER EXPRESSED OR IMPLIED, ORAL OR WRITTEN, INCLUDING, WITHOUT LIMITATION, ANY IMPLIED WARRANTIES OF MERCHANTABILITY OR FITNESS FOR A PARTICULAR PURPOSE, OR NON-INFRINGEMENT.

HII'S RESPONSIBILITY AND PURCHASER'S EXCLUSIVE REMEDY UNDER THIS WARRANTY IS LIMITED TO THE REPAIR OR REPLACEMENT OF THE DEFECTIVE PRODUCT WITH NEW OR REFURBISHED PARTS. IN NO EVENT SHALL HII BE LIABLE FOR INDIRECT, INCIDENTAL, OR CONSEQUENTIAL DAMAGES, AND, IN NO EVENT, SHALL ANY LIABILITY OF HII ARISING IN CONNECTION WITH ANY PRODUCT SOLD HEREUNDER (WHETHER SUCH LIABILITY ARISES FROM A CLAIM BASED ON CONTRACT, WARRANTY, TORT, OR OTHERWISE) EXCEED THE ACTUAL AMOUNT PAID TO HII FOR THE PRODUCT. THESE LIMITATIONS ON LIABILITY SHALL REMAIN IN FULL FORCE AND EFFECT EVEN WHEN HII MAY HAVE BEEN ADVISED OF THE POSSIBILITY OF SUCH INJURIES, LOSSES, OR DAMAGES. SOME STATES, PROVINCES, OR COUNTRIES DO NOT ALLOW THE EXCLUSION OR LIMITATIONS OF INCIDENTAL OR CONSEQUENTIAL DAMAGES, SO THE ABOVE LIMITATION OR EXCLUSION MAY NOT APPLY TO YOU.

All provisions of this Limited Warranty are separate and severable, which means that if any provision is held invalid and unenforceable, such determination shall not affect the validity of enforceability of the other provisions hereof. Use of any peripherals not provided by the manufacturer may result in damage not covered by this warranty. This includes but is not limited to: cables, power supplies, cradles, and docking stations. HII extends these warranties only to the first end-users of the products. These warranties are non-transferable.

The limited duration of the warranty for the Dolphin 9700 is as follows:

- The duration of the limited warranty for terminals with an integrated imager is one year.
- The duration of the limited warranty for touch screens is one year.
- The duration of the limited warranty for the Dolphin 9700 HomeBase device, Dolphin 9700 QuadCharger device, Dolphin 9700 Mobile Base, Dolphin 9700 ChargeBase device, and Mobile Charger is one year.
- The duration of the limited warranty for batteries is one year.
Use of any battery from a source other than Honeywell may result in damage not covered by the warranty. Batteries returned to Honeywell International Inc. in a reduced state may or not be replaced under this warranty. Battery life will be greatly increased when following the battery instructions in this user's guide.

How to Extend Your Warranty

Honeywell International Inc. offers a variety of service plans on our hardware products. These agreements offer continued coverage for your equipment after the initial warranty expires. For more information, contact your Sales Representative, Customer Account Representative, or Product Service Marketing Manager from Honeywell International Inc., or your Authorized Reseller.



Honeywell Scanning & Mobility

9680 Old Bailes Road

Fort Mill, SC 29707

www.honeywellaidc.com

Free Manuals Download Website

<http://myh66.com>

<http://usermanuals.us>

<http://www.somanuals.com>

<http://www.4manuals.cc>

<http://www.manual-lib.com>

<http://www.404manual.com>

<http://www.luxmanual.com>

<http://aubethermostatmanual.com>

Golf course search by state

<http://golfingnear.com>

Email search by domain

<http://emailbydomain.com>

Auto manuals search

<http://auto.somanuals.com>

TV manuals search

<http://tv.somanuals.com>