

# YP7999A1000 ControLinks™ Fuel Air Ratio Control Panel

## INSTALLATION INSTRUCTIONS



## FEATURES

- Pre-wired and ready to install
- Includes the R7999A control, wiring subbase and S7999D1048 touchscreen display
- Commission, monitor and control ControLinks through the touchscreen interface
- Fuel selector switch
- Alarm light
- Reset button
- Unit shutdown / Emergency stop button
- Auto/manual switch
- Manual operation potentiometer
- S7999D touchscreen display is Modbus ready

## APPLICATION

The Honeywell YP7999A1000 ControLinks Fuel Air Ratio Control Panel is a packaged, pre-wired panel that includes the R7999A ControLinks controller for linkageless fuel/air ratio control. The included S7999D color touchscreen interface allows commissioning of the ControLinks system as well as monitoring and control, all with user-friendly menus. On board selector switches, buttons and alarm lights are included for customer convenience. The ML7999A2001 universal direct coupled actuators are purchased separately.

This document provides installation instructions and operation information. Other applicable publications are:

- 65-0238, R7999 ControLinks Controller
- 65-0240, Q7999A ControLinks Universal Wiring Sub-base
- 65-0239, ML7999A Universal Parallel-Positioning Actuator
- 65-0321, S7999D1048 System Display

## SPECIFICATIONS

### Electrical Ratings

100 – 120 Vac, 50/60 Hz, 3 Amps

For individual ratings, see component literature for details.

### Environmental Ratings

Enclosure: NEMA 12.

For individual ratings, see component literature for details.

### Humidity

Install the panel where the relative humidity never reaches the saturation point. The relay module inside the panel is designed to operate in a maximum 85 percent relative humidity continuous, non-condensing, moisture environment.

### Vibration

Do not install the panel where it could be subjected to vibration in excess of 0.5G continuous maximum vibration.

### General

Overall panel size: 24 in. high x 24 in. wide x 8 in. deep (excluding door and door mounted components)

Panel weight: approx. 64 pounds

Mounting holes are 0.44 in. typical diameter, 18 in. on center.



**Approvals**

Components are individually approved by the nationally recognized agencies. Please see component literature for details. The panel has UL 508A flame control panel approval. Panel is assembled and wired to the UL Standards.

**INSTALLATION****When Installing This Product...**

1. Read these instructions and the appropriate product literature carefully. Failure to follow them could damage the product or cause a hazardous condition.
2. Refer to the installation manuals and wiring diagrams provided with this panel for the embedded products.
3. Check the ratings given in the instructions and on the product to make sure that the product is suitable for your application.
4. Installer must be a trained, experienced combustion service technician.
5. Disconnect the power supply before beginning installation to prevent electrical shock and equipment damage. More than one disconnect may be involved.
6. All wiring must comply with the National Electric Code (NEC) and any applicable local electrical codes, ordinances and regulations.
7. After installation is complete, check out product operation as provided in the appropriate product installation instructions.

**⚠ WARNING**

**Fire or Explosion Hazard. Can cause severe injury, death or property damage.**

To prevent possible hazardous burner operation, verify safety requirements each time a controller is installed on a burner.

**WIRING****⚠ WARNING**

**Electrical Shock Hazard. Can cause serious injury, death or equipment damage.**

Disconnect the power supply before beginning wiring to prevent electrical shock, equipment and control damage. More than one disconnect may be involved.

**Ground Connection**

Earth ground is required for proper operation of the ControlLinks system. The earth ground must be capable of conducting enough current to blow the fuse or breaker in the event of an internal short. Ensure the panel is bonded to a substantial earth ground. Make sure that mechanically tightened joints along the ground path are free of nonconductive coatings and protected against corrosion on mating surfaces.

**Electrical Connections**

1. Refer to the appropriate product data sheet for details.
2. Wire size and length will vary, depending on the component. Refer to the component literature for specific wire lengths, sizes and type recommendations.
3. Wire according to specifications, following all local ordinances and requirements.
4. Field knockouts are required for the wiring. When drilling holes, take care to protect the electronics from metal pieces and debris.

**IMPORTANT**

*Run line voltage and low voltage wiring in separate conduit to avoid signal interference.*

*Carefully check field wiring and terminal designations in this document and the associated wiring diagram. They are different from those of the individual components.*

**Panel Inspection**

After mounting and wiring, but before powering the panel, inspect all internal panel wire connections. Each panel is fully tested at the factory; however, wires may loosen during transit. Verify that all internal wire connections are secure from the Q7999 subbase to the components mounted on the door and the S7999D touchscreen interface.

**Final Wiring Check and Static Checkout**

All wiring shall be in accordance with the National Electric Codes (NEC) and local electrical codes.

1. Check the power supply circuit. The voltage and frequency must match the specification listed.
2. Check wiring terminations and routing to ensure proper connections.
3. Follow any system checkout recommendations for individual components as found in the component literature.
4. Restore power to the panel.

**CAUTION**

**Test each limit and interlock to ensure system operates correctly as defined in the 7800 Series "Checkout and Test" document (Form #65-0229).**

**WARNING**

**Explosion and Electrical Shock Hazard.**  
Can cause serious injury, death or equipment damage.

1. Close all manual fuel shutoff valves before starting these tests.
2. Use extreme care while testing the system. Line voltage is present on most terminal connections when power is on.
3. Replace all limits and interlocks that are not operating properly. Do not bypass limit and interlocks.

# TROUBLESHOOTING

## System Diagnostics

The S7999D touchscreen interface indicates the current fault and keeps a fault history log. The R7999 ControlLinks control and the ML7999A Universal Parallel-Positioning Actuator also have LED fault blink codes. Refer to the appropriate product instruction sheet for further troubleshooting information and diagnostic codes.

## FIELD WIRING

**Table 1. Field Wiring and Terminal Designation<sup>1</sup>.**

Terminal #	To Connecting Device	Description
1 <sup>2</sup>	L1 Panel power	120Vac Power Supply, 3A Max. L1 power to circuit breaker. Provide disconnect means and overload protection as required.
2	L2 Panel neutral	
GND	Panel ground	
4 <sup>3</sup>	L1	L1 customer convenience wire point – provided for 4 actuators – 120Vac, 50/60Hz
2 <sup>3</sup>	L2	L2 customer convenience wire point – provided for 4 actuators
GND <sup>3</sup>	Panel ground	GND customer convenience wire point – provided for 4 actuators
9	HFP	High Fire Proven output from ControlLinks controller to burner control
10	LFP	Low Fire Proven output from ControlLinks controller to burner control
11	HF	High Fire drive command input from burner controller
12	MV	Main Valve command input from burner controller
13	LF	Low Fire drive command input from burner controller
14	LCI	Limit Control Input from burner limit string, including on/off control, LWCO, high-limit, etc...
15	LCO	Limit Control Output from ControlLinks controller to burner control demand/interlock inputs
200 <sup>3,4</sup>	DR1	Air Actuator DR1 command input
201 <sup>3,4</sup>	DR2	Air Actuator DR2 command input
202 <sup>3,4</sup>	CW	Air Actuator potentiometer CW output
203 <sup>3,4</sup>	S	Air Actuator potentiometer S output
204 <sup>3,4</sup>	CCW	Air Actuator potentiometer CCW output
GND <sup>3,4</sup>	Ground	Air Actuator ground
205 <sup>3,4</sup>	DR1	Fuel 1 Actuator DR1 command input
206 <sup>3,4</sup>	DR2	Fuel 1 Actuator DR2 command input
207 <sup>3,4</sup>	CW	Fuel 1 Actuator potentiometer CW output
208 <sup>3,4</sup>	S	Fuel 1 Actuator potentiometer S output
209 <sup>3,4</sup>	CCW	Fuel 1 Actuator potentiometer CCW output
GND <sup>3,4</sup>	Ground	Fuel 1 Actuator ground
210 <sup>3,4</sup>	DR1	Fuel 2 Actuator DR1 command input
211 <sup>3,4</sup>	DR2	Fuel 2 Actuator DR2 command input
212 <sup>3,4</sup>	CW	Fuel 2 Actuator potentiometer CW output
213 <sup>3,4</sup>	S	Fuel 2 Actuator potentiometer S output
214 <sup>3,4</sup>	CCW	Fuel 2 Actuator potentiometer CCW output
GND <sup>3,4</sup>	Ground	Fuel 2 Actuator ground

**Table 1. Field Wiring and Terminal Designation<sup>1</sup>. (Continued)**

Terminal #	To Connecting Device	Description
215 <sup>3,4</sup>	DR1	FGR/4th Channel Actuator DR1 command input
216 <sup>3,4</sup>	DR2	FGR/4th Channel Actuator DR2 command input
217 <sup>3,4</sup>	CW	FGR/4th Channel Actuator potentiometer CW output
218 <sup>3,4</sup>	S	FGR/4th Channel Actuator potentiometer S output
219 <sup>3,4</sup>	CCW	FGR/4th Channel Actuator potentiometer CCW output
GND <sup>3,4</sup>	Ground	FGR/4th Channel Actuator ground
223	XmA+	Auxiliary 4-20mA+ input from Stack/Water temperature sensor (used for low fire hold)
220	XmA-	Auxiliary 4-20mA- input from Stack/Water temperature sensor (used for low fire hold)
224	CmA+	4-20mA+ input from Firing Rate control
225	CmA-	4-20mA- input from Firing Rate control
231 <sup>5</sup>	COM 2 A	S7999D COM 2 Modbus A / Data + terminal
232 <sup>5</sup>	COM 2 B	S7999D COM 2 Modbus B / Data - terminal
228 <sup>5</sup>	COM 2 GND	S7999D COM 2 Modbus C / Ground terminal

<sup>1</sup> Carefully check field wiring and terminal designations in this document and the associated wiring diagram. They are different from those of the individual components.

<sup>2</sup> The circuit protection incorporated into this control panel is designed to serve as supplemental protection only. It is the responsibility of the end user to provide appropriate protection on the service to this control panel. Refer to the National Electric Code and UL standard 1077 for more information on this subject. Use 16 AWG MTW wire.

<sup>3</sup> Low voltage wire to the firing rate actuators must be run in separate conduit. Line voltage wiring to actuators may be obtained from terminals 4, 2 and GND or provided by customer. Run line voltage wires in separate conduit. Refer to the ML7999A product sheet for details.

<sup>4</sup> Connect the shield ground of the ML7999A actuator(s) to the earth ground strip provided in the Q7999 universal subbase, on the low voltage side. Connect the shield at the controller end only. Refer to the ML7999A product sheet for details.

<sup>5</sup> COM 2 on the S7999D is wired to field terminals for customer use. Customer may wire an existing Modbus-capable RM78xxL burner control and/or Modbus-enabled UDC2500/3200/3500 controls in a daisy-chain fashion to the customer terminals for display on the S7999D. Refer to the S7999D, S7800A or S7810M and UDC control product manuals for further information on wiring and S7999D display set-up.

<sup>6</sup> Installation, operation and maintenance shall conform with National Fire Protection Association standards, national and local codes and authorities having jurisdiction.

<sup>7</sup> For detailed device wiring information, refer to the R7999, Q7999A, ML7999A and S7999D1048 product sheets.

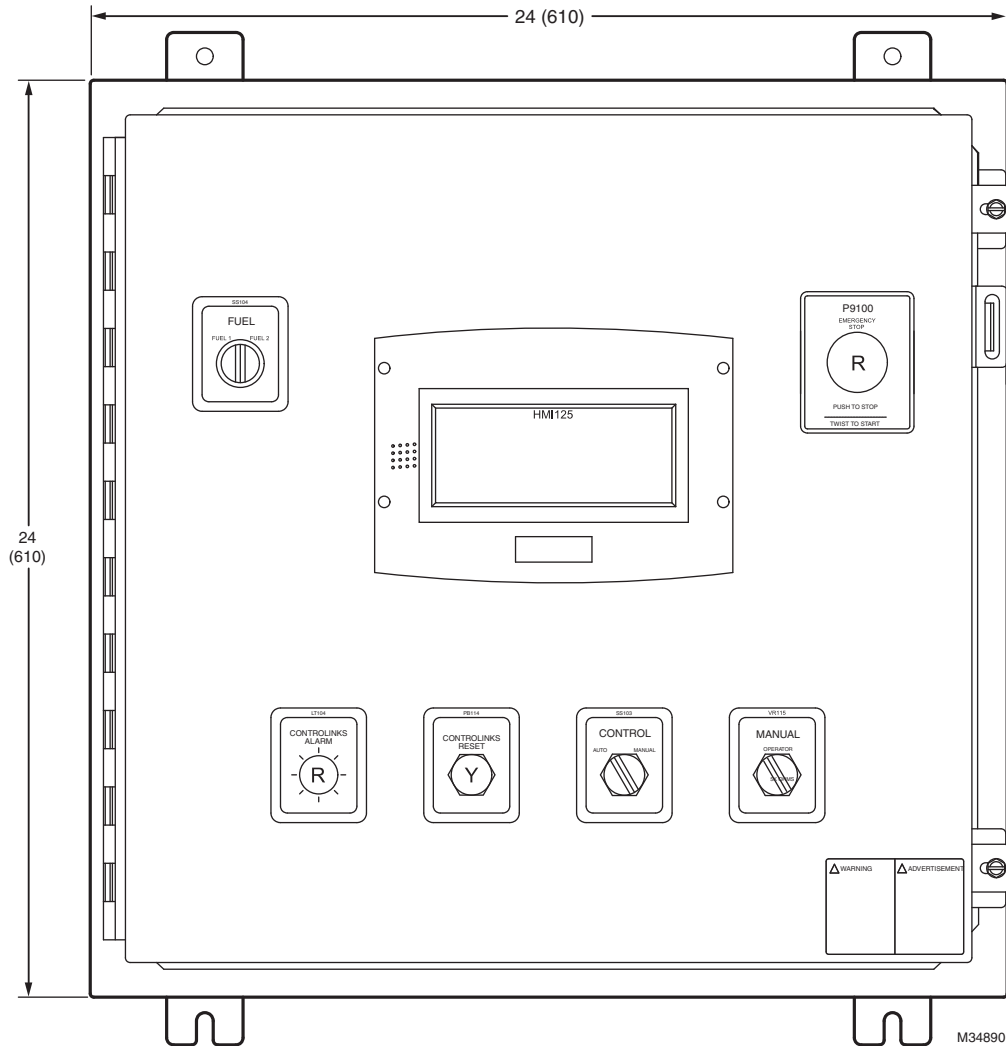

Fig. 1. Panel front dimensions in in. (mm).

Table 2. Wire Code.

Function	Color	AWG
120 VAC (HOT)	RED	16 (MTW)
120 VAC (NEUTRAL)	WHITE	16 (MTW)
GROUND	GREEN	16 (MTW)
DRY CONTACTS	YELLOW	16 (MTW)
VDC	BLUE	16 (MTW)
24 VAC	BROWN	16 (MTW)
TYPE K THERMOCOUPLE	YELLOW/RED	20 (POLYVINYL)
FSG RESET/CONTROLINKS RESET/POTENTIOMETER	BELDEN 8760	18 AWG TWISTED PAIR
ACTUATOR INTERFACE	BELDEN 9535	24 AWG, 5 CONDUCTOR
DISPLAY TO TERMINAL STRIP	BELDEN 9535	24 AWG, 5 CONDUCTOR
DISPLAY COM1 & COM2 (FROM TERM STRIP TO DEVICES)	BELDEN 8770	18 AWG, 3 CONDUCTOR
TEMP CTRL MODBUS	BELDEN 8770	18 AWG, 3 CONDUCTOR

YP7999A1000 CONTROLINKS™ FUEL AIR RATIO CONTROL PANEL

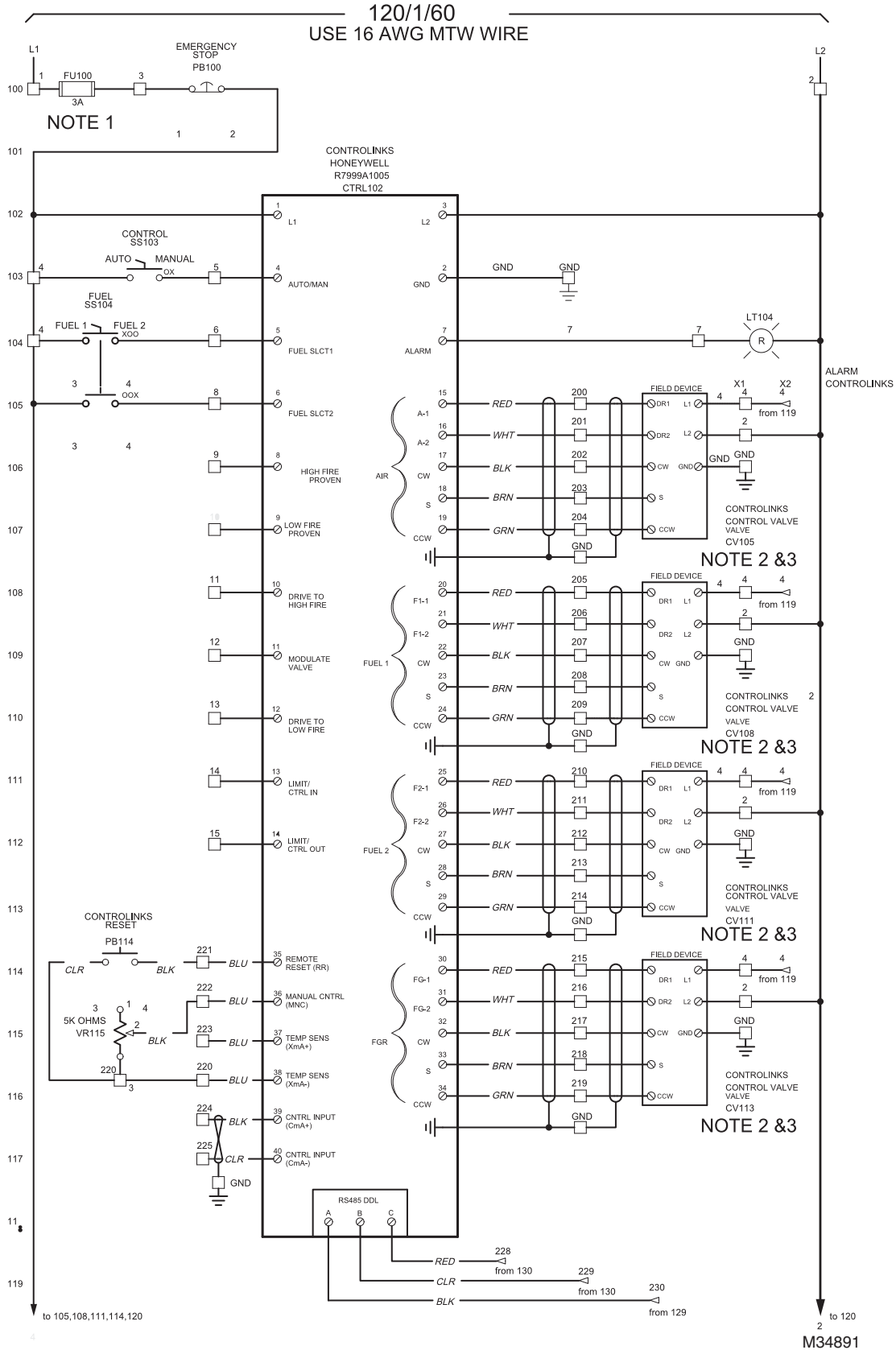
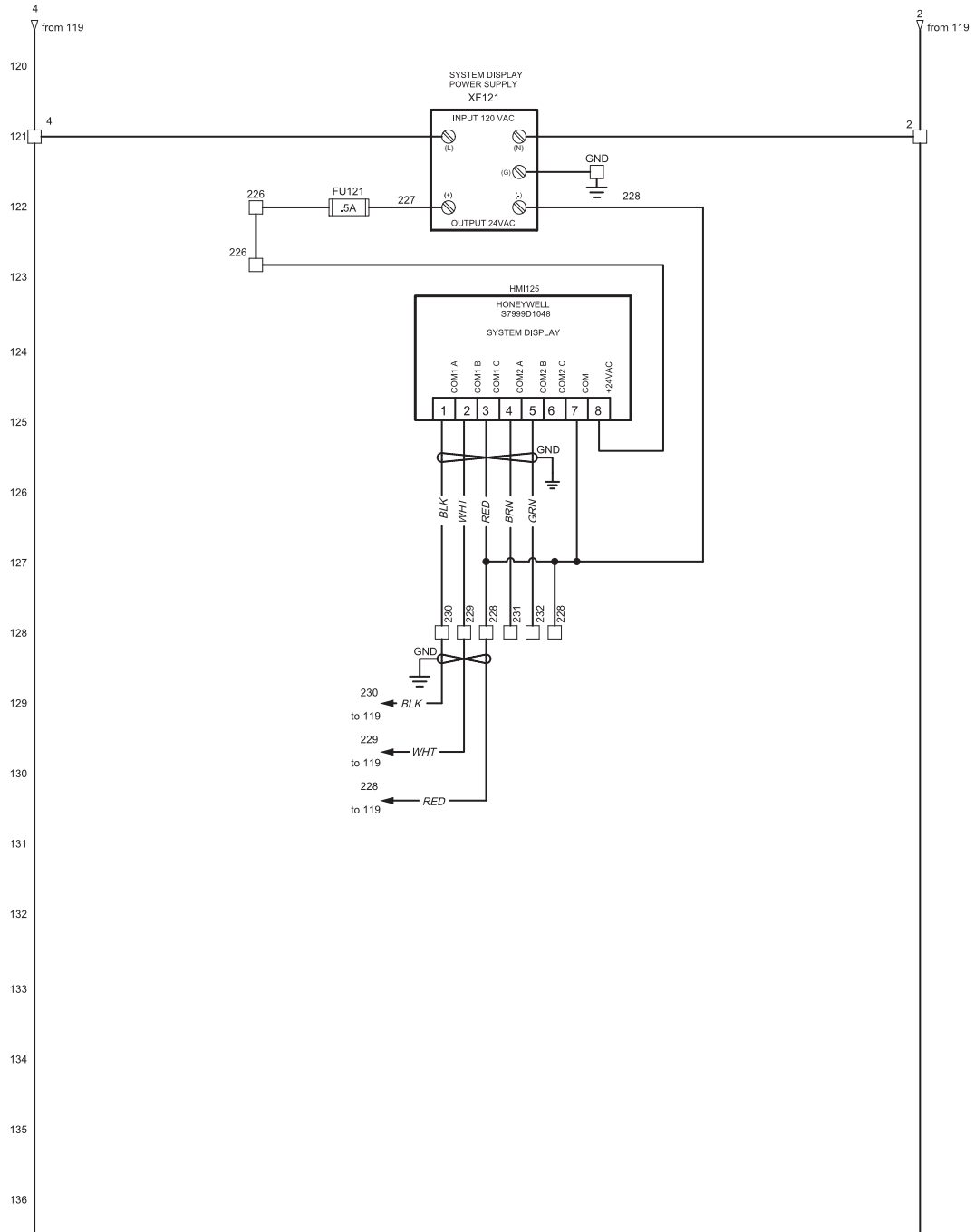





Fig. 2. Wiring diagram (part 1).



M34892

Fig. 3. Wiring diagram (part 2).

### Wiring Diagram Key

-  Indicates terminals and wiring in control panel (main terminal block).
-  Indicates external wiring.
-  Indicates terminals in valves.
-  Indicates component terminals.

### Wiring Notes

1. The circuit protection incorporated into this control panel is designed to serve as supplemental protection only. It is the responsibility of the end user to provide appropriate protection on the service to this control panel. Refer to the National Electric Code and UL Standard 1077 for more information.
2. Wire to the firing rate actuator must be run in separate conduit.

3. Ground shield to subbase earth ground screw on low voltage side of subbase.
4. Installation, operation, and maintenance shall conform with National Fire Protection Association standards, national and local codes, and authorities having jurisdiction.

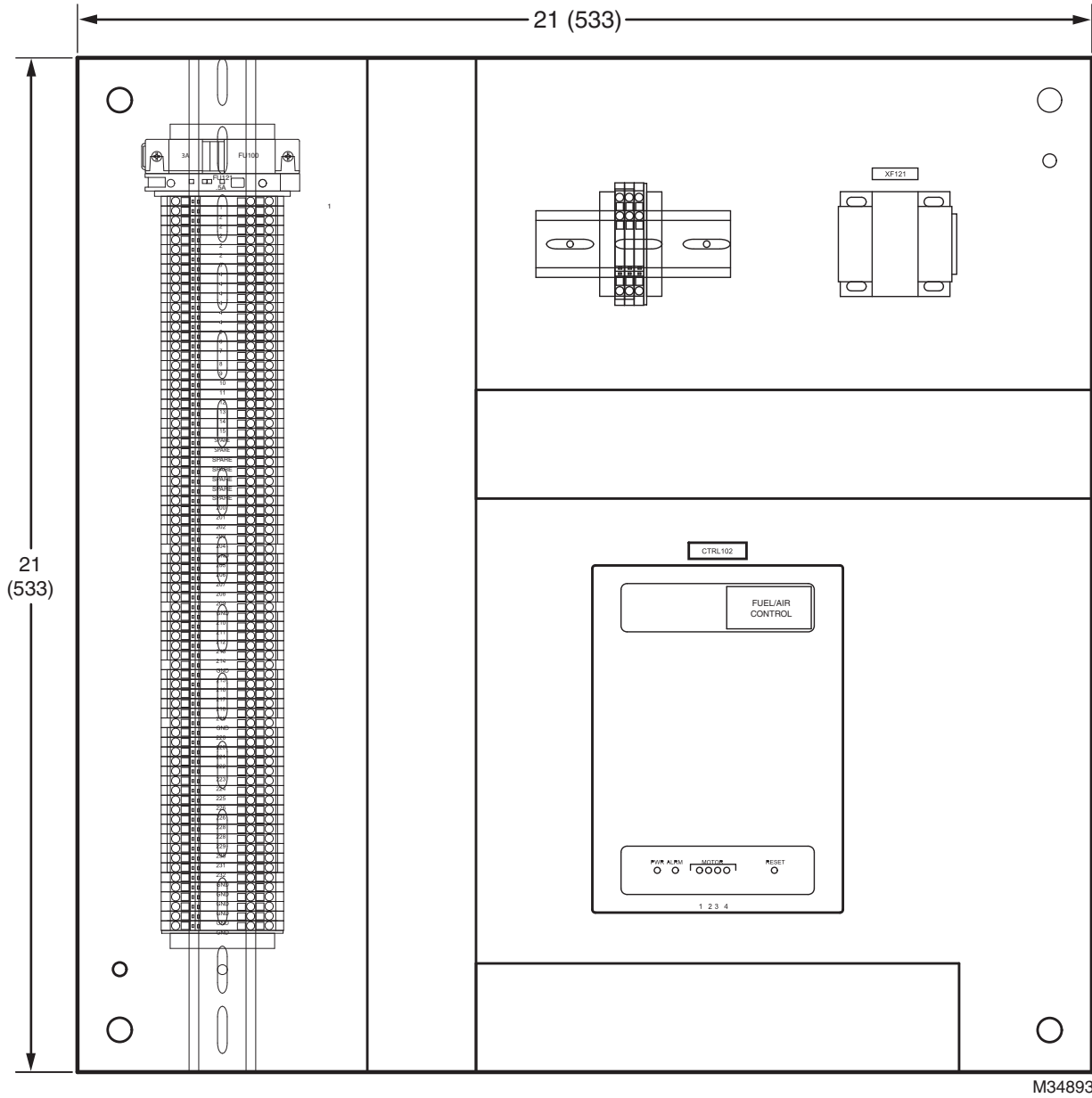

M34893

Fig. 4. Equipment mounting panel dimensions in in. (mm).

**Automation and Control Solutions**

Honeywell International Inc.  
 1985 Douglas Drive North  
 Golden Valley, MN 55422  
 customer.honeywell.com



© U.S. Registered Trademark  
 © 2013 Honeywell International Inc.  
 66-2060—01 M.S. 06-13  
 Printed in United States



## Free Manuals Download Website

<http://myh66.com>

<http://usermanuals.us>

<http://www.somanuals.com>

<http://www.4manuals.cc>

<http://www.manual-lib.com>

<http://www.404manual.com>

<http://www.luxmanual.com>

<http://aubethermostatmanual.com>

Golf course search by state

<http://golfingnear.com>

Email search by domain

<http://emailbydomain.com>

Auto manuals search

<http://auto.somanuals.com>

TV manuals search

<http://tv.somanuals.com>