

# MX3Plus

---

Hand-Held Computer

Microsoft® Windows® CE 5 Operating System

## User's Guide

---

# Disclaimer

Honeywell International Inc. ("HII") reserves the right to make changes in specifications and other information contained in this document without prior notice, and the reader should in all cases consult HII to determine whether any such changes have been made. The information in this publication does not represent a commitment on the part of HII.

HII shall not be liable for technical or editorial errors or omissions contained herein; nor for incidental or consequential damages resulting from the furnishing, performance, or use of this material.

This document contains proprietary information that is protected by copyright. All rights are reserved. No part of this document may be photocopied, reproduced, or translated into another language without the prior written consent of HII.

© 2008-2012 Honeywell International Inc. All rights reserved.

Web Address: [www.honeywellaidc.com](http://www.honeywellaidc.com)

RFTerm is a trademark or registered trademark of EMS Technologies, Inc. in the United States and/or other countries.

Microsoft® Windows, ActiveSync®, MSN, Outlook®, Windows Mobile®, the Windows logo, and Windows Media are registered trademarks or trademarks of Microsoft Corporation.

Intel® and Intel XScale® are trademarks or registered trademarks of Intel Corporation or its subsidiaries in the United States and other countries.

Summit Data Communications, the Laird Technologies Logo, the Summit logo, and "Connected. No Matter What" are trademarks of Laird Technologies, Inc.

The Bluetooth® word mark and logos are owned by the Bluetooth SIG, Inc.

Symbol® is a registered trademark of Symbol Technologies. MOTOROLA, MOTO, MOTOROLA SOLUTIONS and the Stylized M Logo are trademarks or registered trademarks of Motorola Trademark Holdings, LLC and are used under license.

Wavelink®, the Wavelink logo and tagline, Wavelink Studio™, Avalanche Management Console™, Mobile Manager™, and Mobile Manager Enterprise™ are trademarks of Wavelink Corporation, Kirkland.

RAM® and RAM Mount™ are both trademarks of National Products Inc., 1205 S. Orr Street, Seattle, WA 98108.

Acrobat® Reader © 2012 with express permission from Adobe Systems Incorporated.

Other product names or marks mentioned in this document may be trademarks or registered trademarks of other companies and are the property of their respective owners.

## Patents

For patent information, please refer to [www.honeywellaidc.com/patents](http://www.honeywellaidc.com/patents).

## Limited Warranty

Refer to [www.honeywellaidc.com/warranty\\_information](http://www.honeywellaidc.com/warranty_information) for your product's warranty information.

# Table of Contents

<b>Chapter 1: Introduction</b>	<b>1-1</b>
About This Guide	1-1
End User License Agreement (EULA)	1-1
Laser Warnings and Labels	1-2
Label Location	1-2
Label	1-2
Components	1-3
Front	1-3
Back	1-4
Endcap	1-4
Endcap Options	1-5
<b>Chapter 2: Set Up A New MX3Plus</b>	<b>2-1</b>
Hardware Setup	2-1
Software Setup	2-1
End User License Agreement (EULA)	2-1
Battery	2-2
Connect or Remove the Battery Pack	2-2
Insert/Replace Battery	2-2
Remove Battery	2-3
Hotswap the Main Battery	2-3
Charge or Recharge the Main Battery	2-4
Backlights and Indicators	2-5
Tapping the Touch Screen with a Stylus	2-6
Touch Screen	2-7
Calibrating the Touch Screen	2-7
Adjusting the Display Backlight Timer	2-7
Apply the Touch Screen Protective Film	2-7
Using the Input Panel / Virtual Keyboard	2-8
Set Date and Time Zone	2-9
Grab Time Utility	2-9
Autolaunch Time-Sync	2-9
Synchronize with a Local Time Server	2-9
Set Power Scheme Timers	2-10
Battery Power Scheme	2-10
AC Power Scheme	2-10
Adjust Speaker Volume	2-11
Using the Keypad	2-11
Using the Control Panel	2-11

Setup Terminal Emulation Parameters.....	2-12
Using the AppLock Switchpad.....	2-13
Using the Keypad.....	2-13
Using the Touch Screen.....	2-13
Connecting Bluetooth Devices.....	2-14
Taskbar Connection Indicator.....	2-14
Reboot.....	2-15
Warm Boot.....	2-15
Cold Boot.....	2-15
Attaching the Handstrap.....	2-16
Attach Stylus Tether and Sleeve.....	2-17
Adjust Headset / Microphone and Secure Cable.....	2-18
Cleaning the Touch Screen and Scanner Aperture.....	2-19
Startup Help.....	2-20
Continuous Scan Mode.....	2-20
<b>Chapter 3: Connecting Cables to the MX3Plus.....</b>	<b>3-1</b>
Connect Cable - USB Host.....	3-1
Connect Cable - USB Client.....	3-1
Connect Cable - Serial.....	3-2
Connecting an AC/DC Power Supply.....	3-3
Connecting Vehicle Power.....	3-4
DC to DC Power Supply Installation.....	3-4
Connecting Electrical Cables to Power Sources.....	3-4
Wiring Schematic.....	3-5
Connect Vehicle Electrical Connection.....	3-5
Vehicle Cradle 10.8-16VDC Direct Connection.....	3-7
Direct Vehicle Power Connection Cable (12 Ft.).....	3-7
Connect Power Cable to Vehicle.....	3-7
Input Power Specifications.....	3-7
Vehicle Cradle 24/72 Maximum VDC Input Cable Connection.....	3-8
Vehicle Power Supply, 24 - 72 Maximum VDC (Fuse Not Shown).....	3-8
Vehicle Power Supply Footprint.....	3-9
Connecting the Headset Cable.....	3-10
Connecting a Tethered Scanner.....	3-11
<b>Chapter 4: Product Agency Compliance - MX3Plus.....</b>	<b>4-1</b>
Laser Light Safety Statement.....	4-3
Lithium Battery Safety Statement.....	4-5
Vehicle Power Supply Connection Safety Statement.....	4-7
<b>Chapter 5: Technical Assistance.....</b>	<b>5-1</b>

# Chapter 1: Introduction

The MX3Plus is a rugged, portable, hand-held computer equipped mobile computer capable of wireless data communications using wireless LAN radios with internal antennas or an external remote mount antenna.

It can store information for later transmission through an RS232, InfraRed, or USB port. The MX3Plus can be scaled from a limited function batch computer to an integrated wireless scanning computer.

The keys on the keypad are constructed of a phosphorescent material that can easily be seen in dimly lighted areas.

Contact [Technical Assistance](#) for information on the latest upgrades for your MX3Plus.

## About This Guide

This MX3Plus User's Guide provides instruction for the end-user or system administrator to follow when setting up a new MX3Plus.

This user's guide has been developed for a MX3Plus with a Microsoft® Windows® CE 5 operating system.

## End User License Agreement (EULA)

When a new MX3Plus starts up a EULA is displayed on the touch screen. It remains on the screen until the Accept or Decline button is tapped with a stylus.

Tap the Accept button to accept the EULA terms and the MX3Plus continues the startup process. The EULA is not presented to the user again.

Tap the Decline button to decline the EULA and the MX3Plus will reboot. It will continue to reboot until the Accept button is tapped with the stylus.

*Note: The EULA will be presented after any operating system upgrade or re-installation, including language-specific operating systems.*

---

## Laser Warnings and Labels

- Do not look into the laser's lens.
- Do not stare directly into the laser beam.
- Do not remove the laser caution labels from the MX3Plus.
- Do not connect the laser bar code aperture to any other device. The laser bar code aperture is certified for use with the MX3Plus only.

Caution



Laser radiation when open. Please read the caution labels. Use of controls, adjustments or performance of procedures other than those specified herein may result in hazardous radiation exposure.

## Label Location

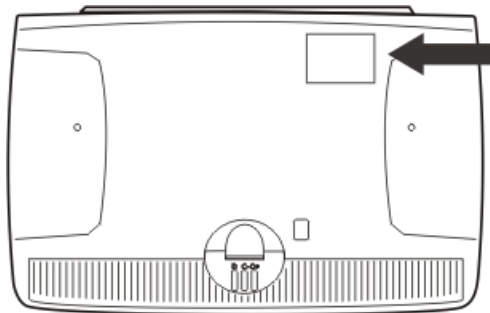

## Label

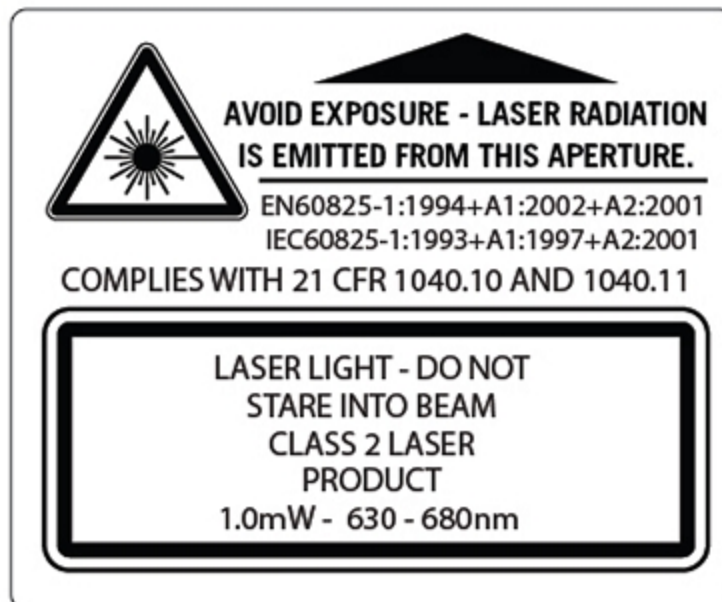

---

## Components

### Front

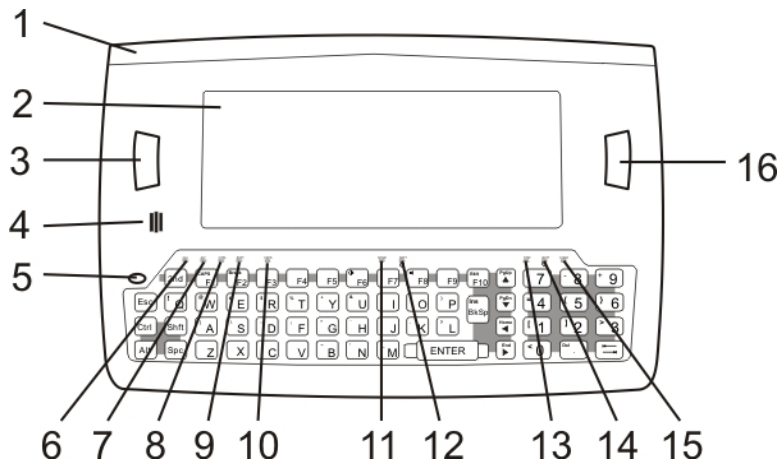

1. Endcap
2. Display
3. Scan, Enter or Field Exit (programmable)
4. Beeper
5. On / Off Button
6. 2nd LED
7. Alt LED
8. Ctrl LED
9. Shift LED
10. Caps LED
11. Scanner LED
12. Backup Battery LED
13. Status LED
14. Main Battery LED
15. Charger LED
16. Scan or Enter (programmable)

## Back

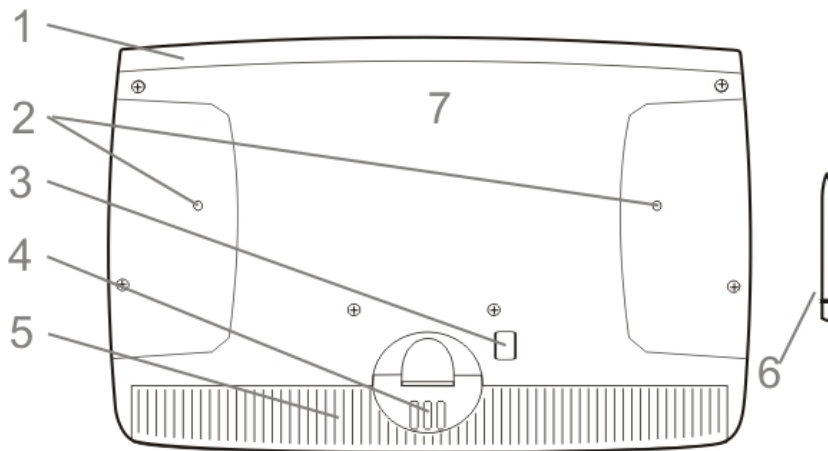

1. Endcap
2. Leather Handtrap Connector
3. IR Port (COM 2 Port)
4. Cradle Input Contacts
5. Main Battery
6. Stylus
7. Back Cover

## Endcap

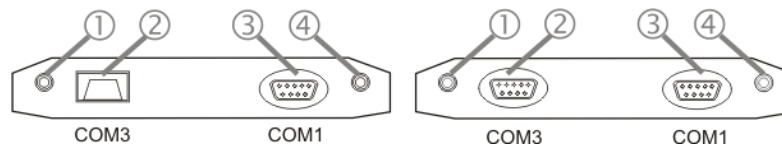

1. DC Power Jack
2. Left Port
3. Right Port (USB-C)
4. Audio Jack or External Antenna Connector

*Note: The IR port on the back of the device is COM 2.*



## Endcap Options

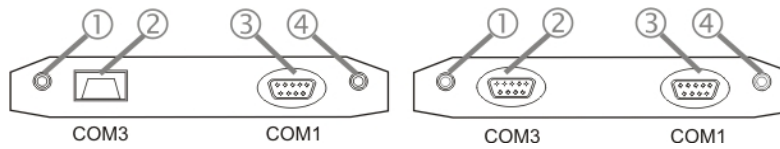

Left Port (2)	Right Port (3)	See (4)
Serial COM3	Serial COM1	Audio Jack
Serial COM3	USB Client	Audio Jack
USB Host	Serial COM1	Audio Jack
USB Host	USB Client	Audio Jack
Scanner	Serial COM1	Audio Jack
Scanner	USB Client	Audio Jack
Serial COM3	Serial COM1	Antenna
Serial COM3	USB Client	Antenna
USB Host	Serial COM1	Antenna
USB Host	USB Client	Antenna



# Chapter 2: Set Up A New MX3Plus

This page lists a quick outline of the steps you might take when setting up a new MX3Plus. More instruction for each step is listed later in this guide. Please refer to the *MX3Plus Reference Guide* for additional information and instruction.

Contact [Technical Assistance](#) if you need additional help.

*Note: Installing or removing accessories should be performed on a clean, well-lit surface. When necessary, protect the work surface, the MX3Plus, and components from electrostatic discharge.*

## Hardware Setup

1. Connect accessories.
2. [Connect cables](#).
3. [Insert/connect a fully charged battery](#)
4. Press the Power key.

## Software Setup

**Prerequisite:** Hardware setup is complete.

1. [Calibrate Touch screen](#)
2. [Set Date and Time Zone](#)
3. [Set Power Schemes Timers](#)
4. [Adjust Speaker Volume](#)
5. [Pair Bluetooth devices](#)
6. Setup Wireless client parameters
7. Setup [terminal emulation](#) parameters
8. [Save changed settings](#) to the registry
9. Setup the AppLock parameters
10. Set the Scanner Wedge parameters

Please refer to the *MX3Plus Reference Guide* for additional information and instruction.

## End User License Agreement (EULA)

When a new MX3Plus starts up a EULA is displayed on the touch screen. It remains on the screen until the Accept or Decline button is tapped with a stylus.

Tap the Accept button to accept the EULA terms and the MX3Plus continues the startup process. The EULA is not presented to the user again.

Tap the Decline button to decline the EULA and the MX3Plus will reboot. It will continue to reboot until the Accept button is tapped with the stylus.

*Note: The EULA will be presented after any operating system upgrade or re-installation, including language-specific operating systems.*

---

## Battery

### ***Connect or Remove the Battery Pack***

The MX3Plus will not function unless the battery pack is in place and securely latched.

Be sure to place the unit in Suspend Mode before removing the battery. Failing to properly place the device in Suspend mode will result in a loss of all unsaved data.

The main battery is located in a compartment on the back of the unit. The battery case serves as the back cover for the battery well of the MX3Plus.

An MX3Plus will retain data, while the main battery is removed and replaced with a fully charged main battery, for 5 minutes.

**Important:** When the internal battery power is Low or Very Low connect the AC adapter to the MX3Plus before replacing the main battery.

*Note: The battery should not be replaced in a dirty, harsh or hazardous environment. When the battery is not connected to the MX3Plus, any dust or moisture that enters the battery well or connector may transfer to the battery/well terminals, potentially causing damage.*

Warning. Only use Honeywell batteries as replacements: MX3A378BATT/158224-0001

### ***Insert/Replace Battery***

To insert the main battery, complete the following steps:

1. Place the battery in the compartment, making sure the side of the battery with six contacts matches up with the battery contacts in the battery well. Do not slide the battery sideways into the battery well.
2. Push down on the battery until the retaining clip clicks into place.

The MX3Plus draws power from the battery immediately upon successful connection.

*Note: Do not cover the vent aperture in the battery well (located in the left side of the battery well) with anything other than the main battery.*

**Check battery status** by tapping the **Start > Settings > Control Panel > Battery** icon. Main battery level, internal battery level, status and other details are displayed.

---

## ***Remove Battery***

To remove the battery, complete the following steps:

1. Place the MX3Plus in Suspend mode.
2. Detach the bottom hook of the handstrap (if installed).
3. Slide the battery retaining clip down to release the main battery.
4. Pull the battery straight up and out of the battery well.

Place the discharged battery pack in a powered battery charger.

## ***Hotswap the Main Battery***

Place the MX3Plus in Suspend Mode. Honeywell recommends any work in progress be saved prior to replacing the battery pack.

Simply replace the discharged battery with a fully-charged battery. An MX3Plus, with a fully charged internal battery, will retain data during a battery hotswap for 5 minutes.

---

## **Charge or Recharge the Main Battery**

Warning. Only use Honeywell batteries as replacements: MX3A378BATT/158224-0001

*Note: The MX3Plus Battery Charger is designed for an indoor, protected environment.*

New batteries must be fully charged prior to use.

The main battery can be recharged in an AC powered Battery Charger after the battery has been removed from the MX3Plus or its packing material when new.

The main battery while in the MX3Plus can be recharged using several different methods.

*Note: An external power source is required before the main battery in the MX3Plus will recharge.*

The main battery can be recharged while it is in the MX3Plus:

- by docking the MX3Plus in a powered desk cradle
- by docking the MX3Plus in a powered vehicle cradle

*Note: An uninterrupted external power source (wall AC adapters) transfers power to the computer's internal charging circuitry which, in turn, recharges the main battery and internal battery. Frequent connection to an external power source, if feasible, is recommended to maintain internal battery charge status as the internal battery cannot be recharged by a dead or missing main battery.*

---

## Backlights and Indicators

Across the top of the keypad are LEDs (Light Emitting Diodes) that provide visual cues to current MX3Plus operation. When the LED is not illuminated, the function is inactive.

LED	When illuminated . . .
2nd	The next keypress is a 2nd keypress. Amber when on. Blinks amber during configuration key sequence.
ALT	The next keypress is an ALT keypress. Amber when on and unlit when off.
CTRL	The next keypress is a CTRL keypress. Amber when on and unlit when off.
SHFT	The next letter is the uppercase letter on alpha keys and the shifted character on the numeric keypad keys. Amber when on and unlit when off.
CAPS	Uppercase letters are active until the CAPS key sequence is pressed again. Amber when on and unlit when off.
STAT	Status Indicator. Amber when device is booting up. Blinking Green when display Suspend state begins.
SCNR	Bar code scanner function, affected by both tethered scanners and the scanner endcap. <ul style="list-style-type: none"><li>• Red - scanning.</li><li>• Green - good scan.</li><li>• Unlit - scanner is inactive.</li></ul>
BATT B	Backup Battery. When illuminated, the backup battery is charging. When unlit, the backup battery is not charging.
BATT M	Main Battery. When illuminated, main battery capacity is low. <ul style="list-style-type: none"><li>• Red – low battery.</li><li>• Blinking Red – power fail.</li><li>• Unlit - Main battery is not low OR all charge is depleted in both batteries.</li></ul>
CHGR	Charger. When on, the MX3Plus is receiving external power either from the DC power jack or the MX3Plus is seated in a powered cradle. <ul style="list-style-type: none"><li>• Red - Main battery is charging.</li><li>• Amber – Fault or temporary standby (Contact <a href="#">Technical Assistance</a>).</li><li>• Green - battery charge is complete and the MX3Plus is connected to external power through the power jack or a powered cradle.</li></ul>

---

## Tapping the Touch Screen with a Stylus

*Note:* Always use the point of the stylus for tapping or making strokes on the touch screen.

**Never use an actual pen, pencil, or sharp/abrasive object to write on the touch screen.**

Hold the stylus as if it were a pen or pencil. Touch an element on the screen with the tip of the stylus then remove the stylus from the screen.

Firmly press the stylus into the stylus holder when the stylus is not in use.

Using a stylus is similar to moving the mouse pointer then left-clicking icons on a desktop computer screen.

Using the stylus to tap icons on the touch screen is the basic action that can:

- Open applications
- Choose menu commands
- Select options in dialog boxes or drop-down boxes
- Drag the slider in a scroll bar
- Select text by dragging the stylus across the text
- Place the cursor in a text box prior to typing in data
- Place the cursor in a text box prior to retrieving data using a scanner/imager or an input/output device connected to a serial port.

A right-click can be simulated by touching the touch screen with the stylus and holding it for a short time.

A stylus replacement kit is available.



---

## Touch Screen

### *Calibrating the Touch Screen*

If the touch screen is not responding properly to stylus taps, you may need to recalibrate the touch screen.

Recalibration involves tapping the center of a target. If you miss the center, keep the stylus on the screen, slide it over the target's center, and then lift the stylus.

To recalibrate the screen, select **Start > Settings > Control Panel > Stylus > Calibration** tab.

To begin, tap the Recalibrate button on the screen with the stylus.

Follow the instructions on the screen and press the Enter key to save the new calibration settings or press Esc to cancel or quit.

### *Adjusting the Display Backlight Timer*

**Start > Settings > Control Panel > Display > Backlight**

The backlight settings use the Honeywell set of default timeouts and are synchronized to the User Idle setting in the Schemes tab in the Power control panel.

When the backlight timer expires, the display backlight is dimmed, not turned off. When both checkboxes are unchecked, the backlight never turns off (or dims).

Default values are 3 seconds for Battery, 2 minutes for External and both the check boxes are enabled.

### *Apply the Touch Screen Protective Film*

First, [clean the touch screen](#) of fingerprints, lint particles, dust and smudges.

Remove the protective film from its container. Remove any protective backing from the film sheet by lifting the backing from a corner of the film. Discard the backing.

Apply the film to the touch screen starting at one side and smoothing it across the display. If air bubbles appear, raise the film slightly and continue smoothing the film across the display until it covers the glass surface of the display. If dust, lint or smudges are trapped between the protective film and the glass display, remove the protective film, clean the display and apply the protective film again.

Contact [Technical Assistance](#) about protective film packs designed specifically for your MX3Plus touch screen.

---

## Using the Input Panel / Virtual Keyboard

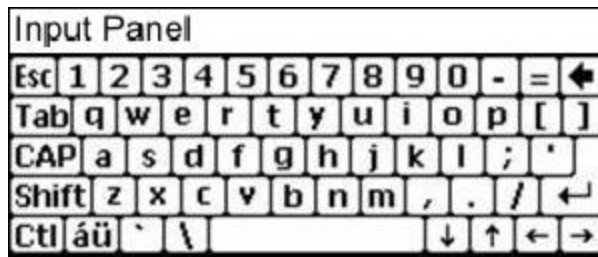

The virtual keyboard is always available when needed e.g., text entry.

Place the cursor in the text entry field and, using the stylus:

- Tap the Shift key to type one capital letter.
- Tap the CAPS key to type all capital letters.
- Tap the áü key to access symbols.

Some applications do not automatically display the Input Panel. In this case, do the following to use the Input Panel:



Input Panel icon in the taskbar



Keyboard icon in the taskbar

- Tap the Input Panel or Keyboard icon in the taskbar.
- Select **Keyboard** from the menu.
- Move the cursor into the text entry field when you want to enter data using the Input Panel.

When finished entering data, tap the icon in the Taskbar again. Select **Hide Input Panel**.

---

## Set Date and Time Zone

Tap **Start > Settings > Control Panel > Date/Time** icon or tap the Date/Time in the taskbar.

Set Date, Time, Time Zone, and assign a Daylight Savings location on the MX3Plus after a warm boot or anytime.

There is very little functional change from standard desktop PC Date/Time Properties options. Adjust the settings and tap the OK button or the Apply button to save changes to the registry. Any changes take effect immediately.

Double-tapping the time displayed in the Taskbar causes the Date/Time Properties screen to appear.

## *Grab Time Utility*

The GrabTime utility can be configured to synchronize the time with a local server during each reboot function.

Tap the Sync button to synchronize date and time with a networked time server. By default, the MX3Plus operating system first searches for a time server on the local intranet. If not found, it then searches the Internet for a time server. A connection to the Internet is required for this option.

## *Autolaunch Time-Sync*

**Start > Settings > Control Panel > MX3Plus Options > Communication tab**

By default, TimeSync does not automatically run on the MX3Plus. To enable TimeSync to run automatically on the MX3Plus using the GrabTime utility, check this checkbox.

## *Synchronize with a Local Time Server*

By default, GrabTime synchronizes via an Internet connection. To synchronize with a local time server:

1. Use ActiveSync to copy GrabTime.ini from the My Device > Windows folder on the MX3Plus to the host PC.
2. Edit the copy of GrabTime.ini on the host PC. Add the local time server's domain name to the beginning of the list of servers. You can optionally delete the remainder of the list.
3. Copy the modified GrabTime.ini file to the My Device > System folder on the MX3Plus. The System/GrabTime.ini file takes precedence over the Windows/GrabTime.ini file. System/Grabtime.ini also persists after a coldboot; Windows/Grabtime.ini does not persist.

---

## Set Power Scheme Timers

Start > Settings > Control Panel > Power > Schemes

Change the parameter values and tap OK to save the changes.

User Idle	An amount of time has passed, set by the User Idle timer, and the device shuts down a minimum number of services e.g., backlights. The System Idle timer and the Suspend timer have not expired yet.
System Idle	An amount of time has passed, set by the System Idle timer, and the device shuts down a few more services e.g., display. The User Idle timer has expired and the Suspend timer has not expired yet.
Suspend	Suspend mode is entered when (1) the unit is inactive for a predetermined period of time, (2) the user taps the Power key, or (3) Start > Suspend is chosen. Inactivity means that internal devices that reset the power state are not active.

### Battery Power Scheme

Use this option when the MX3Plus will be running on battery power only.

Switch state to User Idle	Default is After 3 seconds
Switch state to System Idle	Default is After 15 seconds
Switch state to Suspend	Default is After 5 minutes

### AC Power Scheme

Use this option when the MX3Plus will be running on external power (e.g., connected to an A/C power source).

Switch state to User Idle	Default is After 2 minutes
Switch state to System Idle	Default is After 2 minutes
Switch state to Suspend	Default is After 5 minutes

The timers are cumulative. The System Idle timer begins the countdown after the User Idle timer has expired and the Suspend timer begins the countdown after the System Idle timer has expired. When the User Idle timer is set to "Never", the power scheme timers never place the MX3Plus in User Idle, System Idle or Suspend modes (even when the MX3Plus is idle).

Using the Battery Power Scheme Defaults listed above, the cumulative effect results in the following:

- The backlight turns off after 3 seconds of no activity,
- The display turns off after 18 seconds of no activity (15 seconds + 3 seconds),
- And the MX3Plus enters Suspend after 5 minutes and 18 seconds of no activity.

---

## Adjust Speaker Volume

The speaker, also called the beeper, is located below the left scan button.

Speaker volume can be adjusted to a comfortable level for the listener by using the keypad or by changing parameters in the Volume & Sounds control panel.

### *Using the Keypad*

*Note:* Volume & Sounds (in Settings > Control Panel) must be enabled before the following key sequences can adjust the volume.

The volume is increased or decreased one step each time the volume key sequence is pressed.

To adjust speaker volume, locate the F8 key at the top of the keypad.

Adjust the speaker volume by pressing the:

- 2nd key then the F8 key to enter Volume change mode.
- Use the Up Arrow and Down Arrow keys to adjust volume until the speaker volume is satisfactory. Press the Enter key to exit this mode.

The LED for the 2nd key blinks until the special editing mode (set audio speaker volume) is complete.

Volume control using a keypad key press has six volume settings that match those supported by the Volume and Sounds Control panel. Volume does not “roll-over” from minimum to maximum or from maximum to minimum. Continuously holding down the up or down arrow keys does not cause an automatic repeat of the up (or down) arrow key.

### *Using the Control Panel*

**Start > Settings > Control Panel > Volume & Sounds > Volume**

Change the volume setting and tap OK to save the change.

You can also select / deselect sounds for key clicks and screen taps and whether each is loud or soft.

As the volume scroll bar is moved between Loud and Soft, the MX3Plus emits a tone each time the volume increases or decreases in decibel range.

---

## Setup Terminal Emulation Parameters

Before you make a host connection, you will, at a minimum, need to know:

- the alias name or IP address (Host Address) and
  - the port number (Telnet Port) of the host system to properly set up your host session.
1. Make sure the mobile client network settings are configured and functional. If you are connecting over wireless LAN (802.11x), make sure your mobile client is communicating with the Access Point.
  2. From **Start > Program**, run **RFTerm** or tap the RFTerm icon on the desktop.
  3. Select **Session > Configure** from the application menu and select the "host type" that you require. This will depend on the type of host system that you are going to connect to; i.e., 3270 mainframe, AS/400 5250 server or VT host.
  4. Enter the "Host Address" of the host system that you wish to connect to. This may either be a **DNS name or an IP address of the host** system.
  5. Update the **telnet port number**, if your host application is configured to listen on a specific port. If not, just use the default telnet port.
  6. Select **OK**.
  7. Select **Session > Connect** from the application menu or tap the "Connect" button on the Tool Bar. Upon a successful connection, you should see the host application screen displayed.

To change options such as Display, Colors, Cursor, Bar Code, etc., please refer to these sections in the *RFTerm Reference Guide* for complete descriptions of these and other features.

---

## Using the AppLock Switchpad

*Note:* The touch screen must be enabled. Select **Start > Settings > Control Panel > Options > Misc. tab** to verify touch screen status.

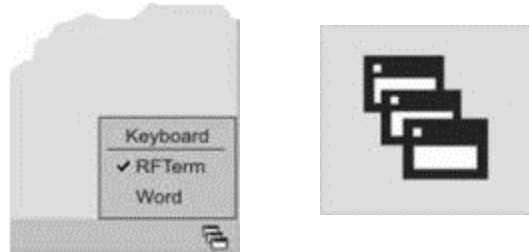

Click the switchpad icon in the taskbar.

A checkmark on the switchpad menu indicates applications currently active or available for Launching by the MX3Plus user. When Keyboard, on the Switchpad Menu, is selected, the default input method (Input Panel, Transcriber, or custom input method) is activated.

## Using the Keypad

One switch key sequence (or hotkey) is defined by the Administrator for the end-user to use when switching between locked applications. This is known as the **Activation key**.

When the switch key sequence is pressed on the keypad, the next application in the AppLock configuration is moved to the foreground and the previous application moves to the background. The previous application continues to run in the background. MX3Plus key presses affect the application in focus only.

## Using the Touch Screen

The figure shown above is an example and is shown only to aid in describing how the user can switch between applications using a stylus.

When the user taps the Switchpad icon with the stylus, a menu pops up listing the applications available to the user. The user can tap an application name in the popup menu and the selected application is brought to the foreground. The previous application continues to run in the background. Stylus taps affect the application in focus only. When the user needs to use the Input Panel, they tap the Keyboard option. Input Panel taps affect the application in focus only.

---

## Connecting Bluetooth Devices

Before connecting to Bluetooth Devices:

- The system administrator has discovered, paired, connected and disconnected (using LXEZ Pairing Control Panel) Bluetooth devices for each MX3Plus.
- The system administrator has enabled and disabled LXEZ Pairing parameters for the MX3Plus.
- The system administrator has also assigned a Computer Friendly Name using LXEZ Pairing Control Panel for the MX3Plus.



To connect Bluetooth devices, the MX3Plus should be as close as possible and in direct line of sight (distances up to 32.8 feet or 10 meters) with the targeted Bluetooth device during the discovery and pairing process.

If the devices are in Suspend, tap the power key to wake the MX3Plus.

Using the correct procedure, wake the targeted Bluetooth device if necessary.

There may be audible or visual signals as both devices discover and pair with each other.

### ***Taskbar Connection Indicator***

	MX3Plus is connected to one or more of the targeted Bluetooth device(s).
	MX3Plus is not connected to any Bluetooth device. MX3Plus is ready to connect with any Bluetooth device. MX3Plus is out of range of all paired Bluetooth device(s). Connection is inactive.

There may be audible or visual signals from paired devices as they move back into range and re-connect with the Bluetooth hardware in the MX3Plus.



---

## Reboot

When the Windows desktop is displayed or an application begins, the power up (or reboot) sequence is complete.

### ***Warm Boot***

#### **Start > Run**

The Warm Boot function refreshes the Windows operating system without clearing RAM or deleting installed programs. User-set parameters are unchanged.

Tap **Start > Run** and type WARMBOOT.EXE or WARMBOOT. This command is not case sensitive. Tap the OK button. This process takes less than 15 seconds. Temporary data not saved is lost.

*Note: There may be slight delays while the wireless client connects to the network, re-authorization for voice-enabled applications completes, Wavelink Avalanche management of the MX3Plus startup completes, or Bluetooth relationships establish or re-establish.*

### ***Cold Boot***

#### **Start > Run**

The Cold Boot function reboots the device, erases all registry data, and user-specified settings. The factory default settings are restored when the MX3Plus powers on again.

Passwords are lost upon cold boot. If a password is set, that password must be entered to begin the cold boot power cycle process.

Tap **Start > Run** and type COLDBOOT.EXE or COLDBOOT. This command [is not case-sensitive](#)<sup>1</sup>. Tap the OK button.

*Note: Because of the extreme nature of cold boot, Honeywell recommends using this command only as an emergency (or when instructed to do so as part of a specific MX3Plus procedure).*

---

<sup>1</sup>The text typed in the text box can be upper or lower case or a combination of upper and lower case letters.

---

## Attaching the Handstrap

*Note: The handstrap is pre-installed.*

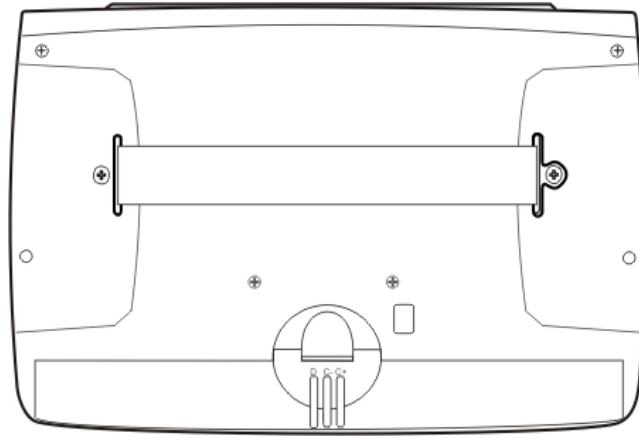

1. Place the MX3Plus with the screen facing down, on a flat stable surface.
2. Attach the handstrap retainer bracket to the MX3Plus with the screws and washers provided.
3. Fold each end of the strap over so that the closed loop fastener surfaces mate evenly.
4. Test the strap's connection making sure the MX3Plus is securely connected to each end of the handstrap's connectors.

Check the closed loop fastener, retainer bracket and clip connections frequently. If they have loosened, they must be tightened or replaced before the MX3Plus is placed into service again.

---

## ***Attach Stylus Tether and Sleeve***

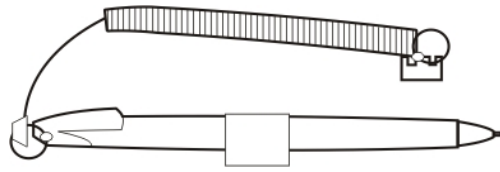

The stylus kit includes the stylus, tether and sleeves. The tether allows the stylus to be mounted to the MX3Plus and the sleeve provides storage for the stylus when not in use.

Determine a convenient location for the stylus sleeve.

Carefully remove the paper backing from the Stylus Clip sticky. Firmly press the sticky side of the clip onto the MX3Plus and hold it in place for 15 seconds. Thread the tether through the end of the stylus and tie the ends firmly to the Stylus Clip so that the ends don't interfere with placing the stylus in the Stylus Clip. Place the stylus in the Stylus Clip when not in use. An extra or replacement stylus can be ordered from Honeywell.

---

## Adjust Headset / Microphone and Secure Cable



The headset consists of an earpiece, a microphone, a clothing clip and a cable. The headset attaches to the audio cable end of the voice cable which attaches to the MX3Plus.

Align the audio connector and the headset quick connect cable end. Firmly push the cable ends together until they click and lock in place.

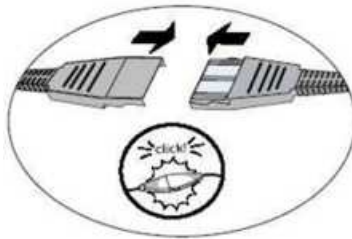

Do not twist the microphone boom when adjusting the microphone. The microphone should be adjusted to be about two finger widths from your mouth.

Make sure the microphone is pointed at your mouth. Note the small "Talk" label near the mouthpiece. Make sure the Talk label is in front of your mouth. The microphone cable can be routed over or under clothing.

### Under Clothing

- Leave the cable exposed only at the top of the collar.
- Be sure to leave a small loop of cable to allow movement of your head.

### Over Clothing

- Use clothing clips to hold the cable close to your body.
- Tuck the cable under the belt, but leave a small loop where it goes under the belt.
- Do not wear the cable on the front of your body. It may get in your way or get caught on protruding objects.

---

## Cleaning the Touch Screen and Scanner Aperture

*Note: These instructions are for components made of glass. If there is a removable protective film sheet on the display, remove the film sheet before cleaning the screen.*

Keep fingers and rough or sharp objects away from the bar code reader scanning aperture and the mobile device touch screen.

If the glass becomes soiled or smudged, clean only with a standard household cleaner such as Windex® without vinegar or use Isopropyl Alcohol. Dampen the cloth with the cleaner and then wipe the surface.

Do not use paper towels or harsh-chemical-based cleaning fluids since they may result in damage to the glass surface. Use a clean, damp, lint-free cloth.

Do not scrub optical surfaces. If possible, clean only those areas which are soiled. Lint and particulates can be removed with clean, filtered canned air.

---

## Startup Help

Contact [Technical Assistance](#) if you need more help.

Can't change the date/time or adjust the volume.	AppLock is installed and may be running in User Mode on the MX3Plus. AppLock user mode restricts access to the control panels.
Touch screen is not accepting stylus taps or needs recalibration.	<a href="#">See Also: "Calibrating the Touch Screen"</a> when the touch screen needs recalibration, or Press Ctrl+Esc to force the Start Menu to appear. Use the tab, backtab and arrow keys to move the cursor from element to element.
MX3Plus seems to lockup as soon as it is rebooted.	There may be slight delays while the wireless client connects to the network, authorization for voice-enabled applications complete, Wavelink Avalanche management of the MX3Plus startup completes, and Bluetooth relationships establish or re-establish. When the desktop appears or an application begins, the MX3Plus is ready for use.
New MX3Plus main batteries don't last more than a few hours.	New batteries must be fully charged prior to first use. Li-Ion batteries (like all batteries) gradually lose their capacity over time (in a linear fashion) and never just stop working. This is important to remember – the MX3Plus is always 'on' even when in the Suspend state and draws battery power at all times.

## ***Continuous Scan Mode***

If Continuous Scan Mode has been enabled (factory default setting is 'Disabled'), the laser (or imager) is always on and decoding.

Caution: Laser beam is emitted continuously. Do not stare into the laser beam.

# Chapter 3: Connecting Cables to the MX3Plus

## Connect Cable - USB Host

*Note:* An endcap with a USB Host port (labeled USB-H) must be available.

### USB-H Cable Assembly

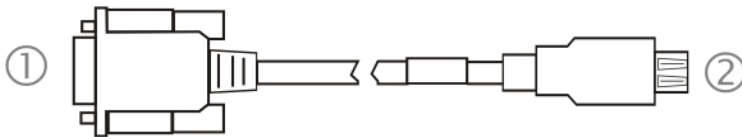

1. Connect to MX3Plus serial port
2. Host USB port

1. Seat the cable end connector (connector 1) firmly over the USB-C port on the MX3Plus endcap.
2. Tighten the thumbscrews in a clockwise direction. Do not over tighten.
3. Connector 2 on the cable provides a USB-Host connection.

## Connect Cable - USB Client

*Note:* An endcap with a USB Client port (labeled USB-C) must be available.

### USB-C Cable Assembly



1. Connect to MX3Plus serial port
2. Connect to host USB port

1. Seat the cable end connector (connector 1) firmly over the USB-C port on the MX3Plus endcap.
2. Tighten the thumbscrews in a clockwise direction. Do not over tighten.
3. Connector 2 on the cable provides a USB-Client connection.

---

## Connect Cable - Serial

*Note: An endcap with a serial port (labeled RS232) must be available.*



1. Seat the cable end connector firmly over the serial COM port on the endcap.
2. Turn the thumbscrews in a clockwise direction. Do not over tighten.
3. Use a strain relief clamp to secure the cable to the MX3Plus.
4. Connect the other cable end to the desired serial device.



---

## Connecting an AC/DC Power Supply

*Note: The Honeywell-approved AC Power Supply and Adapter Cable are only intended for use in a 25°C (77°F) maximum ambient temperature environment.*

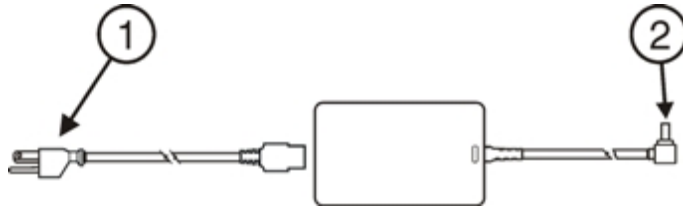

1. AC Input Cable (US only)
2. DC Output Cable

In North America, this unit is intended for use with a UL Listed ITE power supply with output rated 12 – 80VDC, minimum 15W. Outside North America, this unit is intended for use with an IEC certified ITE power supply with output rated 12 – 80VDC, minimum 15W.

The external power supply may be connected to either a 120V, 60Hz supply or, outside North America, to a 230V, 50Hz supply, using the appropriate detachable cordset. In all cases, connect to a properly grounded source of supply provided with maximum 15 Amp overcurrent protection (10 Amp for 230V circuits).

1. Turn the MX3Plus off.
2. Connect the detachable cordset provided by Honeywell (US only, all others must provide their own cable) to the external power supply (IEC 320 connector).
3. Plug cordset into appropriate, grounded, electrical supply receptacle (AC mains).
4. Insert the barrel connector end of the AC/DC 12V power supply adapter into the power jack on the MX3Plus endcap and push in firmly.
5. The CHGR LED above the keypad illuminates when the MX3Plus is receiving external power through the power jack.
6. Turn the MX3Plus on.

---

## Connecting Vehicle Power

Complete vehicle cradle mounting and power instruction is contained in the *MX3Plus Cradle Guide*.

The MX3Plus must have a main battery installed before docking the MX3Plus in a cradle.

## DC to DC Power Supply Installation

For use with Honeywell power supplies:

- 9000301PWRSPPLY – Power Supply, 18-60VDC with cable
- 9000302PWRSPPLY – Power Supply, 60-110VDC with cable



## Connecting Electrical Cables to Power Sources

The DC to DC power supply is used to provide vehicle power to the MX3Plus when placed in a DC powered vehicle dock.

### Specifications for Electrical Supply

Input Voltage	Always observe input voltage range specified on the DC to DC power supply
Output Voltage	12 VDC $\pm$ 10%
Power	60 W
Fuse	5 A (slow blow fuse). Fuses are USER SUPPLIED

*Note:* Refer to the [Wiring Schematic](#) for wiring colors and connections.

Caution: 	For proper and safe installation, the input power cable must be connected to a fused circuit on the vehicle. This fused circuit requires a five Amp maximum time delay (slow blow) high interrupting rating fuse. If the supply connection is made directly to the battery, the fuse should be installed in the positive lead within 5 inches of the battery positive (+) terminal. Note: For North America, a UL Listed fuse is to be used.
Caution: 	For installation by trained service personnel only.
Warning: 	Risk of ignition or explosion. Explosive gas mixture may be vented from battery. Work only in well ventilated area. Avoid creating arcs and sparks at battery terminals.

## Wiring Schematic

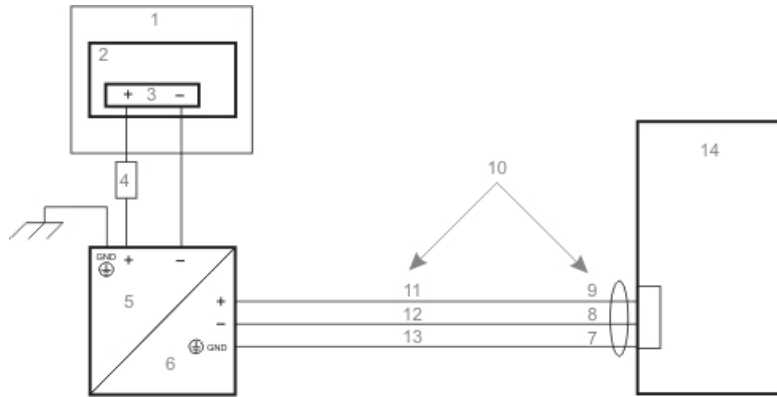

1. Existing Circuitry on Vehicle
2. Forklift Battery
3. Main Switch
4. 5A slow fuse close to power source
5. Power input
6. Isolated DC power output
7. Green
8. Red / Black
9. Red / White
10. Use color scheme corresponding to input wire provided
11. Brown
12. Blue
13. Green
14. Vehicle mounted cradle

## Connect Vehicle Electrical Connection

1. The vehicle cradle must be empty.
2. Begin by connecting the power cable to the MX3Plus's vehicle cradle. Work from this connection with the last connection being to the vehicle's power source.
3. Route the cable from the cradle to the DC to DC converter.
4. Cut the cable to length and strip the wire ends.  
Route the power cable the shortest way possible. The cable is rated for a maximum temperature of 105°C (221°F). When routing this cable it should be protected from physical damage and from surfaces that might exceed this temperature. Do not expose the cable to chemicals or oil that may cause the wiring insulation to deteriorate. If the vehicle is equipped with a panel containing Silicon Controller Rectifiers (SCR's), avoid routing the power cable in close proximity to these devices. Always route the cable so that it does not interfere with safe operation and maintenance of the vehicle.
5. Remove the DC to DC converter lid screws. Put them in a safe place.
6. Remove the lid from the DC to DC converter.
7. Attach the stripped wire ends to the **output** side of the DC to DC converter.
8. Attach the stripped wire ends to the **input** side of the DC to DC converter.
9. The input and output blocks each have two + plus and two – minus connectors. Either connector in the block can be used to connect the matching polarity wire. The input and output blocks also each have two chassis ground connections. When connecting the MX3Plus cradle to vehicle power, use one chassis ground connector in each block.

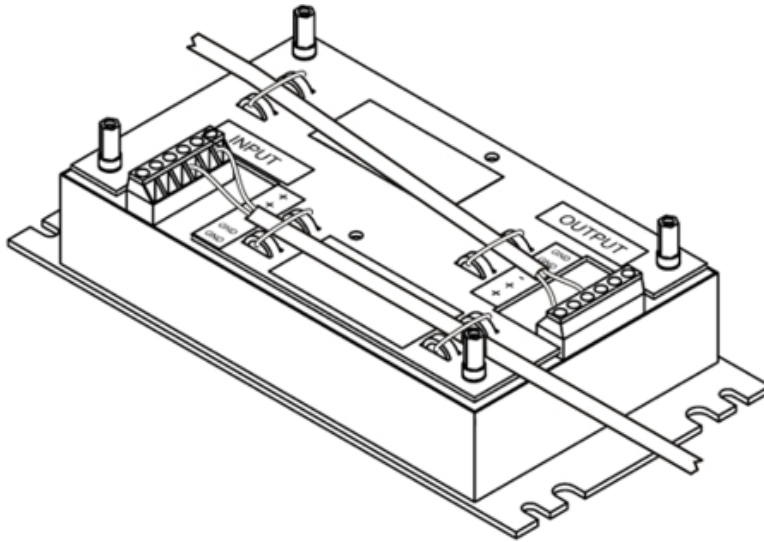

10. Wire colors depend on the type of device attached. Please refer to [this illustration](#) for wire colors.
11. Use the looms and wire ties to secure all wiring as shown above, then reattach the cover with the screws.
12. Connect the DC to DC converter to the vehicle's electrical system.
13. While observing the fuse requirements specified [here](#), connect the power cable as close as possible to the actual battery terminals of the vehicle. When available, always connect to unswitched terminals in the vehicle fuse panel, after providing proper fusing.  
*Note: ATTENTION: For uninterrupted power, electrical supply connections should not be made at any point after the ignition switch of the vehicle.*
14. Use proper electrical and mechanical fastening means for terminating the cable. Properly sized "crimp" type electrical terminals are an accepted method of termination. Please select electrical connectors sized for use with 18AWG (1mm<sup>2</sup>) conductors.
15. Provide mechanical support for the cable by securing it to the vehicle structure at approximately one foot intervals, taking care not to over tighten and pinch conductors or penetrate outer cable jacket.

## Vehicle Cradle 10.8-16VDC Direct Connection

### Direct Vehicle Power Connection Cable (12 Ft.)

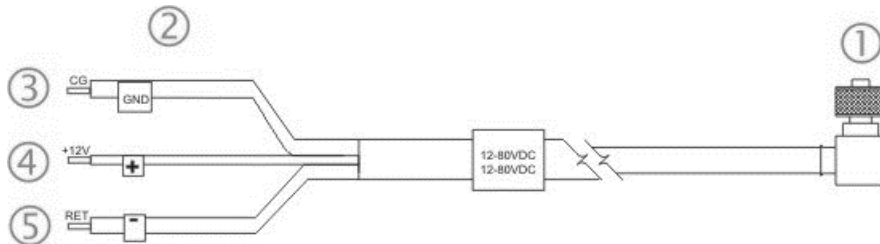

1. To Vehicle Mounted Device
2. To Vehicle Battery
3. Green (Ground)
4. Red / White (12V +)
5. Red / Black (Return)

### Connect Power Cable to Vehicle

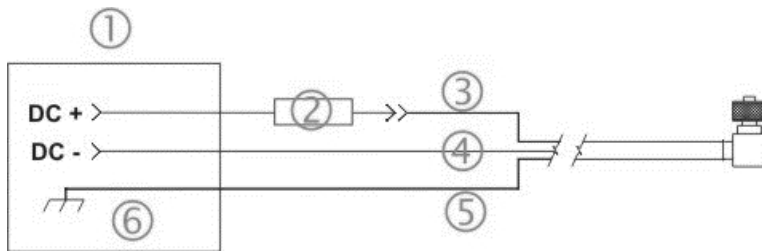

1. Vehicle Electrical System
2. 5 Amp Slow Blow Fuse
3. Red / White
4. Red / Black
5. Green
6. Vehicle Chassis

**Note:** Correct electrical polarity is required for safe and proper installation. Connecting the cable to the vehicle cradle with the polarity reversed will cause the vehicle cradle fuse to be blown. See the following table for wire color-coding specifics.

Wiring color codes for Honeywell supplied DC input power cabling:

Vehicle Supply	Wire Color
+10.8 - 16VDC (DC +)	Red with White Stripe
Return (DC -)	Red with Black Stripe
Vehicle Chassis (GND)	Green

### Input Power Specifications

Part Number: 9000A079CBL12ML3

Feature	Specification
DC Input Voltage	10.8 - 16VDC
Input Current	1.25 Amps
Input Fuse	5A Time Delay

## Vehicle Cradle 24/72 Maximum VDC Input Cable Connection

**Caution**



For proper and safe installation, the input power cable must be connected to a fused circuit on the vehicle. This fused circuit requires a 5 Amp maximum time delay (slow blow) fuse. If the supply connection is made directly to the battery, the fuse should be installed in the positive lead within 5 inches of the battery positive (+) terminal. Recommended for vehicle electrical systems that use between 2 and 5 twelve volt batteries in series.

## Vehicle Power Supply, 24 - 72 Maximum VDC (Fuse Not Shown)

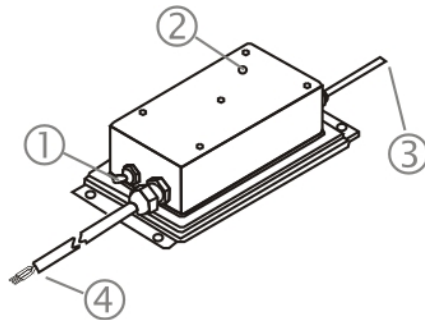

1. Power Switch
2. Power On Indicator
3. Output to Vehicle Cradle
4. Input from Vehicle Battery

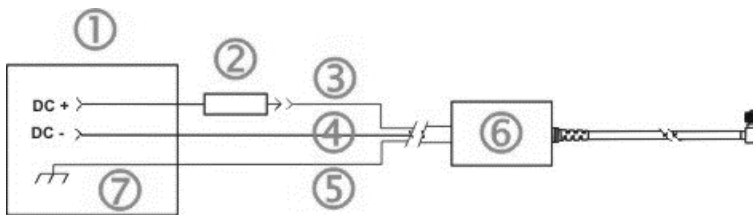

1. Vehicle Electrical System
2. 5 Amp Slow Blow Fuse
3. Brown or White
4. Blue or Black
5. Green
6. DC-DC Converter
7. Vehicle Chassis

Part Number: 9000A316PS24V72MX13 (Replaces 1300A301PS24WW).

---

## Vehicle Power Supply Footprint

### Power Supply Dimensions

Length: 9.25" / 23.5 cm

Height: 2.5" / 6 cm

Width: 4.7" / 12 cm

### Mounting hole center

Width: 3.5" / 9 cm

Length: 8.75" / 22.2 cm

1. If the MX3Plus is in the cradle, it can be either On or Off during this process.
2. Turn the Power Supply toggle switch to the Off position.
3. While observing the fuse requirements specified above, connect the power cable as close as possible to the actual battery terminals of the vehicle. When available, always connect to un-switched terminals in the vehicle fuse panel, after providing proper fusing.

### **IMPORTANT:**

**For uninterrupted power, electrical supply connections should not be made at any point after the ignition switch of the vehicle.**

4. Route the cable the shortest way possible. The input cable from the connection to the battery is rated for a maximum temperature of 60°C (140°F). When routing this cable it should be protected from physical damage and from surfaces which might exceed this temperature.

Additionally do not expose the cable to chemicals or oil that may cause the wiring insulation to deteriorate.

*Note: If the vehicle is equipped with a panel containing Silicon Controlled Rectifiers (SCR's), avoid routing the power cable in close proximity to these devices.*

Always route the cable so that it does not interfere with the driver's safe operation and maintenance of the vehicle.

Use proper electrical and mechanical fastening means for terminating the cable. Properly sized "crimp" type electrical terminals are an accepted method of termination.

Wiring color codes for Honeywell supplied DC input power cabling:

Vehicle Supply		Wire Color
+24-72 Max VDC	(DC +)	Brown or White
Return	(DC -)	Blue or Black
Vehicle Chassis	(GND)	Green

*Note: The input power cord for the DC-DC Power Supply uses white, black and green wires. Some Honeywell products have DC input power cords with brown, blue and green wires. The previous table shows the correct electrical connection for either type of cable.*

5. Provide mechanical support for the cable by securing it to the vehicle structure at approximately one foot intervals, taking care not to over tighten and pinch conductors or penetrate outer cable jacket.
6. Connect the Power Supply to the cradle by aligning the keyed water tight connector pins to the power connector; push down on the keyed water tight connector and twist it to fasten securely.
7. Turn the Power Supply on. The ON LED on the Power Supply illuminates when it is receiving power from the vehicle.
8. The Cradle Status LED illuminates green.
9. The MX3Plus CHGR LED illuminates.

---

## Connecting the Headset Cable

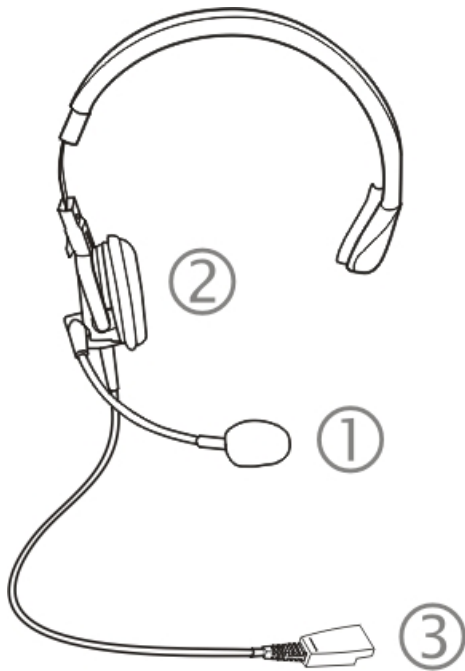

### Headset

1. Microphone
2. Headphones
3. Connects to voice cable end of voice cable

Connect the MX3Plus voice cable I/O connector to the I/O port on the MX3Plus. The MX3Plus internal microphone and speaker are automatically disabled.

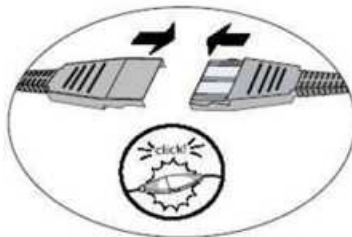

Slide the voice cable ends together until they click shut. Do not twist or bend the connectors. The MX3Plus is ready for voice-enabled applications.



---

## Connecting a Tethered Scanner

Do not connect a tethered scanner cable to a USB-C or USB-H labeled endcap port. The USB ports cannot power a tethered scanner. The tethered scanner draws power from the MX3Plus.

The MX3Plus Scan buttons have no effect on tethered bar code scanners (connected to a serial port). Tethered scanners read bar code scans only when the trigger on the tethered scanner is pressed. The tethered scanner requires power on pin 9 of the MX3Plus's serial port.

To set the MX3Plus to use a tethered scanner, select Start > Settings > Control Panel > Scanner > COM1 (or 2 or 3). Tap the "Power on Pin 9 (+5V)" checkbox for the COM port selected. The COM port that accepts the scanner data can be configured for data rate, parity, stop bits and data bits.



# Chapter 4: Product Agency Compliance - MX3Plus

## ***Class A Digital Device***

### **FCC Rules, Part 15**

This device complies with FCC Rules, part 15. Operation is subject to the following two conditions:

1. This device may not cause harmful interference, and
2. This device must accept any interference received, including interference that may cause undesired operation.

NOTE: This equipment has been tested and found to comply with the limits for a Class A digital device, pursuant to Part 15 of the FCC Rules. These limits are designed to provide reasonable protection against harmful interference when the equipment is operated in a commercial environment. This equipment generates, uses, and can radiate radio frequency energy and, if not installed and used in accordance with the instruction manual, may cause harmful interference to radio communications.

Operation of this equipment in a residential area is likely to cause harmful interference in which case the user will be required to correct the interference at his own expense.

### **Notice**

Changes or modifications made to this equipment not expressly approved by Honeywell may void the FCC authorization to operate this equipment.

### **Industry Canada**

This Class A digital apparatus meets all requirements of the Canadian Interference Causing Equipment Regulations. Operation is subject to the following two conditions: (1) this device may not cause harmful interference, and (2) this device must accept any interference received, including interference that may cause undesired operation. Cet appareil numérique de la classe A respecte toutes les exigences du Règlement sur le matériel brouilleur du Canada. Le présent appareil numérique n'émet pas de bruits radioélectriques dépassant les limites applicables aux appareils numériques de Classe A prescrites dans le Règlement sur le brouillage radioélectrique édictés par le ministère des Communications du Canada.

### **EMC Directive Requirements:**

This is a Class A product. In a domestic environment this product may cause radio interference in which case the user may be required to take adequate measures.

### **Li-Ion Battery**

When disposing of the MX3Plus main battery, the following precautions should be observed: The battery should be disposed of properly. The battery should not be disassembled or crushed. The battery should not be heated above 212°F (100°C) or incinerated.

---

## RF Notices

This device contains transmitter Module FCC ID: KDZLXE4830P

This device contains transmitter Module FCC ID: KDZLXE4831P

### RF Safety Notice (Summit Client - 4830)

Caution:



This portable device with its antenna complies with FCC and Industry Canada RF exposure limits set for an uncontrolled environment. This equipment has shown compliance with FCC and Industry Canada Specific Absorption Rate (SAR) limits. Highest reported SAR for the MX3Plus is 1.176W/kg on body. Any accessories not provided by Honeywell should not be used with this device. This device must not be co-located or operating in conjunction with any other antenna or transmitter.

### RF Safety Notice (Summit Client - 4831)

Caution:



This portable device with its antenna complies with FCC and Industry Canada RF exposure limits set for an uncontrolled environment. This equipment has shown compliance with FCC and Industry Canada Specific Absorption Rate (SAR) limits. Highest reported SAR for the MX3Plus is 0.543W/kg on body. Any accessories not provided by Honeywell should not be used with this device. This device must not be co-located or operating in conjunction with any other antenna or transmitter.

## Waste Electrical and Electronic Equipment (WEEE)



Important:

This symbol is placed on the product to remind users to dispose of Waste Electrical and Electronic Equipment (WEEE) appropriately, per Directive 2002-96-EC. In most areas, this product can be recycled, reclaimed and re-used when properly discarded. Do not discard labeled units with trash. For information about proper disposal, visit [www.honeywellaidc.com](http://www.honeywellaidc.com).

## R&TTE Directive Requirements



## Dealer License - Republic of Singapore

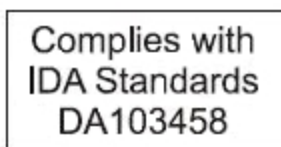

Republic of Singapore - LXE Dealer License Number DA103458 complies with IDA Standards.

## Laser Light Safety Statement



**Warning:** This product uses laser light. One of the following labels is provided on the scanner. Please read the Caution statement. (US)

Mise en garde: Ce produit utilise un rayon laser. L'une des étiquettes suivantes est apposée sur le scanner. Veuillez lire l'avertissement qu'elle contient. (FR)

Advertência: Este produto usa luz de laser. O scanner contém um dos seguintes avisos. Favor ler o Aviso. (PT)

Varning: Denna produkt använder laserljus. En av de nedanstående etiketterna sitter på scannern. Var god läs varningstexten. (SE)

Advarsel: Dette produkt anvender laserlys. En af følgende mærkater anvendes på scanneren. Læs venligst sikkerhedsforanstaltningen. (DK)

Varoitus: Tämä tuote käyttää laservaloa. Skannerissa on jokin seuraavista tarroista. Lue Huomio-kohta. (FI)

Warnung: Dieses Produkt verwendet Laserlicht. Eines der folgenden Etiketten befindet sich auf dem Scanner. Bitte lesen Sie den Gefahrenhinweis. (DE)

Attenzione: Questo prodotto utilizza luce laser. Una delle etichette seguenti c'è ubicata sullo scanner. Si raccomanda di leggere con attenzione le avvertenze riportate. (IT)

















Advarsel: Dette utstyret bruker laserlys. En av følgende etiketter er plassert på scanneren. Les advarselen på etiketten. (NO)

Advertencia: Este producto usa luz de láser. Las etiquetas se proveen en la máquina exploradora. Por favor, lea detenidamente la explicación para las precauciones. (ES)

Waarschuwing: Dit product gebruikt laserlicht. Een van de volgende labels is op de scanner aangebracht. Lees a.u.b. de waarschuwing onder Oppassen. (NL)

<p><b>Uyarı:</b> Bu ürün lazer ışığı kullanır. Aşağıdaki etiketlerden bir tanesi tarayıcınıza üstünde sağlanacaktır. Lütfen Dikkat ifadesini okuyun. (TR)</p>	<p><b>Προειδοποίηση:</b> Αυτό το προϊόν χρησιμοποιεί λέιζερ φως. Υπάρχει μία από τις ακόλουθες ετικέτες στο σαρωτή. Παρακαλούμε διαβάστε τη δήλωση με τίτλο Προσοχή. (GR)</p>
<p><b>경고:</b> 본 제품은 레이저 광선을 사용합니다. 다음 라벨 중 하나가 스캐너에 제공됩니다. 주의 사항을 읽어 주십시오. (KR)</p>	<p><b>警告:</b> この製品はレーザー光線を使用します。 次のラベルのうち1つがスキャナーに貼られています。 注意事項をお読みください。 (JP)</p>
<p><b>警告:</b> 本产品使用激光。 下列一个标签将随扫描仪一道提供。 请阅读“当心”一栏的内容。 (CN)</p>	

Legend: Chinese – CN; Danish – DK; Dutch – NL; English – US; Finnish – FI; French – FR; German – DE; Greek – GR; Italian – IT; Japanese – JP; Korean – KR; Norwegian – NO; Portuguese – PT; Republic of China – ROC; Spanish – ES; Swedish – SE; Turkish – TR.

ENGLISH	 <p><b>AVOID EXPOSURE - LASER RADIATION IS EMITTED FROM THIS APERTURE.</b> EN60825-1:1994+A1:2002+A2:2001 IEC60825-1:1993+A1:1997+A2:2001 COMPLIES WITH 21 CFR 1040.10 AND 1040.11</p> <p>LASER LIGHT - DO NOT STARE INTO BEAM CLASS 2 LASER PRODUCT 1.0mW - 630 - 680nm</p>	FRENCH	 <p><b>AVOID EXPOSURE - LASER RADIATION IS EMITTED FROM THIS APERTURE.</b> EN60825-1:1994+A1:2002+A2:2001 IEC60825-1:1993+A1:1997+A2:2001</p> <p>RAYONNEMENT LASER NE PAS REGARDER DANS LE FAISCEAU APPAREIL A RAYONNEMENT LASER DE CLASSE 2 1.0mW - 630 - 680nm</p>
DANISH	 <p><b>AVOID EXPOSURE - LASER RADIATION IS EMITTED FROM THIS APERTURE.</b> EN60825-1:1994+A1:2002+A2:2001 IEC60825-1:1993+A1:1997+A2:2001</p> <p>LASERLYS KIG IKKE IND I LYSSTRÅLEN KLASSE 2 LASERPRODUKT 1.0mW - 630 - 680nm</p>	GERMAN	 <p><b>AVOID EXPOSURE - LASER RADIATION IS EMITTED FROM THIS APERTURE.</b> EN60825-1:1994+A1:2002+A2:2001 IEC60825-1:1993+A1:1997+A2:2001</p> <p>LASERSTRAHLUNG NICHT IN DEN STRAHL BLICKEN LASER KLASSE 2 1.0mW - 630 - 680nm</p>
GREEK	 <p><b>AVOID EXPOSURE - LASER RADIATION IS EMITTED FROM THIS APERTURE.</b> EN60825-1:1994+A1:2002+A2:2001 IEC60825-1:1993+A1:1997+A2:2001</p> <p>ΠΗΓΗ ΦΩΤΟΣ LASER ΜΗΝ ΚΟΙΤΑΤΕ ΤΗΝ ΔΕΣΜΗ ΠΡΟΪΟΝ LASER ΚΛΑΣΗΣ 2 1.0mW - 630 - 680nm</p>	ITALIAN	 <p><b>AVOID EXPOSURE - LASER RADIATION IS EMITTED FROM THIS APERTURE.</b> EN60825-1:1994+A1:2002+A2:2001 IEC60825-1:1993+A1:1997+A2:2001</p> <p>RADIAZIONE LASER NON FISSARE IL FASCIO APPARECCHIO LASER DI CLASSE 2 1.0mW - 630 - 680nm</p>
NORWEGIAN	 <p><b>AVOID EXPOSURE - LASER RADIATION IS EMITTED FROM THIS APERTURE.</b> EN60825-1:1994+A1:2002+A2:2001 IEC60825-1:1993+A1:1997+A2:2001</p> <p>LASER LYS IKKE SE INN I STRÅLEN KLASSE 2 LASER PRODUKT 1.0mW - 630 - 680nm</p>	SPANISH	 <p><b>AVOID EXPOSURE - LASER RADIATION IS EMITTED FROM THIS APERTURE.</b> EN60825-1:1994+A1:2002+A2:2001 IEC60825-1:1993+A1:1997+A2:2001</p> <p>LUZ DE LÁSER - NO MIRE DIRECTAMENTE AL HAZ DE LUZ PRODUCTO LÁSER DE LA CLASE 2 1.0mW - 630 - 680nm</p>
TURKISH	 <p><b>AVOID EXPOSURE - LASER RADIATION IS EMITTED FROM THIS APERTURE.</b> EN60825-1:1994+A1:2002+A2:2001 IEC60825-1:1993+A1:1997+A2:2001</p> <p>LAZER RÁDYASYON İŞİNA DOĞRU BAKMAYIN CLASS 2 LAZER ÜRÜNÜ 1.0mW - 630 - 680nm</p>	DUTCH	 <p><b>AVOID EXPOSURE - LASER RADIATION IS EMITTED FROM THIS APERTURE.</b> EN60825-1:1994+A1:2002+A2:2001 IEC60825-1:1993+A1:1997+A2:2001</p> <p>LASERBESTRALING NIET IN DE LICHTSTRAAL STAREN KLASS 2 LASER PRODUCT 1.0mW - 630 - 680nm</p>
SIMPLIFIED CHINESE	 <p><b>AVOID EXPOSURE - LASER RADIATION IS EMITTED FROM THIS APERTURE.</b> EN60825-1:1994+A1:2002+A2:2001 IEC60825-1:1993+A1:1997+A2:2001</p> <p>激光辐射 勿直视光束 2类激光产品 1.0mW - 630 - 680nm</p>	PORTUGUESE	 <p><b>AVOID EXPOSURE - LASER RADIATION IS EMITTED FROM THIS APERTURE.</b> EN60825-1:1994+A1:2002+A2:2001 IEC60825-1:1993+A1:1997+A2:2001</p> <p>LUZ DE LASER NÃO OLHE NO RAI0 PRODUTO DE LASER DE CLASSE 2 1.0mW - 630 - 680nm</p>
JAPANESE	 <p><b>AVOID EXPOSURE - LASER RADIATION IS EMITTED FROM THIS APERTURE.</b> EN60825-1:1994+A1:2002+A2:2001 IEC60825-1:1993+A1:1997+A2:2001</p> <p>レーザー光線 - 光源を見つめると危険です クラス2レーザー製品 1.0mW - 630 - 680nm</p>	SWEDISH	 <p><b>AVOID EXPOSURE - LASER RADIATION IS EMITTED FROM THIS APERTURE.</b> EN60825-1:1994+A1:2002+A2:2001 IEC60825-1:1993+A1:1997+A2:2001</p> <p>LASERSTRÅLNING STIRRA EJ IN I STRÅLEN LASERPRODUKT KLASS 2 1.0mW - 630 - 680nm</p>
KOREAN	 <p><b>AVOID EXPOSURE - LASER RADIATION IS EMITTED FROM THIS APERTURE.</b> EN60825-1:1994+A1:2002+A2:2001 IEC60825-1:1993+A1:1997+A2:2001</p> <p>레이저 라이트 - 빛을 바로 쳐다보지 마십시오 2종 레이저 상품 1.0mW - 630 - 680nm</p>	FINNISH	 <p><b>AVOID EXPOSURE - LASER RADIATION IS EMITTED FROM THIS APERTURE.</b> EN60825-1:1994+A1:2002+A2:2001 IEC60825-1:1993+A1:1997+A2:2001</p> <p>VAARA LASERSÄTEILYÄ ÄLÄ TUUJOTA SÄTEESEEN LUOKAN 2 LASER 1.0mW - 630 - 680nm</p>

---

## Lithium Battery Safety Statement

Caution: Lithium battery inside. Danger of explosion if battery is incorrectly replaced. Replace only with same or equivalent type recommended by battery manufacturer. (US)

Attention: Contient une pile de lithium. Risque d'explosion dans le cas où la pile ne serait pas correctement remplacée. Remplacer uniquement avec une pile semblable ou équivalente au type de pile recommandé par le fabricant. (FR)

Forsigtig: Indeholder lithiumbatterier. Risiko for eksplosion, hvis batteriet udskiftes forkert. Må kun udskiftes med samme eller tilsvarende type, som anbefalet af fabrikanten. (DK)

Varoitus: Tämä tuote käyttää laservaloa. Skannerissa on jokin seuraavista tarroista. Lue Huomio-kohta. (FI)

Vorsicht: Enthält Lithium-Batterie. Bei unsachgemäßem Ersatz besteht Explosionsgefahr. Nur durch gleichen oder vom Hersteller empfohlenen Typ ersetzen. (DE)

Attenzione: Batteria al litio. Pericolo di esplosione qualora la batteria venga sostituita in maniera scorretta. Sostituire solo con lo stesso tipo o equivalente consigliato per il fabbricante. (IT)

Atenção: Contém pilha de lítio. Há perigo de explosão no caso de uma substituição incorreta. Substitua somente pelo mesmo tipo, ou equivalente, recomendado pelo fabricante. (PT)

Varning: Innehåller litiumbatteri. Fara för explosion om batteriet är felaktigt placerat eller av fel typ. Använd endast samma eller motsvarande typ batterier rekommenderade av tillverkaren. (SE)

Advarsel: Innmontert Lithium batteri. Eksplosjonsfare ved feil montering av batteri. Benytt kun batteri anbefalt av produsent. (NO)

Cuidado: Pila de litio adentro. Peligro de explosión si la pila se reemplaza incorrectamente. Reemplace solamente con el mismo tipo o equivalente recomendado por el fabricante. (ES)

Oppassen: Bevat Lithium-batterij. Incorrecte plaatsing van batterij kan leiden tot explosiegevaar. Alleen vervangen door hetzelfde of door fabrikant aanbevolen gelijkwaardig type. (NL)

<p><b>Προσοχή:</b> Υπάρχει μπαταρία από λίθιο εσωτερικά. Υπάρχει κίνδυνος έκρηξης εάν η μπαταρία αντικατασταθεί με λανθασμένο τρόπο. Αντικαταστήστε μόνο με τον ίδιο ή ισοδύναμο τύπο που συνιστάται από τον κατασκευαστή. (GR)</p>	<p><b>주의:</b> 리튬 배터리 내부. 배터리가 잘못 설치되었을 경우 폭발의 위험이 있습니다. 동일한 배터리, 또는 배터리 제조업체가 권장하는 배터리로 교체하십시오. (KR)</p>
<p><b>注意:</b> リチウム電池が入っています。間違った種類の電池を使用すると、破裂する恐れがあります。同じ電池、または電池製造元が推奨する同等の電池を使用してください。 (JP)</p>	<p><b>小心:</b> 内装锂电池。如电池更换不当，则有发生爆炸的危险。只能用电池制造商推荐的相同或同等电池进行更换。 (CN)</p>
<p><b>Dikkat:</b> İçinde lityum bataryası bulunur. Bataryanın yanlış değiştirilmesi patlama tehlikesi yaratır. Aynısıyla veya üreticinin önerdiği eşdeğer tiple değiştirin. (TR)</p>	

Legend: Chinese – CN; Danish – DK; Dutch – NL; English – US; Finnish – FI; French – FR; German – DE; Greek – GR; Italian – IT; Japanese – JP; Korean – KR; Norwegian – NO; Portuguese – PT; Spanish – ES; Swedish – SE; Turkish – TR.



---

## Vehicle Power Supply Connection Safety Statement

Vehicle Power Supply Connection: If the supply connection is made directly to the battery, a 5A slow-blow fuse should be installed in the positive lead within 5 inches (12.7 cm.) of the battery positive (+) terminal. (US)

Raccordement de l'alimentation du véhicule Si l'alimentation est raccordée directement à la batterie, un fusible à action retardée de 5 A doit être installé sur le câble positif à moins de 12,7 cm de la borne positive (+) de la batterie. (FR)

EL forsyning af køretøjet. Er forsyningsforbindelsen direkte tilknyttet til batteriet og og tilsluttet til den positive part indenfor 12,7 cm (+ delen). vil der være en langsom tændelse af 5 ampere. (DK)

Kytkentä ajoneuvon virtalähteeseen Jos virtaa otetaan suoraan akusta, 5 ampeerin hidas sulake on asennettava positiiviseen johtoon enintään 12 cm:n etäisyydelle akun positiivisesta (+) navasta. (FI)

Anschluss an Fahrzeugbatterie Bei direktem Anschluss an die Fahrzeugbatterie sollte eine träge 5 A-Sicherung in die positive Leitung zwischengeschaltet werden, und zwar nicht weiter als ca. 13 cm von der positiven (+) Batterieklemme entfernt. (DE)

Σύνδεση Τροφοδοτικού Ισχύος Οχήματος Αν η σύνδεση του τροφοδοτικού γίνει κατευθείαν στη μπαταρία, μια ασφάλεια βραδείας τήξης των 5 Α θα πρέπει να τοποθετηθεί στο θετικό καλώδιο εντός 5 ιντσών (12,7 εκ.) του θετικού (+) ακροδέκτη της μπαταρίας. (GR)

Collegamento dell'alimentazione del veicolo Se il collegamento dell'alimentazione viene stabilito direttamente con la batteria, è necessario installare un fusibile ad azione lenta da 5 A nel conduttore positivo a meno di 5 in. (12,7 cm) dal terminale positivo (+) della batteria. (IT)

Tilkople strømforsyningen til kjøretøyet Hvis strømforsyningen koples direkte til batteriet, skal det installeres en 5 A treg sikring i den positive ledningen innen 12,7 cm fra plusspolen (+) på batteriet. (NO)

Ligação do fornecimento de corrente do veículo Se a ligação de fornecimento de corrente for ligada directamente à bateria, deve instalar-se um fusível de 5 A no terminal positivo, a 12,7 cm. do terminal positivo (+) da bateria. (PT)

Conexión de suministro eléctrico para el vehículo Si el suministro eléctrico se proporciona directamente a la batería, se debe instalar un fusible de retardo de 5 A en el conductor positivo, como máximo a 12,7 cm (5 pulgadas) del terminal positivo (+). (ES)

Fordonets strömförsörjningskoppling Om strömkopplingen görs direkt till batteriet, måste en 5 A-säkring installeras i den positivt laddade ledningen inom 12.7 cm från batteriets pluspol (+). (SE)

Taşıt Güç Kaynağı Bağlantısı Kaynak bağlantısı doğrudan aküye yapılırsa, pozitif bağlantı kablosu üzerinde akünün pozitif (+) kutbuna 12.7 cm mesafede 5 A'lık yavaş atan bir sigorta monte edilmelidir. (TR)

Legend: Danish – DK; English – US; Finnish – FI; French – FR; German – DE; Greek – GR; Italian – IT; Norwegian – NO; Portuguese – PT; Spanish – ES; Swedish – SE; Turkish – TR.



# Chapter 5: Technical Assistance

If you need assistance installing or troubleshooting your device, please contact us by using one of the methods below:

**Knowledge Base:** [www.hsmknowledgebase.com](http://www.hsmknowledgebase.com)

Our Knowledge Base provides thousands of immediate solutions. If the Knowledge Base cannot help, our Technical Support Portal (see below) provides an easy way to report your problem or ask your question.

**Technical Support Portal:** [www.hsmsupportportal.com](http://www.hsmsupportportal.com)

The Technical Support Portal not only allows you to report your problem, but it also provides immediate solutions to your technical issues by searching our Knowledge Base. With the Portal, you can submit and track your questions online and send and receive attachments.

**Web form:** [www.hsmcontactsupport.com](http://www.hsmcontactsupport.com)

You can contact our technical support team directly by filling out our online support form. Enter your contact details and the description of the question/problem.

**Telephone:** [www.honeywellaidc.com/locations](http://www.honeywellaidc.com/locations)

For our latest contact information, please check our website at the link above.

## Product Service and Repair

Honeywell International Inc. provides service for all of its products through service centers throughout the world. To obtain warranty or non-warranty service, please visit [www.honeywellaidc.com](http://www.honeywellaidc.com) and select **Support > Contact Service and Repair** to see your region's instructions on how to obtain a Return Material Authorization number (RMA #). You should do this prior to returning the product.

## Limited Warranty

Honeywell International Inc. ("HII") warrants its products to be free from defects in materials and workmanship and to conform to HII's published specifications applicable to the products purchased at the time of shipment. This warranty does not cover any HII product which is (i) improperly installed or used; (ii) damaged by accident or negligence, including failure to follow the proper maintenance, service, and cleaning schedule; or (iii) damaged as a result of (A) modification or alteration by the purchaser or other party, (B) excessive voltage or current supplied to or drawn from the interface connections, (C) static electricity or electro-static discharge, (D) operation under conditions beyond the specified operating parameters, or (E) repair or service of the product by anyone other than HII or its authorized representatives.

This warranty shall extend from the time of shipment for the duration published by HII for the product at the time of purchase ("Warranty Period"). Any defective product must be returned (at purchaser's expense) during the Warranty Period to HII factory or authorized service center for inspection. No product will be accepted by HII without a Return Materials Authorization, which may be obtained by contacting HII. In the event that the product is returned to HII or its authorized service center within the Warranty Period and HII determines to its satisfaction that the product is defective due to defects in materials or workmanship, HII, at its sole option, will either repair or replace the product without charge, except for return shipping to HII.

EXCEPT AS MAY BE OTHERWISE PROVIDED BY APPLICABLE LAW, THE FOREGOING WARRANTY IS IN LIEU OF ALL OTHER COVENANTS OR WARRANTIES, EITHER EXPRESSED OR IMPLIED, ORAL OR WRITTEN, INCLUDING, WITHOUT LIMITATION, ANY IMPLIED WARRANTIES OF MERCHANTABILITY OR FITNESS FOR A PARTICULAR PURPOSE, OR NON-INFRINGEMENT.

HII'S RESPONSIBILITY AND PURCHASER'S EXCLUSIVE REMEDY UNDER THIS WARRANTY IS LIMITED TO THE REPAIR OR REPLACEMENT OF THE DEFECTIVE PRODUCT WITH NEW OR REFURBISHED PARTS. IN NO EVENT

---

SHALL HII BE LIABLE FOR INDIRECT, INCIDENTAL, OR CONSEQUENTIAL DAMAGES, AND, IN NO EVENT, SHALL ANY LIABILITY OF HII ARISING IN CONNECTION WITH ANY PRODUCT SOLD HEREUNDER (WHETHER SUCH LIABILITY ARISES FROM A CLAIM BASED ON CONTRACT, WARRANTY, TORT, OR OTHERWISE) EXCEED THE ACTUAL AMOUNT PAID TO HII FOR THE PRODUCT. THESE LIMITATIONS ON LIABILITY SHALL REMAIN IN FULL FORCE AND EFFECT EVEN WHEN HII MAY HAVE BEEN ADVISED OF THE POSSIBILITY OF SUCH INJURIES, LOSSES, OR DAMAGES. SOME STATES, PROVINCES, OR COUNTRIES DO NOT ALLOW THE EXCLUSION OR LIMITATIONS OF INCIDENTAL OR CONSEQUENTIAL DAMAGES, SO THE ABOVE LIMITATION OR EXCLUSION MAY NOT APPLY TO YOU.

All provisions of this Limited Warranty are separate and severable, which means that if any provision is held invalid and unenforceable, such determination shall not affect the validity of enforceability of the other provisions hereof. Use of any peripherals not provided by the manufacturer may result in damage not covered by this warranty. This includes but is not limited to: cables, power supplies, cradles, and docking stations. HII extends these warranties only to the first end-users of the products. These warranties are non-transferable.

The duration of the limited warranty for the MX3Plus is 1 year.

The duration of the limited warranty for the MX3Plus Desktop Cradle is 1 year.

The duration of the limited warranty for the MX3Plus Vehicle Cradle is 1 year.

The duration of the limited warranty for the MX3Plus Battery Charger is 1 year.

The duration of the limited warranty for the MX3Plus 1900 Ah Li-Ion Battery is 6 months.

The duration of the limited warranty for the MX3Plus AC power supply and cables is 1 year.

The duration of the limited warranty for the MX3Plus DC-DC Converter and cable is 1 year.

The duration of the limited warranty for the MX3Plus cables (USB, Serial, Communication, Power) is 1 year.



Honeywell Scanning & Mobility  
9680 Old Bailes Road  
Fort Mill, SC 29707  
[www.honeywellaidc.com](http://www.honeywellaidc.com)

E-EQ-MX3PLUSOGWW  
Rev P  
10/12

## Free Manuals Download Website

<http://myh66.com>

<http://usermanuals.us>

<http://www.somanuals.com>

<http://www.4manuals.cc>

<http://www.manual-lib.com>

<http://www.404manual.com>

<http://www.luxmanual.com>

<http://aubethermostatmanual.com>

Golf course search by state

<http://golfingnear.com>

Email search by domain

<http://emailbydomain.com>

Auto manuals search

<http://auto.somanuals.com>

TV manuals search

<http://tv.somanuals.com>