

ST 3000 Smart Transmitter Series 900 Remote Diaphragm Seals Models

STR93D	0 to 100 psid	0 to 7 bar
STR94G	0 to 500 psig	0 to 35 bar

Specification and Model Selection Guide

Introduction

In 1983, Honeywell introduced the first Smart Pressure Transmitter—the ST 3000®. In 1989, Honeywell launched the first all digital, bi-directional protocol for smart field devices. Today, its ST 3000 Series 900 Remote Seal Transmitters continue to bring proven “smart” technology to a wide spectrum of pressure measurement applications. For applications in which the transmitter must be mounted remotely from the process, Honeywell offers the remote seal line of gauge, absolute and differential pressure transmitters. Typical applications include level measurement in pressurized vessels in the chemical and hydrocarbon processing industries. A second application is flow measurement for slurries and high viscosity fluids in the chemical industry. Honeywell remote seal transmitters are available with secondary fill fluids for corrosive or high temperature process fluids

All ST 3000 transmitters can provide a 4-20 mA output, Honeywell Digitally Enhanced (DE) output, HART® output, or FOUNDATION™ Fieldbus output. When digitally integrated with Honeywell’s Process Knowledge System™, EXPERION PKS™, ST 3000 instruments provide a more accurate process variable as well as advanced diagnostics.

Honeywell’s cost-effective ST 3000 S900 transmitters lead the industry in reliability and stability:

- Stability = ±0.01% per year
- Reliability = 470 years MTBF



Figure 1—Series 900 Remote Seal Pressure Transmitters feature proven piezoresistive sensors and advanced seal technology with standard weld connections.

The devices provide comprehensive self-diagnostics to help users maintain high uptime, meet regulatory requirements, and attain high quality standards. S900 transmitters allow smart performance at analog prices. Accurate, reliable and stable, Series 900 transmitters offer greater turndown ratio than conventional transmitters.

“Honeywell transmitters operating in the digital mode using Honeywell’s Digitally Enhanced (DE) protocol make diagnostics available right at the control system’s human interface. Equally important, transmitter status information is continuously displayed to alert the operator immediately of a fault condition. Because the process variable (PV) status transmission precedes the PV value, we are guaranteed that a bad PV is not used in a control algorithm. In addition, bi-directional communication provides for remote transmitter configuration directly from the human interface, enabling management of the complete loop.”

Maureen Atchison, DuPont
Site Electrical & Instrumentation Leader

Description of Diaphragm Seals

Diaphragm seals are traditionally used when a standard pressure transmitter should not be exposed to the process pressure directly. Diaphragm seals typically protect the pressure transmitter from one or more damaging aspects of the process media. Consideration for using a diaphragm seal should be made in the following circumstances.

- High Process Temperature
- Process Media is Viscous or Contains Suspended Solids
- Process Media is Subject to Solidifying
- Process Media is Corrosive
- Process Application Requires Sanitary Connections
- Process Application Subjects the Measuring Instrument to Hydrogen Permeation
- Tank Level Applications with Maintenance Intensive Wet Legs
- Tank Application with Density or Interface Measurements
- Measuring Instrument Requires Remote Mounting

The following diaphragm seals are standard from Honeywell (please call your local salesperson if you do not see the product you need for your application):

Figure 2 - Flush Flange Seals can be used with differential, gauge and absolute pressure transmitters and are available with 3" ANSI Class 150, ANSI Class 300 and DIN DN80-PN40 process connections. Flush flange seals can also be provided with Lowers. Lowers are essentially calibration rings, which allow flushing connections if needed – see Figure 31.



Figure 2

Figure 3 - Flange Seal with Extended Diaphragm can be used with differential, gauge and absolute pressure transmitters and are available with 3" and 4" ANSI Class 150, ANSI Class 300, DIN DN80-PN40 and DIN DN100-PN40 process connections. 2", 4" and 6" extension lengths are available.



Figure 3

Figure 4 - Pancake Seals can be used with differential, gauge and absolute pressure transmitters and are available with 3" ANSI Class 150, 300 and 600 process connections.



Figure 4

Figure 5 - Chemical Tee "Taylor" Wedge seals can be used with differential pressure transmitters and are available with Taylor Wedge 5" O.D. process connection.



Figure 5







Description of Diaphragm Seals	
<p>Figure 6 - Seals with Threaded Process Connections can be used with differential, gauge and absolute pressure transmitters and are available with 1/2", 3/4" and 1" NPT Female process connections.</p>	 <p style="text-align: center;">Figure 6</p>
<p>Figure 7 - Sanitary Seals can be used with differential, gauge and absolute pressure transmitters and are available with 3" and 4" Tri-Clover-Tri-Clamp process connections.</p>	 <p style="text-align: center;">Figure 7</p>
<p>Figure 8 - Saddle Seals can be used with differential, gauge and absolute pressure transmitters and are available with 3" and 4" (6 bolt or 8 bolt designs) process connections.</p>	 <p style="text-align: center;">Figure 8</p>
<p>Figure 9 - Calibration Rings are available with Flush Flange Seals and Pancake Seals. Flushing ports (1/4" or 1/2") are available with calibration rings.</p>	 <p style="text-align: center;">Figure 9</p>
<p>Figure 10 - Stainless Steel Armor and PVC Coated Stainless Steel Armor Capillaries are available with Honeywell Remote Seal Solutions.</p>	 <p style="text-align: center;">Figure 10</p>
<p>Figure 11 - 2" Stainless Steel Nipples are available for Close-Coupled remote seal solutions.</p>	 <p style="text-align: center;">Figure 11</p>

Figure 12 - Welded Meter Body for All-Welded Remote Seal Solution. The welded ST 3000 meter body is an important part of an All-Welded Remote Seal Solution, which is commonly used in Vacuum applications.



Figure 12

Description

The ST 3000 transmitter can replace any 4 to 20 mA output transmitter in use today and operates over a standard two-wire system.

The measuring means is a piezoresistive sensor, which actually contains three sensors in one. It contains a differential pressure sensor, a temperature sensor, and a static pressure sensor.

Microprocessor-based electronics provide higher span-turndown ratio, improved temperature and pressure compensation, and improved accuracy.

The transmitter's meter body and electronics housing resist shock, vibration, corrosion, and moisture. The electronics housing contains a compartment for the single-board electronics, which is isolated from an integral junction box. The single-board electronics is replaceable and interchangeable with any other ST 3000 Series 100 or Series 900 model transmitter.

Like other Honeywell transmitters, the ST 3000 features two-way communication and configuration capability between the operator and the transmitter through several Honeywell field-rated portable configuration devices, including the Smart Field Communicator (SFC) and the Multiple Communication Configurator (MC ToolKit). While both are made for in-field use, the MC Toolkit also can be ordered for use in intrinsically safe environments.

The SCT 3000 Smartline® Configuration Toolkit provides an easy way to configure instruments using a personal computer. The toolkit enables configuration of devices before shipping or installation. The SCT 3000 can operate in the offline mode to configure an unlimited number of devices. The database can then be loaded down-line during commissioning.

Features

- Choice of linear or square root output conformity is a simple configuration selection.
- Direct digital integration with Experion PKS and other control systems provides local measurement accuracy to the system level without adding typical A/D and D/A converter inaccuracies.
- Unique piezoresistive sensor automatically compensates input for temperature and static pressure. Added "smart" features include configuring lower and upper range values, simulating accurate analog output, and selecting preprogrammed engineering units for display.
- Smart transmitter capabilities with local or remote interfacing means significant manpower efficiency improvements in commissioning, start-up, and ongoing maintenance functions.

Specifications

Operating Conditions – All Models

Parameter	Reference Condition (at zero static)		Rated Condition		Operative Limits		Transportation and Storage	
	°C	°F	°C	°F	°C	°F	°C	°F
Ambient Temperature	25 ±1	77 ±2	-25 to 70	-13 to 158	-40 to 85	-40 to 185	-55 to 125	-67 to 257
Process Interface Temperature	25 ±1	77 ±2	See Figure 13				-55 to 125	-67 to 257
Humidity %RH	10 to 55		0 to 100		0 to 100		0 to 100	
Maximum Allowable Working Pressure (MAWP)	MAWP is minimum of Body Rating or Seal Rating (See Model Selection Guide for Seal MAWP)							
			Body	MAWP				
			STR93D	750 psig (52 bar)				
			STR94G	500 psig (35 bar)				
Vacuum Region, Minimum Pressure - mmHg absolute inH₂O absolute	atmospheric atmospheric		See Figure 13					
Supply Voltage, Current, and Load Resistance	Voltage Range: 10.8 to 42.4 Vdc at terminals Current Range: 3.0 to 21.8 mA Load Resistance: 0 to 1440 ohms (as shown in Figure 14)							

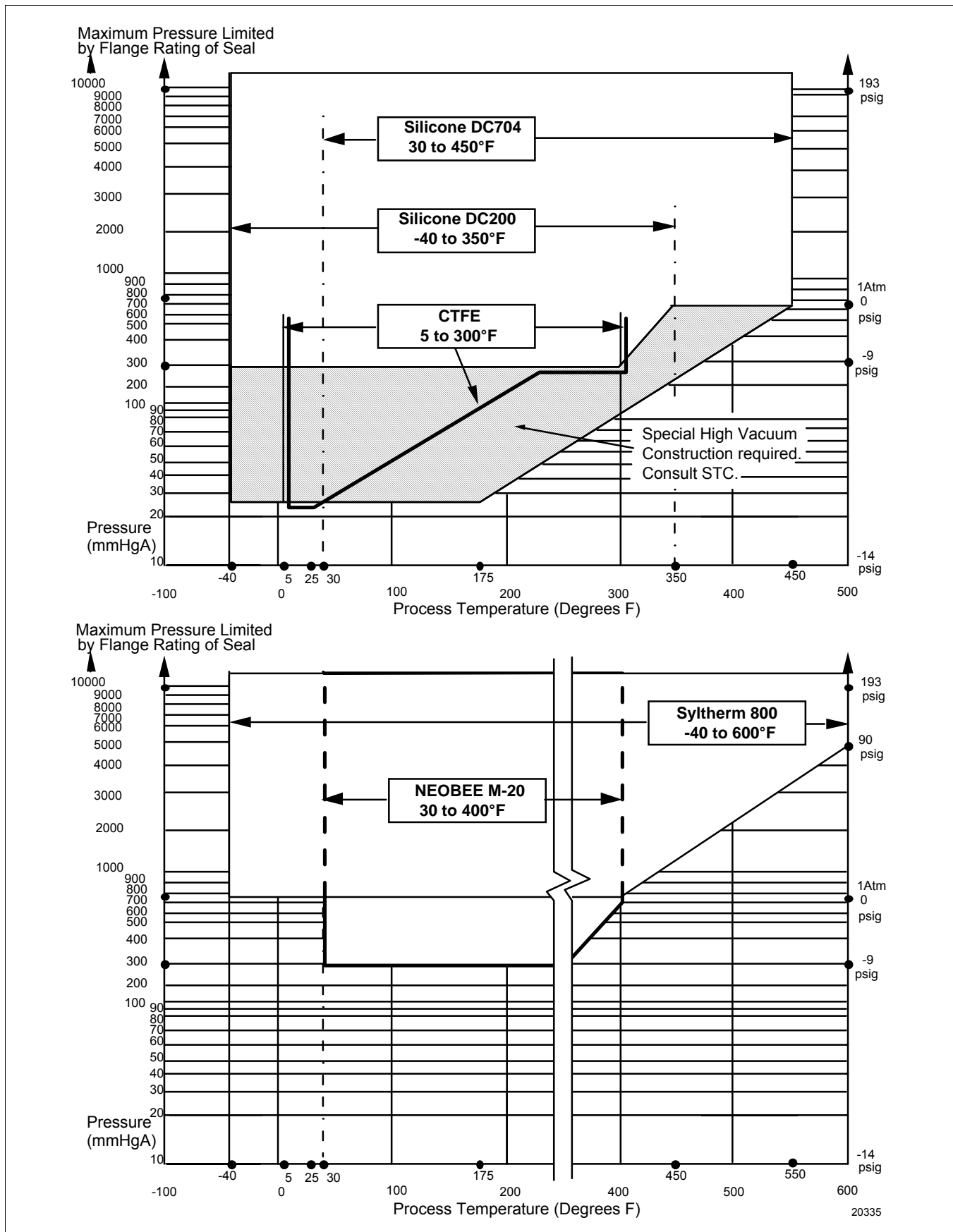

Figure 13—ST 3000 Remote Seals operable limits for pressure versus temperature

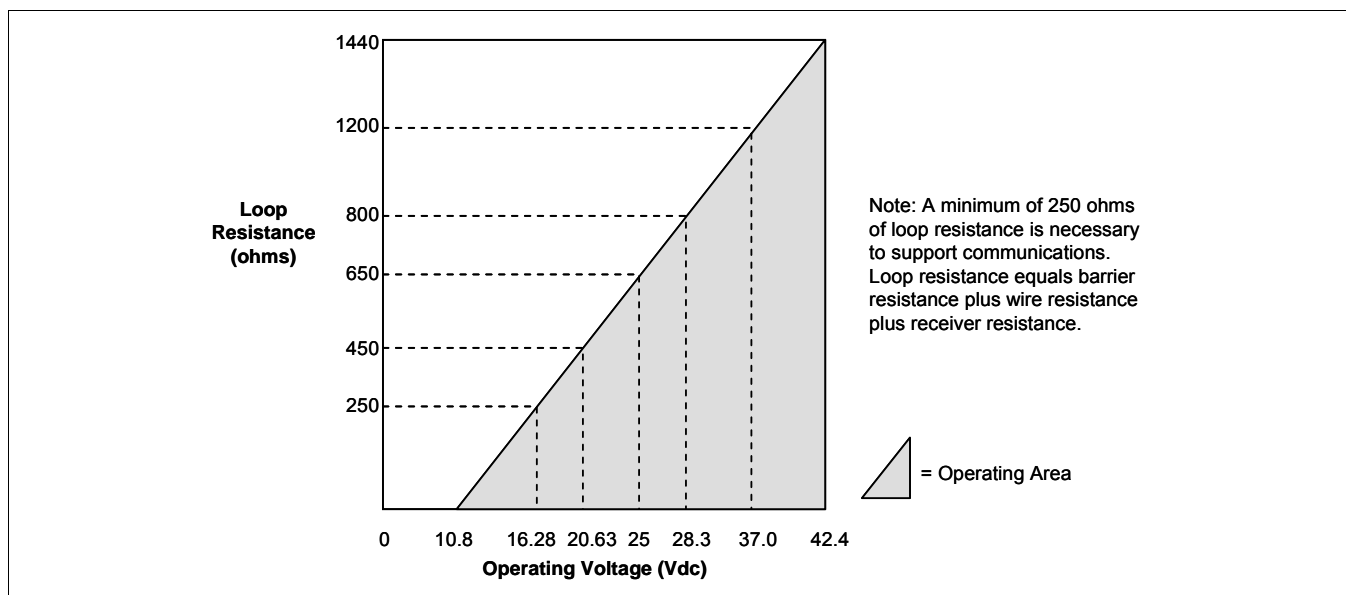

Figure 14—Supply voltage and loop resistance chart

Performance Under Rated Conditions * - Model STR93D (0 to 100 psi/7 bar)

Parameter	Description
Upper Range Limit psi bar	100 (Transmitter URL or maximum seal pressure rating, whichever is lower.) 7
Minimum Span psi bar	0.9 0.063
Turndown Ratio	110 to 1
Zero Elevation and Suppression	No limit except minimum span within ±100% URL.
Accuracy (Reference – Includes combined effects of linearity, hysteresis, and repeatability) • Accuracy includes residual error after averaging successive readings. • For FOUNDATION Fieldbus use Digital Mode specifications. For HART use Analog Mode specifications.	In Analog Mode: ±0.20% of calibrated span or upper range value (URV), whichever is greater, terminal based. For URV below reference point (50 inH ₂ O), accuracy equals: $\pm 0.10 + 0.10 \left(\frac{50 \text{ inH}_2\text{O}}{\text{span inH}_2\text{O}} \right) \text{ or } \pm 0.10 + 0.10 \left(\frac{125 \text{ mbar}}{\text{span mbar}} \right) \text{ in \% of span}$ In Digital Mode: ±0.175% of calibrated span or upper range value (URV), whichever is greater, terminal based. For URV below reference point (50 inH ₂ O), accuracy equals: $\pm 0.075 + 0.10 \left(\frac{50 \text{ inH}_2\text{O}}{\text{span inH}_2\text{O}} \right) \text{ or } \pm 0.075 + 0.10 \left(\frac{125 \text{ mbar}}{\text{span mbar}} \right) \text{ in \% of span}$
Combined Zero and Span Temperature Effect per 28°C (50°F) **	In Analog Mode: ±1.5% of span. For URV below reference point (200 inH ₂ O), effect equals: $\pm 0.30 + 1.2 \left(\frac{200 \text{ in H}_2\text{O}}{\text{span in H}_2\text{O}} \right) \text{ or } \pm 0.30 + 1.2 \left(\frac{500 \text{ mbar}}{\text{span mbar}} \right) \text{ in \% span}$ In Digital Mode: ±1.475% of span. For URV below reference point (200 inH ₂ O), effect equals: $\pm 0.275 + 1.2 \left(\frac{200 \text{ in H}_2\text{O}}{\text{span in H}_2\text{O}} \right) \text{ or } \pm 0.275 + 1.2 \left(\frac{500 \text{ mbar}}{\text{span mbar}} \right) \text{ in \% span}$

* Performance specifications are based on reference conditions of 25°C (77°F), zero (0) static pressure, 10 to 55% RH, and 316L Stainless Steel barrier diaphragm.

** Specification applies to transmitters with 2 seals only. Apply 1.5 times factor to temperature effect for capillary lengths greater than 10 feet or for 2-inch sanitary seals.

Performance Under Rated Conditions * - Models STR94G (0 to 500 psi/35 bar)

Parameter	Description
Upper Range Limit psi bar	500 35
Minimum Span psi bar	20 1.4
Turndown Ratio	25 to 1
Zero Elevation and Suppression	No limit except minimum span from absolute 0 (zero) to +100% URL.
Accuracy (Reference – Includes combined effects of linearity, hysteresis, and repeatability) <ul style="list-style-type: none"> Accuracy includes residual error after averaging successive readings. For FOUNDATION Fieldbus use Digital Mode specifications. For HART use Analog Mode specifications. 	<p>In Analog Mode: ±0.10% of calibrated span or upper range value (URV), whichever is greater, terminal based.</p> <p>In Digital Mode: ±0.075% of calibrated span or upper range value (URV), whichever is greater, terminal based.</p>

* Performance specifications are based on reference conditions of 25°C (77°F), zero (0) static pressure, 10 to 55% RH, and 316L Stainless Steel barrier diaphragm.

Transmitter Minimum Span and Maximum Capillary Length

Minimum recommended span for STR93D DP Transmitter with two Remote Seals

Diaphragm Size	Capillary							Capillary Length maximum
	5'	10'	15'	20'	25'	30'	35'	
2.0	15 psig	20 psig	25 psig	-	-	-	-	15'
2.4	150 iwc	200 iwc	250 iwc	300 iwc	350 iwc	400 iwc	450 iwc	35'
2.9	50 iwc	75 iwc	100 iwc	125 iwc	150 iwc	175 iwc	200 iwc	35'
3.5	25 iwc	25 iwc	25 iwc	25 iwc	28 iwc	32 iwc	40 iwc	35'
4.1	25 iwc	25 iwc	25 iwc	25 iwc	25 iwc	27 iwc	30 iwc	35'

Minimum recommended span for STR94G or STR93D DP Transmitter with one Remote Seal

Diaphragm Size	Direct Mount	Capillary						Capillary Length maximum
		5'	10'	15'	20'	30'	35'	
2.0	25 psi	30 psi	40 psi	50 psi	-	-	-	15'
2.4	10 psi	15 psi	20 psi	25 psi	30 psi	40 psi	50 psi	35'
2.9	8 psi	9 psi	10 psi	11 psi	12 psi	14 psi	15 psi	35'
3.5	2 psi	2 psi	3 psi	4 psi	5 psi	7 psi	8 psi	35'
4.1	0.9 psi	0.9 psi	1 psi	2 psi	3 psi	4 psi	5 psi	35'

Minimum span is the higher of the value from the table above or the value defined under Performance Conditions for the range transmitter

Figure 15— Maximum capillary length and diaphragm size chart.

Performance Under Rated Conditions - General for all Models

Parameter	Description
Output (two-wire)	Analog 4 to 20 mA or DE digital communications mode. Options available for FOUNDATION Fieldbus and HART protocols.
Supply Voltage Effect	0.005% of span per volt.
Damping Time Constant	Adjustable from 0 to 32 seconds digital damping.
CE Conformity (Europe)	89/336/EEC, Electromagnetic Compatibility (EMC) Directive.
NAMUR NE 43 Compliance Option	Transmitter failure information is generated when the measuring information is invalid or no longer present. Failure information is transmitted as a current signal but outside the normal 4-20 mA measurement signal level. Transmitter failure values are: ≤ 3.6 mA and ≥ 21.0 mA. The normal signal range is ≥ 3.8 mA and ≤ 20.5 mA.
SIL 2/3 Compliance	SIL certified to IEC 61508 for non-redundant use in SIL 2 related Safety Systems (single use) and for redundant (multiple) use in SIL 3 Safety Systems through TÜV Nord Sys Tec GmbH & Co. KG under the following standards: IEC61508-1: 1998; IEC 61508-2: 2000; IEC61508-3: 1998.

Physical and Approval Bodies

Parameter	Description
Process Interface	See Model Selection Guide for Material Options for desired Seal Type.
Seal Barrier Diaphragm	316L Stainless Steel, Monel, Hastelloy C, Tantalum
Seal Gasket Materials	Klinger C-4401 (non-asbestos) Grafoil Teflon Gylon 3510
Mounting Bracket	Carbon Steel (zinc-plated) or Stainless Steel angle bracket or Carbon Steel flat bracket available.
Fill Fluid (Meter Body)	Silicone (DC 200) S.G. @ 25°C (77°F) = 0.94 CTFE (Chlorotrifluoroethylene) S.G. @ 25°C (77°F) = 1.89
Fill Fluid (Secondary)*	Silicone (DC 200) S.G. @ 25°C (77°F) = 0.94 CTFE (Chlorotrifluoroethylene) S.G. @ 25°C (77°F) = 1.89 Silicone (DC 704) S.G. @ 25°C (77°F) = 1.07 Syltherm 800 S.G. @ 25°C (77°F) = 0.90 NEOBEE M-20 S.G. @ 25°C (77°F) = 0.93
Electronics Housing	Epoxy-Polyester hybrid paint. Low-copper aluminum alloy. Meets NEMA 4X (watertight) and NEMA 7 (explosion proof)
Capillary Tubing**	Armored Stainless Steel or PVC Coated Armored Stainless Steel. Length: 5, 10, 15, 20, 25 and 35 feet (1.5, 3, 4.6, 6.1, 7.5 and 10.7m). A 2" (51 millimeter) S.S. close-coupled nipple is also available. See Model Selection Guide.
Wiring	Accepts up to 16 AWG (1.5 mm diameter)
Mounting	See Figure 16.
Dimensions	See Figures 19 and 20 for transmitter dimensions. See Model Selection Guide for Seal dimensions
Net Weight	Transmitter: 4.1 Kg (9 lbs). Total weight is dependent on seal type and capillary length.
Approval Bodies	<p>Factory Mutual</p> <p>Explosion Proof: Approved as Explosion Proof for Class I, Division 1, Groups A, B, C, D locations, Dust Ignition Proof: Approved as Dust Ignition Proof for Class II, III, Division 1, Groups E, F, G locations, Intrinsically Safe: Approved as Intrinsically Safe for for Class I, II, III, Division 1, Groups A, B, C, D, E, F, G locations. Nonincendive: Approved as Nonincendive for Class I, Division 2, Groups A, B, C, D locations.</p> <p>CSA</p> <p>Explosion Proof: Approved as Explosion Proof for Class I, Division 1, Groups B, C, D locations, Dust Ignition Proof: Approved as Dust Ignition Proof for Class II, III, Division 1, Groups E, F, G locations, Intrinsically Safe: Approved as Intrinsically Safe for Class I, II, III, Division 1, Groups A, B, C, D, E, F, G locations.</p> <p>Canadian Registration Number (CRN)</p> <p>All ST 3000 model designs, except SATG19L, STG99L, STG170 and STG180 have been registered in all provinces and territories in Canada and are marked CRN:0F8914.5c.</p> <p>ATEX</p> <p>Intrinsically Safe, Zone 0/1: EEx ia IIC T4, T5, T6 Flameproof/Zone 1: EEx d IIC T5, T6 (enclosure IP 66/67) Non-Sparking, Zone 2: EEx nA, IIC T6 (enclosure IP 66/67) Multiple Markings: Ex II 1 G: EEx ia IIC T4, T5, T6, <u>Ex II 2 G:</u> EExd IIC T5, T6 <u>Ex II 3 G:</u> EEx nA, IIC T6 (Honeywell) (enclosure IP 66/67)</p> <p>SA (Australian)</p> <p>Intrinsically Safe: EX ia IIC T4 Non-Sparking: Ex n IIC T6 (T4 with SM option)</p> <p>INMETRO (Brazil)</p> <p>Flame-Proof, Zone 1: EX d IIC T5</p>

Parameter	Description
Pressure Equipment Directive (97/23/EC)	The ST 3000 pressure transmitters listed in this Specification have no pressurized internal volume or have a pressurized internal volume rated less than 1,000 bar (14,500 psig) and/or have a maximum volume of less than 0.1 liter. Therefore, these transmitters are either; not subject to the essential requirements of the directive 97/23/EC (PED, Annex 1) and shall not have the CE mark, or the manufacturer has the free choice of a module when the CE mark is required for pressures > 200 bar (2,900 psig).

* See Figure 13 for Fill Fluid temperature limits.

** 2-inch Sanitary Seals are limited to 15 ft. (4.6 m) capillary length.

NOTE: Pressure transmitters that are part of safety equipment for the protection of piping (systems) or vessel(s) from exceeding allowable pressure limits, (equipment with safety functions in accordance with Pressure Equipment Directive 97/23/EC article 1, 2.1.3), require separate examination.

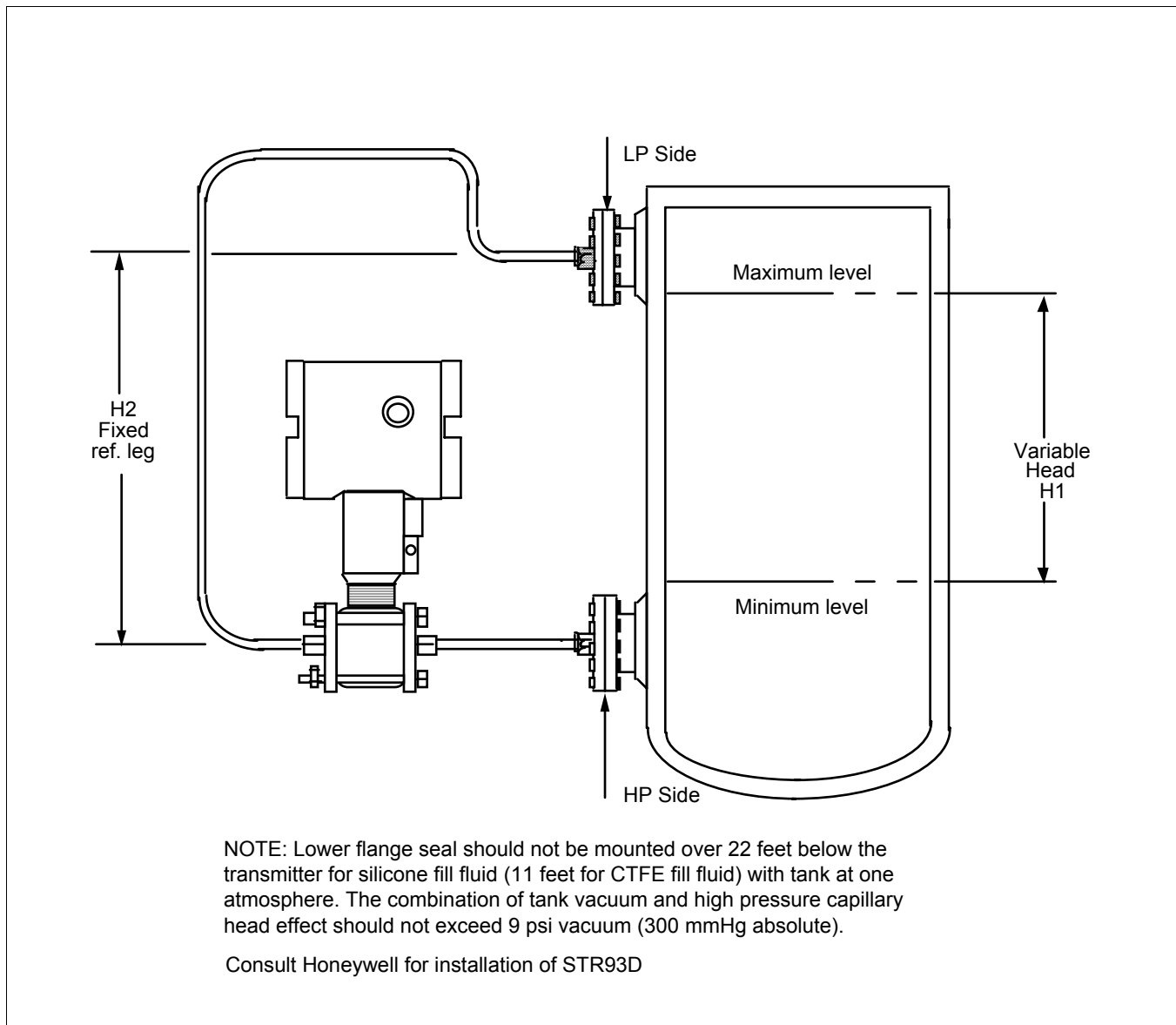

Figure 16—Typical mounting arrangement for ST 3000 Transmitter with Remote Diaphragm Seals

Application Data

Liquid Level: Closed Tank

Determine the minimum and maximum pressure differentials to be measured (Figure 17).

$$P_{Min} = (SG_p \times a) - (SG_f \times d)$$

= LRV when HP at bottom of tank
= -URV when LP at bottom of tank

$$P_{Max} = (SG_p \times b) - (SG_f \times d)$$

= URV when HP at bottom of tank
= -LRV when LP at bottom of tank

Where:

minimum level = 4mA

maximum level = 20 mA

a = distance between bottom tap and minimum level

b = distance between bottom tap and maximum level

d = distance between taps

SG_f = Specific Gravity of capillary fill fluid (See Page 9 for values.)

SG_p = Specific Gravity of process fluid

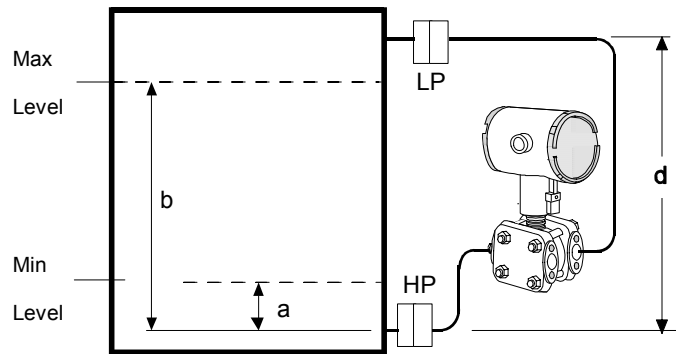

≠ Transmitter above datum

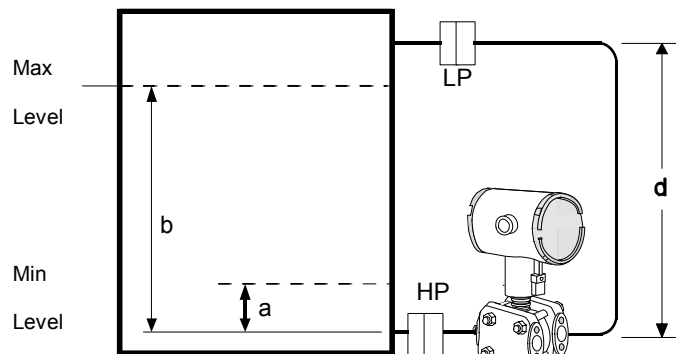

≠ Transmitter at datum

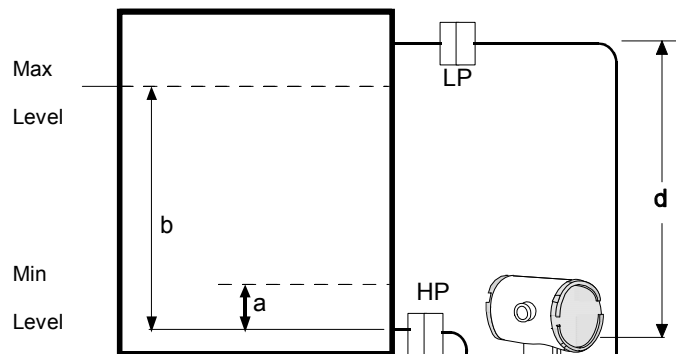

≠ Transmitter below datum

24253

Figure 17—Closed tank liquid level measurement distances

Density or Interface

Calculate the minimum and maximum pressure differentials to be measured (Figure 18).

$P_{\min} = (SG_{\min} - SG_f) \times (d)$;
minimum density, 4mA output

$P_{\max} = (SG_{\max} - SG_f) \times (d)$;
maximum density, 20mA output

Where:

d = distance between the taps

SG_{\max} = maximum Specific Gravity

SG_{\min} = minimum Specific Gravity

SG_f = Specific Gravity of capillary fill fluid (See Page 9 for values.)

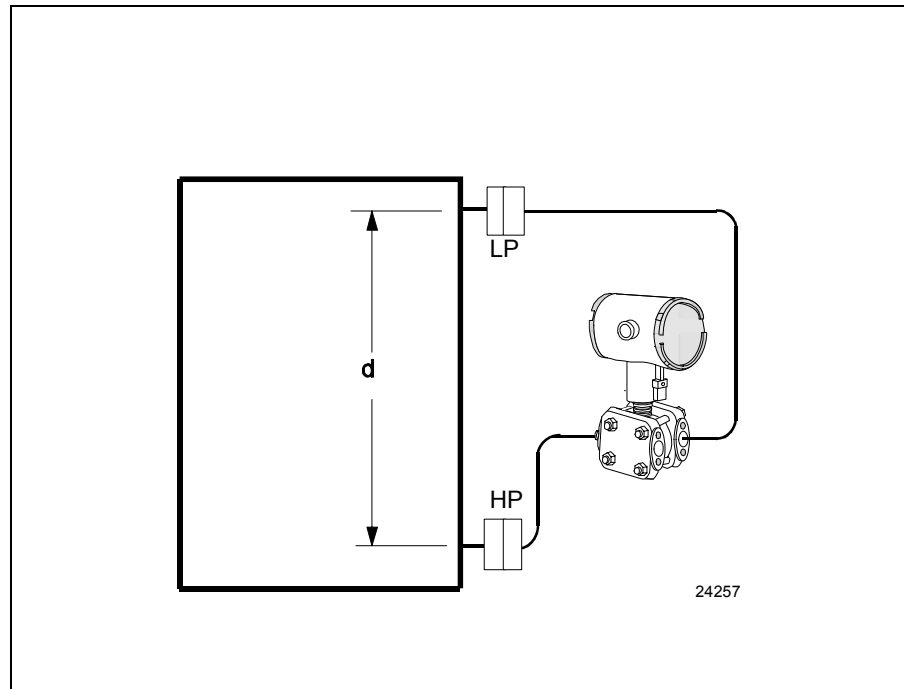
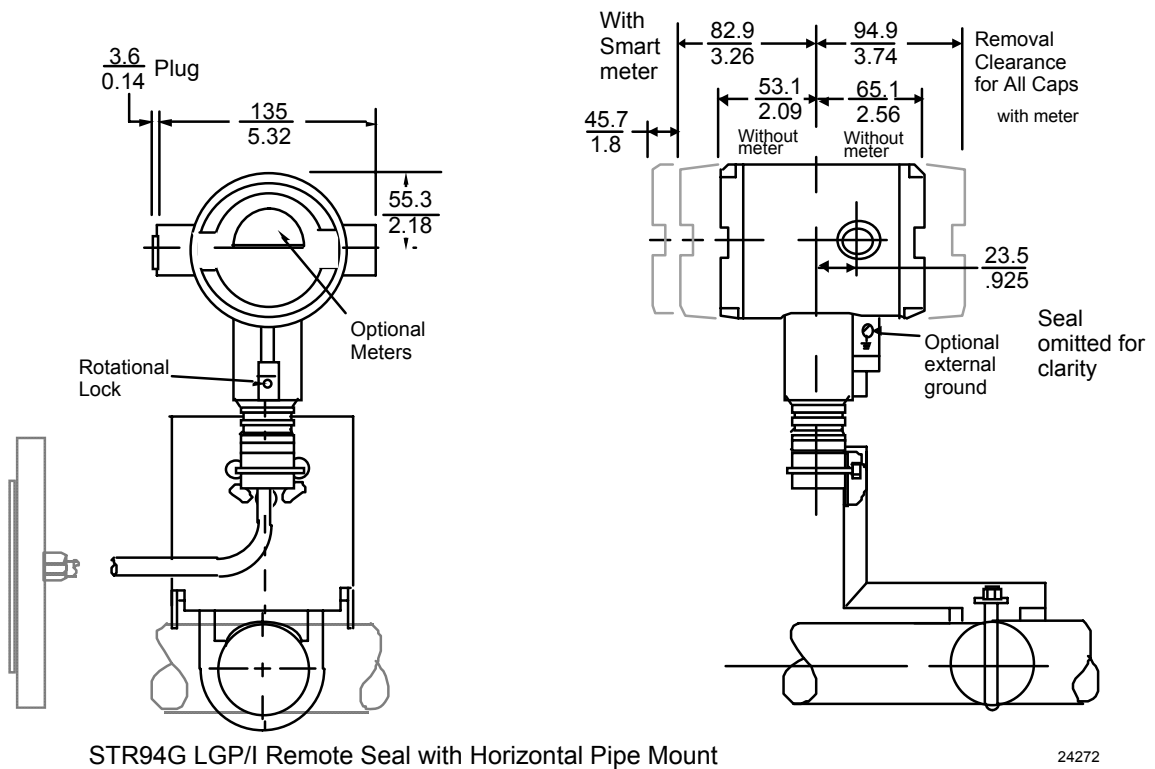
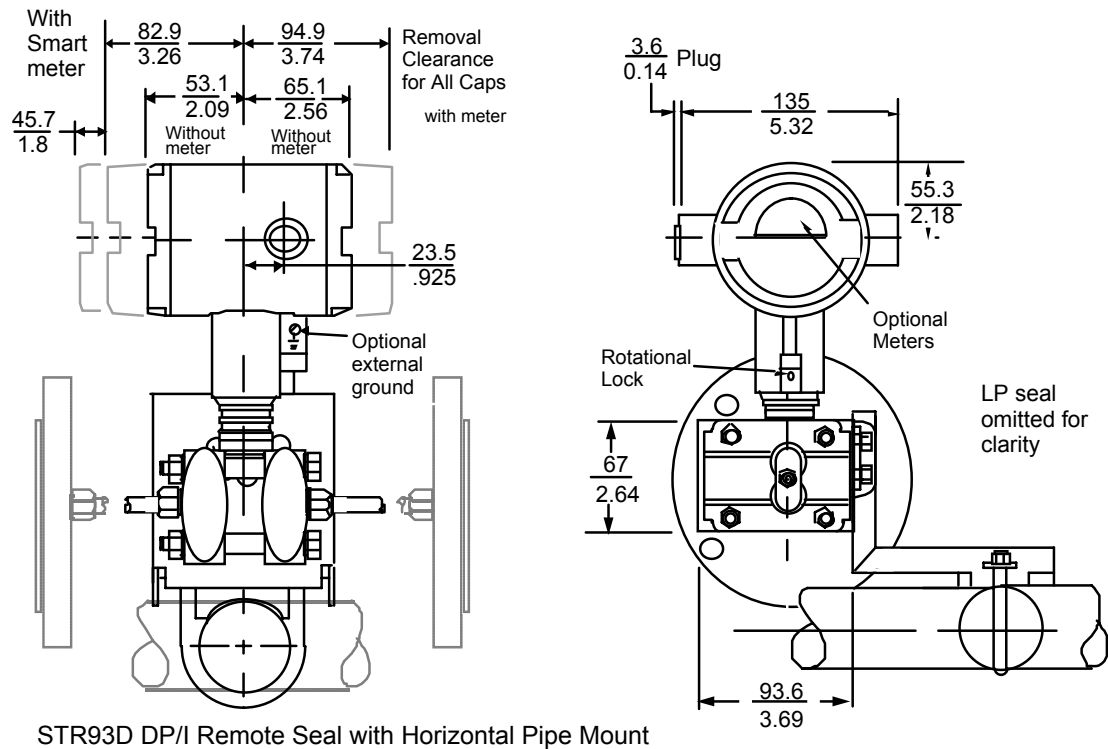

Figure 18—Density, direct acting transmitter configuration

Reference Dimensions: millimeters
Inches



24272

Figure 19—Approximate horizontal mounting dimensions for Remote Seal Transmitter.

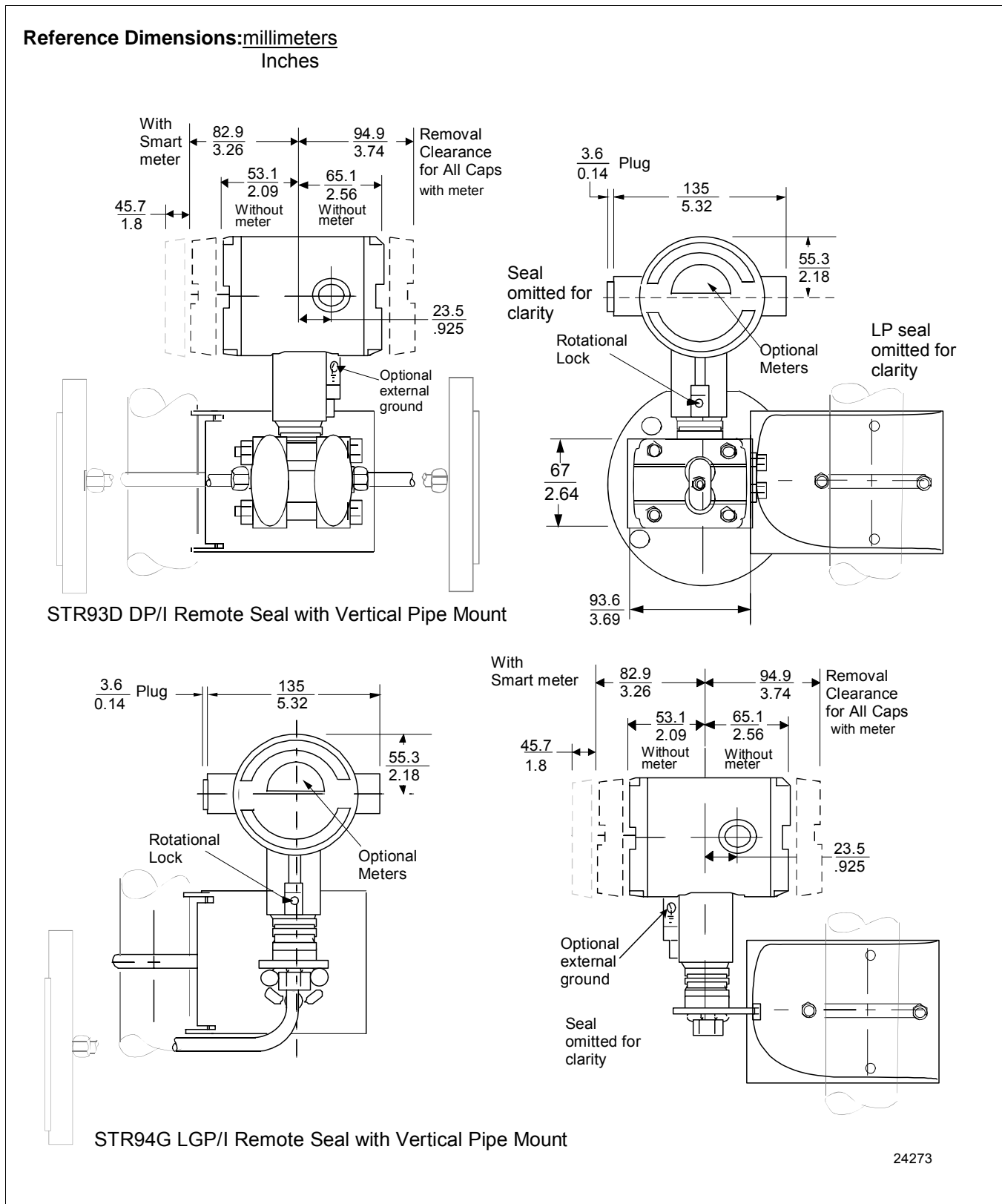

Figure 20—Approximate vertical mounting dimensions for Remote Seal Transmitter

Options	Ordering Information
<p>Mounting Bracket The angle-mounting bracket is available in either zinc-plated carbon steel or stainless steel and is suitable for horizontal or vertical mounting on a two-inch (50 millimeter) pipe, as well as wall mounting. An optional flat mounting bracket is also available in carbon steel for two inch (50 millimeter) pipe mounting.</p> <p>Indicating Meter (Options ME and SM) Two integral meter options are available. An analog meter (option ME) is available with a 0 to 100% linear scale. The Smart Meter (option SM) provides an LCD display for both analog and digital output and can be configured to display pressure in pre-selected engineering units.</p> <p>Lightning Protection (Option LP) A terminal block with circuitry that protects the transmitter from transient surges induced by nearby lightning strikes is available.</p> <p>HART® Protocol Compatibility (Options HC and H6) Optional electronics modules for the ST 3000 provides HART Protocol compatibility in either HART 5.x or 6.x formats. Transmitters with a HART Option are compatible with any HART enabled system that provides 5.x or 6.x format support.</p> <p>FOUNDATION Fieldbus (Option FF) Equips transmitter with FF protocol for use in 31.25 kbit/s FF networks. See document 34-ST-03-72 for additional information on ST 3000 Fieldbus transmitters.</p> <p>SIL2/SIL3 Certification (Option SL) This ST 3000 product is available for use with safety systems. With the SL option, we are fully certified to SIL 2 capability for single transmitters and SIL 3 capability for multiple transmitter use through TÜV Nord Sys Tec GmbH & Co. KG. (continued)</p>	<p>We are in compliance with the following SIL standards: IEC 61508-1: 1998; IEC 61508-2: 2000; IEC 61508-3: 1998</p> <p>NAMUR NE43 Compliance (Option NE) This option provides software that meets the NAMUR NE43 requirements for failsafe software. Transmitter failure information is generated when the measuring information is no longer valid. Transmitter failure values are: ≤ 3.6 mA and ≥ 21.0 mA. The normal ST 3000 ranges are ≤ 3.8 mA and ≥ 20.5 mA.</p> <p>Indicator Configuration (Option CI) Provides custom configuration of Smart Meters.</p> <p>Tagging (Option TG) Up to 30 characters can be added on the stainless steel nameplate mounted on the transmitter's electronics housing at no extra cost. Note that a separate nameplate on the meter body contains the serial number and body-related data. A stainless steel wired on tag with additional data of up to 4 lines of 28 characters is also available. The number of characters for tagging includes spaces.</p> <p>Transmitter Configuration (Option TC) The factory can configure the transmitter linear/square root extraction, damping time, LRV, URV and mode (analog/digital) and enter an ID tag of up to eight characters and scratchpad information as specified.</p> <p>Custom Calibration and ID in Memory (Option CC) The factory can calibrate any range within the scope of the transmitter's range and enter an ID tag of up to eight characters in the transmitter's memory.</p> <p>Contact your nearest Honeywell sales office, or</p> <p>In the U.S.: Honeywell Industrial Automation & Control 16404 North Black Canyon Hwy. Phoenix, AZ 85053 1-800-288-7491</p> <p>In Canada: The Honeywell Centre 155 Gordon Baker Rd. North York, Ontario M2H 3N7 1-800-461-0013</p> <p>In Latin America: Honeywell Inc. 480 Sawgrass Corporate Parkway, Suite 200 Sunrise, FL 33325 (954) 845-2600</p> <p>In Europe and Africa: Honeywell S. A. Avenue du Bourget 1 1140 Brussels, Belgium</p> <p>In Eastern Europe: Honeywell Praha, s.r.o. Budejovicka 1 140 21 Prague 4, Czech Republic</p> <p>In the Middle East: Honeywell Middle East Ltd. Khalifa Street, Sheikh Faisal Building Abu Dhabi, U. A. E.</p> <p>In Asia: Honeywell Asia Pacific Inc. Honeywell Building, 17 Changi Business Park Central 1 Singapore 486073 Republic of Singapore</p> <p>In the Pacific: Honeywell Pty Ltd. 5 Thomas Holt Drive North Ryde NSW Australia 2113 (61 2) 9353 7000</p> <p>In Japan: Honeywell K.K. 14-6 Shibaura 1-chrome Minato-ku, Tokyo, Japan 105-0023</p> <p>Or, visit Honeywell on the World Wide Web at: http://www.honeywell.com</p> <p>Specifications are subject to change without notice. (Note that specifications may differ slightly for transmitters manufactured before October 30, 1995.)</p>

Model Selection Guide (34-ST-16-34)

Instructions

- Select the desired Key Number. The arrow to the right marks the selection available.
- Make one selection from each table, I and II, using the column below the proper arrow.
- Select as many Table III options as desired (if no options are desired, specify 9X).
- A (*) denotes unrestricted availability. A letter denotes restricted availability.
- Restrictions follow Table IV.

Key Number I II III (Optional) IV
----- - --- - ----- - - - , - - , - - + XXXX

KEY NUMBER

Description	Selection	Avail.	
0-25" to 0-2700" H ₂ O/0-62.2 to 0-7000 mbar Body Rating*: 750 psi (51.7 bar) Compound Characterized	STR93D	↓	
0-20 to 0-500 psig/0-1.4 to 0-35 bar Body Rating*: 500 psi (35 bar)	STR94G		↓

* Remote seal system pressure rating is body rating or seal rating, whichever is less.

TABLE I - METER BODY

Description	Selection	Avail.	
Number of Seals	1 Remote Seal (High Side)	1 __	• •
	2 Remote Seals	2 __	• •
	1 Remote Seal (Low Side)	3 __	• •
	Value Added Model (VAM unit)	5 __	8 8
Fill Fluid (Meter Body)	Silicone (DC 200)	- 1 _	• •
	CTFE	- 2 _	q q
Construction	Non-Wetted Material		
In-Line Gauge	316 SS	__ A	•
	316 SS for Close-Couple	__ D	y
Dual Head DP	316 SS Heads	__ A	•
	316 SS Heads for Close-Couple connection	__ D	y
	316 SS with all-welded meter body	__ C	7

TABLE II - SEALS

Format for Seal Selection: Specify 12 characters						Availability	
			Common Required Seal			STR9xx	
Note: The first 3 characters are common to all seals. When selecting required seal, you must specify only the 9 selections within the required seal.						3D	4G
						Selection	
Secondary Fill	No Fill Fluid				0	3	3
	Silicone (DC 200)				1	•	•
	CTFE				2	•	•
	Silicone (DC 704)				3	p	p
	Neobee (M20) **				4	•	•
	Syltherm 800 ***				5	p	p
Connection of Remote Seal to Meter Body	No Capillary, No Nipple				0	3	3
	Capillary Length	5 feet	1.5 m	SS Armor	A	•	•
		10 feet	3.0 m		B	•	•
		15 feet	4.5 m		C	•	•
		20 feet	6.1 m		D	•	•
		25 feet	7.5 m		E	•	•
		35 feet	10.7 m		F	•	•
	Capillary Length	5 feet	1.5 m	PVC Coated SS Armor	G	•	•
		10 feet	3.0 m		H	•	•
		15 feet	4.5 m		J	•	•
		20 feet	6.1 m		K	•	•
		25 feet	7.5 m		L	•	•
		35 feet	10.7 m		M	•	•
2 inch long SS nipple close-coupled				2	z	z	
No Selection				0	•	•	
No Seal Attached to Core Transmitter				0000000000	3	3	
Flush Flanged Seal	Diaphragm Diameter	Flange Size	Flange Pressure Rating *		Selection		
	3.5"	3"	ANSI Class 150 ANSI Class 300 DIN DN80-PN40		AFA	•	
			Diaphragm	Upper Insert	Selection		
	Wetted Material		316L SS	316 SS	AA	•	
			Hastelloy C	316 SS	AB	•	
			Hastelloy C	Hastelloy C	AC	•	
			Monel	Monel	AE	•	
			Tantalum	Tantalum ^a	AF	1	
	Flange Material		CS (Nickel Plated)		1	•	
			316 SS		2	•	
Seal-Capillary Connection		Center of Seal		1	•		
		Side of Seal		2	9		
Calibration Rings		None		A	•		
		316 SS		B	5		
		Hastelloy C		C	5		
		Monel		D	5		

Table II continued next page

Availability
STR9xx ↓ ↓

TABLE II - SEALS (continued)

	Description		Selection	Availability	
				3D	4G
Flush Flanged Seal	Flushing Connections and Plugs** Metal plug material will be the same as Lower material, if metal plug is chosen - (SS Plug for CS Lower and Tantalum Clad)	None	----- 0	•	•
		One 1/4" with plastic plug	----- H	6	6
		One 1/4" with metal plug	----- J	6	6
		Two 1/4" with plastic plugs	----- M	6	6
		Two 1/4" with metal plugs	----- N	6	6
		One 1/2" with plastic plug	----- P	6	6
		One 1/2" with metal plug	----- Q	6	6
		Two 1/2" with plastic plugs	----- R	6	6
		Two 1/2" with metal plugs	----- S	6	6

Table II continued below

- * Standard facing 125-250 AARH RF (raised face) serrated surface finish.
- ** Limited vacuum availability.
- *** Minimum static pressure requirement. No vacuum allowed. See Specification Figure 13.
- **** Plastic Plugs are TEMPORARY ONLY to protect threads and MUST be REMOVED before installation
- a Tantalum Upper insert has Tantalum wetted parts and 316SS or CS non-wetted parts

STR9xx ↓ ↓

TABLE II - SEALS (continued)

	Diaphragm Diameter	Flange Size	Flange Pressure Rating *	Const. - See Spec. Figure 34-ST-03-57	Selection	Availability	
						3D	4G
Flush Flanged Seal with Lower	2.4"	1"	ANSI 150	22	--- BCA ---	•	•
			ANSI 300	22	--- BCC ---	•	•
		1-1/2"	ANSI 150	22	--- BGA ---	•	•
			ANSI 300	22	--- BGC ---	•	•
		2"	ANSI 150	22	--- BDA ---	•	•
			ANSI 300	22	--- BDC ---	•	•
		3"	ANSI 150	22	--- BFA ---	•	•
			ANSI 300	22	--- BFC ---	•	•
	2.9"	1/2"	ANSI 150	23	--- CAA ---	•	•
			ANSI 300	23	--- CCA ---	•	•
		1-1/2"	ANSI 150	22	--- CGA ---	•	•
			ANSI 300	22	--- CGC ---	•	•
		2"	ANSI 150	22	--- CDA ---	•	•
			ANSI 300	22	--- CDC ---	•	•
	4.1"	1/2"	ANSI 150	23	--- DAA ---	•	•
			ANSI 300	23	--- DCA ---	•	•
		1-1/2"	ANSI 150	23	--- DGA ---	•	•
			ANSI 300	23	--- DGC ---	•	•
		2"	ANSI 150	23	--- DDA ---	•	•
			ANSI 300	22	--- DDC ---	•	•
		3"	ANSI 150	22	--- DFA ---	•	•
ANSI 300			22	--- DFC ---	•	•	

Table II continued next page

Availability
STR9xx

TABLE II - SEALS (continued)

					3D	4G
Flush Flanged Seal with Lower (continued)	Wetted Material	Diaphragm	Lower	Selection		
		316L SS	316 SS	----- BA -----	•	•
		Hastelloy C	316 SS	----- BB -----	•	•
		Hastelloy C	Hastelloy C	----- BC -----	•	•
		Monel	Monel	----- BE -----	•	•
		Tantalum	316 SS	----- BF -----	1	1
		Tantalum	Hastelloy C	----- BG -----	1	1
	Tantalum	Tantalum Clad	----- BH -----	10	10	
	Non-Wetted Material (upper, upper insert)	Upper	Upper Insert	Selection		
		316 SS	316 SS	----- 4 -----	•	•
	Carbon Steel	316 SS	----- 5 -----	•	•	
Bolts***	No Selection		----- 0 -----	•	•	
Flushing Connections and Plugs** Metal plug material will be the same as Lower material, if metal plug is chosen - (SS Plug for CS Lower and Tantalum Clad)	None		----- 0 -----	•	•	
	One 1/4" with plastic plug		----- H -----	•	•	
	One 1/4" with metal plug		----- J -----	•	•	
	Two 1/4" with plastic plugs		----- M -----	•	•	
	Two 1/4" with metal plugs		----- N -----	•	•	
	One 1/2" with plastic plug		----- P -----	•	•	
	One 1/2" with metal plug		----- Q -----	•	•	
Two 1/2" with plastic plugs		----- R -----	•	•		
Two 1/2" with metal plugs		----- S -----	•	•		
Gasket	Klinger C-4401 (non-asbestos)		----- K -----	c	c	
	Grafoil		----- G -----	•	•	
	Teflon		----- T -----	c	c	
	Gylon 3510		----- L -----	d	d	
Flange Seal with Extended Diaphragm	Diaphragm Diameter	Flange Size	Flange Pressure Rating *	Selection		
	2.8"	3" (2.8" OD extension)	ANSI Class 150	----- EFA -----	•	•
			ANSI Class 300	----- EFC -----	•	•
			DIN DN80-PN40	----- EFM -----	•	•
	3.5"	4" (3.70" OD extension)	ANSI Class 150	----- FGA -----	•	•
			ANSI Class 300	----- FGC -----	•	•
			DIN DN100-PN40	----- FGP -----	•	•
	Wetted Material	Diaphragm	Ext. Tube	Selection		
		316L SS	316 SS	----- EA -----	•	•
		Hastelloy C	316 SS	----- EB -----	•	•
	Hastelloy C	Hastelloy C	----- EC -----	•	•	
Flange Material	CS (Nickel Plated)		----- 7 -----	•	•	
	316 SS		----- 8 -----	•	•	
Bolts	No Selection		----- 0 -----	•	•	
Extension Length	2"		----- 2 -----	•	•	
	4"		----- 4 -----	•	•	
	6"		----- 6 -----	•	•	
No Selection	No Selection		----- 0 -----	•	•	

Table II continued next page

- * Standard facing 125-250 AARH RF (raised face) serrated finish.
- ** Plastic Plugs are TEMPORARY ONLY to protect threads and MUST be REMOVED before installation
- *** Bolt material will be same as Upper Material. However, if Table III bolt/nut option chosen, seal bolt material will be the same.

STR9xx

TABLE II - SEALS (continued)

					3D	4G	
Diaphragm Diameter	Flange Size	Flange Pressure Rating Dependent on Customer Flange		Selection			
Pancake Seal	3.5"	3"	ANSI Class 150/300/600		___ GFA ___	•	•
	Wetted Material		Diaphragm	Body	Selection		
			316L SS	316 SS	___ GA ___	•	•
			Hastelloy C	316 SS	___ GB ___	•	•
			Hastelloy C	Hastelloy C	___ GC ___	•	•
			Monel	Monel	___ GE ___	•	•
	Tantalum	Tantalum ^a	___ GG ___	1	1		
	Non-Wetted Materials		No Selection		___ 0 ___	•	•
	No Selection		No Selection		___ 0 ___	•	•
	Calibration Rings		None		___ A ___	•	•
316 SS			___ B ___	5	5		
Hastelloy C			___ C ___	5	5		
Monel			___ D ___	5	5		
Flushing Connections and Plugs** Metal plug material will be the same as Lower material, if metal plug is chosen - (SS Plug for CS Lower and Tantalum Clad)		None		___ 0 ___	•	•	
		One 1/4" with plastic plug		___ H ___	6	6	
		One 1/4" with metal plug		___ J ___	6	6	
		Two 1/4" with plastic plugs		___ M ___	6	6	
		Two 1/4" with metal plugs		___ N ___	6	6	
		One 1/2" with plastic plug		___ P ___	6	6	
		One 1/2" with metal plug		___ Q ___	6	6	
Two 1/2" with plastic plugs		___ R ___	6	6			
Two 1/2" with metal plugs		___ S ___	6	6			

Table II continued below

a Tantalum Body has Tantalum wetted parts and 316SS non-wetted parts

*** Plastic Plugs are TEMPORARY ONLY to protect threads and MUST be REMOVED before installation

STR9xx

TABLE II - SEALS (continued)

					3D	4G	
Diaphragm Diameter	Flange Size	Flange Pressure Rating		Selection			
Chemical Tee "Taylor" Wedge	3.5"	Taylor Wedge 5" O.D.	750 psi		___ HMO ___	v	
	Wetted Material		Diaphragm	Body	Selection		
			316L SS	316 SS	___ HA ___	•	
			Hastelloy C	316 SS	___ HB ___	•	
	Hastelloy C		Hastelloy C	___ HC ___	•		
	Non-Wetted Material		No Selection		___ 0 ___	•	
	Bolts		No Selection		___ 0 ___	•	
Styles		No Selection		___ 0 ___	•		
No Selection		No Selection		___ 0 ___	•		

Table II continued next page

TABLE II - SEALS (continued)						Availability	
Diaphragm Diameter	Threaded Process Connection Size (NPT Female)	Seal Pressure Rating *		Selection	3D	4G	
		C.S. Bolts	304 SS Bolts				
Seal with Threaded Process Connection	2.4"	1/2" NPT	2500 psi	1250 psi	--- JGG ---	•	•
		3/4" NPT			--- JKG ---	•	•
		1" NPT			--- JLG ---	•	•
	2.9"	1/2" NPT	2500 psi	1250 psi	--- KJG ---	•	•
		3/4" NPT			--- KKG ---	•	•
		1" NPT			--- KLG ---	•	•
	4.1"	1/2" NPT	1500 psi	750 psi	--- LJG ---	•	•
		3/4" NPT			--- LKG ---	•	•
		1" NPT			--- LLG ---	•	•
	Wetted Material	Diaphragm	Lower	Selection			
		316L SS	Carbon Steel	--- JA ---	•	•	
		316L SS	316 SS	--- JB ---	•	•	
		Hastelloy C	316 SS	--- JC ---	•	•	
		Hastelloy C	Hastelloy C	--- JD ---	•	•	
		Monel	Monel	--- JE ---	•	•	
Tantalum		316 SS	--- JF ---	1	1		
Tantalum	Hastelloy C	--- JG ---	1	1			
Non-Wetted Material (upper)	CS (Nickel Plated) Stainless Steel		--- A ---	•	•		
			--- C ---	w	w		
Bolts***	Carbon Steel 304 SS		--- C ---	1	1		
			--- D ---	•	•		
Flushing Connections and Plugs** Metal plug material will be the same as Lower material, if metal plug is chosen - (SS Plug for CS Lower and Tantalum Clad)	None		--- 0 ---	•	•		
	One 1/4" with plastic plug		--- H ---	•	•		
	One 1/4" with metal plug		--- J ---	•	•		
	Two 1/4" with plastic plugs		--- M ---	•	•		
	Two 1/4" with metal plugs		--- N ---	•	•		
	One 1/2" with plastic plug		--- P ---	11	11		
	One 1/2" with metal plug		--- Q ---	11	11		
Two 1/2" with plastic plugs		--- R ---	11	11			
Two 1/2" with metal plugs		--- S ---	11	11			
Gasket	Klinger C-4401 (non-asbestos)		--- K ---	c	c		
	Grafoil		--- G ---	•	•		
	Teflon		--- T ---	c	c		
	Gylon 3510		--- L ---	d	d		

Table II continued next page

- * Caution: Maximum working pressure of STR93D transmitter is 750 psi and STR94G transmitter is 500 psig. Damage to sensor may result if pressure limit is exceeded.
- ** Plastic Plugs are TEMPORARY ONLY to protect threads and MUST be REMOVED before installation
- *** If Table III Bolt/Nut option is chosen, Seal bolts will ship as same material, and MAWP may change.

STR9xx ↓ ↓

TABLE II - SEALS (continued)

					3D	4G
	Diaphragm Diameter	Flange Size	Pressure Rating		Selection	
	Sanitary Seal	1.9"	2"	Customer clamp rating or 600 psi, whichever is less		___ MD0 ___
2.4"		2-1/2"	___ NE0 ___			• •
2.9"		3"	___ PF0 ___			• •
4.1"		4"	___ QG0 ___			• •
Wetted Material		Diaphragm	Body	Selection		
		316L SS	316 SS	___ N A ___	• •	
Non-Wetted Material		No Selection		___ 0 ___	• •	
Bolts		No Selection		___ 0 ___	• •	
Styles		Tri-Clover Tri-Clamp		___ 8 ___	• •	
Gasket		No Selection		___ 0 ___	• •	
Saddle Seal	Diaphragm Diameter	Size and Bolt Pattern	Seal Pressure Rating **		Selection	
			C.S. Bolts	304 SS Bolts		
	2.4" 8-Bolt Design	for 3" Pipe ? 4" pipe	1500 psi	1500 psi	___ RFK ___	• •
					___ RGK ___	• •
	2.4" 6-Bolt Design	for 3" Pipe ? 4" pipe	1250 psi	1250 psi	___ RPK ___	• •
					___ RQK ___	• •
	Wetted Material		Diaphragm	Lower Housing	Selection	
			316L SS	Carbon Steel	___ RA ___	• •
			316L SS	316 SS	___ RB ___	• •
			Hastelloy C	316 SS	___ RC ___	• •
			Hastelloy C	Hastelloy C	___ RD ___	• •
			316L SS	N/A-Body Only	___ SB ___	• •
Hastelloy C	N/A-Body Only	___ SC ___	• •			
Non-Wetted Material		Body	Bolts *, ***	Selection		
		Carbon Steel	Carbon Steel	___ B ___	1 1	
		316 SS	304 SS	___ C ___	• •	
No Selection		No Selection		___ 0 ___	• •	
Styles		No Selection		___ 0 ___	• •	
Gasket		Klinger C-4401 (non-asbestos)		___ K ___	• •	
		Grafoil		___ G ___	• •	
		Teflon		___ T ___	• •	
		Gylon 3510		___ L ___	• •	

* Bolts are not included with "Body only" selection.

** Caution: Maximum working pressure of STR93D transmitter is 750 psi and STR94G transmitter is 500 psig. Damage to sensor may result if pressure limit is exceeded.

*** If Table III Bolt/Nut option is chosen, Seal bolts will ship as same material, and MAWP may change.

		STR9xx	
		↓	↓
TABLE III - OPTIONS		Selection	3D 4G
None	00	•	•
Communication Options			
HART 5.x Protocol Compatible Electronics	HC	e	e
HART 6.x Protocol Compatible Electronics	H6	e	e
FOUNDATION Fieldbus Communications	FF	r	r
Indicating Meter Options			
Analog Meter (0-100 Even 0-10 Square Root)	ME	•	•
Smart Meter	SM	•	•
Custom Configuration of Smart Meter	CI	m	m
Local Zero	LZ	x	x
Local Zero and Span	ZS	s	s
Transmitter Housing & Electronics Options			
NAMUR Failsafe Software	NE	15	15
SIL 2 - TÜV Certified transmitter (requires HC and WP options)	SL	14	14
Lightning Protection	LP	•	•
Custom Calibration and I.D. in Memory	CC	•	•
Transmitter Configuration	TC	•	•
Write Protection (Delivered in the "enabled" position)	WP	•	•
Write Protection (Delivered in the "disabled" position)	WX	•	•
316 SS Electronics Housing - with M20 Conduit Connections	SH	n	n
1/2" NPT to M20 316SS Conduit Adapter (BASEEFA EEx d IIC)	A1	n	n
1/2" NPT to 3/4" NPT 316 SS Conduit Adapter	A2	u	u
Stainless Steel Housing with M20 to 1/2" NPT 316 SS Conduit Adapter (use for FM and CSA Approvals)	A3	i	i
Stainless Steel Customer Wired-On Tag (4 lines, 28 characters per line, customer supplied information)	TG	•	•
Stainless Steel Customer Wired-On Tag (blank)	TB	•	•
End Cap Live Circuit Warning Label in Spanish (only with ATEX 3D)	SP	a	a
End Cap Live Circuit Warning Label in Portuguese (only with ATEX 3D)	PG	a	a
End Cap Live Circuit Warning Label in Italian (only with ATEX 3D)	TL	a	a
End Cap Live Circuit Warning Label in German (only with ATEX 3D)	GE	a	a
Meter Body Options (Seal bolt material depends on Transmitter bolt material)			
A286 SS (NACE) Bolts and 304 SS (NACE) Nuts for Heads	CR	•	•
316 SS Bolts and 316 SS Nuts for Process Heads	SS	•	•
B7M Bolts and Nuts for Process Heads	B7	•	•
Remote Seal Options			
Gold Plated Seal Diaphragm (1 Seal)	G1	j	j
Gold Plated Seal Diaphragm (2 Seals)	G2	j	j
Teflon Coated Seal Diaphragm (1 Seal) - only for anti-sticking	N1	j	j
Teflon Coated Seal Diaphragms(2 Seals) - only for anti-sticking	N2	j	j
Transmitter Mounting Brackets Options			
Mounting Bracket - Carbon Steel	MB	•	•
Mounting Bracket - 304 SS	SB	•	•
Flat Mounting Bracket	FB	•	•
Services/Certificates Options			
Users Manual Paper Copy (Standard, HC or FF ships accordingly)	UM	•	•
Clean Transmitter & Seals for Oxygen or Chlorine Service with Certificate	OX	h	h
Over-Pressure Leak Test with F3392 Certificate	TP	•	•
Calibration Test Report and Certificate of Conformance (F3399)	F1	•	•
Certificate of Conformance (F3391)	F3	•	•
Certificate of Origin (F0195)	F5	•	•
FMEDA Certificate (SIL 1)	F6	•	•
NACE Certificate (F0198)	F7	•	•
NACE Certificate (F0198) for welded meter bodies only	F8	o	o
Marine Type Approvals (DNV, ABS, BV & LR)	MT	16	2
Warranty Options			
Additional Warranty - 1 year	W1	•	•
Additional Warranty - 2 years	W2	•	•
Additional Warranty - 3 years	W3	•	•
Additional Warranty - 4 years	W4	•	•

Table III continued next page

STR9xx

TABLE III - OPTIONS (continued)

TABLE III - OPTIONS (continued)				3D	4G
Approval Body	Approval Type	Location or Classification	Selection		
No hazardous location approvals			9X	•	<input type="checkbox"/>
Factory Mutual	Explosion Proof	Class I, Div. 1, Groups A,B,C,D	1C	•	•
	Dust Ignition Proof	Class II, III Div. 1, Groups E,F,G			
	Non-Incendive	Class I, Div. 2, Groups A,B,C,D			
	Intrinsically Safe	Class I, II, III, Div. 1, Groups A,B,C,D,E,F,G			
CSA	Explosion Proof	Class I, Div. 1, Groups B,C,D	2J	•	•
	Dust Ignition Proof	Class II, III, Div. 1, Groups E,F,G			
	Intrinsically Safe	Class I, II, III, Div. 1, Groups A,B,C,D,E,F,G			
SA (Australia)	Intrinsically Safe	Ex ia IIC T4	4G	•	•
	Non-Sparking	Ex n IIC T6 (T4 with SM option)			
ATEX*	Intrinsically Safe, Zone 0/1	Ex II 1 G EEx ia IIC T4, T5, T6	3S	•	•
	Flameproof, Zone 1	Ex II 2 G EEx d IIC T5, T6, Enclosure IP 66/67	3D	•	•
	Non-Sparking, Zone 2	Ex II 3 G EEx nA, IIC T6 (Honeywell). Enclosure IP 66/67	3N	•	•
	Multiple Marking** Int. Safe, Zone 0/1, or Flameproof, Zone 1, or Non-Sparking, Zone 2	Ex II 1 G EEx ia IIC T4, T5, T6 Ex II 2 G EEx d IIC T5, T6 Ex II 3 G EEx nA, IIC T6 (Honeywell) Enclosure IP 66/67	3H	•	•
INMETRO (Brazil)	Flameproof, Zone 1	Ex d IIC T5	6D	•	•

*See ATEX installation requirements in the ST 3000 User's Manual

**The user must determine the type of protection required for installation of the equipment. The user shall then check the box [] adjacent to the type of protection used on the equipment certification nameplate. Once a type of protection has been checked on the nameplate, subsequently the equipment shall not be reinstalled using any of the other certification types.

TABLE IV

Factory Identification	XXXX	•	•
------------------------	------	---	---

RESTRICTIONS

Restriction Letter	Available Only With		Not Available With	
	Table	Selection	Table	Selection
a	III	3D or 3H		
b	Select only one option from this group			
c			II	----- BF ----- ----- BG ----- ----- BH ----- ----- JF ----- ----- JG -----
d	II	----- BF ----- ----- BG ----- ----- JF ----- ----- JG -----		
e			III	4G
g	II	_ A ----- _ B ----- _ C ----- _ G ----- _ H ----- _ J ----- _ 2 -----		
h	I, II	_ 2 _ 2 -----		
i	III	1C or 2J		
j			II	----- AF ----- ----- BF ----- ----- BG ----- ----- BH ----- ----- GG ----- ----- JF ----- ----- JG -----
m	III	SM		
n			III	1C, 2J
o	III	CR		
p			II	DC704 and Syltherm 800 fills and close-couple require SS seal upper. ----- BCA _ 5 ----- ----- CAA _ 5 ----- ----- CCA _ 5 ----- ----- CCC _ 5 ----- ----- DAA _ 5 ----- ----- DCA _ 5 ----- ----- DCC _ 5 ----- ----- DGA _ 5 ----- ----- DGC _ 5 ----- ----- DDA _ 5 ----- ----- GE ----- ----- A ----- ----- B -----
q	II	0 ----- 2 ----- 4 -----		
r			III	TC, ME, 4G, 3S
s			III	FF, ME

Restrictions continued next page

RESTRICTIONS - (continued)

Restriction Letter	Available Only With		Not Available With	
	Table	Selection	Table	Selection
u	III	1C, 2J		
v	I	2__		
w			II	_____JA_____
x	III	FF, SM		
y			III	MB, SB, FB DC704 and Syltherm 800 fills and close-couple require SS seal upper. ____BCA__5____ ____CAA__5____ ____CCA__5____ ____CCC__5____ ____DAA__5____ ____DCA__5____ ____DCC__5____ ____DGA__5____ ____DGC__5____ ____DDA__5____ ____GE____ ____A____ ____B____
			I	2
			II	A - M
z	I	__D		
1			III	F7
2			III	FB
3	I	5__, 1__		
5			II	_____0
6			II	_____A_
7			I	1, 3
			III	CR
8			III	CC,G1,G2,T1,T2,OX,TP,MT,WP
9	II	____AA2____		
		____AB2____		
10	II	_____0_	II	_____T
			III	F7
11			II	____JG____
				____JK____
				____JL____
				____CA____
				____CC____
14	III	HC, WP	III	FF, 00
15			III	FF
16	I	__C		

- Notes:**
- See ST-83 for Published Specials with pricing.
 - See ST-89 and User's Manual for part numbers.
 - See COMS Order Entry Information including TC, manuals, certificates, drawings and SPINS.
 - See ST-OD-1 for tagging, ID, Transmitter Configuration (TC) and calibration including factory default values.
 - To request a quotation for a non-published "special", fax RFQ with Application Data Sheet (34-ST-18-01) to Marketing Applications.

Dimensions and drawings

Type	Size	Non-Wetted Material	Wetted Materials		Construction See Figure	Dimension 3.5" Diaphragm Dia. (in.)	
			Diaphragm	Upper Insert		A	B
			Flush Flanged Seal	3" 150		CS	All
316L SS Hast C	N/A SS	21b 21b			7.50		0.94 0.94
SS	Hast C	Hast C			21a	7.50	1.08
	Monel Tantalum	Monel Tantalum			21a 21a	7.50	1.08 1.08
3" 300	CS	All		All	21a	8.25	1.26
		316L SS Hast C		N/A SS	21b 21b	8.25	1.12 1.12
	SS	Hast C		Hast C	21a	8.25	1.26
		Monel Tantalum		Monel Tantalum	21a 21a	8.25	1.26 1.26
3" 600	CS	All		All	21a	8.25	1.50
		316L SS Hast C		N/A SS	21b 21b	8.25	1.50 1.50
	SS	Hast C		Hast C	21a	8.25	1.50
		Monel Tantalum		Monel Tantalum	21a 21a	8.25	1.50 1.50
DN80- PN40	CS	All		All	21a	7.87	1.02
		316L SS Hast C		N/A SS	21b 21b	7.87	0.94 0.94
	SS	Hast C		Hast C	21a	7.87	1.02
		Monel Tantalum		Monel Tantalum	21a 21a	7.87	1.02 1.02

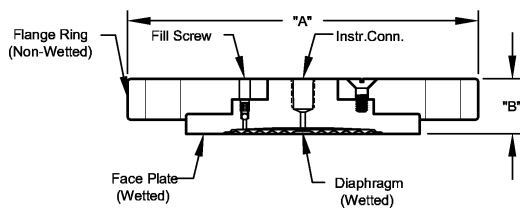

Figure 21a. Flush Flanged Seal

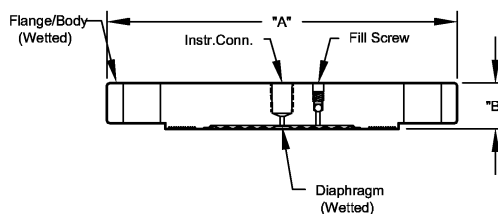

Figure 21b. Flush Flanged Seal

Dimensions and drawings, cont.

Type	Size	Dim.	2.4" Diaph. Dia. (in.)	2.9" Diaph. Dia. (in.)	4.1" Diaph. Dia. (in.)	
Flush Flanged Seal With Lower	150#	1/2"	A	□ 3.50	□ 4.00	□ 5.25
			B0	□ 1.72	□ 1.72	□ 1.84
			B1	□ 1.72	□ 1.72	□ 1.84
		B2	□ 2.22	□ 2.22	□ 2.34	
		1"	A	○ 4.25	○ 4.00	○ 5.25
	B0		○ 1.12	○ 1.72	○ 1.84	
	B1		○ 1.62	○ 1.72	○ 1.84	
	1-1/2"	A	○ 5.00	○ 5.00	○ 5.25	
		B0	○ 1.17	○ 1.72	○ 1.78	
		B1	○ 1.67	○ 1.72	○ 2.12	
	2"	A	○ 6.00	○ 6.00	○ 6.00	
		B0	○ 1.34	○ 1.34	○ 2.12	
		B1	○ 1.84	○ 1.84	○ 2.12	
	3"	A	○ 7.50	○ 7.50	○ 7.50	
		B0	○ 1.53	○ 1.53	○ 1.63	
		B1	○ 2.03	○ 2.03	○ 2.03	
	300#	1"	A	○ 4.88	□ 4.00	□ 5.25
			B0	○ 1.27	□ 1.72	□ 1.88
			B1	○ 1.77	□ 1.72	□ 2.12
	1-1/2"	A	○ 6.12	○ 6.12	□ 5.25	
B0		○ 1.40	○ 1.40	□ 2.12		
B1		○ 1.90	○ 1.96	□ 2.12		
2"	A	○ 6.50	○ 6.50	○ 6.50		
	B0	○ 1.47	○ 1.47	○ 1.67		
	B1	○ 1.97	○ 1.97	○ 2.17		
3"	A	○ 8.25	○ 8.25	○ 8.25		
	B0	○ 2.09	○ 2.09	○ 1.81		
	B1	○ 2.21	○ 2.21	○ 2.21		
600#	1"	A	○ 4.88	□ 4.50	○ 5.25	
		B0	○ 1.84	□ 2.15	○ 2.26	
		B1	○ 1.84	□ 2.15	○ 2.26	
1-1/2"	A	○ 6.12	○ 6.12	○ 5.25		
	B0	○ 1.78	○ 1.53	○ 2.39		
	B1	○ 2.03	○ 2.09	○ 2.39		
2"	A	○ 6.50	○ 6.50	○ 6.50		
	B0	○ 1.65	○ 1.65	○ 1.85		
	B1	○ 2.15	○ 2.15	○ 2.25		
3"	A	○ 8.25	○ 8.25	○ 8.25		
	B0	○ 2.28	○ 2.28	○ 2.28		
	B1	○ 2.40	○ 2.40	○ 2.40		
B2	○ 2.80	○ 2.80	○ 2.80			

B0 = Without Flush
B1 = B Dimension With 1/4 NPT Flush
B2 = B Dimension With 1/2 NPT Flush

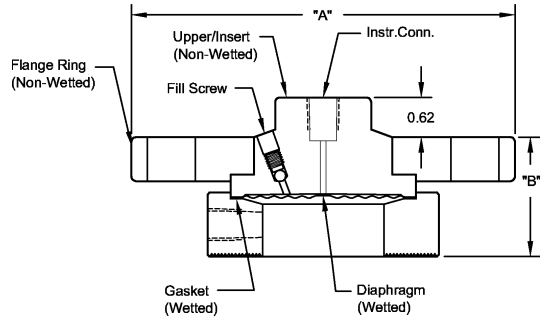

Figure 22 Flush Flanged Seal with Lower

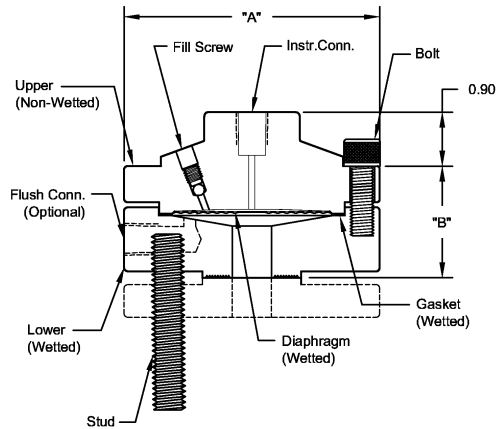

Figure 23 Flush Flanged Seal with Lower

Note: 0.90 Dimension is 0.70 for 4.1 Dia. Diaphragm

Dimensions and drawings, cont.

Type	Size	Dim.	2.8" Diaph. Dia. (in.)	3.5" Diaph. Dia. (in.)
Flanged Seal With Extended Diaphragm	3" 150	A	7.50	-
		B	0.94	-
		C	2.80	-
	3" 300	A	8.25	-
		B	1.12	-
		C	2.80	-
	DIN DN80- PN40	A	7.87	-
		B	0.94	-
		C	2.80	-
	4" 150	A	-	9.00
		B	-	0.94
		C	-	3.70
4" 300	A	-	10.00	
	B	-	1.25	
	C	-	3.70	
DIN DN100- PN40	A	-	9.25	
	B	-	0.94	
	C	-	3.70	

* Designed to mate with Sch 40 pipe

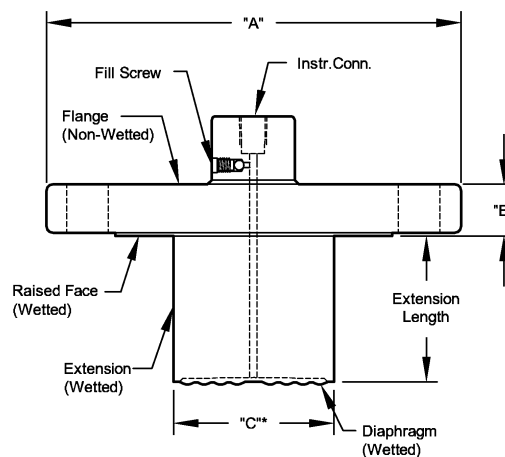

Figure 24 Flange Extended Seal

Type	Size	Dimension	3.5" Diaph. Dia. (in.)
Pancake Seal	150/300/600	A	5.00
		B	1.08

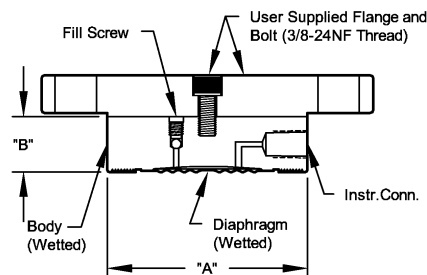

Figure 25 Pancake Seal

Type	Size	Dimension	3.5" Diaph. Dia. (in.)
Chemical Tee "Taylor Wedge" Seal	750 psi	A	5.00
		B	0.50

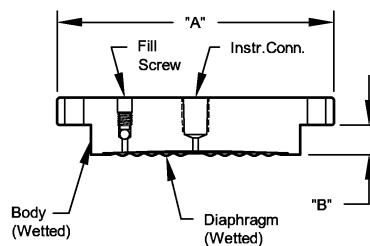

Figure 26 Chemical Tee "Taylor Wedge" Seal

Dimensions and drawings, cont.

Type	Size	Dim.	2.4" Diaph. Dia. (in.)	2.9" Diaph. Dia. (in.)	4.1" Diaph. Dia. (in.)
Seal With Threaded Process Connection	1/4" or 1/2"	A	3.50	4.00	5.25
		B0	1.66	1.66	1.79
		B1	1.66	1.66	1.79
		B2	2.16	2.16	2.14
	3/4" or 1"	A	3.50	4.00	5.25
		B0	1.66	1.66	1.79
	B1	1.66	1.66	1.79	
	B2	2.16	2.16	2.14	

B0 = B dimension for No Flush
B1 = B dimension for 1/4 NPT
B2 = B dimension for 1/2 NPT

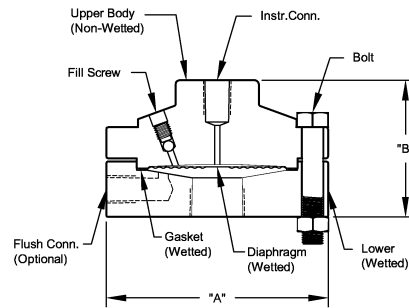

Figure 27 Threaded Process Connection

Type	Size	Dim.	1.9" Diaph. Dia. (in.)	2.4" Diaph. Dia. (in.)	2.9" Diaph. Dia. (in.)	4.1" Diaph. Dia. (in.)
Sanitary Seal	2"	A	2.50	-	-	-
		B	1.42	-	-	-
	2-1/2"	A	-	3.00	-	-
		B	-	1.28	-	-
	3"	A	-	-	3.57	-
		B	-	-	1.38	-
	4"	A	-	-	-	4.68
		B	-	-	-	1.60

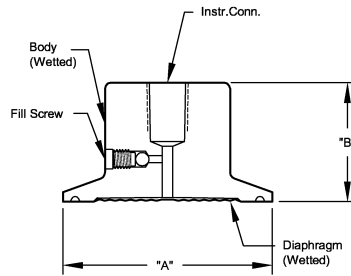

Figure 28 Sanitary Seal

Dimensions and drawings, cont.

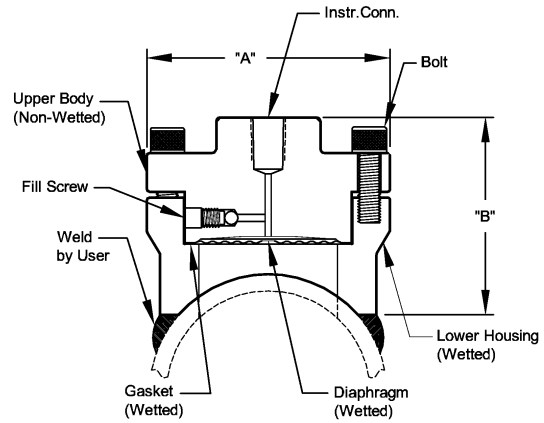

Figure 29 3" Saddle Seal

Type	Size	Dimension	2.4" Diaph. Dia.
Saddle Seal	3"	A	3.50
		B	2.90
	4" or larger	A	3.50
		B	3.04

Note: Specify 6 or 8 Bolt Pattern

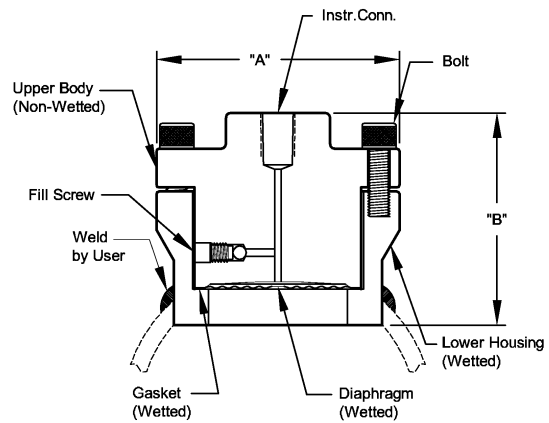

Figure 30 4" or larger Saddle Seal

SIZE	RATING	DIM.	1/4 NPT	1/2 NPT
3"	150/600#	A	5.00	5.00
		B	1.00	1.50
		C	3.00	3.00

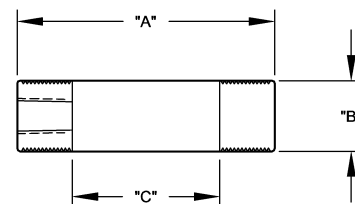

Figure 31 Calibration Ring

ST 3000® is a registered trademark of Honeywell International Inc.
HART* is a trademark of the Hart Communication Foundation.
FOUNDATION™ is a trademark of the Fieldbus Foundation.

Honeywell

Honeywell Process Solutions
Industrial Measurement and Control
Honeywell International Inc.
2500 W. Union Hill Drive
Phoenix, Arizona 85027

©Honeywell International Inc.

Free Manuals Download Website

<http://myh66.com>

<http://usermanuals.us>

<http://www.somanuals.com>

<http://www.4manuals.cc>

<http://www.manual-lib.com>

<http://www.404manual.com>

<http://www.luxmanual.com>

<http://aubethermostatmanual.com>

Golf course search by state

<http://golfingnear.com>

Email search by domain

<http://emailbydomain.com>

Auto manuals search

<http://auto.somanuals.com>

TV manuals search

<http://tv.somanuals.com>