

EQUIP™ Series Indoor Fixed Mini Dome Network Camera

NTSC / PAL

HD3MDIP HD3MDIPX

User Guide

Revisions

Issue	Date	Revisions
A	09/09	New document for HD3MDIP/X release. Generally describes the functionality in the firmware of the HD3MDIP/X camera.
V1 A	01/10	New version number and release date.

Contents

Figures	5
Tables	7
About This Document	9
Overview of Contents	9
Cautions and Warnings	10
FCC Compliance Statement	10
Manufacturer's Declaration of Conformance	11
North America	11
Europe	11
Warranty and Service	11
1 Introduction	13
Features	13
2 Installation and Setup	15
Before You Begin	15
Unpack Everything	15
Equipment Required	16
Overview of Installation Procedure	16
Camera Components and Functions	17
Camera Installation	18
Preparing the Camera	18
Preparing the Mounting Surface	18
Connecting the Wires	19
Mounting the Camera	24
Restore Factory Defaults	25
Adjusting the Camera FOV (Field of View)	25
Adjusting the Lens Focus	26
Securing the Enclosure Cover	27
3 Installing the Honeywell IP Utility and HD3MDIP/X Web-Client Software	29
About the Honeywell IP Utility and Web-Client	29
About the Honeywell IP Utility	29
About the Web-Client	30
User Profiles: Honeywell IP Utility and Web-Client	30
Step 1: Confirm Your System Requirements	31
Step 2: Install the Honeywell IP Utility Software	32
Downloading the EQUIP Series Installation Guides	32
Step 3: Log Onto the IP Utility and Discover Network Devices	33
Step 4: Connect to a Device and Configure Network Settings	34
Connecting to or Disconnecting From Devices	35
Configuring the IP Network Settings Automatically or Manually	35
Interfacing with the EQUIP Device Via a Network Video Recorder	38

Step 5: Launch the Web-Client to View Live Video38
Uninstalling IP Utility, Bonjour or the ActiveX Plug-in Software40
Uninstalling IP Utility Using the Start Menu41
Uninstalling IP Utility or IP ActiveX Using the Control Panel41
4 IP Camera Web-Client	43
Overview43
User Profiles44
Logging On and Off the HD3MDIP/X IP Web-Client44
Launching the Web-Client from IP Utility45
Logging Onto the Web-Client from Internet Explorer46
Logging Out of the Web-Client46
Navigating the User Interface47
Live View49
Device Settings49
IP and Firmware Settings on the Device Information Tab50
Compression Settings51
Video Codec Settings Tab52
Statistics: Received Bit Rate and Frame Rate54
Camera Setup55
Auto Exposure55
White Balance.57
Video Analytics57
Sabotage Detection.58
Configuring Video Motion Detection61
Alarm and Audio62
Alarm Settings62
Audio Settings63
Appendix A Mounting Template.	65
Appendix B Troubleshooting	67
Technical Support67
Problem: Lens Out of Optical Focus67
Problem: Live View Does Not Display the Expected Video68
Problem: Cannot Connect to a Device.68
Appendix C Specifications	69
Appendix D Glossary	73
Index.	75

Figures

Figure 2-1	HD3MDIP/X Camera Components	17
Figure 2-2	Mounting Template	18
Figure 2-3	Audio and Alarm PINs	19
Figure 2-4	Normal Alarm States	20
Figure 2-5	Alarm Connection	20
Figure 2-6	Camera and Cables	22
Figure 2-7	Wiring Connection Shown on Board	22
Figure 2-8	Gimbal Adjustment	26
Figure 2-9	Installing the Enclosure Cover.	27
Figure 3-1	Accessing Your Installation Documents.	32
Figure 3-2	Honeywell IP Utility Log On Window	33
Figure 3-3	Honeywell IP Utility User Interface.	34
Figure 3-4	Set the IP Network Settings Automatically or Manually	36
Figure 3-5	ActiveX Prompt.	39
Figure 3-6	Web-Client Interface After Logging On	40
Figure 4-1	Launching the HD3MDIP/X Web-Client from IP Utility	45
Figure 4-2	Web-Client Window Layout: Administrator Log On	47
Figure 4-3	Web-Client: Administrator User	48
Figure 4-4	Web-Client: Guest User	49
Figure 4-5	Device Settings	50
Figure 4-6	IP and Firmware Settings: Device Information Tab	51
Figure 4-7	Compressions Settings Tab: Primary Stream	52
Figure 4-8	Video Codec Settings Tab Available Functions	52
Figure 4-9	Video Codec Settings, Quality Priority Selected	54
Figure 4-10	Camera Setup	55
Figure 4-11	Video Analytics Tab	58
Figure 4-12	Tamper Detection Settings on the Video Analytics Tab.	58
Figure 4-13	Video Analytics Alarm Message	59
Figure 4-14	Video Analytics: Defining a Region	62
Figure 4-15	Audio Settings	63
Figure B-1	Limited or No Connection Message.	68
Figure C-1	HD3MDIP/X Side View with Dimensions	70
Figure C-2	HD3MDIP/X Side View Dimensions without Skirt	71
Figure C-3	HD3MDIP/X Side View Dimensions with Adapter Plate	71
Figure C-4	HD3MDIP/X Bottom View with Dimensions	71

Figures

Tables

Table 1-1	Fixed Mini Dome Network Camera Model Numbers	13
Table 2-1	Audio and Alarm Connector PIN Definitions	19
Table 3-1	User Profiles for Honeywell IP Utility and the Web-Client	30
Table 3-2	PC Minimum System Requirements	31
Table 3-3	Items Installed On Your System	31
Table 3-4	IP Network Device Setting Options.	36
Table 4-1	User Roles and Privileges	44
Table 4-2	Tabs/Views in the Web-Client Application	48
Table 4-3	Compression Settings	53
Table 4-4	Auto Exposure Settings.	56
Table 4-5	White Balance Settings	57
Table 4-6	Blur Threshold Values	59
Table 4-7	Blinding Threshold Values	60
Table 4-8	Scene Change Threshold Values	61

About This Document

This document introduces the Honeywell HD3MDIP/X True Day/Night Indoor Network Camera. It covers how to install and operate the HD3MDIP/X in a network environment.





This document is intended for system installers, administrators, and operators.

Overview of Contents

This document contains the following chapters and appendixes:

- [Chapter 1, Introduction](#), introduces the Honeywell HD3MDIP/X Network Camera and gives a functional overview of its components.
- [Chapter 2, Installation and Setup](#), provides procedures for installing cameras, adjusting the lens, and setting up a network camera environment.
- [Chapter 3, Installing the Honeywell IP Utility and HD3MDIP/X Web-Client Software](#), describes how to install the Honeywell IP Utility and set up administrator privileges.
- [Chapter 4, IP Camera Web-Client](#), describes how to use the Web-Client application to view video and configure the available settings for the network camera.
- [Appendix A, Mounting Template](#), provides a mounting template for the HD3MDIP/X camera.
- [Appendix B, Troubleshooting](#), lists common problems encountered when setting up the network camera.
- [Appendix C, Specifications](#), provides specifications for the HD3MDIP/X camera.
- [Appendix D, Glossary](#), explains terms and initializations used in this guide.
- The [Index](#) provides quick access to commonly searched terms.

Cautions and Warnings

 CAUTION RISK OF ELECTRIC SHOCK DO NOT OPEN	  THIS SYMBOL INDICATES THAT DANGEROUS VOLTAGE CONSTITUTING A RISK OF ELECTRIC SHOCK IS PRESENT WITHIN THE UNIT.
CAUTION: TO REDUCE THE RISK OF ELECTRIC SHOCK, DO NOT REMOVE THE COVER. NO USER-SERVICEABLE PARTS INSIDE. REFER SERVICING TO QUALIFIED SERVICE PERSONNEL.	 THIS SYMBOL INDICATES THAT IMPORTANT OPERATING AND MAINTENANCE INSTRUCTIONS ACCOMPANY THIS UNIT.

Installation and servicing should be performed only by qualified and experienced technicians to conform to all local codes and to maintain your warranty.

WARNING! 24 VAC models require the use of CSA Certified/UL Listed Class 2 power adapters to ensure compliance with electrical safety standards. Power over Ethernet (PoE) should meet the IEEE 802.3 af PoE standard.

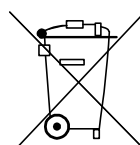

WEEE (Waste Electrical and Electronic Equipment). Correct disposal of this product (applicable in the European Union and other European countries with separate collection systems). This product should be disposed of, at the end of its useful life, as per applicable local laws, regulations, and procedures.



Caution When powering the camera from 24 VAC, a UPS source should be considered to ensure satisfactory performance.

FCC Compliance Statement

Information to the User: This equipment has been tested and found to comply with the limits for a Class B digital device. Pursuant to Part 15B of the FCC Rules, these limits are designed to provide reasonable protection against harmful interference in a residential installation. This equipment generates, uses, and can radiate radio frequency energy and, if not installed and used in accordance with the instruction manual, may cause harmful interference to radio communications. However, there is no guarantee that interference will not occur in a particular installation.

If this equipment does cause harmful interference to radio or television reception, which can be determined by turning the equipment off and on, the user is encouraged to try to correct the interference. For example, try reorienting or relocating the receiving antenna, increasing the separation between the equipment and receiver, or connecting the equipment to an outlet on a different circuit.

Caution Changes or modifications not expressly approved by the party responsible for compliance could void the user's authority to operate the equipment.

This Class B digital apparatus complies with Canadian ICES-003.

Manufacturer's Declaration of Conformance

North America

The equipment supplied with this guide conforms to UL 60950-1 and CSA C22.2 No. 60950-1.

Europe

The manufacturer declares that the equipment supplied with this guide is compliant with the essential protection requirements of the EMC directive 2004/108/EC and the Low Voltage Directive LVD 2006/95/EC, conforming to the requirements of standards EN 55022 for emissions, EN 50024 for immunity, and EN 60950 for Electrical Equipment safety.

Warranty and Service

Subject to the terms and conditions listed on the Product warranty, during the warranty period Honeywell will repair or replace, at its sole option, free of charge, any defective products returned prepaid.

In the event you have a problem with any Honeywell product, please call Customer Service at 1.800.796.CCTV for assistance or to request a **Return Merchandise Authorization (RMA)** number.

Be sure to have the model number, serial number, and the nature of the problem available for the technical service representative.

Prior authorization must be obtained for all returns, exchanges, or credits. **Items shipped to Honeywell without a clearly identified Return Merchandise Authorization (RMA) number may be refused.**

Introduction

Honeywell HD3MDIP/X color network cameras provide high picture quality remote video surveillance over a network connection. See [Table 1-1](#) for descriptions of the camera models.

Table 1-1 Fixed Mini Dome Network Camera Model Numbers

Model number	Description
HD3MDIP	True Day/Night 720p, 3.3 – 12 mm VFAI Lens NTSC
HD3MDIPX	True Day/Night 720p, 3.3 – 12 mm VFAI Lens PAL

Features

The Honeywell HD3MDIP/X color network camera features:

- HD, SVGA, VGA, QVGA resolutions
- 1/4" color CMOS progressive scan sensor
- Moveable Infrared (IR) cut filter ensures excellent low light performance
- Camera Sabotage Detection
- Video Motion Detection
- MPEG-4 and MJPEG compression
- Dual digital video streams simultaneously, independently configurable
- Remote firmware updates
- Supports both Dynamic and Static IP address assignment
- Multiple levels of password protected remote access prevents unauthorized users from altering system settings
- Includes advanced IP locator software to make system setup easy
- Web server for remote setup of camera video and network parameters
- 24 VAC or PoE IEEE 802.3af choice of power inputs
- Supports input and output alarm contacts
- Supports bi-directional audio
- Local video out – aim and focus

Installation and Setup

This chapter describes how to:

- Mount the camera
- Adjust the camera for the clearest image
- Set up the camera in a network system

Before You Begin

Please carefully read this guide before you install the HD3MDIP/X network camera.

Keep this guide for future reference.

Before installing the camera, Honeywell recommends that you check www.honeywellvideo.com/products/cameras/ to find your camera and download the latest manuals and software updates.

Unpack Everything

Check that the items received match those listed on the order form and packing slip. The HD3MDIP/X packing box should include, in addition to a Quick Install Guide:

- One fully-assembled HD3MDIP/X camera, including factory-installed BNC connector for local video out aim and focus
- One adapter plate
- One HD3MDIP/X hardware kit that includes mounting screws and screw caps
- One BNC cable for local video out - aim and focus
- One mounting template
- One product warranty
- One CD containing the software and this User Guide

If any parts are missing or damaged, contact the dealer from which you purchased your camera or call Honeywell Customer Service (see [Warranty and Service](#)).

Equipment Required

The following tools might help you to complete the installation:

- Drill
- Screwdrivers
- Wire cutters

Overview of Installation Procedure

Note Please familiarize yourself with the installation procedure and complete each step in the exact sequence given.

The initial installation of an HD3MDIP/X camera consists of the following steps:

Step	See ...
1 Preparation	page 18
2 Connect the wiring. Mount the camera.	page 21 page 24
3 Adjust the camera angle, position, and focus for optimum image.	page 25
4 Secure the enclosure cover.	page 27
5 Program the camera.	page 55

Camera Components and Functions

The HD3MDIP/X Network Camera consists of a fully-integrated enclosure with camera and lens. The wiring can be completely concealed to reduce the risk of tampering.

Figure 2-1 HD3MDIP/X Camera Components

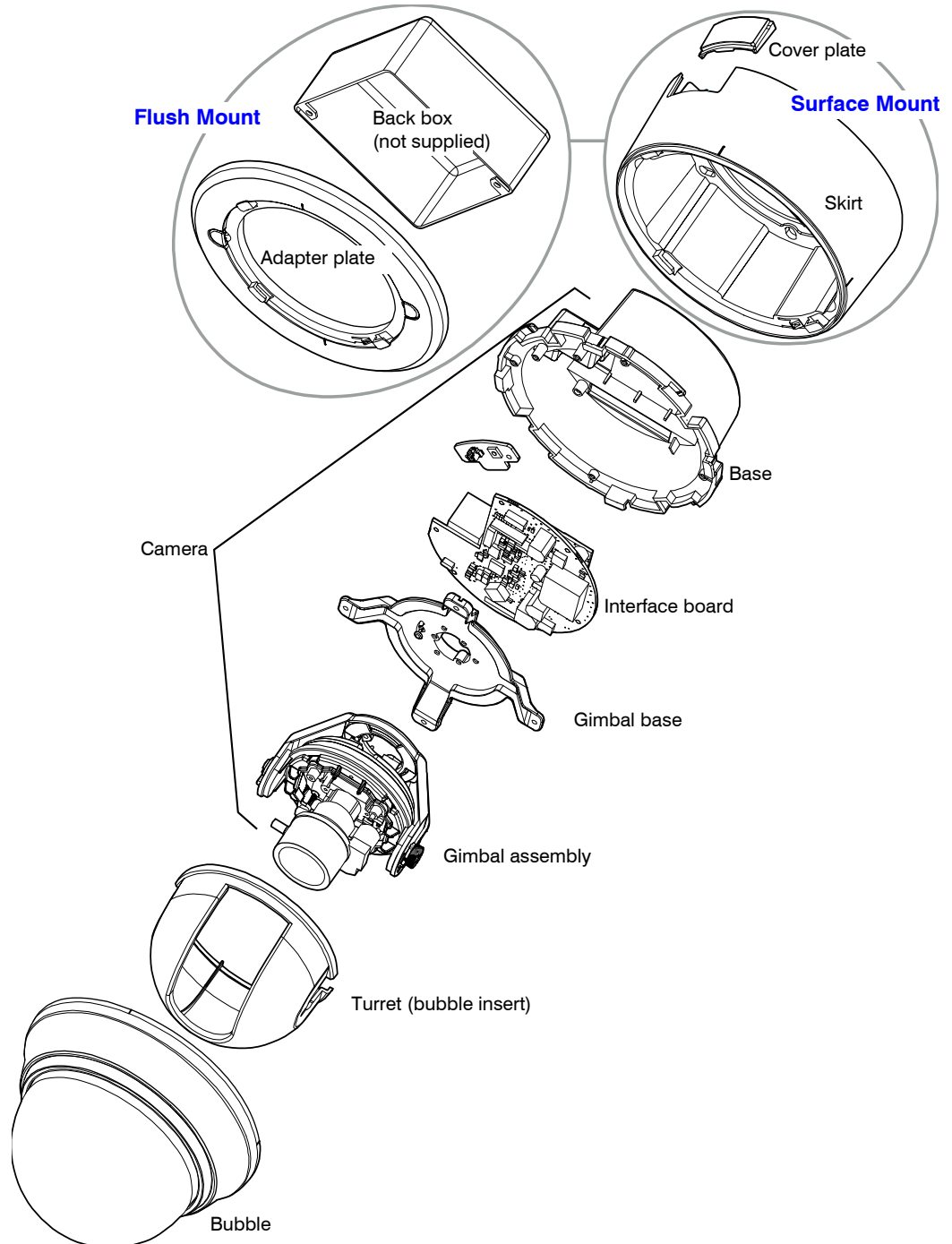

Camera Installation

Preparing the Camera

1. Rotate the bubble counterclockwise until it disconnects.
2. Pull the turret to remove it.
3. Rotate the camera counterclockwise until it disconnects from the skirt.
4. Set aside the bubble, turret, and camera.

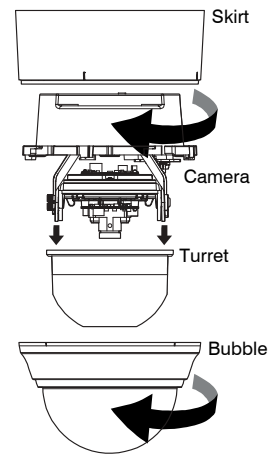

Preparing the Mounting Surface

1. Mark the mounting surface for screw holes and wire access hole.
 - Use the mounting template if you are surface mounting your camera. See [Mounting Template](#) on page 65
 - Use the flush mount adapter plate as a template if you are flush mounting your camera.

Figure 2-2 Mounting Template

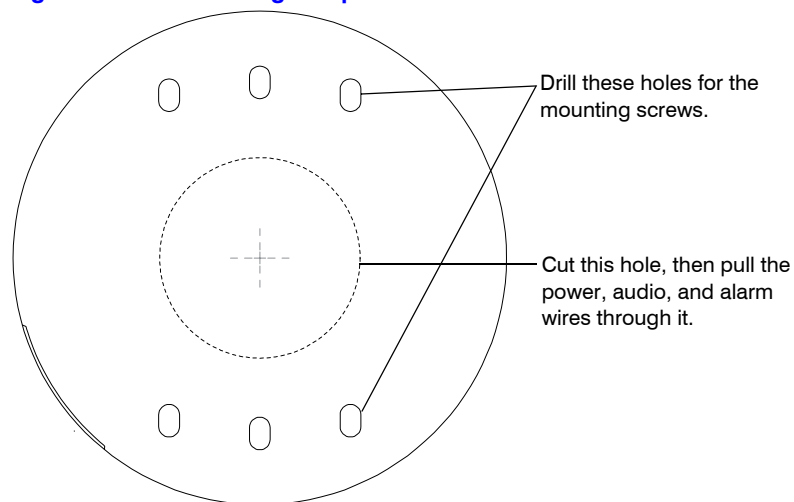

- Pre-drill the holes as indicated on the template, using the recommended hole size for the screws being used.

Note Other fasteners (preferably stainless steel) can be used, provided they are not larger than the screw holes on the mounting template.

Connecting the Wires

Connecting Audio and Alarms

- Pull the wires through the ceiling or wall hole until you have at least 4 inches of wire.
- Remove the green connector strip (see [Figure 2-6](#) on [page 22](#)) from the camera base and make all the necessary alarm and audio connections.
- Connect a twisted pair (UTP) cable from each peripheral alarm contact to each alarm input on the terminal block.

Figure 2-3 Audio and Alarm PINs

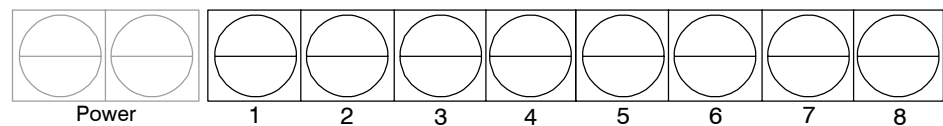

Table 2-1 Audio and Alarm Connector PIN Definitions

PIN	Definition
1	Audio In +
2	Audio In -
3	Audio Out +
4	Audio Out -
5	Alarm In +
6	Alarm In -
7	Alarm Out +
8	Alarm Out -

Connecting Audio

The network camera supports bi-directional audio. There are two supported voice band channels that function in full duplex mode. The camera can transmit audio from the camera to the client (PC) using any audio source that provides an industry standard line level input (see the terminal strip as depicted in [Figure 2-6](#)). The camera can also receive audio from

the client (PC) and provide an industry standard line level output suitable to connect to audio devices. Audio input and output have 600 Ohm impedance. See [Audio Settings](#) on page 63 to configure audio options.

Connecting Alarms

WARNING! Do not exceed the maximum rating of 12 VDC, 0.5 A on alarm output connections.

The HD3MDIP/X network camera has one alarm input and one alarm output. Connect mechanical or electrical switches to the alarm input connection to allow event-triggered recording. When alarm inputs are configured, the HD3MDIP/X triggers an alarm only when the normal alarm state (open or closed) changes.

Figure 2-4 Normal Alarm States

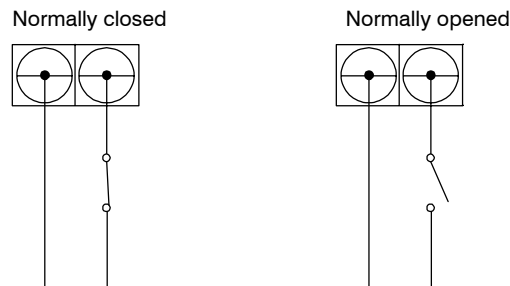

See [Alarm Settings](#) on page 62 to configure the alarm inputs.

Connect external devices such as sirens or flashing lights to the alarm output connector to signal an activated alarm to camera users.

Figure 2-5 Alarm Connection

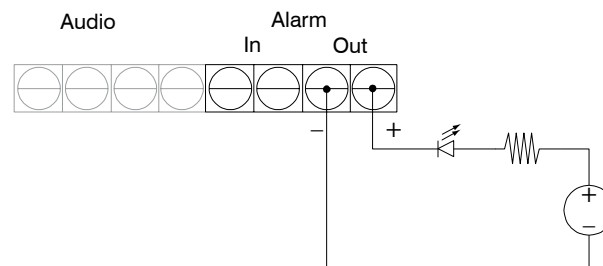

The alarm output can be configured to provide normally open or normally closed contacts (see [Alarm Settings](#) on page 62 to configure the alarm output). Contacts will be rated for 12 VDC @ 0.5 A.

4. Pull the cables through the back or side entries of the camera skirt, then connect the green connector strip to the camera assembly. You might have to remove the cover plate for flush mount.

Connecting Power

WARNING! The use of a CSA Certified/UL Listed Class 2 power supply is required to ensure compliance with electrical safety standards.

Note Check the power source from the external power supply before applying power to the camera.

1. Connect the appropriate power supply for your installation:
 - 24 VAC power supply (proceed to [step 2](#))
or
 - Power over Ethernet (IEEE 802.3af) 48 VDC power supply
-

Note If you are using PoE (802.3af), power will automatically be supplied to the camera through the network cable.

2. Connect to the power supply (see [Figure 2-6](#) on [page 22](#)).
 3. Plug the power supply into an appropriate power source. The LED on the RJ45 jack illuminates when the camera receives power. If it does not illuminate, check the terminal block connections and the power source.
-

Note To ensure satisfactory performance, it is recommended that you use a UPS source when connecting the camera to a 24 VAC power source.

Figure 2-6 Camera and Cables

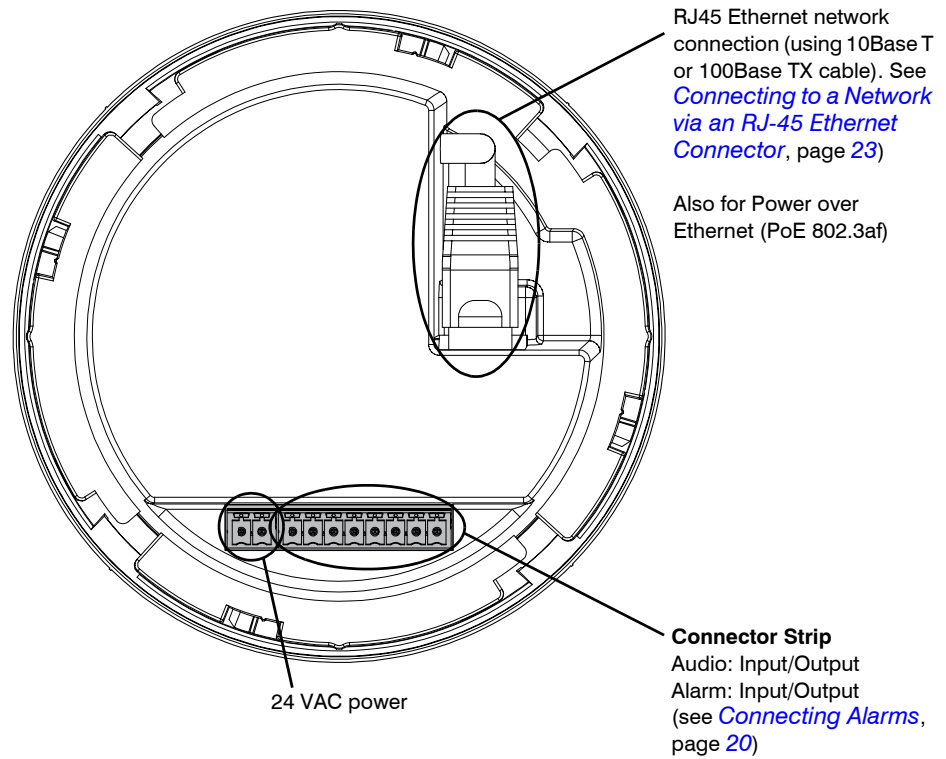
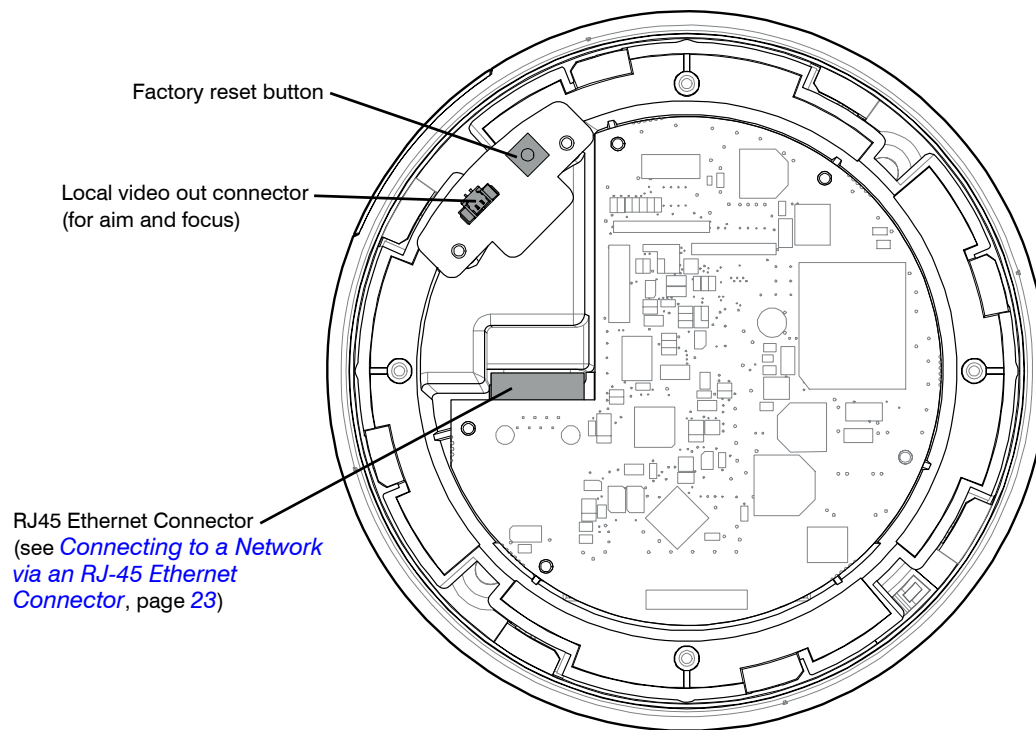

Figure 2-7 Wiring Connection Shown on Board



Caution Installation must be performed by a qualified electrician. The power wire size for the distance and the number of cameras must be determined to maintain 24 VAC at each camera.

Connecting to a Video Monitor

The local video out (see *Figure 2-7*) is available as a test output and should be used as needed during installation to position, aim, and focus the camera. Use the provided BNC connector to connect the video from the camera to the video input connector on your video monitor.

Connecting to a Network via an RJ-45 Ethernet Connector

The main video connection for your network camera will be made through your Ethernet network connection. Connect the **Ethernet** connector on your camera to your network using an Ethernet (10Base-T, 100Base-TX) cable.

Note You can connect your camera to a network or use any type of CAT5 cable to connect it directly to a PC or laptop.

Mounting the Camera

Surface Mount

1. Secure the skirt to the ceiling or wall using the appropriate screws (supplied).
2. Connect the wires (see [Connecting the Wires](#) on page 19).
3. Rotate and align the camera assembly yellow label with the skirt yellow label.
4. Secure the camera assembly to the skirt by pushing it into the skirt, then twisting it clockwise until it clicks securely in place.
5. Secure the camera assembly to the skirt by twisting it clockwise until it clicks securely in place.
6. Adjust the camera's field of view (see [Adjusting the Camera FOV \(Field of View\)](#) on page 25).
7. Install the turret by clicking it into place.
8. Install the bubble by placing it on the camera with the tabs to the left of the slots, then turning it clockwise until the tabs click securely into place.

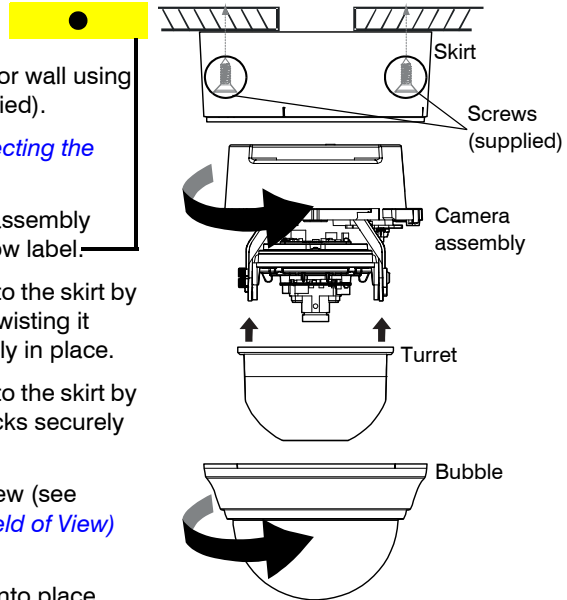

Flush Mount (with or without 4S box)

1. Use the screws (supplied) to connect the adapter plate directly to the ceiling or wall.
Or
Use your own screws to connect the adapter plate to the 4S box (not supplied) which is attached to the ceiling or wall.
2. Connect the wires (see [Connecting the Wires](#) on page 19).
3. Secure the camera assembly to the adapter plate by twisting clockwise until it clicks securely in place.
4. Adjust the camera's field of view (see [Adjusting the Camera FOV \(Field of View\)](#) on page 25).
5. Install the turret by clicking it into place.
6. Install the bubble by placing it on the camera with the tabs to the left of the slots, then turning it clockwise until the tabs click securely into place.

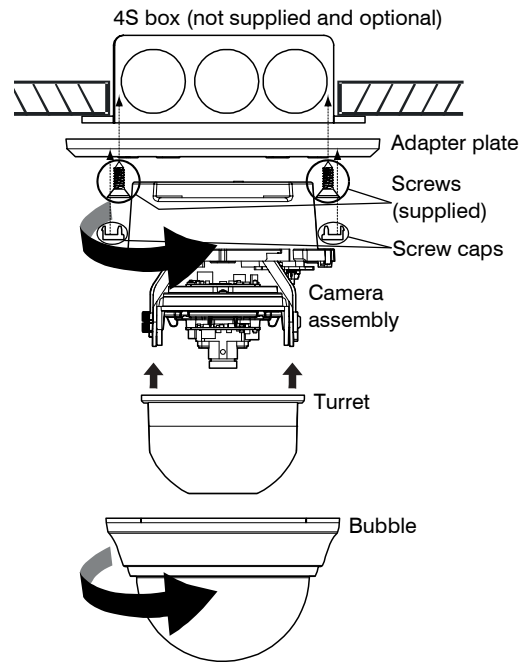

Note Installation with 4S box shown

Restore Factory Defaults

Your network camera has a Factory Reset switch located inside the camera (see [Figure 2-6](#) on [page 22](#)). This switch restores your camera settings and passwords to their default settings. Press and hold the Reset switch for three seconds. This will reset the factory-configured parameters such as the compression settings, the camera tamper detection settings, and the Video Motion Detection settings. It will not impact network IP address configurations.

Adjusting the Camera FOV (Field of View)

To adjust the HD3MDIP/X camera:

1. Apply power to the camera and watch the video on a connected local video monitor (see [Figure 2-7](#) on [page 22](#) to connect a local video monitor).
2. Loosen the setscrew that locks the gimbal assembly in place (see [Figure 2-8](#)) to adjust the horizontal rotation.

3. Adjust the gimbal assembly to the desired view.
4. Re-tighten the locking screw to lock the gimbal assembly in place.

Note Orient the camera as shown in *Figure 2-8* to maintain the correct picture orientation.

Figure 2-8 Gimbal Adjustment

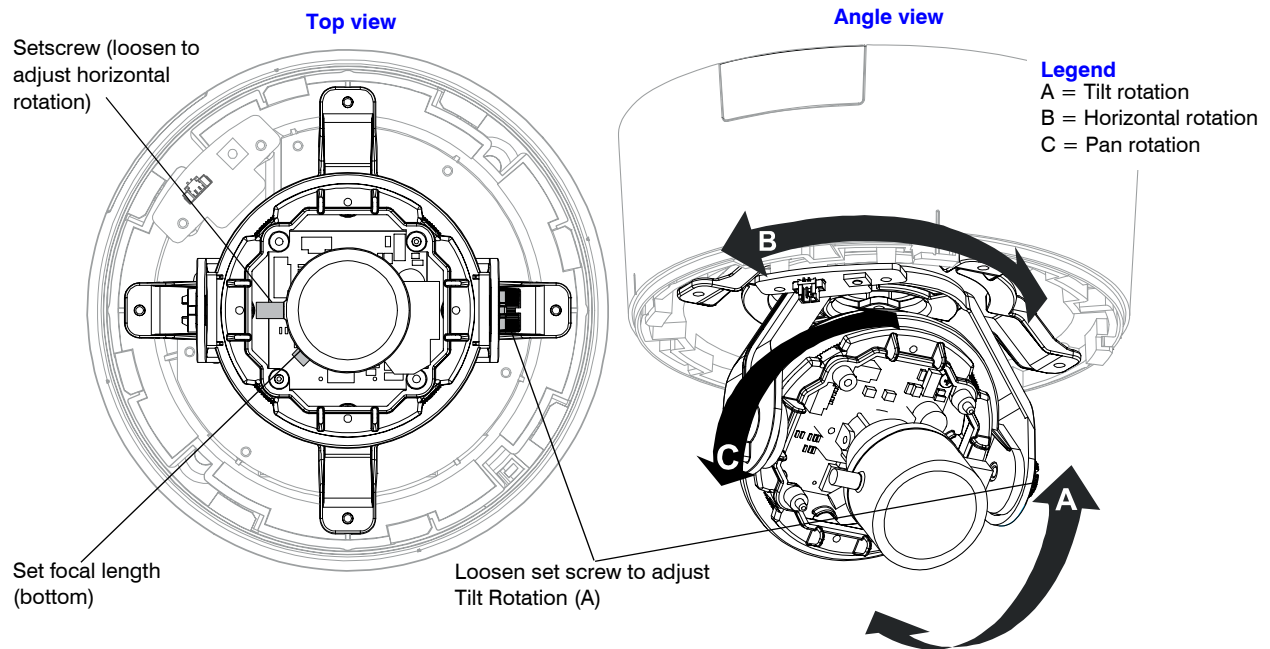

Adjusting the Lens Focus

Lenses are pre-focused at the factory. They might require a final adjustment after installation because the optical effect of the bubble might cause a slight defocusing of the lens.

TECH TIP! To check the focus, hold the bubble over the lens while making any adjustments.

To adjust the camera direction, view angle, and focus, connect the local video out to the video monitor using the supplied BNC video cable.

Securing the Enclosure Cover

Install the bubble when you have set up your camera and completed the network connections (see *Chapter 3, Installing the Honeywell IP Utility and HD3MDIP/X Web-Client Software*).

Place the enclosure cover on the camera with the tabs to the left of the slots, then turn it clockwise until the tabs click securely into place.

Figure 2-9 Installing the Enclosure Cover

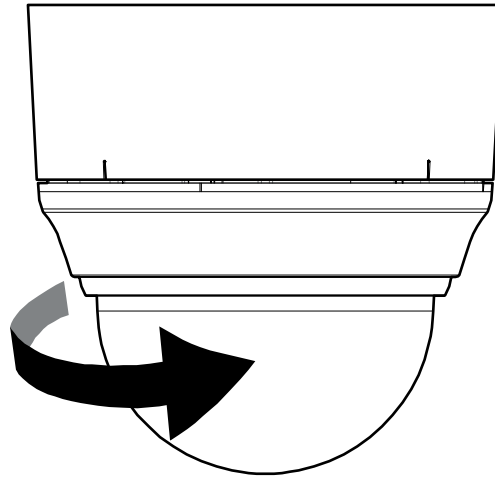

Installing the Honeywell IP Utility and HD3MDIP/X Web-Client Software

This chapter describes how to:

- Install and log onto the IP Utility
- Connect to a device and configure network settings using the IP Utility
- Launch the Web-Client software
- Uninstall the IP Utility, Bonjour, or ActiveX software

About the Honeywell IP Utility and Web-Client

About the Honeywell IP Utility

The Honeywell IP Utility is a software application that is installed from a CD or downloaded from the Honeywell Systems Group website (www.honeywellvideo.com). It is installed on a local workstation and primarily used by Administrators to configure the EQUIP Series of products residing on an IP network.

The IP Utility enables users to:

- Discover device(s) on a network
- Configure the IP network settings, name device(s), upgrade firmware, change passwords.
- Open individual Web-Client applications for each discovered device.

Note Before installing and using the Honeywell IP Utility, confirm that your HD3MDIP/X Network Camera is connected to the network through an Ethernet cable (see [Connecting to a Network via an RJ-45 Ethernet Connector](#) on page 23).

About the Web-Client

The Web-Client is the web-based application that enables users to:

- View live-streaming video.
- View the device network settings and firmware details.
- Configure camera settings
- Configure video analytics settings.
- Configure compression settings.
- Configure alarm and audio settings.

User Profiles: Honeywell IP Utility and Web-Client

Both the Honeywell IP Utility and the Web-Client have two user types: *Administrator* and *Guest* as described in [Table 3-1](#).

Note Only one Administrator and only one Guest can be logged on at a time.

After the IP Utility software is installed, you can change the Administrator or Guest passwords.

Table 3-1 User Profiles for Honeywell IP Utility and the Web-Client

Interface	Administrator	Guest
Honeywell IP Utility	<ul style="list-style-type: none">• View the list of available network devices and connect to the devices.• Configure the IP network settings.• Upgrade firmware.• Change the password to access the IP Utility application.• Change the access passwords to the Web-Client application.	<ul style="list-style-type: none">• View the list of devices available on the network.• View system settings including device name, IP address, and MAC address.
Web-Client	<ul style="list-style-type: none">• View video and network settings.• Configure compression settings.• Configure camera setup.• Configure video analytics.• Configure audio and alarms.	<ul style="list-style-type: none">• Guest users are limited to the Live View tab where they can view video

Step 1: Confirm Your System Requirements

Note Windows administrator privileges are required to install the Honeywell IP Utility and associated software.

Note Contact the network administrator if there are any questions regarding the local area network (LAN) or any other network related issues.

Install the Honeywell IP Utility on a work station with the minimum requirements (outlined in [Table 3-2](#)). After the IP Utility is installed, the same computer workstation can be used to access the Web-Client.

Table 3-2 PC Minimum System Requirements

Component	Requirement
Operating System	Windows XP® or WINServer 2003
Processor	Intel® Pentium® IV, 3.1 GHz or faster
RAM	1 GB RAM or higher

Table 3-3 Items Installed On Your System

Item	Function
Honeywell IP Utility software	To enable use of the Web-Client to configure cameras and view live video.
Bonjour software	To enable the devices to discover cameras on the network.
HD3MDIP/X Honeywell IP Adapter software	Required if a workstation does not have IP Utility installed but an operator is using the Web-Client.
HD3MDIP/X Honeywell ActiveX software	To enable live streaming of video on the Web-Client.
EQUIP™ Series User Guides	To provide detailed information about how to install and configure your EQUIP Series products.

Step 2: Install the Honeywell IP Utility Software

1. Close all other applications that might be open on your computer.
2. Open the **Honeywell IP Utility InstallShield Wizard**.

Method 1: CD

Insert the CD into the CD-ROM drive.

Note If InstallShield does not open automatically, navigate to [**CD drive**]\Honeywell IP Utility\Honeywell IP Utility Setup.exe. Double-click on the file to launch the program.

Method 2: Website

- a. Navigate to **www.honeywellvideo.com**.
 - b. Click **Customer Resources** ► **Download Center** ► **I Agree** to reach the software downloads page.
 - c. Locate your device in the list (for example, click **Cameras** for HD3MDIP/X IP devices).
 - d. Under Honeywell IP Utility, download, extract and open the **Honeywell IP Utility Set-up.exe** icon from where you extracted the file.
3. When the **Honeywell IP Utility InstallShield Wizard** opens, follow the instructions. After the installation is complete, a **Honeywell IP Utility** icon  displays on the desktop.

Downloading the EQUIP Series Installation Guides

1. To access the installation documents that were installed with the IP Utility, click **Start** ► **All Programs** ► **Honeywell Video Systems** ► **EQUIP Series** ► **Manuals** ►
2. Select the applicable PDF to download to your computer.

Figure 3-1 Accessing Your Installation Documents

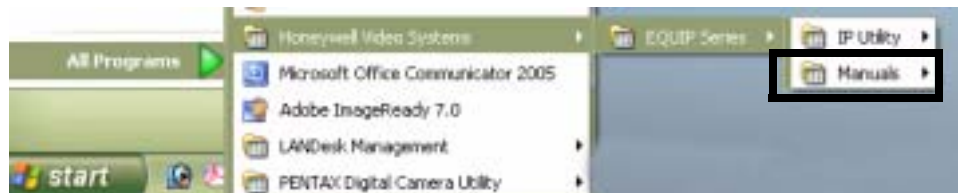

Step 3: Log Onto the IP Utility and Discover Network Devices

1. Double-click the **Honeywell IP Utility** icon  on your desktop.
-OR-
Click **Start > Programs > Honeywell Video Systems > EQUIP Series > IP Utility > Honeywell IP Utility**.
The **Honeywell IP Utility Log On** window opens.

Figure 3-2 Honeywell IP Utility Log On Window



2. Select **Administrator** or **Guest** from the **User Name** drop-down list.
3. Enter the case-sensitive password in the **Password** field.
 - The default Administrator password is **1234**.
Only one Administrator can be logged on at a time.
 - The default Guest password is **guest**.

Note During the installation set up, you must log on as an Administrator to access all the features.





4. Click the arrow button .
The **Honeywell IP Utility** program searches for devices on the network and opens to the Honeywell IP Utility user interface.
5. Automatically discover or manually refresh the list of devices on the network. Use the manual refresh if a new device was added after you logged onto the system.
 - You do not need to do anything to discover devices. When you log on to the IP Utility, the devices on the network — including the devices on other subnets — are automatically discovered and listed in the Discovery pane. After the initial discovery, the network automatically continues to discover devices that are newly added to the network.
 - To manually refresh the device list, click the **Refresh** () button, located near the top of the Discovery pane.
6. **Enable or disable the HTTP Server checkbox** for additional security. Only an Administrator can disable (uncheck the box), resulting in the user being unable to access the Web-Client, although video recording is unaffected.

Figure 3-3 Honeywell IP Utility User Interface

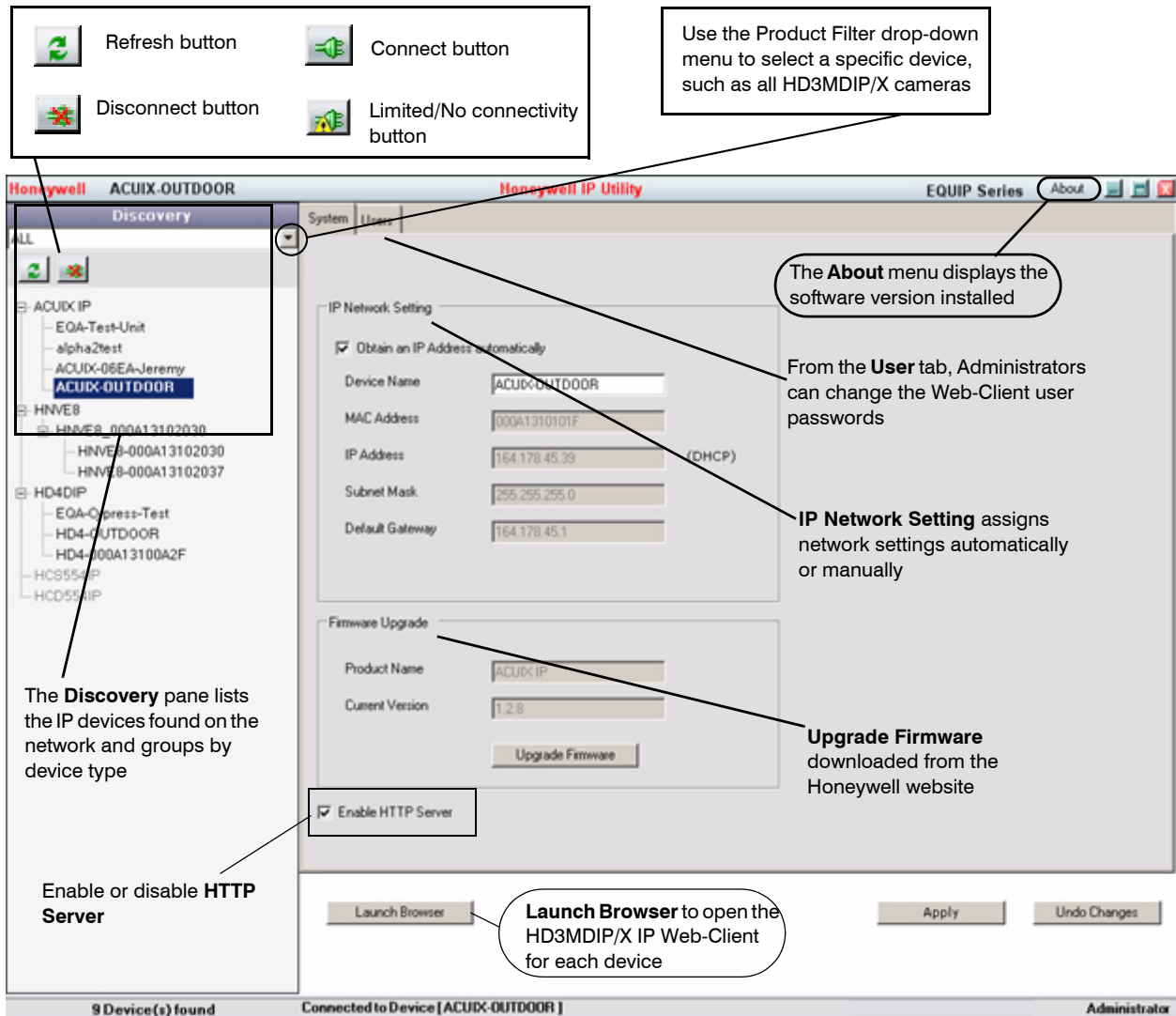

Step 4: Connect to a Device and Configure Network Settings

When you log on to the IP Utility, the devices on the network—including the devices on other subnets—are automatically discovered and are listed in the **Discovery** pane. After the initial discovery, auto-refresh continues to discover devices that are newly added to the network.

You can also manually refresh the device discovery by clicking the **Discovery** icon (), located near the top of the Discovery pane.

Connecting to or Disconnecting From Devices

Before configuring the IP network settings, you must connect to the IP device.

Connecting to a Device

You can connect to individual Web-Client applications for each discovered device.

- In the **Discovery** pane, double-click the device to which you want to connect.
- OR-
- Select the device and click the **Connect**  button.
The network settings for the connected device are displayed in the **System** pane.

Disconnecting from a Device

In the **Discovery** pane, select the device and click **Disconnect** .

Note If you disconnect the device without saving configuration details, a warning dialog box displays. Click **Yes** to save and disconnect, or click **Cancel** to discard the changes and disconnect the device.

Configuring the IP Network Settings Automatically or Manually

Note When you see the **Limited/No connectivity**  button, you cannot fully connect to the device because the discovered device is on a different subnet from your PC. Check your network settings for both the device and your PC to resolve this issue. Consult your network administrator for additional support.

The IP network setting details, such as device name, IP address, and subnet mask can be configured for each connected device either automatically or manually.

Note It is important to click **Apply** to save any configuration change.

Table 3-4 IP Network Device Setting Options

Option	Description
Device Name	By default, the device name is the device type plus the MAC Address. Honeywell recommends, for security, that you change the device name.
IP Address	The IP address of the device on the network. The camera obtains an IP address by static or dynamic (automatic) means. There are two options: DHCP (dynamic), assigned by the user, or APIPA (static), assigned by the network.
Subnet Mask	The subnet mask, or netmask, value of the device on the network. IP networks can be divided into several smaller networks by subnetting. When a network is subnetted, you must specify a subnet mask, which tells network devices which smaller network they belong to. <p>Note If the subnet mask is not properly configured, the camera might not be able to communicate with other devices on the network.</p>
Default Gateway	The default gateway address that connects the device to the network. Enter the IP address of the host to use as a gateway between networks. The gateway allows communication between devices that are on different networks. Without a correct gateway setting, the camera cannot receive or transmit data from or to devices that are not in the same network address range.
MAC Address	The MAC address is a factory-assigned address that is unique for each device.

Figure 3-4 Set the IP Network Settings Automatically or Manually

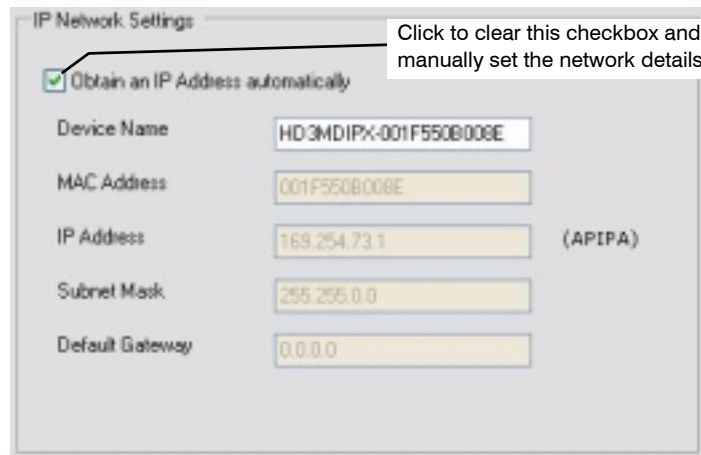

Updating IP Network Settings Automatically

1. In the **Discovery** pane, select the device and click **Connect** .
2. From the **System** tab click the **Obtain an IP Address automatically** check box.
3. Enter a **Device Name**, for example, *FrontLobbyDome01*.
4. Click **Apply**.
The network automatically assigns the IP Address based on the DHCP network server details. **If no DHCP server is present on the network, the hardware defaults to an APIPA address (169.254.x.x).**

Updating IP Network Settings Manually



Caution When manually updating the network settings, it is important to enter the correct IP network settings before applying them. Incorrect values might cause a failure when connecting to the device. See [Table 3-4](#) for definitions of each setting.

1. In the **Discovery** pane, select the device, and click **Connect** .
2. To assign a static IP address to the device, from the **System** tab click to clear the **Obtain an IP Address automatically** check box.
3. Enter a **Device Name**, for example, *FrontLobby01*.

Note The MAC address is a factory assigned address that is unique for each device.

4. Enter an **IP Address** of the device on the network.

Note The address must be in the same address range. For example, if the PC is 192.188.1.xx, then the device should be set to a similar address, for example 192.168.1.xy.

5. Enter the device **Subnet Mask** value. A value is required.
6. Enter a default **Gateway Address** that connects the device to the static network. A value is required.
7. Click **Apply**.
The network settings are updated and a message displays in the status bar to confirm the update.

Interfacing with the EQUIP Device Via a Network Video Recorder

Your recording vendor has the option of using either the connection methods supported by EQUIP V1 firmware or EQUIP V2.1 firmware. If the NVR vendor has implemented EQUIP V1 connection methods, the HD3MDIP/X camera will work on those NVRs. Similarly, if the NVR vendor has implemented EQUIP V2.1 connection methods, the HD3MDIP/X camera will work on those NVRs. There is no user configuration necessary.

For further information, refer to the documentation supplied with your NVR or contact your NVR network administrator.

Step 5: Launch the Web-Client to View Live Video

Note Only one Administrator and one Guest can log on to the Web-Client application at one time. After you are logged in as an Administrator, there is no time out until you click **Logout**. To allow other Administrators to log on, you must log out when the session is done.

Note After the IP Utility software is installed for the first time, you can change the Administrator or Guest passwords and upgrade firmware.

Note It is important to click **Apply** in order to save any configuration change.

1. Log onto the Web-Client. There are two ways to launch the Web-Client and log on—via the Honeywell IP Utility Program or directly from Internet Explorer.

Honeywell IP Utility

- a. Log onto the Honeywell IP Utility program.
- b. From the **Discovery** pane, click to select the device to launch its browser.
- c. To enable or disable the HTTP server, select or clear the **Enable HTTP Server** check box. By default, the HTTP server is enabled.
- d. From the **System** tab, click **Launch Browser**.
The Web-Client application for the selected device opens in Internet Explorer.

Internet Explorer

From Internet Explorer (v6.0+), **enter the URL** (IP address of the device) in the Address bar to open the logon window.

2. Select a **User Name** and enter a **Password**.
 - a. From the **User Name** drop-down list, select **Administrator** or **Guest**.
 - b. In the **Password** field, enter the case-sensitive password.
 - The default Administrator password is **1234**.
 - The default Guest password is **guest**.
 - c. Click .
3. A signed version of ActiveX® control is installed when you use the Web-Client to discover connected devices for the first time. If you have a previous version of IP ActiveX is installed, you are prompted to upgrade to Honeywell secure ActiveX control.

Figure 3-5 ActiveX Prompt



Click **Yes**.

4. Follow the InstallShield Wizard prompts to install the secure Honeywell IP ActiveX on your PC.
5. The InstallShield Wizard Completed message indicates a successful ActiveX upgrade. Click **Finish**.

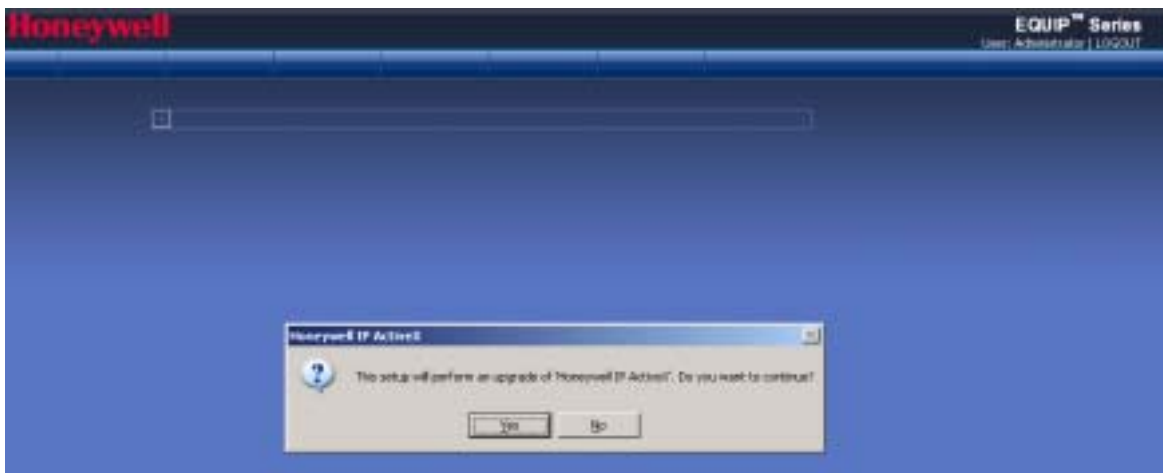
The Web-Client interface opens and live streaming video displays on the monitor.

Figure 3-6 Web-Client Interface After Logging On

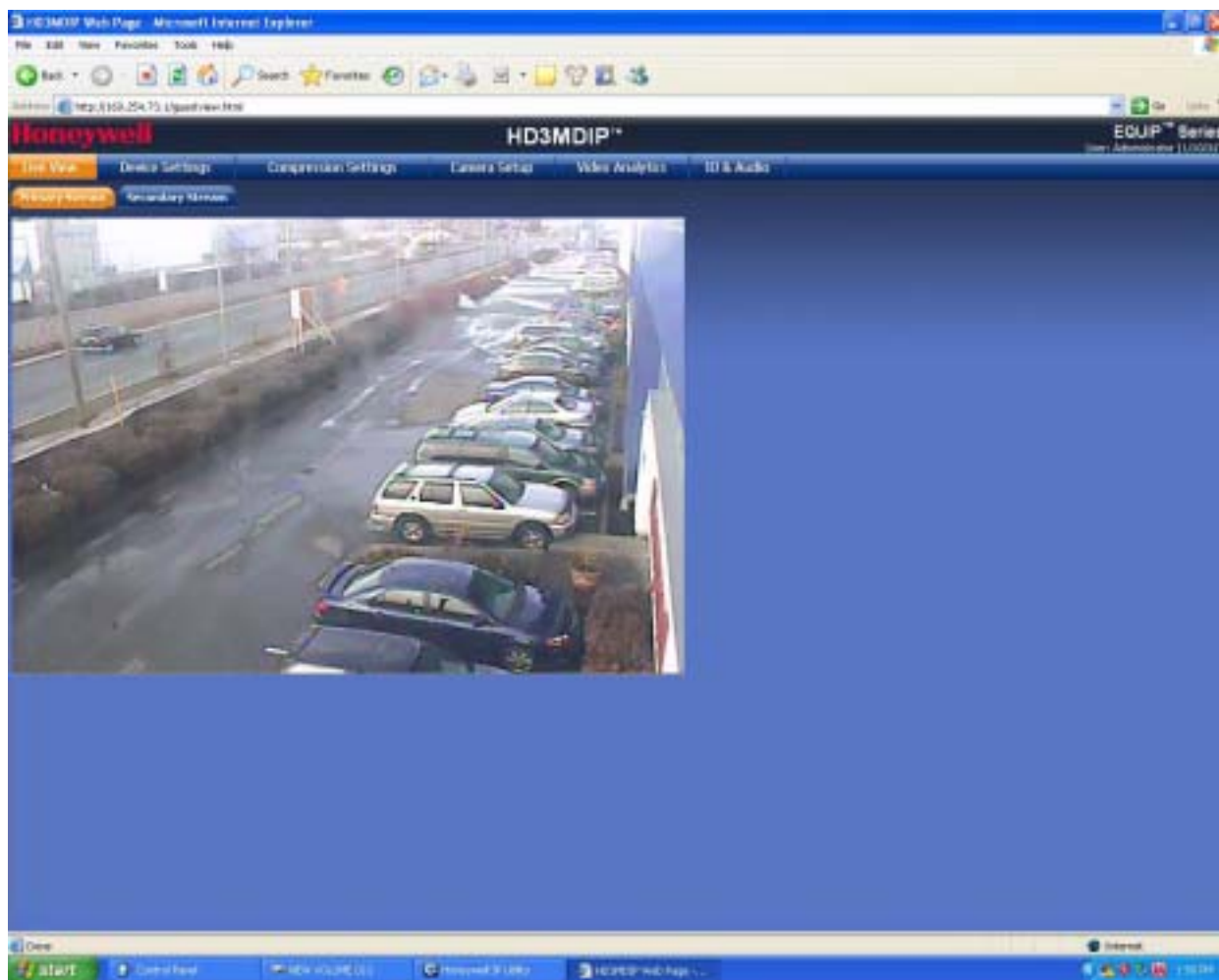

Uninstalling IP Utility, Bonjour or the ActiveX Plug-in Software

You can uninstall the IP Utility, Bonjour, or IP ActiveX software using:

- The **Start** menu to uninstall IP Utility and Bonjour
- OR
- The **Control Panel** to uninstall IP Utility, Bonjour and IP ActiveX.

Uninstalling IP Utility Using the Start Menu

1. Click **Start** ► **All Programs** ► **Honeywell Video Systems** ► **EQUIP Series** ► **IP Utility** ► **Uninstall Honeywell IP Utility**.
2. Click **Yes**.
The Honeywell IP Utility is uninstalled.
3. During the uninstallation process, you are prompted to also uninstall the Bonjour program. Click **Yes** to remove Bonjour or **No** to only uninstall the Honeywell IP Utility.
4. Click **Finish**.

Uninstalling IP Utility or IP ActiveX Using the Control Panel

1. Click **Start** ► **Settings** ► **Control Panel**.
2. Open **Add or Remove Programs** and select **Honeywell IP Utility** or **Honeywell IP ActiveX** from the **Currently installed** programs list.
3. Click **Change/Remove**.
The **IP Utility Installation Wizard** screen opens.
4. Click **Next** ► **Remove**.
The Honeywell IP Utility is uninstalled.
5. During the uninstallation process, you are prompted to also uninstall the Bonjour program. Click **Yes** to remove Bonjour or **No** to only uninstall the Honeywell IP Utility.
6. Click **Finish**.

IP Camera Web-Client

Before you launch the Honeywell IP Web-Client, ensure that you complete the following sections before configuring your HD3MDIP/X camera:

- [Chapter 2, Installation and Setup](#)
- [Chapter 3, Installing the Honeywell IP Utility and HD3MDIP/X Web-Client Software](#)

This chapter covers:

- Navigating the Web-Client interface
- Understanding the Web-Client features and functions
- Configuring compression settings
- Configuring camera settings
- Setting tamper detection
- Configuring audio and alarm settings

Overview

The network camera Web-Client is a web-based application that enables you to view video, listen to audio, and configure camera, sabotage detection, motion detection, alarm, and audio settings for the network camera.

Certain features of the IP Camera Web-Client are user-based and are available only to the Administrator. The guest user is limited to the Live View tab. Only one Administrator and one Guest can be logged on at a time.

User Profiles

Table 4-1 describes the roles and privileges for the HD3MDIP/X Web-Client application users:

Table 4-1 User Roles and Privileges

User Role	Privileges
Administrator	<ul style="list-style-type: none"> View video and network settings Configure the alarm and audio settings Set up the video compression settings Configure auto exposure and white balance for the camera Set up camera sabotage and video motion detection settings
Note Only 1 Administrator can be logged on at a time	
Guest Operator	<ul style="list-style-type: none"> View video
Only 1 Guest can be logged on at a time	

Logging On and Off the HD3MDIP/X IP Web-Client

Note One *Administrator* and one *Guest* can log on to the Web-Client application at a time.

There are two ways to open each HD3MDIP/X IP Web-Client.

- By clicking **Launch Browser** from the IP Utility interface.
- Directly from Internet Explorer by entering the URL (the IP address) in the address bar.

Note The web page where you log on to the Honeywell IP Utility and any IP device web page (for example, the HD3MDIP/X IP Web-Client) look very similar. You can tell the difference between the two sites by the IP address in the web browser as well as the program name in the lower left corner of the window.

Launching the Web-Client from IP Utility

- From the desktop, double-click the **Honeywell IP Utility** icon .

-OR-



 Click **Start > All Programs > Honeywell Video Systems > EQUIP Series > IP Utility > Honeywell IP Utility**.
 The **Honeywell IP Utility Log On** window opens.
- From the **User Name** drop-down list, select **Administrator** or **Guest**.
 See [Table 4-1](#) on [page 44](#) for User roles and privileges.
- In the **Password** field, enter the case-sensitive password.
 - The default Administrator password is **1234**.
 Only one Administrator can be logged in at a time.
 - The default Guest password is **guest**.
- Click .
 The **Honeywell IP Utility** program searches for devices on the network and opens to the Honeywell IP Utility user interface.
- In the **Discovery** pane, double-click the device you want to connect to.
 -OR-
 Select the device and click **Connect** .
 The network settings for the connected device are displayed in the **System** pane.
- Click **Launch Browser** (see [Figure 4-1](#)) to go to the HD3MDIP/X Web-Client logon page.

Figure 4-1 Launching the HD3MDIP/X Web-Client from IP Utility



Logging Onto the Web-Client from Internet Explorer

1. From Internet Explorer (v6.0+), enter the URL (IP address of the device) in the Address bar to open the logon window.
The **Web-Client** log on page opens.

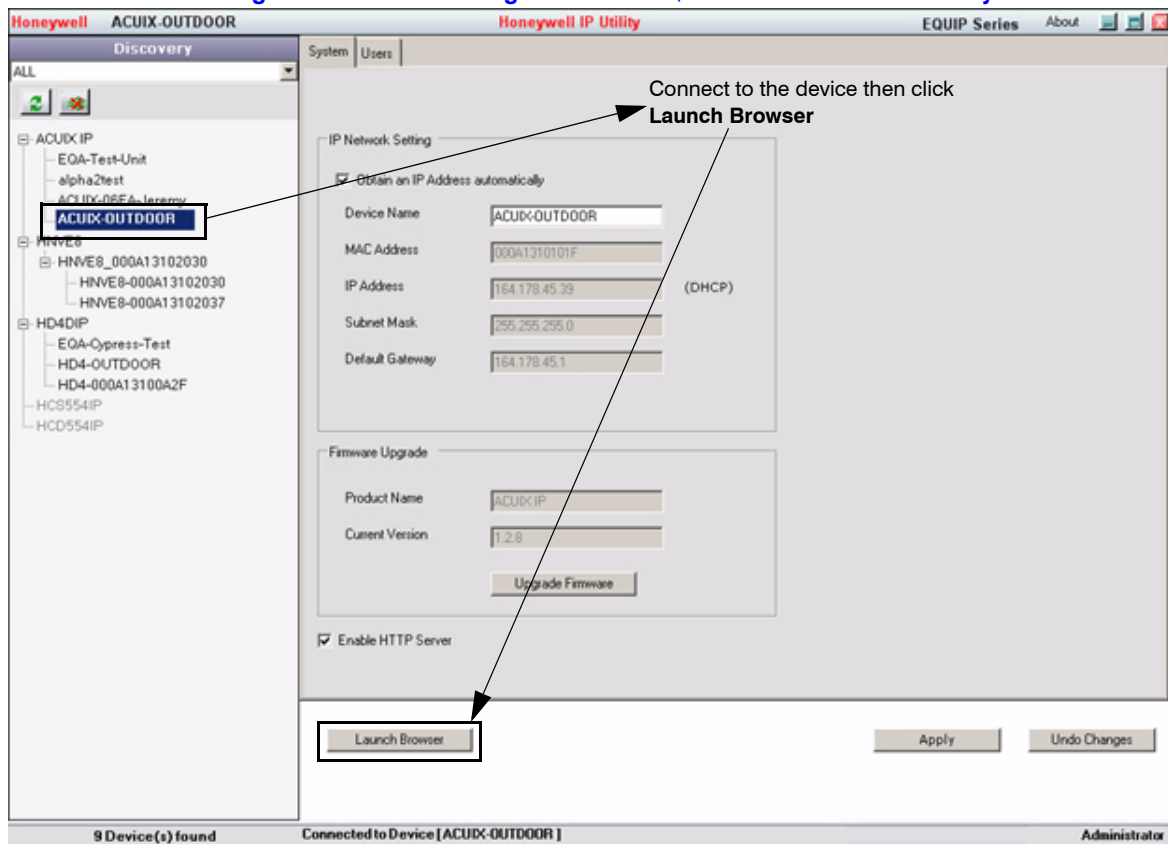

2. Select a **User Name** and enter a **Password**.
 - a. From the **User Name** drop-down list, select **Administrator** or **Guest**.
 - b. In the **Password** field, enter the case-sensitive password.
 - The default Administrator password is **1234**.
 - The default Guest password is **guest**.
 - c. Click .
3. The Web-Client interface opens and live streaming video displays on the monitor.

Logging Out of the Web-Client

Note After you are logged onto the HD3MDIP/X Web-Client there is no time out until you click **Logout**. To allow other Administrators to log on, you must log out when the session is done.

To log out from the Web-Client application, click **Logout** at the top of the Web-Client window.

Note Do not use the **CLOSE** button () in Internet Explorer to logout or the session might not end correctly, and settings that have you changed might not be saved.

Navigating the User Interface

Figure 4-2 Web-Client Window Layout: Administrator Log On

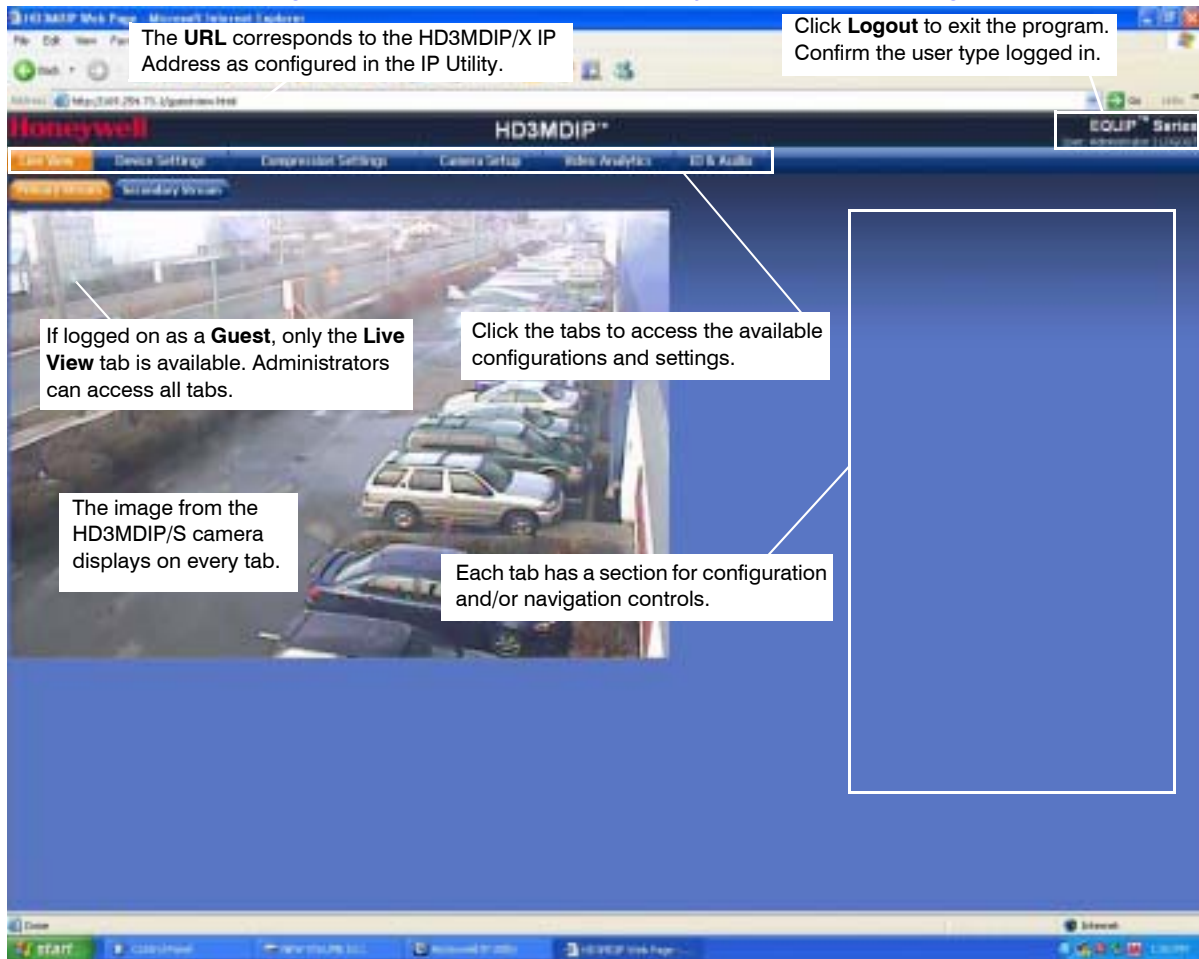

The HD3MDIP/X Web-Client application user interface consists of multiple user-friendly views organized by function. Access to the views is user-controlled.

Table 4-2 Tabs/Views in the Web-Client Application

Tab	Enables you to...
Live View	View video.
Device Information	View the network settings and firmware details of the camera.
Compression Settings	Configure the compression. Set the maximum bit rate and/or target bit rate that the camera will provide across the network based on priority mode settings. This value is the threshold that you do not want the bit rate to exceed. View received bit rate and frame rate statistics of the current image in real time.
Camera Setup	Configure auto exposure and white balance for the camera.
Video Analytics	Configure the camera sabotage detection settings and view video display.
Alarm and Audio	Configure the alarm and audio settings.

Figure 4-3 Web-Client: Administrator User

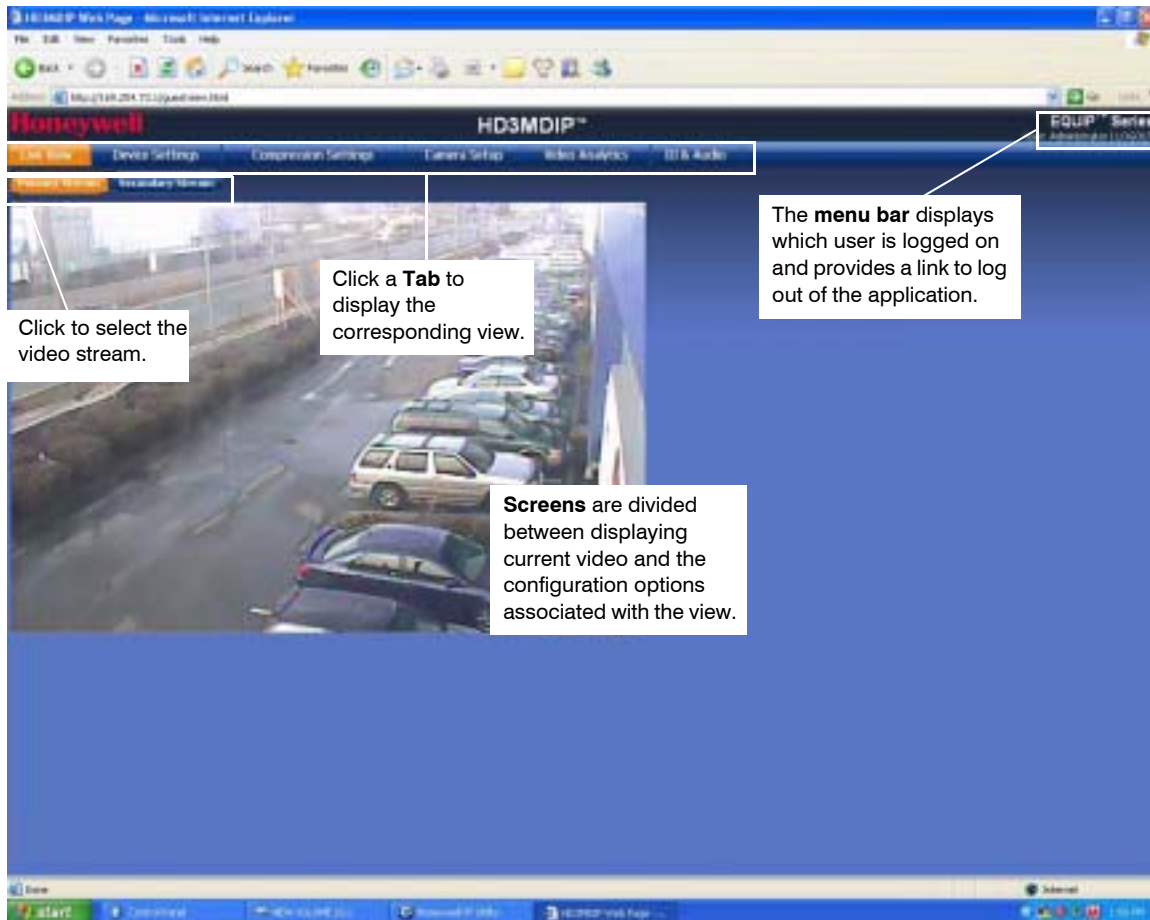
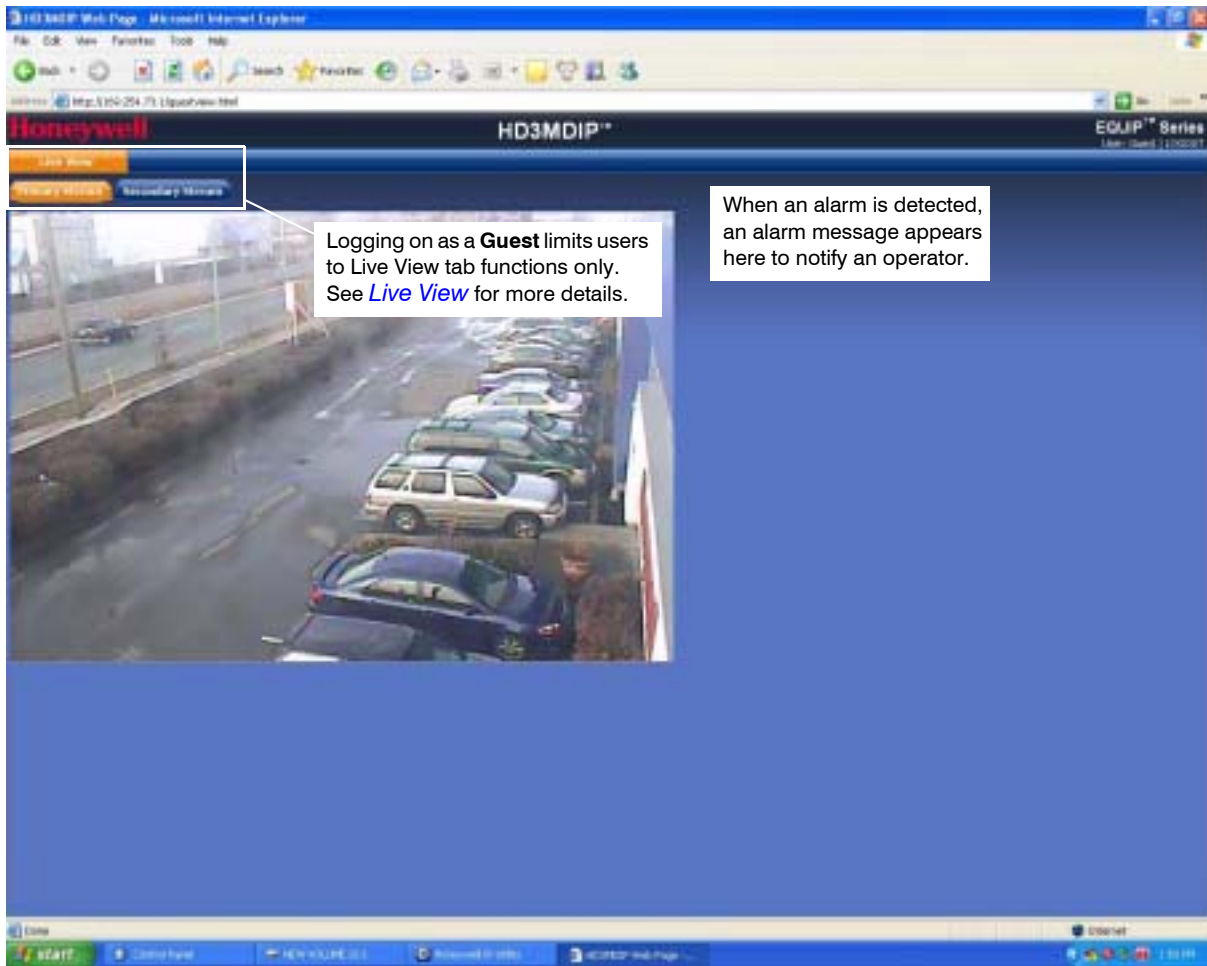

Figure 4-4 Web-Client: Guest User



Live View

Live View shows live video from the selected camera (see [Figure 4-4](#)).

Device Settings

The Device Settings tab allows you to view the network settings and firmware details of the camera.

IP and Firmware Settings on the Device Information Tab

Depending on the hardware installation, there is a tab called either **Device Information** or **Device Settings**. In both cases, the IP and Firmware Settings panel mirrors the information available in the Honeywell IP Utility. It provides read-only network settings, firmware settings, and video formats without having to access the IP Utility.

The Device Settings are the same for the Primary and Secondary streams.

Figure 4-5 Device Settings



Figure 4-6 IP and Firmware Settings: Device Information Tab

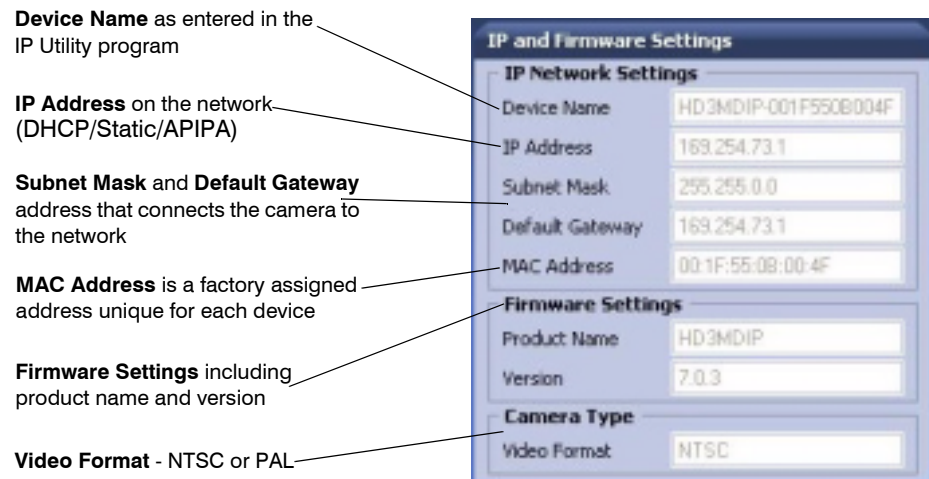

Compression Settings

The video signal sent from the camera to the Web-Client has a number of settings that can be edited which affect how the video displays in the Web-Client. The Compression Settings view enables you to configure these settings:

- Stream Type
- Resolution
- Frame Rate
- Priority (**Quality** or **Bit Rate**)
- Compression Ratio (if **Quality** is chosen as the priority)
- Target Bit Rate (if **Bit Rate** is chosen as the priority)
- Maximum Bit Rate that the camera will provide across the network
- GOP (number of frames)

Figure 4-7 Compressions Settings Tab: Primary Stream



Your HD3MDIP/X camera provides dual simultaneous video streams. Although the Primary stream can support a single MPEG4 SP in real time 30 fps at 720p resolution, it must be set to less than 720P for the second stream to operate. The Secondary stream operates at a lower frame rate than the Primary stream.

Video Codec Settings Tab

Figure 4-8 Video Codec Settings Tab Available Functions

Primary Stream

Video Codec Settings	
Stream Type	MPEG4
Resolution	VGA (640x480)
Frame Rate	30
Priority	Bit Rate
Compression Ratio	N/A
Target Bit Rate (kpbs)	2000
Maximum Bit Rate (kpbs)	N/A
GOP (No. of Frames)	20

Default settings shown

Secondary Stream

Video Codec Settings	
Stream Type	MJPEG
Resolution	QVGA (320x240)
Frame Rate	30
Priority	Bit Rate
Compression Ratio	N/A
Target Bit Rate (kpbs)	2000
Maximum Bit Rate (kpbs)	N/A

Default settings shown

- Set the **Resolution** for NTSC or PAL video signals
- Set the **Frame Rate** (the number of frames displayed on screen per second)
- Set the **Priority** for Quality or Bit Rate
- Set the **Compression Ratio** (when **Quality** is selected)
- Set the **Target Bit Rate** (the amount of data processed per second)
- Set the **Maximum Bit Rate** (kpbs)
- Set the **GOP** (Group of Pictures)

Configuring the Compression Settings

1. On the Compression Settings tab, in the **Statistics** area, select the **Received** check box to receive in real time the bit rate and frame rates for the current image. Deselecting the check box disables the refresh rate.

Note The **Received** check box is disabled by default. When you log out, this check box reverts to the disabled state.

2. Use [Table 4-3](#) to set up the video compression.

Table 4-3 Compression Settings

Setting	Options	Description
Primary Stream Resolution	HD (1280x720) SVGA (800x600) VGA (640x480) QVGA (320x240)	HD is the highest resolution; QVGA is the lowest resolution.
Secondary Stream Resolution	VGA (640x480) QVGA (320x240)	Up to 15 fps supported Up to 20 fps supported
Frame Rate	1–30 (NTSC) 1–25 (PAL)	The frame rate that is displayed per second. For NTSC, select from 1 fps (lowest) to 30 fps (highest). For PAL, select from 1 fps (lowest) to 25 fps (highest).
Priority	Quality, Bit Rate	Allows you to set the maximum bit rate and/or target rate value, based on priority mode settings. This value is the threshold that you do not want the bit rate to exceed.
	Select this Priority field setting	To enable this field ... To achieve this ...
	Quality (see Figure 4-9)	Maximum Bit Rate If the target bit rate exceeds the maximum bit rate value, the camera adjusts the picture quality first and then, if necessary, drops frames to meet the maximum bit rate value.
	Bit Rate (see Figure 4-9)	Target Bit Rate and Maximum Bit Rate The Picture Quality field is grayed out. Set the Maximum Bit Rate—limit the data transfer speed—from 400 ~ 5000 kbps. As the target bit rate exceeds the maximum bit rate value, the camera reduces the bit rate by adjusting the frames dynamically to stay below the threshold that you set.
Compression Ratio	Minimum, Low, Medium, High, Maximum	When Quality is selected as the Priority, select the Compression Ratio. Minimum is the highest visual quality; Maximum is the lowest visual quality.
Target Bit Rate (kbps)	400 – 5000 kbps	Enter the Target Bit Rate in kbps (kilobits per second) which represents the amount of data processed per second.
GOP (No. of Frames)	1– 60	Select the GOP (Group of pictures) number from 1 to 100 . (Not available on the Secondary Stream.)

Figure 4-9 Video Codec Settings, Quality Priority Selected

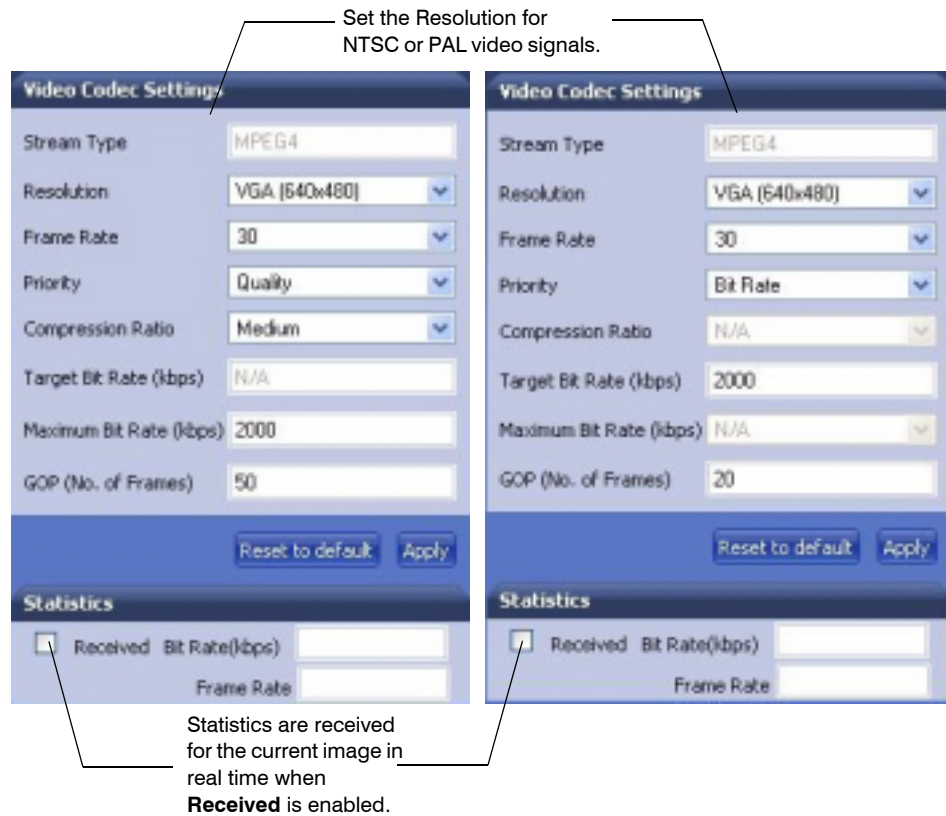

3. Click **Apply**. Adjustments in your compression settings are captured in the statistics. As you make adjustments, the Statistics field acts as a visual reminder of how your settings affect the bit rate, frame rate, and bandwidth usage.
4. When you are satisfied with your settings—that is, that the image quality and bandwidth usage meets your requirements—click **Apply** to save your settings. Settings are not saved unless you click **Apply**.

Statistics: Received Bit Rate and Frame Rate

To view in real time the received bit rate and frame rate statistics of the current image:

1. Click the **Compression Settings** tab.
2. In the **Statistics** area, select the **Received** check box.
Deselecting the check box disables the refresh rate.

Note The Received check box is disabled by default. When you log out, this check box reverts to the disabled state.

Camera Setup

The Camera Setup view provides access to the settings used to configure the camera configurations for both Primary and Secondary streams. The following section explains Auto Exposure and White Balance setup.

Note You must click **Apply** after you make changes to any settings to save those changes. Settings are not saved unless you click **Apply**.

Figure 4-10 Camera Setup



Auto Exposure

The camera lens, lighting, and true day/night options can be configured as needed using the Auto Exposure settings. Use [Table 4-4](#) to set up Auto Exposure options.

Note You must click **Apply** after you make changes to any settings to save those changes. Settings are not saved unless you click **Apply**.

Table 4-4 Auto Exposure Settings

Setting	Options	Description
ALC (Automatic Light Compensation)	DC Iris Level: 1–25	For an automatic iris lens. Adjust the DC Iris Level until the image is neither too bright nor too dark.
AGC (Automatic Gain Control)	Off, 10 dB–40 dB	Adjust the maximum value of AGC gain. AGC can be Off , or set to 20 dB , 30 dB , or 40 dB . Note As AGC levels are reduced, the threshold ranges for DayToNight and NightToDay are decreased.
DNR (Digital Noise Reduction)	Off, On	Improves picture performance in low light by reducing video noise. DNR is deactivated if AGC is turned Off .
Flickerless	Off, On	Eliminates the “flicker” that can appear in an image under certain lighting conditions (for example, fluorescent lighting).
Digital Slow Shutter (DSS)	Off, Low, High	Automatically provides a clear image under low-light conditions (increasing magnification may cause noise/distortion).
Day/Night	Auto, Day, Night	Set the moving mechanical IR filter within the camera to ensure true 24-hour surveillance.
Night Mode	B/W or Color	Sets the color mode as B/W (monochrome) or Color in Night Mode. Day/Night must be set to Night .
Detect Time	5–60 seconds	Sets the time (5–60 seconds) before the camera switches to Day or Night mode after detecting a low-light condition. Day/Night must be set to Auto .
DayToNight	1–7	Determines the low light detection level (1–7) when the camera switches to Night mode. The lower the value, the darker the lighting conditions before the camera switches. Day/Night must be set to Auto . Note The DayToNight threshold level must be set at least 2 less than the NightToDay threshold setting. Note The DayToNight threshold range is decreased if the AGC level is reduced.
NightToDay	3–9	Determines the low light detection level (3–9) when the camera switches to Day mode. The higher the value, the brighter the lighting conditions before the camera switches. Day/Night must be set to Auto . Note The NightToDay threshold range is decreased if the AGC level is reduced.

White Balance

White Balance ensures that color integrity is maintained in the camera image by compensating for the temperature color “casts” that different light sources can cause. Use [Table 4-5](#) to set up White Balance options.

Note You must click **Apply** after you make changes to any settings to save those changes. Settings are not saved unless you click **Apply**.

Table 4-5 White Balance Settings

Option	Description
AWC Auto (Auto White Balance Control Mode)	A faster AWB mode with a wide operating range.
MWB (Manual Mode)	Manual white balance mode. Set the Red and Blue gains from 0–255.
AWC Push (Auto White Balance Control Mode)	Automatically adjust the white balance to your specific environment. When selected, the white balance is locked.

Note This setting is recommended for situations in which the light conditions are constant, so that the specified color temperature does not change.

Video Analytics

The HD3MDIP/X camera can be configured to detect camera sabotage and motion within a scene via the Video Analytics view (see [Figure 4-11](#)). The Video Analytics tab enables a user to set the tamper detection threshold settings for blur, blinding and scene changes.

Figure 4-11 Video Analytics Tab



Each setting has three threshold levels: high (80%), medium (50%) and low (30%). When these thresholds are exceeded, camera sabotage or motion is detected, and alarm messages appear above the video display and alarm signals are sent to DVRs/NVRs (see [Figure 4-13](#)).

Sabotage Detection

Figure 4-12 Tamper Detection Settings on the Video Analytics Tab

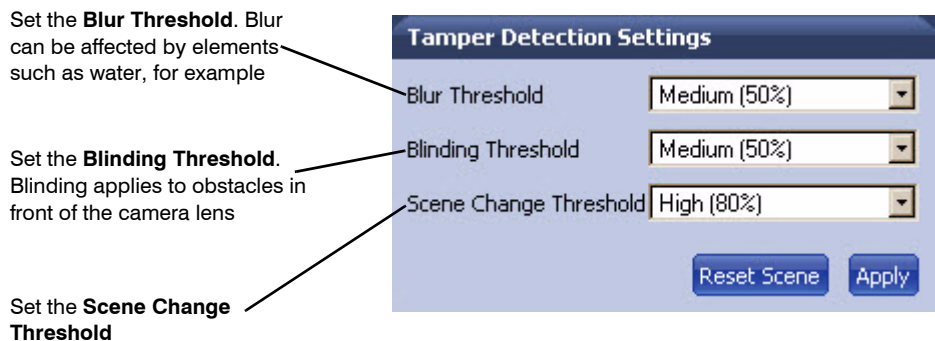

There are three types of sabotage detection in the Tamper Detection Setting tab on the Video Analytics tab: blinding the camera, blurring the video display, and tampering with the camera field of view. The user should note that when the following conditions are applicable, the tamper detection features should be manually disabled to avoid raising false alarms:

- During the configuration of the video display
- While text is overlaid on the video
- If the video display becomes too dark

Figure 4-13 Video Analytics Alarm Message



Configuring Video Blur Detection

The video appears blurred when the camera is exposed to elements such as water. When this occurs, video blurring in the field of view is detected and an alarm message appears (see *Figure 4-13*) above the video display. To detect video blurring:

1. Click the **Video Analytics** tab.
2. In the **Blur Threshold** list, select one of the following options:

Table 4-6 Blur Threshold Values

Value	To detect ...
High (80%)	Maximum video blurring. The alarm message appears when the video display is blurred by 80% or more.
Medium (50%)	Medium video blurring. The alarm message appears when the video display is blurred by 50% or more.
Low (30%)	Minimum video blurring. The alarm message appears when the video display is blurred by 30% or more.

3. Click **Apply**.

Note To turn off video blur detection, select **Disable** in the **Blur Threshold** list. **Disable** is the default value.

Note You must click **Apply** after you make changes to any settings to save those changes. Settings are not saved unless you click **Apply**.

Configuring Camera Blinding Detection

An obstacle in front of the camera lens can blind the camera. When this occurs, camera blinding is detected and an alarm message appears above the video display (see [Figure 4-13](#)). To detect camera blinding:

1. Click the **Video Analytics** tab.
2. In the **Blinding Threshold** list, select one of the following options:

Table 4-7 Blinding Threshold Values

Value	To detect ...
High (80%)	Maximum blinding. The alarm message appears when the HD3MDIP/X camera is blinded by 80% or more.
Medium (50%)	Medium blinding. The alarm message appears when the HD3MDIP/X camera is blinded by 50% or more.
Low (30%)	Minimum blinding. The alarm message appears when the HD3MDIP/X camera is blinded by 30% or more.

3. Click **Apply**.

Note To turn off camera blind detection, select **Disable** in the **Blinding Threshold** list. **Disable** is the default value.

Note You must click **Apply** after you make changes to any settings to save those changes. Settings are not saved unless you click **Apply**.

Configuring Camera Field of View Change Detection

The Web-Client application can detect tampering of the camera field of view and show an alarm message above the video display (see [Figure 4-13](#)). To detect a camera field of view change:

1. Click the **Video Analytics** tab.

- In the **Scene Change Threshold** list, select one of the following options:

Table 4-8 Scene Change Threshold Values

Value	To detect ...
High (80%)	Maximum change in the camera field of view. The alarm message appears when tampering causes at least an 80% change in the HD3MDIP/X camera field of view.
Medium (50%)	Medium change in the camera field of view. The alarm message appears when tampering causes at least a 50% change in the HD3MDIP/X camera field of view.
Low (30%)	Minimum change in the camera field of view. The alarm message appears when tampering causes at least a 30% change in the HD3MDIP/X camera field of view.

- Click **Apply**.

Note To turn off camera field of view change detection, select **Disable** in the **Scene Change Threshold** list. **Disable** is the default value.

Note You must click **Apply** after you make changes to any settings to save those changes. Settings are not saved unless you click **Apply**.

Configuring Video Motion Detection

For motion detection, an Administrator can enable and configure up to 5 zones within a scene. The enabled and configured zones will be monitored for motion.

- Click the Region drop-down menu, then select a region from the five available.
- Click the VMD drop-down arrow, and select **Enable**.
The Regions appear in their default positions.
- Click **Apply**.
- Click and drag the box to resize and place it over the camera image.
- Select the sensitivity level (High, Medium, Low).

Figure 4-14 Video Analytics: Defining a Region

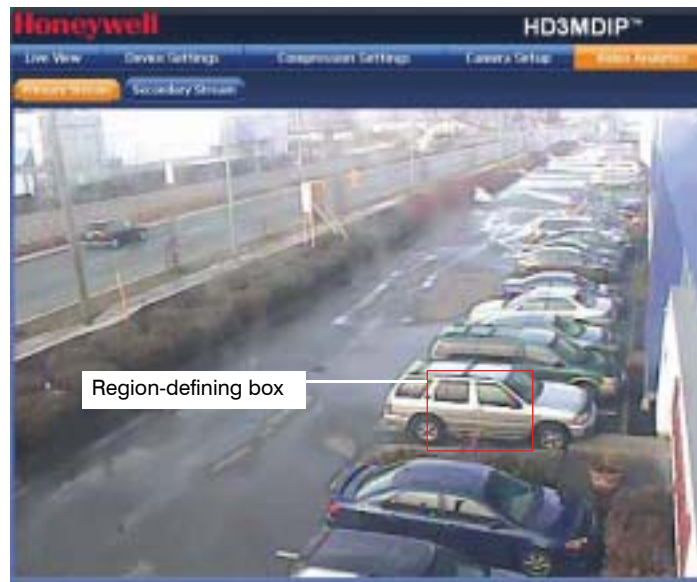

Note To disable a zone, click the VMD drop-down menu, then select **Disable**.

Alarm and Audio

Alarm Settings

Connect external devices such as sirens or flashing lights to the alarm output connector to signal users of the camera that an alarm is activated. Set the **Alarm Output** as **Normally Open** or **Normally Close**. See [Connecting Alarms](#) on page 20 for more information.

When alarm inputs are connected, the camera triggers an alarm only when the normal state (open or closed) changes. An alarm message appears on the Web-Client screen (see [Figure 4-13](#)) to notify the operator.

Audio Settings

The network camera supports bi-directional audio. There are two supported voice band channels that function in full duplex mode. Connect industry-standard line level audio input and output to the back of your camera. See [Connecting Alarms](#) on page 20 for more information.

Audio configuration for your network camera is straightforward.

Figure 4-15 Audio Settings

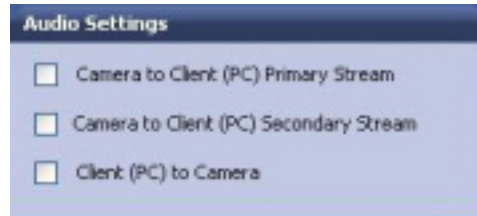

To listen to or capture audio from the camera, enable the **Camera to Client (PC)** check box (Camera to Client (PC)). To listen to audio from the client (PC), enable the **Client (PC) to Camera** check box.

A

Mounting Template

HD3DIP/X Mounting Template

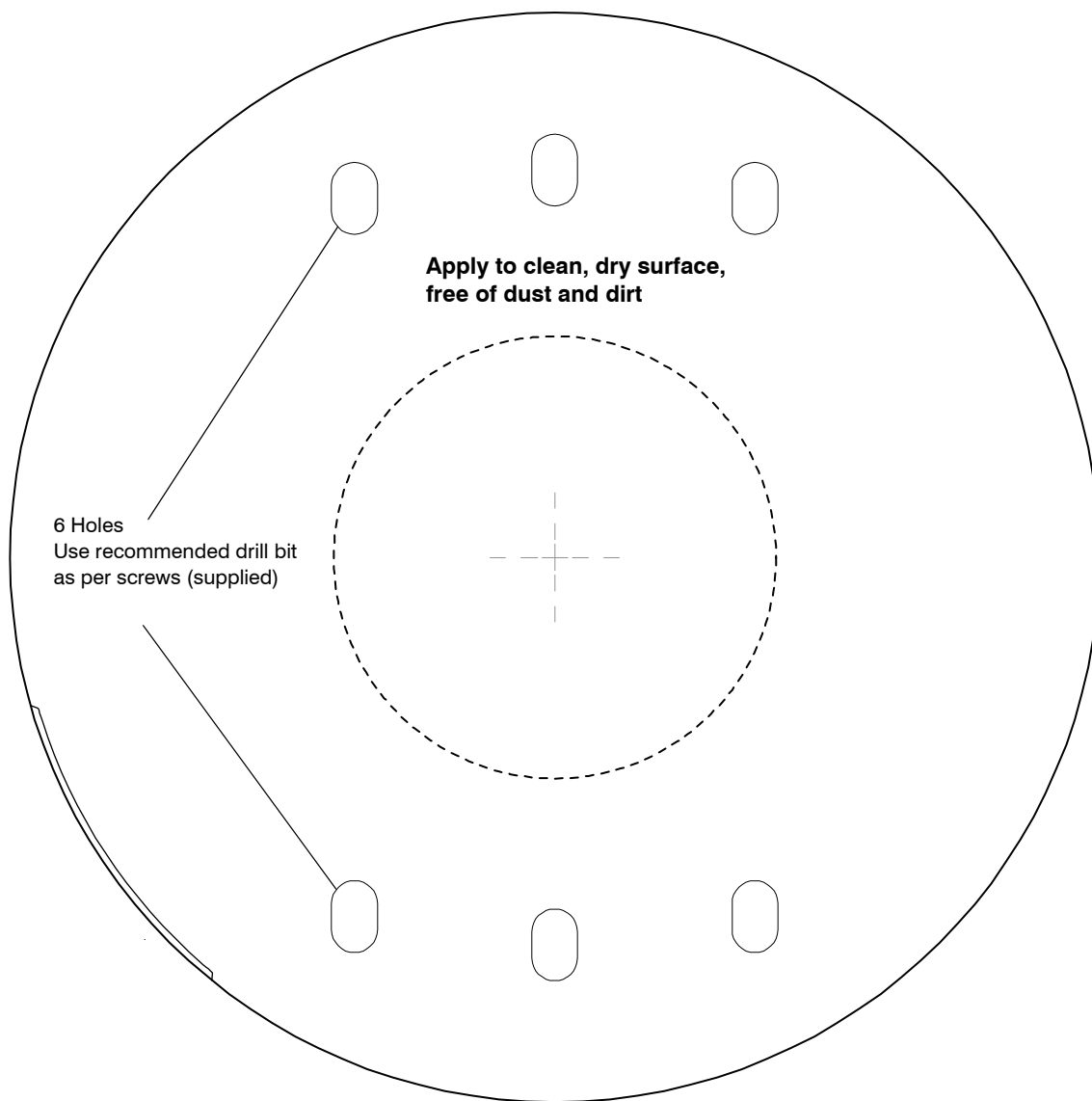

Troubleshooting

Technical Support

Prior to calling Honeywell technical support, refer to the following topics for possible solutions to problems with your HD3MDIP/X camera. To contact the Honeywell Video Systems technical support team, call 1-800-796-2288 (North America only) or send an e-mail to HVSsupport@honeywell.com.

Any equipment returned to Honeywell Video Systems for warranty or service repair must have a Return Merchandise Authorization (RMA) number. The RMA number must be clearly marked on all return packages and internal paperwork.

Problem: Lens Out of Optical Focus

Possible solutions:

1. Verify that the lens cap has been removed from the camera.
2. This can also be caused by dirt, oil, grease, and fingerprints, and so on, that have accumulated on the lens or bubble. Check the lens and bubble, then clean them, if needed.

Caution Use extreme caution when cleaning the lens and bubble so you do not scratch their optical surfaces. Prepare a washed-out cotton cloth or lens cleaning paper with alcohol or lens cleaning liquid. Clean by moving spirally from the lens center towards its rim. Repeat until the lens is completely clean.

Problem: Live View Does Not Display the Expected Video

Possible solutions:

- Ensure that your web browser settings have been configured to allow ActiveX controls (see *Installing the Honeywell IP Utility and HD3MDIP/X Web-Client Software* on page 29 for information on setting up your browser).
- Ensure that the network cable from the camera is connected to both the camera and the network.
- Ensure that the camera assembly board DIP switch settings are configured correctly.

Problem: Cannot Connect to a Device

When the following message (*Figure B-1*) displays in the status bar of the IP Utility, your device connection is limited. Usually this warning indicates that your PC and the device you are connecting to are on different subnets. Contact your network administrator for help to resolve your network issue(s).

Figure B-1 Limited or No Connection Message



Specifications

Note These specifications refer to all models, except where otherwise noted. Specifications are subject to change without notice.

Video Signal Specifications	NTSC	PAL
Scanning System:	Progressive	
Image Sensor:	1/4" CMOS	
Number of Pixels (H x V):	1280 x 720	
Minimum Illumination:	1.0 lux color @ 50 IRE, F1.2	
Video Output (local):	1.0 Vp-p @ 75 Ohms	
S/N Ratio:	50 dB or more (AGC Off)	
Auto Gain Control (AGC):	Off/On, selectable (20 – 40 dB)	
Auto Electronic Shutter (ELC):	1/60 – 1/100,000 sec	1/50 – 1/100,000 sec
Automatic Lens Iris Control:	DC Iris level 1 – 25	
White Balance (AWB):	AWC, MWB (Manual Mode), AWC Push	
Lens Type:	3.3 mm to 12.0 mm Vari-focal Auto Iris, F1.6	
Audio Signal Specifications		
Audio/Two-Way	Line in/out	
Electrical Specifications		
Input Voltage:	24 VAC, PoE IEEE 802.3af	
Input Voltage Range:	17 – 28 VAC	
Surge Suppression	1.5 kW transient	
Power Consumption:	5 W (max)	
Mechanical		
Dimensions (WxH):	See diagrams (Figure C-1 , Figure C-2 , Figure C-4 , Figure C-4)	
Weight:	1.5 lb (0.68 kg) camera only	
Construction:	Housing: Polycarbonate Finish: Matte texture, Off-white	
Connectors:	Local Video Output: 2-pin Molex connector Power Input: Removable screw block Alarm I/O: Removable screw block Audio I/O: Removable screw block Network: RJ45 connector	

Environmental	
Temperature:	Operating: 14°F to 122°F (-10°C to 50°C) Storage: -4°F to 140°F (-20°C to 60°C)
Relative Humidity:	0% to 85%, non-condensing
IP Specifications	
Video Compression:	MPEG-4, MJPEG
Resolutions:	HD: 1280 x 720 SVGA: 800 x 600 VGA: 640 x 480 QVGA: 320 x 240
Software Update:	Field Upgradeable
Frame Rate NTSC/PAL:	Up to 30/25 fps video in all resolutions
Video Streaming:	Dual Streaming: MPEG-4 and MJPEG Controllable frame rate and bandwidth Constant or variable bit rate (MPEG-4)
Security:	Multiple user access levels with password protection
Users:	1 Administrator; 1 Guest
Video access from web browser:	Camera live view for 1 client. Full control of all camera settings available to administrator
Minimum web browsing requirements:	Pentium IV CPU 3.1 GHz or equivalent AMD 1 GB RAM Windows® 2003/XP
Installation, Management, and Maintenance:	Honeywell IP Utility software identifies the IP address, checks the status of the device. Firmware upgrades over HTTP, firmware available at www.honeywellvideo.com .
Supported Protocols:	HTTP, TCP, RTSP, RTP, UDP, ARP, DNS, RTCP, FTP, ICMP, DHCP, Bonjour, IGMP, Telnet
Regulatory	
Emissions:	EN55022
Immunity:	EN 50024
Safety:	EU: 2006/95/EC LVD; UL 60950
Mounts	
HD3MDIP-PK	Pendant mount bracket
HD3MDIP-WK	Wall mount bracket

Figure C-1 HD3MDIP/X Side View with Dimensions

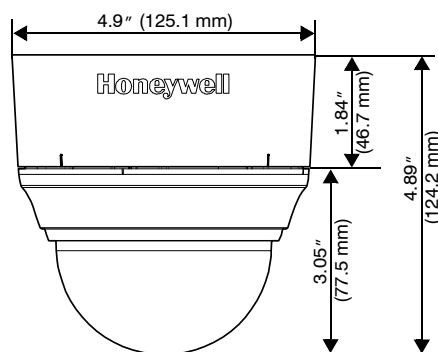

Figure C-2 HD3MDIP/X Side View Dimensions without Skirt

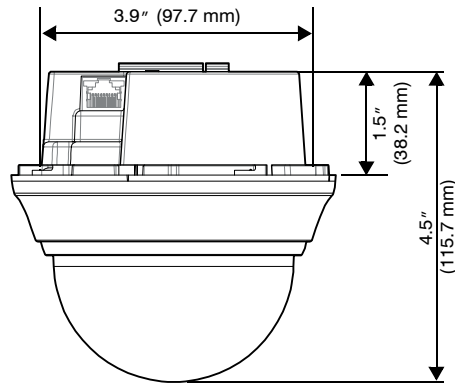

Figure C-3 HD3MDIP/X Side View Dimensions with Adapter Plate

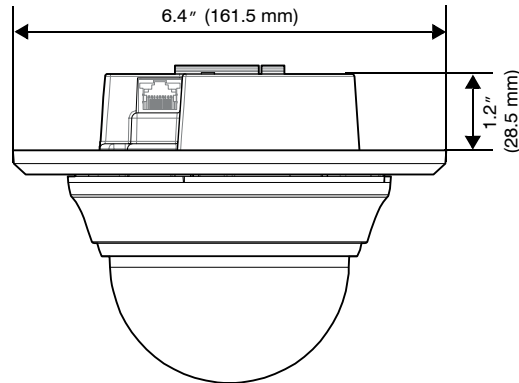
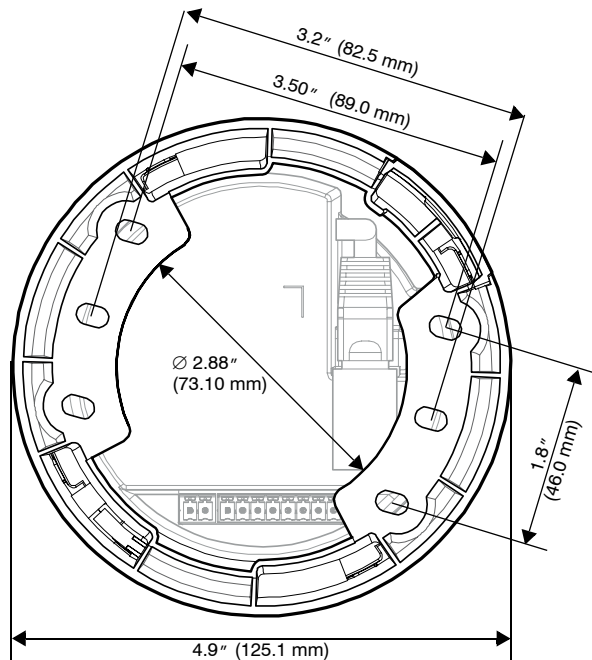

Figure C-4 HD3MDIP/X Bottom View with Dimensions



D

Glossary

AGC (Automatic Gain Control) Video Amplifier in a camera that boosts the amount of video gain (including the noise) to maintain a 1V p-p (1-volt peak-to-peak) video signal output. It becomes operational when the light level is low. The circuit is designed to compensate for fluctuations in scene illumination which would cause the video output level to be too low. If the video level (scene illumination) is adequate, the circuit does not apply any gain to the signal. As the video level falls, more gain is applied by the AGC circuit to the video signal.

ALC (Automatic Light Compensation) Setting in an Auto Iris lens to control the iris opening. Adjusts between peak and average to respond to the bright part of the scene (peak setting) or the average value of the video signal (average setting).

DHCP (Dynamic Host Configuration Protocol) Allows a server to dynamically assign IP addresses to nodes (workstations) automatically. Provides client information including subnetwork mask, gateway address, and DNS (Domain Address Server) addresses.

DNR (Digital Noise Reduction) Digital Noise Reduction eliminates the “flicker” that can appear in an image under certain lighting conditions (for example, fluorescent lighting).

DSS (Digital Slow Shutter) Automatically provides a clear image under low-light conditions (increasing magnification may cause noise/distortion).

Flickerless Eliminates the “flicker” that can appear in an image under certain lighting conditions (for example, fluorescent lighting). This is usually caused by the interaction of the shutter with the AC frequency of the lighting. The flickerless setting changes the camera shutter speed to a value that will not cause flicker (1/100 sec, NTSC, 1/120 sec for PAL). The side effect is that the camera sensitivity is reduced because the electronic iris feature has effectively been turned off and will no longer control the optimum exposure setting for available light conditions.

FOV (Field of View) The part of the scene visible with a particular lens. The height (horizontal) and width (vertical) picture size at a given distance that can be seen through a lens. Generally, shorter focal length lenses have a wider field of view than those with longer focal lengths.

Gain The amplification a system provides to a signal.

IP Address A unique, 32-bit identifier for a specific TCP/IP host computer on a network.

Iris Adjust Adjusts the iris to either open or close in response to changing light conditions.

NTSC (National Television Standards Committee) A standard of specifications for television transmission in the U.S., Canada, Japan, Central American, and half of South America. The North American system uses interlaced scans and 525 horizontal lines per frame at 30 frames per second.

PAL (Phase Alternate Line) A standard of specifications for television transmission for color TV signals used in West Germany, England, Holland, Australia, and several other countries. It uses an interlaced format with 625 lines per frame at 25 frames per second.

PoE (Power over Ethernet) A system designed to transmit electrical power, along with data, to remote devices over a standard twisted pair cable in an Ethernet network.

Shutter Speed The speed at which the charge is read out from the CCD chip. Adjusts the light sensitivity of the camera. A faster (briefer) shutter speed can arrest the motion of a fast moving object (reduce image blur), rendering it sharp. Fast shutter speeds allow less light to all on the CCD and can darken the image. For fast shutter speeds, ensure there is adequate lighting. Usually selected using DIP switches on the side of the camera.

Subnet Mask A number used to identify a subnetwork so that an IP address can be shared on a LAN.

True Day/Night The incorporation of a moving mechanical IR filter within the camera ensures true 24 hour surveillance, providing high quality color images during the day and similar quality black & white images at night when used with IR lighting.

Index

A

ActiveX control [39](#)
 administrator
 privileges [30](#)
 administrator password, default [33](#)
 AGC (Automatic Gain Control) [56](#)
 AGC (automatic gain control) [56](#)
 alarm configuration [62](#)
 alarm output settings [62](#)
 alarm settings [62](#)
 alarms, connecting [20](#)
 ALC (automatic light compensation) [56](#)
 APIPA address [36](#), [37](#), [51](#)
 audio
 connections [19](#)
 audio configuration [63](#)
 audio connections [19](#)
 audio settings [63](#)
 auto
 configuration, IP network [35–37](#)
 device discovery [33](#), [37](#)
 log out, IP Utility [38](#)
 auto exposure settings [55](#)
 Auto White Balance Control mode [57](#)
 Automatic Gain Control [56](#)
 Automatic Light Compensation [56](#)
 AWC (auto white balance control mode) [57](#)

B

bit rate [52](#), [53](#)
 setting [51](#), [53](#)
 viewing statistics [54](#)
 blinding threshold [57](#), [60](#)
 blur threshold [57](#), [59](#)
 Bonjour software [31](#)

C

cabling, connecting [21](#)

camera
 adjusting [25](#)
 components [17](#)
 installation [18](#)
 type [50](#)
 camera blinding [60](#)
 camera components [17](#)
 camera field of view change [60](#)
 camera settings
 AGC [56](#)
 ALC [56](#)
 AWC [57](#)
 DayToNight [56](#)
 detect time [56](#)
 flickerless [56](#)
 MWB [57](#)
 NightToDay [56](#)
 CAT5 Ethernet connector [23](#)
 cautions [10](#), [21](#)
 compliance [10](#)
 components, camera [17](#)
 compression ratio, setting [51](#)
 compression settings [51](#), [52](#)
 bit rate [53](#)
 frame rate [53](#)
 GOP (group of pictures) [53](#)
 maximum bit rate [53](#)
 picture quality [53](#)
 primary stream resolution [53](#)
 secondary stream resolution [53](#)
 target bit rate [53](#)
 configuration
 alarm [62](#)
 audio [63](#)
 configuring
 IP network settings [35–37](#)
 connect button [34](#)
 connecting
 to devices [35](#), [45](#)
 connections
 alarms [20](#)
 audio [19](#)

audio, alarm [19](#)
CAT5 Ethernet [23](#)
video monitor [23](#)
customer service [11](#)

D

DayToNight [56](#)
declaration of conformance [11](#)
default
 passwords [33](#)
default gateway [36](#)
defaults, restore factory [25](#)
device
 connecting [35](#)
 disconnecting [35](#)
 discovering [33](#), [37](#)
 information tab [50](#)
 name [36](#)
DHCP address [36](#), [37](#), [51](#)
digital noise reduction [56](#)
digital slow shutter [56](#)
disconnect button [34](#)
disconnecting, from IP Utility [35](#)
DNR [56](#)
DSS [56](#)

E

EQUIP series
 manuals [32](#)

F

factory defaults, restoration [25](#)
features, camera [13](#)
field of view adjustment [25](#)
field of view change [60](#)
field of view, adjusting [25](#)
finding installed user manuals [32](#)
firmware
 settings [50](#)
 upgrading [34](#)
flickerless [56](#)
frame rate [52](#), [53](#)
 setting [51](#)
 viewing statistics [54](#)
functions, camera [17](#)

G

gateway [36](#), [51](#)
GOP (group of pictures) [52](#), [53](#)
group of pictures (GOP) [53](#)

guest password, default [33](#)
guest user privileges [30](#)

H

HTTP server [33](#)

I

installation
 mounting template [65](#)
installation procedure [16](#)
installation steps [16](#)
installed components [31](#)
installing the camera [18](#)
IP
 address [36](#), [37](#), [51](#)
 APIPA [36](#)
 DHCP [36](#)
 network settings [35–37](#), [50](#)
IP address [36](#)
IP network settings [35](#)
 default gateway [36](#)
 IP address [36](#)
 MAC address [36](#)
 subnet mask [36](#)
IP Utility
 description [29](#)
 disconnecting [35](#)
 discovering devices [33](#), [37](#)
 installing [32](#)
 interface overview [34](#)
 logging on [33](#)
 logging out [38](#)
 uninstalling [41](#)
 user types [30](#)
 web-client and [38](#), [45](#)
IP Utility, logging onto [33](#)

L

LAN [31](#)
launch web-client [34](#), [38](#), [45](#)
launching an IP Web-Client [44](#)
launching the IP Utility [33](#)
lens adjustment [26](#)
lens focus, adjusting [26](#)
limited/no connectivity button [34](#), [35](#)
line lock, adjusting [26](#)
live view tab
 layout [47](#)
log off from the IP Web-Client [46](#)
logging onto an IP Web-Client [44](#)
logging onto the IP Utility [33](#)

M

MAC address [36, 37, 51](#)
 manual white balance mode [57](#)
 manual, configuration, IP network [35–37](#)
 maximum bit rate [53](#)
 maximum bit rate, setting [51](#)
 motion detection [61](#)
 mounting template [18, 65](#)
 mounting, template [18](#)
 MWB (manual white balance) mode [57](#)

N

netmask [36](#)
 NightToDay [56](#)
 normally closed [20](#)
 normally open [20](#)
 NTSC
 video format [51](#)
 video resolution [52](#)
 NTSC, video resolution [54](#)

O

opening an IP Web-Client [44](#)
 operating system [31](#)

P

PAL
 video format [51](#)
 video resolution [52](#)
 PAL, video resolution [54](#)
 password
 defaults [33](#)
 picture quality [52, 53](#)
 power, connecting [21](#)
 primary stream resolution [53](#)
 priority [51](#)
 priority order
 quality or bit rate [52](#)
 processor [31](#)
 profiles, user [30](#)

Q

quality [53](#)
 quality priority setting [54](#)

R

RAM [31](#)

refresh button [34](#)
 resolution [52](#)
 resolution, setting [51](#)

S

scene change threshold [57, 60](#)
 secondary stream resolution [53](#)
 security settings, ActiveX [39](#)
 service [11](#)
 setting
 IP network [34](#)
 settings
 alarm [62](#)
 audio [63](#)
 auto exposure [55](#)
 software
 downloading from website [29, 32](#)
 installing [31, 32](#)
 uninstalling [41](#)
 version [34](#)
 software updates [15](#)
 start menu [31](#)
 statistics
 frame rate [54](#)
 received bit rate [54](#)
 statistics, viewing bit rate [54](#)
 statistics, viewing frame rate [54](#)
 subnet mask [36, 51](#)
 system requirements [31](#)

T

tamper detection [59](#)
 target bit rate [52, 53](#)
 target bit rate, setting [51](#)
 technical support [67](#)
 template, mounting [18](#)
 thresholds, video analytics [57](#)
 troubleshooting [67](#)

U

uninstalling, software [41](#)
 update user manuals [15](#)
 updates, software [15](#)
 upgrading firmware [34](#)
 user manuals, hot to update [15](#)
 user manuals, how to find installed [32](#)
 user profiles [30](#)

V

video

- analytics tab [57](#)
- format [51](#)
- viewing live [47](#)
- video analytics [57](#)
 - blinding threshold [60](#)
 - blur threshold [59](#)
 - camera blinding [60](#)
 - field of view change [60](#)
 - motion detection [61](#)
 - sabotage detection
 - sabotage detection [58](#)
 - scene change threshold [60](#)
 - tamper detection [59](#)
 - video blurring [59](#)
- video blurring [59](#)
- video monitor, connecting [23](#)
- video motion detection [61](#)
- VMD [61](#)

W

- warnings [10, 21](#)
- warranty [11](#)
- web browser [31](#)
- web client
 - compression settings [51](#)
- web-client
 - description [30](#)
 - launching and logging on/off [38](#)
 - user types [30](#)
- website [29, 32](#)
- wiring
 - alarm connection [20](#)
 - connections on board [22](#)

Honeywell Security Group (Head Office)

2700 Blankenbaker Pkwy, Suite 150
Louisville, KY 40299, USA
www.honeywellvideo.com
☎ +1.800.796.2288

Honeywell Security Group Europe/South Africa

Aston Fields Road, Whitehouse Industrial Estate
Runcorn, Cheshire, WA7 3DL, UK
www.honeywell.com/security/uk
☎ +44.01928.754028

Honeywell Security Group Caribbean/Latin America

9315 NW 112th Ave.
Miami, FL 33178, USA
www.honeywellvideo.com
☎ +1.305.805.8188

Honeywell Security Group Pacific

Level 3, 2 Richardson Place
North Ryde, NSW 2113, Australia
www.honeywellsecurity.com.au
☎ +61.2.9353.7000

Honeywell Security Group Asia

35F Tower A, City Center, 100 Zun Yi Road
Shanghai 200051, China
www.asia.security.honeywell.com
☎ +86 21.5257.4568

Honeywell Security Group Middle East/N. Africa

Post Office Box 18530
LOB Building 08, Office 199
Jebel Ali, Dubai, United Arab Emirates
www.honeywell.com/security/me
☎ +971.04.881.5506

Honeywell Security Group Northern Europe

Ampèrestraat 41
1446 TR Purmerend, The Netherlands
www.honeywell.com/security/nl
☎ +31.299.410.200

Honeywell Security Group Deutschland

Johannes-Mauthe-Straße 14
D-72458 Albstadt, Germany
www.honeywell.com/security/de
☎ +49.74 31.8 01.0

Honeywell Security Group France

Immeuble Lavoisier
Parc de Haute Technologie
3-7 rue Georges Besse
92160 Antony, France
www.honeywell.com/security/fr
☎ +33.(0).1.40.96.20.50

Honeywell Security Group Italia SpA

Via della Resistenza 53/59
20090 Buccinasco
Milan, Italy
www.honeywell.com/security/it
☎ +39.02.4888.051

Honeywell Security Group España

Mijancas 1. 3a planta
P.Ind. Las Mercedes
28022 Madrid, Spain
www.honeywell.com/security/es
☎ +34.902.667.800

Honeywell

www.honeywellvideo.com
+1.800.796.CCTV (North America only)
HVSsupport@honeywell.com

Document 800-04132V1 – Rev A – 01/10

© 2009 Honeywell International Inc. All rights reserved. No part of this publication may be reproduced by any means without written permission from Honeywell. The information in this publication is believed to be accurate in all respects. However, Honeywell cannot assume responsibility for any consequences resulting from the use thereof. The information contained herein is subject to change without notice. Revisions or new editions to this publication may be issued to incorporate such changes.

Free Manuals Download Website

<http://myh66.com>

<http://usermanuals.us>

<http://www.somanuals.com>

<http://www.4manuals.cc>

<http://www.manual-lib.com>

<http://www.404manual.com>

<http://www.luxmanual.com>

<http://aubethermostatmanual.com>

Golf course search by state

<http://golfingnear.com>

Email search by domain

<http://emailbydomain.com>

Auto manuals search

<http://auto.somanuals.com>

TV manuals search

<http://tv.somanuals.com>