

Honeywell

T8095A/191108AJ; TS8095A/191108AC; T8095A/Q682

**Heating-only Thermostat and Wallplate or
Heating/Cooling Thermostat and Subbase**

OWNER'S MANUAL

Welcome to the world of energy savings with your new Honeywell thermostat. The Honeywell name is your assurance of accurate control and reliable operation for years to come.

Your new thermostat will automatically lower and raise the temperature in your home one or more times every 24 hours. This allows you to significantly lower your fuel costs, while awakening (or returning home) to a comfortable temperature.

Read this manual to learn how to use your new thermostat.

Recycling Notice



This control contains mercury in a sealed tube. Do *not* place control in the trash at the end of its useful life.

If this control is replacing a control that contains mercury in a sealed tube, do *not* place your old control in the trash.

Contact your local waste management authority for instructions regarding recycling and the proper disposal of this control, or of an old control containing mercury in a sealed tube.

If you have questions, call Honeywell Inc. at 1-800-468-1502.

Table of Contents

	Page
Features of Your Thermostat	4
Setting the Temperature	7
Setting Subbase Switches	8
Inserting Clock Batteries	9
Setting the Clock	10
Programming	11
Troubleshooting	15
Servicing the Thermostat	23
Cycle Rate Adjustment	23
Thermometer Adjustment	24
Warranty	27

Features of Your Thermostat

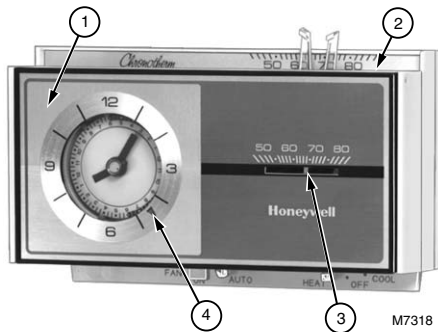

- ① **FLIP-UP COVER.** Lift up to set clock for energy savings and normal temperature periods.

- ② **THERMOSTAT COVER.** Lift up and remove to adjust heat anticipator.
- ③ **THERMOMETER.** Provides accurate room temperature reading.
- ④ **PROGRAM INDICATOR.** Blue indicates low temperature is in effect; red indicates high temperature is in effect.
- ⑤ **CLOCK.** Provides a 24-hour slotted dial to hold the programming pins.
- ⑥ **CLOCK HANDS.** Turn minute hand clockwise  to match the correct AM or PM time to the time indicator.
- ⑦ **TIME INDICATOR.** Arrow head (triangle shape) indicates blue (low) temperature setting or red (high) temperature setting in control on program index wheel. Also indicates time on 24-hour dial.
- ⑧ **PROGRAM INDEX WHEEL.** Controls high and low temperature at specific time of day as set by program pins.

- 9 TEMPERATURE SETTING LEVERS. Left (blue mark) controls low temperature and right (red mark) controls the high temperature.
- 10 PROGRAM PINS. Insert into 24-hour clock dial slots to control program index wheel.
- 11 PIN SLOTS. Located on 24-hour dial at 10-minute intervals for program pin insertion.
- 12 PROGRAM DIAL. 24-hour dial with light band to indicate daytime and dark band to indicate nighttime.
- 13 MANUAL PROGRAM ADVANCE BUTTON. Allows change from comfort to energy savings setting and vice versa without changing the program.
- 14 HEAT ANTICIPATOR SCALEPLATE. Calibrated to match the heating system current draw in amperes.
- 15 ANTICIPATOR SETTING LEVER. Adjust to match the heating system primary control current.

- 16 MERCURY BULB AND BIMETAL ELEMENT (2). Provide automatic temperature control by switching the heating or cooling system on or off.

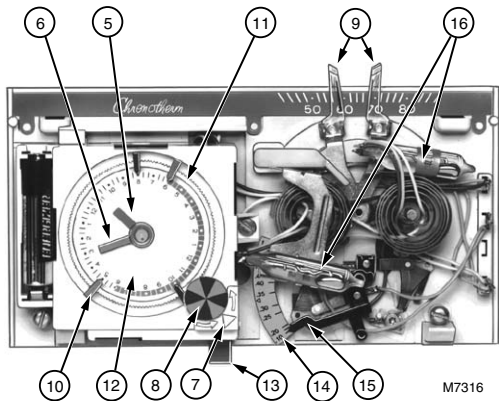

M7316

- 17 191108 WALLPLATE. Provides mounting base and wiring connections for heating-only or cooling-only thermostat.
- 18 Q682 SUBBASE (not included with thermostat; ordered separately). Provides mounting base, wiring connections and manual switching control for heating/cooling thermostat. See Setting Subbase Switches section for additional information.

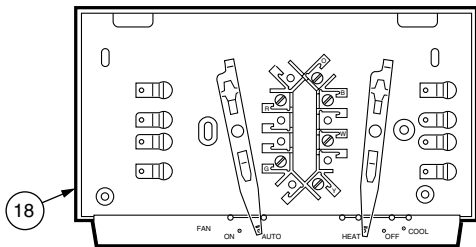
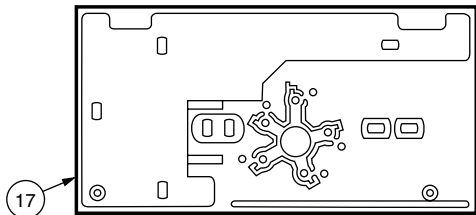

M1809

Setting the Temperature (Fig. 1)

For Heating:

- Set the left lever (blue mark) to the energy savings temperature you want when you are sleeping or your home is unoccupied.
- Set the right lever (red mark) to the temperature you want for normal comfort periods.

NOTE: You may override the time program by setting both the red and blue levers to the same temperature setpoint.

For Cooling:

- Set the left lever (blue mark) to the temperature you want for normal comfort periods.
- Set the right lever (red mark) to the energy savings temperature you want when you are sleeping or your home is unoccupied.

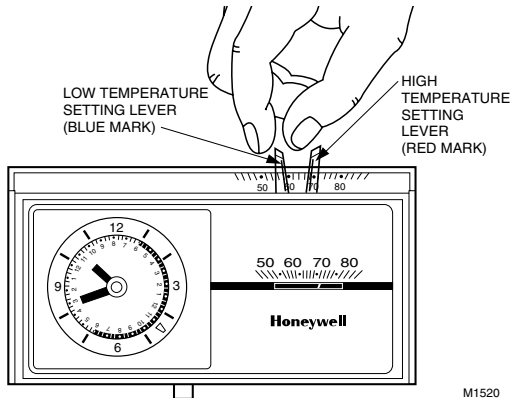

Fig. 1—Setting high and low temperature levers.

Setting Subbase Switches (If Applicable)

The subbase system switch controls system operation as follows:

HEAT—Heating system is controlled by the thermostat. Cooling system is off.

COOL—Cooling system is controlled by the thermostat. Heating system is off.

OFF—Both the heating and cooling systems are off. If the fan switch is in the **AUTO** position, the fan is also off.

AUTO—In cooling only application, only cooling operates. In heating only applications, only heating operates.

The subbase fan switch controls fan operation as follows:

ON—Fan operates continuously.

AUTO—Fan operates with cooling equipment as controlled by the thermostat or with heating equipment as controlled by the plenum fan switch. In electric heat, heat pump and fan coil systems, the fan is controlled by the thermostat in heating and cooling.

To switch positions, use thumb or index finger to slide lever to desired position. Switch lever must stop in detent over desired function indicator mark for proper circuit operation.

Inserting Clock Batteries

Power is supplied to the clock by the 24 Vac transformer. Backup batteries (not included) may be installed to supply power to the clock when power is interrupted. Install batteries in thermostat as shown in Fig. 2. Once a year or when batteries are dead, replace with two new AAA alkaline batteries. We recommend Energizer batteries.

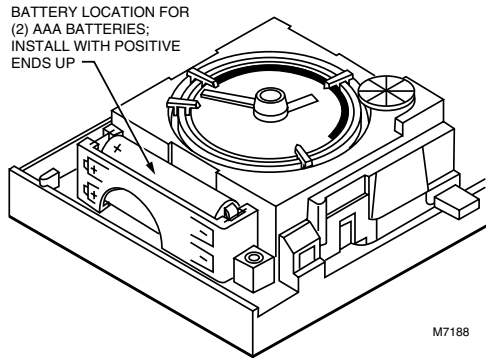



Fig. 2—Inserting Clock Batteries.

Setting the Clock

- ❑ Lift thermostat flip-up cover to find the 24-hour program dial, slotted in 10-minute increments. Adjust the clock to the current time by moving the minute hand carefully in a clockwise  direction. *Do not reverse* the minute hand.
- ❑ After setting the time correctly, the Time Indicator Arrow (triangle shape) will point to the correct time and corresponding daytime (light) or night-time (dark) band of the program dial. See Fig. 3.

EXAMPLE: For 11 PM, the time indicator arrow will point directly to the dark band. For 11 AM, the arrow will point to the light band on the dial.

Daylight Savings Time

When Daylight Savings Time starts, move the minute hand carefully in a clockwise  direction

one hour. When Daylight Savings Time ends, move the minute hand carefully in a clockwise  direction 23 hours. Do *not reverse* the minute hand, or damage to the timer mechanism may occur.

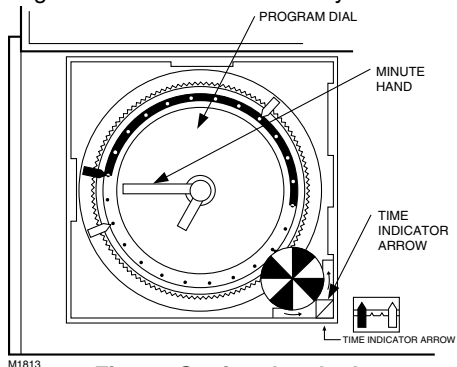

Fig. 3—Setting the clock.

Programming

You can program your thermostat to automatically lower and raise the temperature one or more times every 24 hours, depending on the number of program pins used.

Before setting your program

- ❑ Lift thermostat flip-up cover to find the 24-hour program dial. The slots on the program dial (Fig. 4) are for the program pins that can be inserted at 10-minute intervals.
- ❑ Three red and three blue program pins are included with your thermostat. The red pins start the high-temperature period; the blue pins start the low-temperature period. A heating program is preprogrammed. A red pin is inserted at 6:00 A.M. for high-temperature (comfort period); a blue pin is inserted at 10:00 P.M. for low-temperature (energy saving

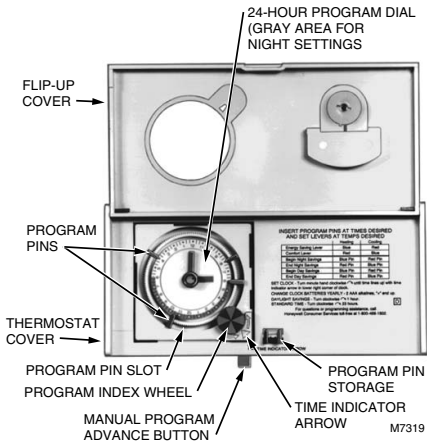

Fig. 4—Program Components.

period). Two additional sets of pins are located in the program pin storage area. You can set up to six temperature changes with the pins supplied. We recommend at least five hours for each energy saving period.

- To change the pins or add a new energy saving period—
 - To insert a pin, push it straight into the selected notch on the program dial until it is completely seated.
 - To remove a pin, press against the program dial and pull the pin straight out. *Do not* attempt to change a pin if it is engaged with the program index wheel.
 - On heating/cooling systems, set the subbase switches to the desired positions. See Setting Subbase Switches section.
 - On heating/cooling systems, you must reset the pins when the seasons change. You will

also probably want to change the lever positions.

Setting the Heating Program:

- Decide when you want the temperature to reach the comfort level. Find the notch on the dial that is one-half hour before this time and insert a *red* pin. The high temperature is in effect. The half-hour head start period gives the furnace time to heat the house before you awaken or arrive home.
- Decide when you want the energy savings period to start and insert a *blue* pin at the notch that corresponds to this time. After the blue pin engages, the low temperature is in effect. The furnace will be off until room temperature drops to the energy saving setpoint.
- You can set both a day and a night program. See Fig. 5 for program examples.

		WINTER			SUMMER		
		TEMPERATURE		PROGRAM PIN IN CONTROL	TEMPERATURE		PROGRAM PIN IN CONTROL
		°F	°C		°F	°C	
NIGHT ENERGY SAVING PERIOD	BEGINS 10:00 PM	58	14	BLUE	80	27	RED
	ENDS 6:00 AM	68	20	RED	75	24	BLUE
DAY ENERGY SAVING PERIOD	BEGINS 7:30 AM	58	14	BLUE	80	27	RED
	ENDS 4:00 PM	68	20	RED	75	24	BLUE

M1690B

Fig. 5—Programming Examples.

Setting the Cooling Program:

- Decide when you want the temperature to reach the comfort level. Find the notch on the dial that is one-half hour before this time and insert a *blue* pin. The low temperature is in effect. The half-hour head start period gives the air conditioner time to cool the house before you awaken or arrive home.
- Decide when you want the energy saving period to start and insert a *red* pin at the notch that corresponds to this time. After the red pin engages, the high temperature is in effect. The air conditioner will be off until room temperature rises to the energy saving setpoint.

Start or End Programs with Manual Program Advance Button

IMPORTANT: *To prevent damage to the program advance mechanism, DO NOT use the program advance button within a 30-minute period before or after a program change.*

The manual program advance button enables immediate, one-time-only program changes to accommodate temporary schedule changes.

Press the button to immediately begin an energy savings period or return to the normal setting. After pressing the button, check the program indicator on the thermostat cover to assure the system is in the desired mode. If the program indicator shows blue, the lower temperature is in effect; if it shows red, the higher temperature is in effect. Using the manual advance button will not affect the stored program.



Troubleshooting

Your Honeywell thermostat requires little or no attention. Most problems can generally be traced to the following:

Problem	Check	Action
No heat. 	— system switch. May be in OFF or COOL position.	Move system switch to HEAT position. See page 8.
	— fuse or circuit breaker.	If blown or tripped, replace fuse or reset breaker.
	— furnace power switch. May be OFF.	Move switch to ON .
	— pilot flame. May be out.	Relight pilot flame according to furnace manufacturer's instructions.
	— thermostat connections.	Turn OFF power to furnace. Check for correct terminal hookups. Repair any frayed or broken wires. Firmly tighten all terminal screws. Turn on power.

(Continued)

Troubleshooting (Continued)

Problem	Check	Action
	— other.	Contact a qualified service technician for assistance.
Energy savings temperature program 12 hours off.	— program dial for proper day or night phase.	Turn clock ahead 12 hours. Move minute hand clockwise  only.
Rooms do not warm up at programmed time. 	— timer program for heating system. May need more time to warm up rooms.	Move red pin one-half hour earlier on the program dial.
Temperature change occurs at the wrong time.	— program pins for correct time locations.	Relocate pins to desired settings.
Room temperatures are not correct.	— positions of thermostat set point levers.	Reset to desired temperatures.
	— position of subbase system switch (heating-cooling model).	Move to desired operating position. Refer to page 8.

(Continued)

Troubleshooting (Continued)

Problem	Check	Action
Room temperatures are not correct (continued).	— thermostat circuits.	HEATING-ONLY SYSTEM—Move temperature setting levers 5° F [3° C] above room temperature. Heating system should start. <i>If the system does not operate, call a qualified service technician.</i> COOLING-ONLY SYSTEM—Move temperature setting levers 5° F [3° C] below room temperature. Cooling system should start. <i>If the system does not operate, call a qualified service technician.</i> HEATING/COOLING SYSTEM—With system switch at HEAT, move temperature setting levers 5° F [3° C] above room temperature. Heating system should start. With system

(Continued)

Troubleshooting (Continued)

Problem	Check	Action
Room temperatures are not correct (continued).		switch at COOL, move temperature setting levers 5° F [3° C] below room temperature. Cooling system should start. <i>If the system does not operate, call a qualified service technician.</i>
Burner-on time too short.	— anticipator setting. (See Fig. 6 for anticipator location.)	Increase anticipator setting by 0.05. Observe burner operation.
Burner-on time too long.	— anticipator setting. (See Fig. 6 for anticipator location.)	Decrease anticipator setting by 0.05. Observe burner operation.
No cooling. 	— system switch. May be in OFF or HEAT position.	Move switch to COOL position. See page 8.
	— fuse or circuit breaker.	If fuse is blown or breaker tripped, replace or reset.

(Continued)

Troubleshooting (Continued)

Problem	Check	Action
No cooling (continued). 	—condenser switch position. (Located outdoors and may be turned OFF.)	Move to ON position.
	—thermostat connections. Check for correct terminal hookups. Repair any frayed or broken wires. Firmly tighten all terminal screws.	Turn OFF power to cooling system.
	—other.	Contact a qualified service technician for assistance.
Thermostat setting and thermometer reading disagree.	—level position of thermostat.	Reinstall thermostat wallplate or subbase. Use a spirit level.
	—area around thermostat for drafts or radiant heat.	Thermostat should be about 5 ft [1.5m] above floor on an inside wall. Contact a qualified service technician for change of location.

(Continued)

Troubleshooting (Continued)

Problem	Check	Action
Thermostat setting and thermometer reading disagree. (continued).	— calibration of thermometer.	See instructions on page 24.
Clock does not run.	— voltage across the two C terminals.	Remove thermostat from the wallplate or subbase and measure the voltage. Refer to the table on page 22 for cause and reaction.
	— pins in program dial. If pins are not completely seated in program dial, jamming with index wheel may occur.	Push down on pins to make sure they are completely seated in program dial.
Clock loses time.	— power. May be interrupted.	Make sure power is on. Reset clock.

(Continued)

Troubleshooting (Continued)

Problem	Check	Action
Clock loses time. (continued).	—high limit control. If clock-powered through system transformer, power to clock and equipment may be off for safety.	Wire separate transformer to power clock, or install backup batteries as shown on page 9.
	—filter. May be clogged. Safety limit on equipment may cut off power to system.	Replace filter and reset clock.
	—backup batteries may need replacement.	Replace with two new AAA alkaline batteries. See page 9.

 1 Not applicable on model used in heating-only system.

 2 Not applicable on model used in cooling-only system.

If this Troubleshooting section has not solved the problem, call a qualified service technician or Honeywell Assistance Center, 1-800-468-1502, Monday-Friday, 7:00 a.m. to 5:30 p.m., Central time, for additional assistance.

Voltage at Clock Terminals

AC Voltage at C-C Terminals	Check	Action
0 Vac.	<ul style="list-style-type: none">— System power off.— Short in clock power supply wiring.— Limit switch contacts stuck open.— Transformer supplying power is burned out.	<ul style="list-style-type: none">— Restore power.— Replace wiring.— Free or replace limit switch.— Replace transformer.
Up to 15 Vac.	<ul style="list-style-type: none">— System transformer used to power the clock is inadequate.— Additional (separate) transformer used to power the clock has inadequate voltage.	<ul style="list-style-type: none">— Use additional (separate) transformer.— Install transformer with proper secondary voltage.
15 to 30 Vac.	<ul style="list-style-type: none">— Spring fingers on thermostat not making proper contact with subbase terminals.— Clock has failed.	<ul style="list-style-type: none">— Rebend spring fingers to a 45 degree angle to assure proper contact.— Replace thermostat.

Servicing the Thermostat

Cycle Rate Adjustment (T8095A only)

The equipment should cycle on and off just enough to keep the room temperature close to the temperature lever settings.

If the thermostat seems to cycle the heating system too fast or too slow, adjust the cycle rate by moving the anticipator setting lever one indicator mark at a time (Fig. 6). Observe the heating system operation after each adjustment.

NOTE: Most hot water systems require a setting of 1.2A.

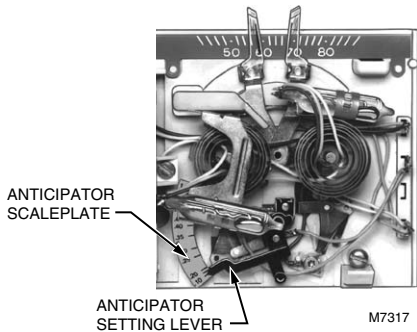

Fig. 6—Heat Anticipator Setting.

Thermometer Adjustment

The thermometer was accurately calibrated at the factory and should only need adjustment if it was dropped or mishandled.

If the setpoint lever and the thermometer reading do not agree, use the following procedure:

1. Remove thermostat cover and open the flip-up cover.
2. Set the thermostat cover on a table near a thermometer of known accuracy.
3. Allow at least five minutes for cover thermometer to sense area temperature, then compare the readings. Be careful not to touch thermometer or breathe on it.
4. If the readings are the same, replace the cover and put the system into operation.
5. If the readings are different, insert a small screwdriver in the thermometer slot, see Fig. 7, and turn it until both thermometers read the same.

6. Replace the thermostat cover and put the system into operation.

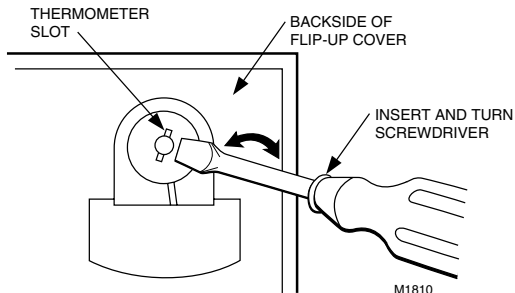

Fig. 7—Thermometer Adjustment.

If you have questions regarding the installation and programming of your Honeywell thermostat, please contact the Honeywell Customer Assistance Center at 1-800-468-1502, Monday-Friday, 7:30 a.m. to 4:00 p.m., Central time. Before you call, please have the following information available: make and model of furnace, old thermostat, and air conditioner.

Limited One-Year Warranty

Honeywell warrants this product, excluding battery, to be free from defects in the workmanship or materials, under normal use and service, for a period of one (1) year from the date of purchase by the consumer. If, at any time during the warranty period, the product is defective or malfunctions, Honeywell shall repair or replace it (at Honeywell's option) within a reasonable period of time.

If the product is defective,

- (i) return it, with a bill of sale or other dated proof of purchase, to the dealer or contractor from which you purchased it, or
- (ii) package it carefully, along with proof of purchase (including date of purchase) and a short description of the malfunction, and mail it, postage prepaid, to the following address:

Honeywell Inc.
Returned Goods Department
1050 Berkshire Lane
Plymouth, MN 55441-4437

in Canada
Honeywell Limited/Honeywell Limitee
740 Ellesmere Road
Scarborough, Ontario M1P2V9

This warranty does not cover removal or reinstallation costs. This warranty shall not apply if it is shown by Honeywell that the defect or malfunction was caused by damage which occurred while the product was in the possession of a consumer.

Honeywell's sole responsibility shall be to repair or replace the product within the terms stated above. HONEYWELL SHALL NOT BE LIABLE FOR ANY LOSS OR DAMAGE OF ANY KIND, INCLUDING ANY INCIDENTAL OR CONSEQUENTIAL DAMAGES RESULTING, DIRECTLY OR INDIRECTLY FROM ANY BREACH OF ANY WARRANTY, EXPRESS OR IMPLIED, OR ANY OTHER FAILURE OF THIS PRODUCT. Some states do not allow the exclusion or limitation of incidental or consequential damages, so this limitation may not apply to you.

THIS WARRANTY IS THE ONLY EXPRESS WARRANTY HONEYWELL MAKES ON THIS PRODUCT. THE DURATION OF ANY IMPLIED WARRANTIES, INCLUDING THE WARRANTIES OF MERCHANTABILITY AND FITNESS FOR A PARTICULAR PURPOSE, IS HEREBY LIMITED TO THE ONE YEAR DURATION OF THIS WARRANTY. Some states do not allow limitations on how long an implied warranty lasts, so the above limitation may not apply to you.

This warranty gives you specific legal rights, and you may have other rights which vary from state to state.

If you have any questions concerning this warranty, please write our Customer Assistance Center, Honeywell Inc., P.O. Box 524, Minneapolis, MN 55440-0524 or call 1-800-468-1502, Monday-Friday, 7:00 a.m. to 5:30 p.m., Central time.

Honeywell

Automation and Control Solutions

Honeywell International Inc.
1985 Douglas Drive North
Golden Valley, MN 55422

Honeywell Limited—Honeywell Limitée
35 Dynamic Drive
Scarborough, Ontario M1V 4Z9



Printed in U.S.A. on recycled
paper containing at least 10%
post-consumer paper fibers.

Download from Www.Somanuals.com. All Manuals Search And Download.

Free Manuals Download Website

<http://myh66.com>

<http://usermanuals.us>

<http://www.somanuals.com>

<http://www.4manuals.cc>

<http://www.manual-lib.com>

<http://www.404manual.com>

<http://www.luxmanual.com>

<http://aubethermostatmanual.com>

Golf course search by state

<http://golfingnear.com>

Email search by domain

<http://emailbydomain.com>

Auto manuals search

<http://auto.somanuals.com>

TV manuals search

<http://tv.somanuals.com>