

HEGS5000/HEGS5001

**Joystick Controller
PTZ, MUX, and VCR Control**

User Guide

ISSUE	DATE	REVISIONS
900.0394		
1.0	February 2006	Initial Release
900.0800		
1.0	June 2006	Correct power supply part # and voltage
1.01	June 2006	Correct RS232 wiring

FCC COMPLIANCE STATEMENT

INFORMATION TO THE USER: This equipment has been tested and found to comply with the limits for a Class A digital device, pursuant to part 15 of the FCC rules. These limits are designed to provide reasonable protection against harmful interference when the equipment is operated in a commercial environment. This equipment generates, uses, and can radiate radio frequency energy and, if not installed and used in accordance with the instruction manual, may cause harmful interference to radio communications. Operation of this equipment in a residential area is likely to cause harmful interference in which case the user will be required to correct the interference at his own expense.

CAUTION: Changes or modifications not expressly approved by the party responsible for compliance could void the user's authority to operate the equipment.

This Class A digital apparatus complies with Canadian ICES-003.

Cet appareil numérique de la Classe A est conforme à la norme NMB-003 du Canada.

	<p>USERS OF THE PRODUCT ARE RESPONSIBLE FOR CHECKING AND COMPLYING WITH ALL FEDERAL, STATE, AND LOCAL LAWS AND STATUTES CONCERNING THE MONITORING AND RECORDING OF VIDEO AND AUDIO SIGNALS. HONEYWELL VIDEO SYSTEMS SHALL NOT BE HELD RESPONSIBLE FOR THE USE OF THIS PRODUCT IN VIOLATION OF CURRENT LAWS AND STATUTES.</p>
--	--



IMPORTANT SAFEGUARDS

1. **READ INSTRUCTIONS** – All safety and operating instructions should be read before the unit is operated.
2. **RETAIN INSTRUCTIONS** – The safety and operating instructions should be retained for future reference.
3. **HEED WARNINGS** – All warnings on the unit and in the operating instructions should be adhered to.
4. **FOLLOW INSTRUCTIONS** – All operating and use instructions should be followed.
5. **CLEANING** – Unplug the unit from the outlet before cleaning. Do not use liquid cleaners or aerosol cleaners. Use a damp cloth for cleaning.
6. **ATTACHMENTS** – Do not use attachments not recommended by the product manufacturer as they may result in the risk of fire, electric shock, or injury to persons.
7. **WATER AND MOISTURE** – Do not use this unit near water or in an unprotected outdoor installation, or any area which is classified as a wet location.
8. **ACCESSORIES** - Do not place this product on an unstable cart, stand, tripod, bracket, or table. The product may fall, causing serious injury to a child or adult and serious damage to the equipment. Use only with a cart, stand, tripod, bracket, or table recommended by the manufacturer, or sold with the product. Any mounting of the product should follow the manufacturer's instructions and should use a mounting accessory recommended by the manufacturer. Wall or shelf mounting should follow the manufacturer's instructions and should use a mounting kit approved by the manufacturer.
9. A product and cart combination should be moved with care. Quick stops, excessive force, and uneven surfaces may cause the product and cart combination to overturn.
10. **VENTILATION** - Slots and openings in the cabinet and the back or bottom are provided for ventilation and to ensure reliable operation of the equipment and to protect it from overheating. These openings must not be blocked or covered. The openings should never be blocked by placing the product on a bed, sofa, rug, or other similar surface. Equipment should never be placed near or over a radiator or heat register. This product should not be placed in a built-in installation, such as a bookcase or rack unless proper ventilation is provided or the manufacturer's instructions have been adhered to.
11. **POWER SOURCES** – This product should be operated only from the type of power source indicated on the marking label. If you are not sure of the type of power supplied to your home, consult your product dealer or local power company. For products designed to operate from battery power or other sources, refer to the operating instructions.
12. **GROUNDING OR POLARIZATION** – The power supply supplied with this unit may be equipped with a polarized alternating-current line plug (a plug having one blade wider than the other). This plug will fit into the power outlet only one way. This is a safety feature. If you are unable to insert the plug fully into the outlet, try reversing the plug. If the plug should still fail to fit, contact your electrician to replace your obsolete outlet. Do not defeat the safety purpose of the polarized plug.
13. **OVERLOADING** – Do not overload outlets and extension cords as this can result in a risk of fire or electric shock.

IMPORTANT SAFEGUARDS

14. **POWER-CORD PROTECTION** – Power supply cords should be routed so that they are not likely to be walked on or pinched by items placed upon or against them, paying particular attention to cords and plugs, convenience receptacles, and the point where they exit from the monitor.
15. **OBJECT AND LIQUID ENTRY** – Never push objects of any kind into this unit through openings as they may touch dangerous voltage points or short-out parts that could result in a fire or electric shock. Never spill liquid of any kind on the unit.
16. **SERVICING** – Do not attempt to service this unit yourself as opening or removing covers may expose you to dangerous voltage or other hazards. Refer all servicing to qualified service personnel.
17. **DAMAGE REQUIRING SERVICE** – Unplug the unit from the outlet and refer servicing to qualified service personnel under the following conditions:
 - a. When the power-supply cord or plug is damaged.
 - b. If liquid has been spilled, or objects have fallen into the unit.
 - c. If the unit has been exposed to rain or water.
 - d. If the unit does not operate normally by following the operating instructions. Adjust only those controls that are covered by the operating instructions as an improper adjustment of other controls may result in damage and will often require extensive work by a qualified technician to restore the unit to its normal operation.
 - e. If the unit has been dropped or the enclosure has been damaged.
 - f. When the unit exhibits a distinct change in performance - this indicates a need for service.
18. **REPLACEMENT PARTS** – When replacement parts are required, be sure the service technician has used replacement parts specified by the manufacturer or have the same characteristics as the original part. Unauthorized substitutions may result in fire, electric shock or other hazards.
19. **SAFETY CHECK** – Upon completion of any service or repairs to this unit, ask the service technician to perform safety checks to determine that the unit is in proper operating condition.
20. **LIGHTNING AND POWER LINE SURGES** – For added protection of this unit during a lightning storm, or when it is left unattended and unused for long periods of time, unplug it from the wall outlet and disconnect the cable system. This will prevent damage to the unit due to lightning and power-line surges.
21. **HEAT** – The product should be situated away from heat sources such as radiators, heat registers, stoves, or other products (including amplifiers) that produce heat.
22. **INSTALLATION** – Do not install the unit in an extremely hot or humid location, or in a place subject to dust or mechanical vibration. The unit is not designed to be waterproof. Exposure to rain or water may damage the unit.
23. **WALL OR CEILING MOUNTING** – The product should be mounted to a wall or ceiling only as recommended by the manufacturer

EXPLANATION OF GRAPHICAL SYMBOLS

	The lightning flash with arrowhead symbol within an equilateral triangle is intended to alert the user to the presence of uninsulated "dangerous voltage" within the product's enclosure that may be of sufficient magnitude to constitute a risk of electric shock to persons.
	The exclamation point within an equilateral triangle is intended to alert the user to the presence of important operating and maintenance (servicing) instruction in the literature accompanying the product.

CAUTION

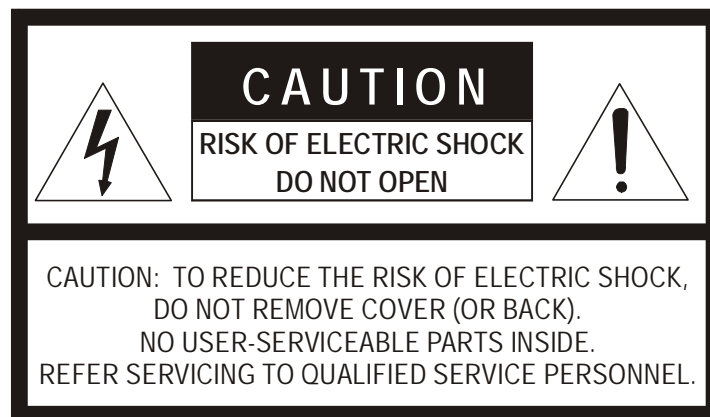

WARNING



	WARNING: TO REDUCE THE RISK OF FIRE OR ELECTRIC SHOCK, DO NOT EXPOSE THIS PRODUCT TO RAIN OR MOISTURE.
	WARNING: DO NOT INSERT ANY METALLIC OBJECT THROUGH VENTILATION GRILLS THIS PRODUCT TO RAIN OR MOISTURE.
	WARNING: THIS UNIT MUST BE OPERATED WITH A PROPERLY GROUNDED 3-PIN CONNECTION. NON-OBSERVANCE OF THIS STANDARD PRACTICE MAY RESULT IN A STATIC ELECTRICITY BUILD-UP THAT MAY RESULT IN AN ELECTRIC SHOCK WHEN EXTERNAL CONNECTIONS ARE TOUCHED.

TABLE OF CONTENTS

SECTION 1: INTRODUCTON	1
1.1 PRODUCT DESCRIPTION.....	1
1.2 FEATURES.....	1
1.3 ADDITIONAL INFORMATION.....	1
SECTION 2: INSTALLATION AND EQUIPMENT SETUP.....	3
2.1 CONNECTIONS.....	3
2.2 INSTALLATION DIAGRAMS.....	4
2.3 EQUIPMENT SETUP.....	7
2.3.1 KD6/HD6 Setup	7
2.3.2 Multiplexer Setup.....	7
2.3.3 VCR Setup	7
SECTION 3: MODES OF OPERATION.....	9
3.1 MODES OF OPERATION.....	9
3.2 MODE CONFIGURATION.....	9
3.3 POWER-UP	10
3.3.1 Default Password.....	11
3.3.2 Default User Defined Settings.....	11
3.3.3 LCD Display	11
3.3.4 Log Out.....	12
SECTION 4: SYSTEM SETUP.....	13
4.1 SETTING UP THE CONTROLLER	13
4.2 NAVIGATING THE MENUS.....	13
4.3 MENUS	14
SECTION 5: STANDALONE MODE HEGS5000.....	19
5.1 OPERATION.....	19
5.1.1 Camera (KD6/HD6) Selection.....	20
5.1.2 Manual Control	20
5.2 KD6/HD6 DOME MENU	22
5.2.1 Dome Setup Menu.....	23
5.2.2 Program PreShot.....	25
5.2.3 Recall PreShot	28
5.2.4 List Programmed PreShots	29
5.2.5 Programming a VectorScan	30
5.2.6 Run VectorScan.....	31
5.2.7 List VectorScans.....	32

TABLE OF CONTENTS, CONTINUED

5.2.8	List VectorScan Contents	32
5.2.9	Program a Tour.....	33
5.2.10	Run a Tour	33
5.2.11	Delete a Tour	34
5.2.12	Programming Sector IDs	34
5.2.13	Programming/Editing/Deleting Privacy Zones	36
5.2.13.1	Programming/Editing/Deleting Privacy Zones, Sony Camera	36
5.2.13.2	Programming/Editing/Deleting Privacy Zones, Hitachi Camera.....	39
5.2.13.3	Changing the Privacy Zone Password.....	41
5.2.14	Nightshot Mode	42
SECTION 6: MUX MODE OPERATION HEGS5001		43
6.1	INTRODUCTION	43
6.2	SPOT MONITOR OPERATION	44
6.2.1	Absolute Mode.....	45
6.2.2	Relative Mode	45
6.3	MULTIPLEXER CONTROL.....	46
6.4	VCR CONTROL.....	47
SECTION 7: DOWNLOADING NEW FIRMWARE TO THE HEGS5000.....		49
7.1	INTRODUCTION	49
7.2	CONNECTING THE HEGS5000/HEGS5001 TO YOUR PC	49
SECTION 8: TROUBLESHOOTING AND MAINTENANCE		55
8.1	TROUBLESHOOTING.....	55
8.2	DIAGNOSTICS.....	55
8.2.1	Joystick Test Modes	55
8.3	SERVICING THE CONTROLLER	56
8.4	PREVENTIVE MAINTENANCE.....	56
SECTION 9: SPECIFICATIONS		57

LIST OF FIGURES

Figure 1: Installing Honeywell Multiplexer, VCR, and Domes	4
Figure 2: Connection Diagram 1	5
Figure 3: Connection Diagram 2.....	6
Figure 4. LCD	11
Figure 5. HEGS5000 English Text Overlay	19

LIST OF FIGURES, CONTINUED

Figure 6. HEGS5000 Icon Overlay	19
Figure 7. MUX Mode English Text Version	43
Figure 8. MUX Mode Icon Version	43
Figure 9: Ultrak Code Server Window	50
Figure 10: CommPort Properties Window	50
Figure 11: Enabling the CommPort	51
Figure 12: Invalid Port Error	51
Figure 13. Transmit Hex File	51
Figure 14: Send Hex File Window	52
Figure 15: Selecting the Hex File to Send	52
Figure 16: Sending Hex File Status Window	53
Figure 17. Transfer Complete	53

LIST OF TABLES

Table 1. Manual Control.....	20
Table 2. DOME MENU () Key – Access/Exit Dome Menus.....	22

Notes:

SECTION 1: INTRODUCTON

1.1 PRODUCT DESCRIPTION

The HEGS5000 is a controller designed to provide simple operation of the Honeywell KD6/HD6 series domes, VCRs, and multiplexers: 16 multiplexers, 16 VCRs and 256 domes can be controlled via the HEGS5000's two serial ports. All functions of the individual units are supported remotely and intelligently.

1.2 FEATURES

The HEGS5000 controller includes the following features:

- Integrated control of Domes, VCRs, and Multiplexers.
- Control of up to 256 Honeywell KD6/HD6 domes
- Remote control of up to 16 Honeywell KR4XXXXX Series VCRs.
- Remote control of up to 16 Honeywell AXCD or AXMD series, HXCT or HXMT series, KX16XXCX series, KQ7300CX, KX04XXCX and KX09XXCX multiplexers.
- LCD Display
- Separate logins for Operators and Master Users (supervisors)

1.3 ADDITIONAL INFORMATION



CAUTION: Users of this product are responsible for checking and complying with all federal, state, and local laws and statutes concerning the monitoring and recording of video and audio signals. Honeywell shall not be held responsible for the use of this product in violation of current laws and statutes.

Notes:

SECTION 2: INSTALLATION AND EQUIPMENT SETUP

2.1 CONNECTIONS

A terminal block is provided for connection between the HEGS5000 controller and peripheral equipment. A coiled cable is provided for connection between the HEGS5000 and the terminal block. Plug one end of the coiled cable into the connector on the back of the HEGS5000 and the other end into the jack on the terminal block.

Description	
Power Supply	Connect the power supply, part number 849193-0089, provided with the unit.
COM1 (RS485 output port)	Used for controlling Honeywell KD6/HD6 series domes.
COM2 (RS232 serial port)	Used for controlling Honeywell multiplexers and VCRs.

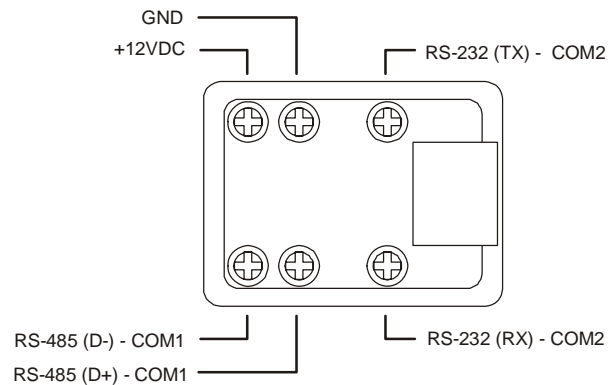

Refer to Section 2.2 for installation diagrams for connection to Multiplexers, VCRs, etc.

2.2 INSTALLATION DIAGRAMS

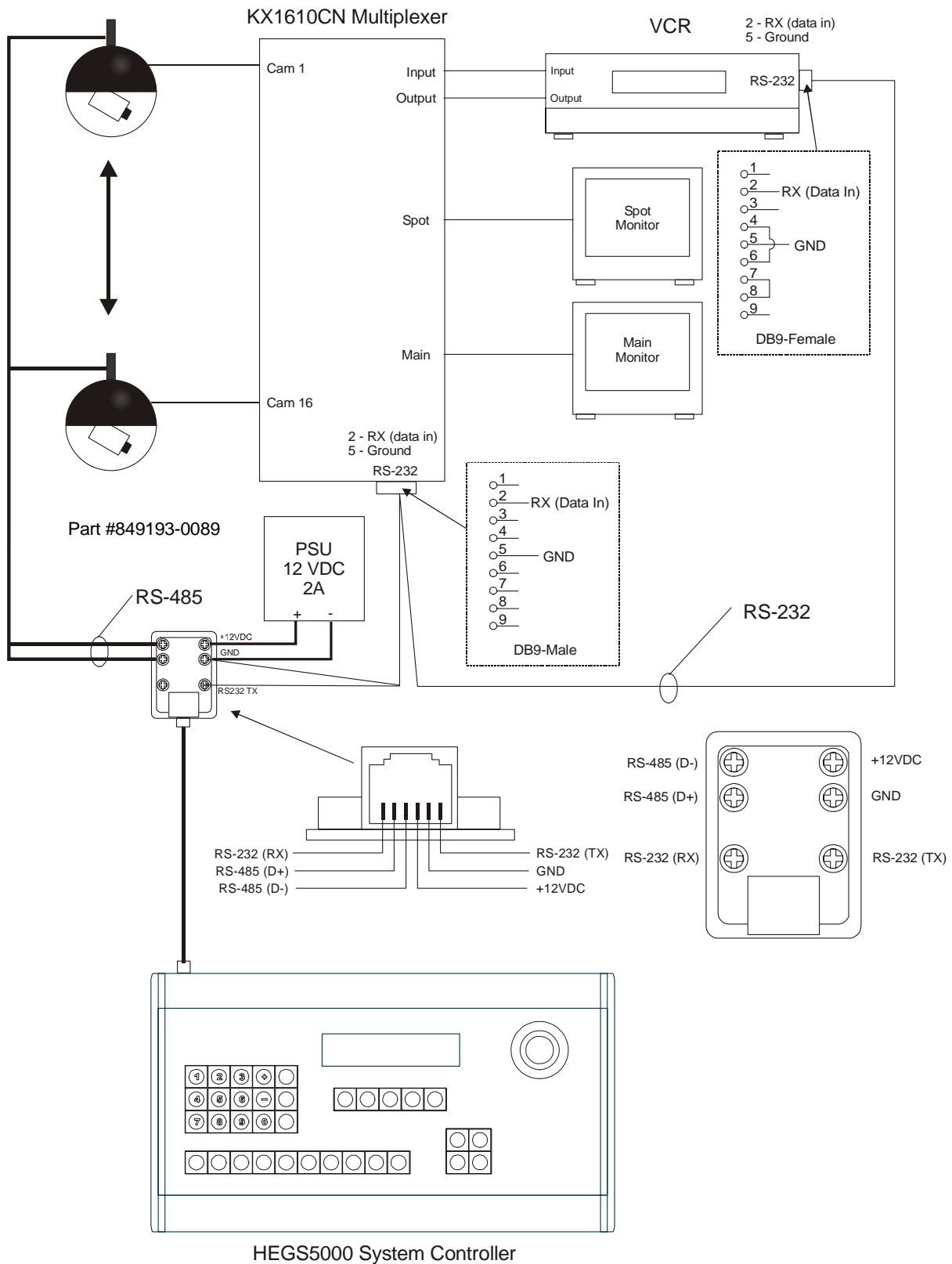

Figure 1: Installing Honeywell Multiplexer, VCR, and Domes

2.2 INSTALLATION DIAGRAMS, CONTINUED

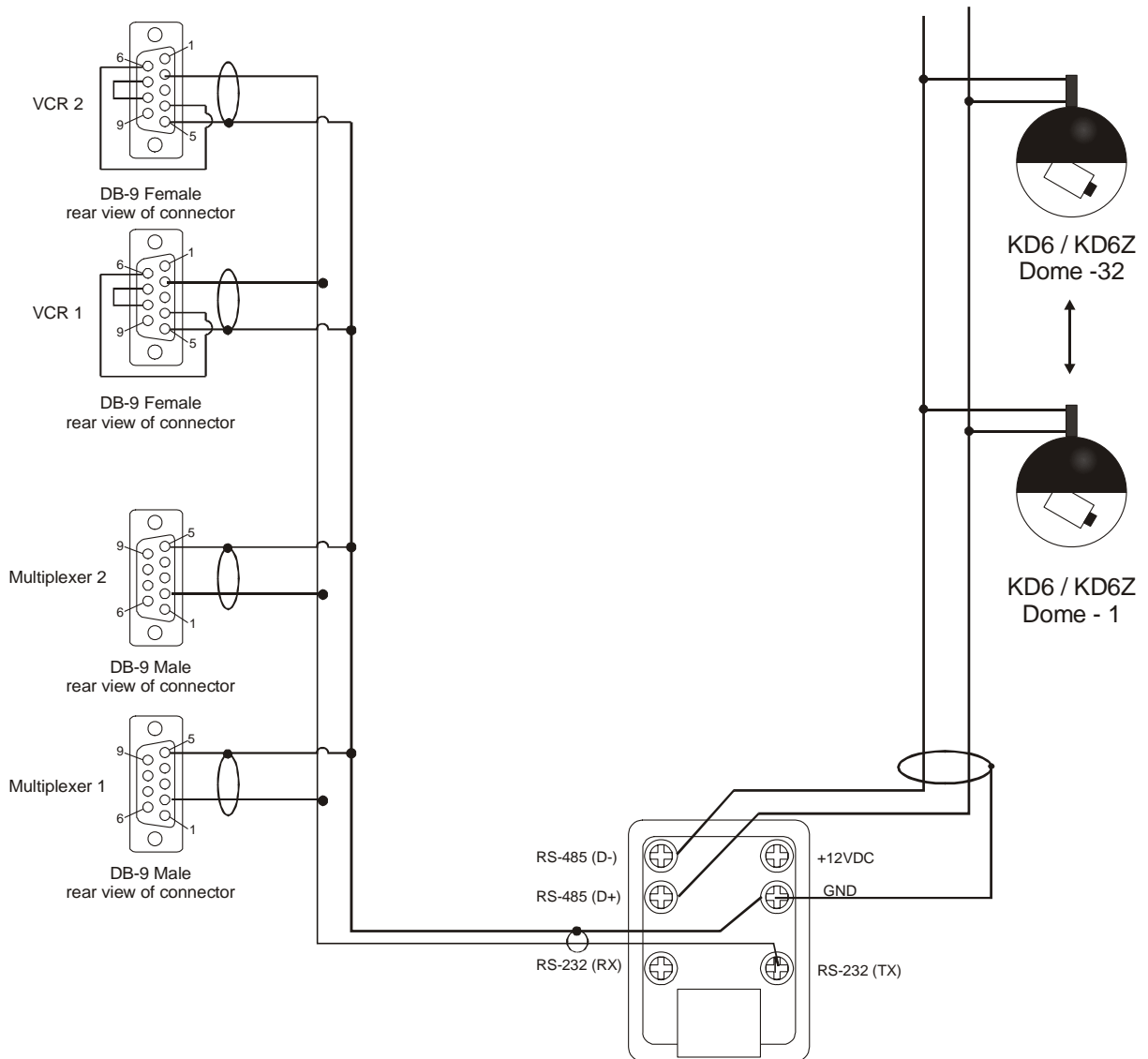

Figure 2: Connection Diagram 1

2.2 INSTALLATION DIAGRAMS, CONTINUED

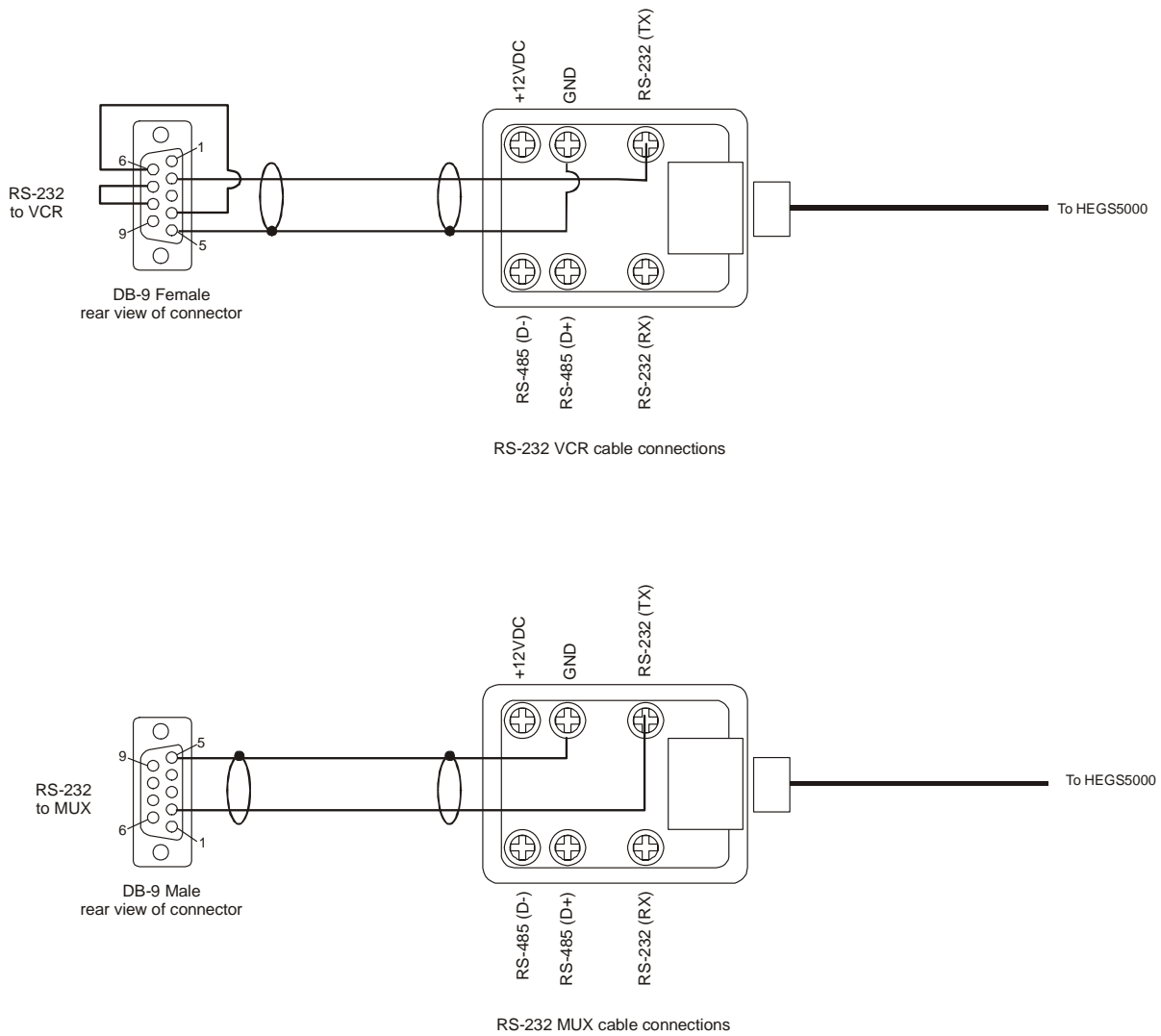

Figure 3: Connection Diagram 2

2.3 EQUIPMENT SETUP

2.3.1 KD6/HD6 Setup

The KD6/HD6 Dome must be set to Honeywell Diamond protocol. The address of the KD6/HD6 dome must be set to match the address set for that camera number in the HEGS5000. That is, the KD6/HD6 camera defined as camera 1 in the HEGS5000 system setup must be physically addressed 001 using the rotary switches on the KD6/HD6 receiver board.

Refer to the KD6 or HD6 Series User Manual for switch settings and detailed operation.

2.3.2 Multiplexer Setup

The multiplexer should be set up as follows:

Communication: RS232

Baud: 1200

The address of the multiplexer with cameras 1-16 must be set at 1, cameras 17 –32 set at 2. See the multiplexer user manual for more details.

2.3.3 VCR Setup

The VCR address is set to NONE as the default. To function properly, VCR 1 must be set to address 1 and VCR 2 to address 2. See the VCR user manual for more details.

Notes:

SECTION 3: MODES OF OPERATION

3.1 MODES OF OPERATION

There are two modes of operation when using the HEGS5000 as a standalone controller:

1. HEGS5000 = Standalone = PTZ control (KD6/HD6 and KDZ series) only. Note: KDZ series domes have been discontinued.
2. HEGS5001 = MUX Mode = MUX/VCR control capability and PTZ control

There is a third mode of operation that is only for use with the HSX3208L Matrix Video Switcher.

3. HEGS5002 = System = HSX3208L Switcher. Refer to the HSX3208L Switcher User Manual for setup and operation of the HEGS5000 in System mode.

The default configuration is Standalone mode (PTZ control only). To change the configuration, refer to Section 3.2

3.2 MODE CONFIGURATION

To configure the HEGS5000 mode of operation, perform the following steps.

1. Power-up the HEGS5000. The following messages are displayed on the LCD display.

```
Boot Mngr MMDDYY  
519685-1980 A
```

```
Booting in 5s
```

2. Before the unit counts down to 0, press 1. The LCD displays:

```
< Run Bank >  
** Standalone **
```

Note: The current configuration is displayed with ** on both sides as shown above.

3.2 MODE CONFIGURATION, CONTINUED

3. Press ← or → keys to scroll through the available options.
 - Standalone (control KD6/HD6 PTZs only)
 - Mux Mode (control multiplexers, VCRs, and KD6/HD6 PTZs)
 - System Mode (must be used with HSX3208L switcher)
 - Stdalone/Mux Fw. (upload new firmware to the HEGS5000). Refer to Section 7 for uploading the latest firmware.
 - System Firmware (upload new firmware to the HEGS5000 system controller). Refer to the HSX3208L User Manual to upload the latest firmware.
4. When the desired option is displayed, press **Enter** (↵). The controller continues booting for the selected mode.

3.3 POWER-UP

The power-up process is the same for both the MUX mode and the Standalone mode of operation. When power is applied to the HEGS5000, the LCD displays the following messages:

```
Boot Mngr MMDDYY
519685-1980 A
```

```
Booting in 5s
```

 (counts down to 0)

After 5 seconds, the current application starts. The selected mode (HEGS5000 or HEGS5001) is displayed.

```
HEGS5000 MMDDYY
519686-1980 A
```

```
HEGS5001 MMDDYY
519686-1980 A
```

Note: if the configuration has been changed by the user, this screen displays, "Loaded Saved Configuration"

Then the login screen is displayed.

Two levels of login are available: **Master** and **Operator**.

```
System login
Password: _ _ _ _
```

Enter the four-digit password to login. Refer to paragraph 3.3.1 for default passwords.

3.3.1 Default Password

Master Default Password is 1994.

Operator Default Password is 1111.

Master mode has access to all menus. **Operator** mode allows access to all menus except those in which changes to system setup are involved. The table below shows which menus and functions are available for each mode.

Description	Operator	Master
Save PreShot - KD6/HD6 domes	1-10 Only	Yes
Recall PreShot on KD6/HD6 domes	Yes	Yes
Programming a VectorScan - KD6/HD6 domes	No	Yes
Running a programmed VectorScan – KD6/HD6 dome	Yes	Yes
Programming a tour menu – KD6/HD6 dome	No	Yes
Running a tour – KD6/HD6 dome	Yes	Yes
NightShot On/Off –KD6/HD6	Yes	Yes
Auto iris on/off – KD6/HD6	Yes	Yes
Programming a sector – KD6/HD6	No	Yes
Programming a privacy zone – KD6/HD6	No	Yes
Access to the KD6/HD6 dome setup menu	No	Yes
Access to the System Setup Menu	No	Yes
Access to the multiplexer setup menu	No	Yes

3.3.2 Default User Defined Settings

To return the controller to the user-defined default settings, perform the following steps.

1. Power the unit down and back up.
2. When the LCD display shows the controller is Booting Run Menu key during the 5-second booting process.

3.3.3 LCD Display



Figure 4. LCD

In the above display, the HEGS5000 is configured for MUX mode of operation. Spot01 is the Spot Monitor and Multiplexer the controller is currently controlling. This will change if you have more than one multiplexer in your system. Spot 01 is the spot monitor for multiplexer one; Spot 02 is the spot monitor for multiplexer two, etc. Refer to section 6 for MUX operation.





Cam001 is the camera currently being controlled.

If the controller is configured for Standalone mode of operation; the Spot monitor is not displayed.

3.3.4 Log Out

To log off the controller, perform the following steps.

Run

1. Press the **Run Menu** () key until Logout is displayed on the LCD display.
2. Press **Enter** () . Yes is displayed on the LCD display.
3. Press **Enter** () to select Yes or press **Menu ESC** () to cancel logging out. The LCD display returns to the login password.

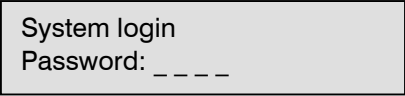

System login
Password: _ _ _ _

SECTION 4: SYSTEM SETUP

4.1 SETTING UP THE CONTROLLER

The components controlled by the HEGS5000 are defined in the SYSTEM MENU. This menu is available only when logged in as a **Master** User.

- The SYSTEM MENU is in tree structure.
- Several tools, including the LEFT (←) and RIGHT (→) keys, **Enter** key (↵), and the UP (↑) and DOWN (↓) functions on the joystick are used to navigate through the menus.
- Press **Enter** (↵) or **Zoom In** (clockwise) to select an option and go down one level.
- Press **Clear/Manual** (←) or **Zoom Out** (counterclockwise) to go back one step or up one menu level.

4.2 NAVIGATING THE MENUS

To access the System Setup, press the System Menu () key.

The LCD screen will indicate the level, menu name, and additional options.

Note: If the controller is set for Standalone Mode, the menus start with the Camera Menu (Level [3.0])



Using the figure, the LCD shows that the controller is at the Multiplexer Menu, which is menu 1. More indicates that there are more options or submenus available under this menu.

- To select this menu, press **Enter** (↵).
- To move to another menu, use the **joystick tilt up and tilt down** functions. Moving the joystick up will change it to menu 2, then menu 3, and so on. You can view the menus in reverse order by moving the joystick down.
- If you have selected a menu incorrectly, press **Clear/Manual** (←) or “**Zoom Out**” to return to the previous level.
- Once in a submenu, use the joystick or the **Enter** (↵) key to navigate through the available options.

4.2 NAVIGATING THE MENUS, CONTINUED

- To exit the System Menu, use the joystick to choose **menu 8 (Exit)**, then press **Enter** (↵) or “**Zoom Out**” until the setup menu is exited. When you exit a menu, the controller displays Saving Settings, Please Wait. After the settings have been saved, the controller returns to normal operation.

4.3 MENUS

Multiplexers		
Menu Name	Menu Number	Description
Mux's	1.0	Used to set the type of multiplexer and the number of multiplexers in the system. Press Enter (↵) to access this menu.
Mux type	1.1	Type of Multiplexers – only one type of multiplexer per system (KX16xxCX, KQ7300Cx, KX04xxCx, KX09xxCx, KXR23xxU, KX1630CU, MXXD9E, MXXD16E supported). Note: Use KX16xxCX, KX04xxCx, or KX09xxCx for KX16xxMX, KX04xxMx, or KX09xxMx respectively. For AXCD, AXMD, HXCT, or HXMT series multiplexers, use MXXD9E or MXXD16E depending on the number of channels (9 or 16). Press Enter (↵).
No. of Muxes	1.2	Number of Multiplexers – 1 to 16 allowed. Each multiplexer must have the address set at its logical number. Press Enter (↵).

Recorders		
Menu Name	Menu Number	Description
Recorders	2.0	Used to set the type of VCR and the number of VCR's in the system. Press Enter (↵) to access this menu.
VCR Type	2.1	Type of VCR – Only one type of VCR per system (KR4xxxCx). Press Enter (↵).
No. of VCRs	2.2	Number of VCR's – 1 to 16 allowed -each VCR must have the address set at its logical number. Press Enter (↵) or joystick tilt down to move to the next submenu. Press Clear/Manual (←) to exit this menu.

4.3 MENUS, CONTINUED

Cameras		
Menu Name	Menu Number	Description
Cameras	3.0	Used to set the type of camera and the address to which the controller sends commands when this camera is selected on the monitor or spot monitor if the controller is in Mux Mode . Press Enter (↵) to access this menu.
Camera Num	3.1	Camera Number – use the number keys or the + and – keys to select the camera number. Once the camera number is selected, press Enter (↵) to move to the next submenu.
(Cam Num) Type	3.1.1	Used to select the type of camera for each camera number. The camera number in parentheses indicates which camera is currently selected. To set camera type, use the + and – keys to select between the four camera types (KD6/HD6, KD6-Z, Fixed Camera, and Pan Tilt Head). Press Enter (↵) or joystick tilt down to move to the next submenu.
Tip: To make it easy to setup camera TYPES and camera ADDRESSES, start with Camera 1 TYPE and simply press Enter (↵) after setting the type to go to the address. Set the address and then press Enter (↵) to move to the TYPE for camera 2. Continue setting the TYPE and ADDRESS for each subsequent camera until all cameras are done.		
(Cam Num) Address	3.1.2	Used to set the camera address. The camera number in parentheses indicates which camera is selected. Enter the required address of the camera using the number keys or the + and – keys. For KD6-Z domes, the address must be the same as the value set in menu 5.0 setup. Press Enter (↵) to move to the next camera. Press Clear/Manual (←) to exit this menu.

4.3 MENUS, CONTINUED

KDZ SETUP		
Menu Name	Menu Number	Description
KDZ Setup	4.0	Used to program the address of any KDZ connected to the HEGS5000. Press Enter (↵) to access this menu.
Serial No.	4.1	Using the number keys, enter the serial number of the KDZ dome. Press Enter (↵). The serial number is supplied with the dome and is printed on the dome.
KD6-Z Addr	4.2	Enter the required address of the dome using the number keys or + and – keys. Press Enter (↵).
Set Address	4.3	Press Enter (↵) to confirm the information and send the serial number and address to reprogram the KD6-Z dome. Press Clear/Manual (←) to exit this menu.

Note: The above setup menu is simply a tool to allow the address of the KDZ dome to be programmed from the controller. This information is not stored in the controller. The address of each KDZ dome can be set one after each other without having to exit this menu. Refer to the KDZ User Manual for detailed information on programming and controlling a KDZ camera.

Passwords		
Menu Name	Menu Number	Description
Passwords	5.0	Press Enter (↵) to access this menu.
Master	5.1	Enter a new 4-digit master password . Once the digits are entered, the password is reset.
Operator	5.2	Enter a new 4-digit operator password . Once the digits are entered, the password is reset. Press Clear/Manual (←) to exit this menu.

Outputs		
Menu Name	Menu Number	Description
Outputs	6.0	An additional multiplexer can be used to combine the monitor outputs of multiple multiplexers to one monitor. Press Enter (↵) to access this menu.
Switch Dev	6.1	Switch Device – use the + and – keys to select the type of multiplexer used to combine the monitor outputs. Press Clear/Manual (←) to exit this menu.
Address	6.2	Enter the address of the output using the number keys or the + and – keys (001 to 255).

4.3 MENUS, CONTINUED

General		
Menu Name	Menu Number	Description
General	7.0	Used to deactivate the buzzer or set language options. Press Enter (↵) to access this menu.
Buzzer	7.1	Use the + and – keys to toggle the buzzer ON or OFF. Press Clear/Manual (←) to exit this menu.
Language	7.2	Menus are currently only available in English. Use the + and – keys to scroll through the language options. Press Clear/Manual (←) to exit this menu.

Exit		
Menu Name	Menu Number	Description
Exit	8.0	Press Enter (↵) to exit the Setup Mode. You can also press the System Menu key or the Clear/Manual (←) key to exit the system menu.

Notes:

SECTION 5: STANDALONE MODE HEGS5000

5.1 OPERATION

When the HEGS5000 Controller is in Standalone Mode, a user can control and program KD6/HD6 PTZ cameras. The KD6/HD6 PTZ cameras must be defined in the HEGS5000 as defined in Section 2.3.1 and 4.3.

There are two overlays, English text version and Icon version, for the standalone mode.

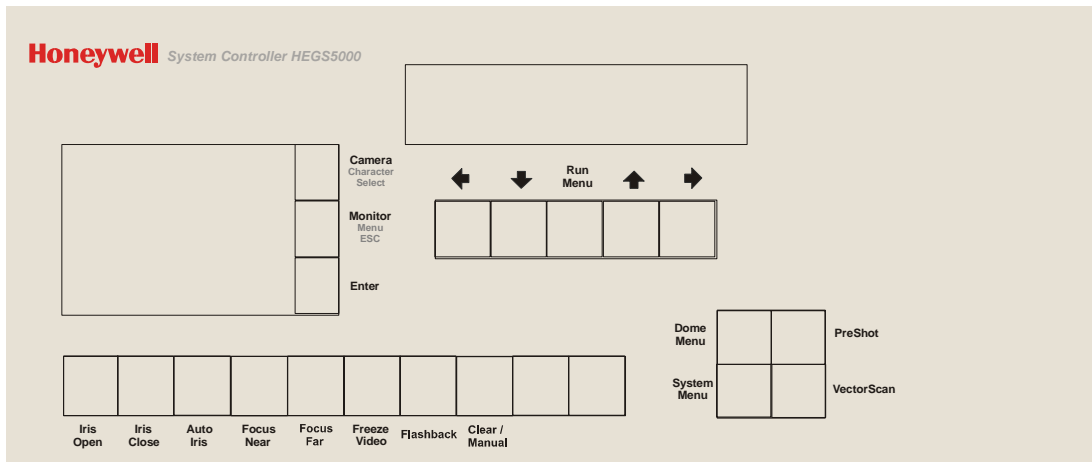

Figure 5. HEGS5000 English Text Overlay

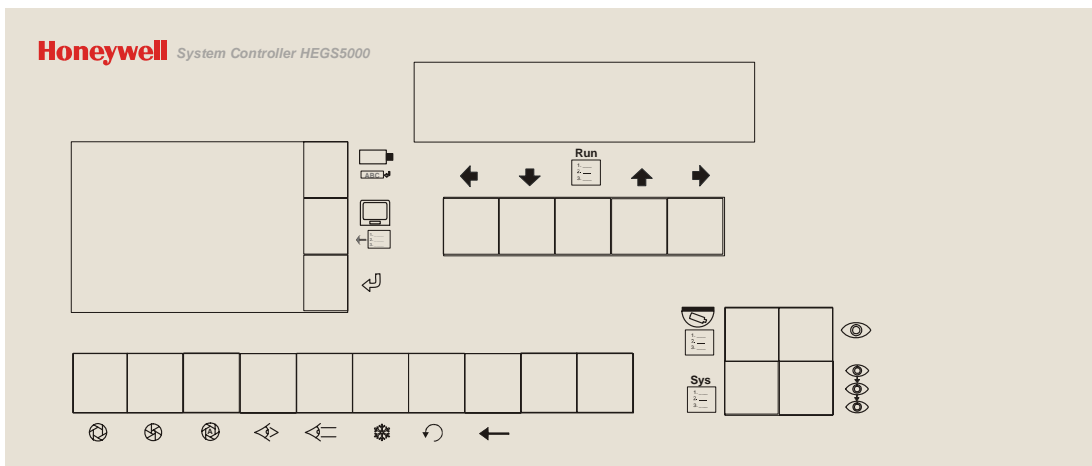





Figure 6. HEGS5000 Icon Overlay

All instructions are given using the text overlay with the Icon overlay in parenthesis.

Note: The **Monitor** Key () is not used in the standalone mode except as a **Menu Esc** () key. All cameras must have dedicated monitors.

5.1.1 Camera (KD6/HD6) Selection

To select a camera for control:

1. Enter the **camera number** (1-256) using the numeric keypad.
2. Press the **Camera** () key.

5.1.2 Manual Control



















Table 1. Manual Control	
Function	Description
Pan/Tilt	Use the joystick to control (pan and tilt) the camera. Move the joystick up and down for tilt functions and left and right for pan functions.
Zoom	Rotate the joystick knob clockwise/counterclockwise for zoom in/out functions.
Iris	<p>Press the Auto Iris () key to place the lens in auto iris mode</p> <p>Press the Iris Open () key to manually open the lens iris.</p> <p>Press the Iris Close () key to manually close the lens iris.</p>
Focus	Press the Focus Near () or Focus Far () keys to manually focus the lens.
Run Menu ()	<p>The Run Menu () key (below the LCD display) is used to control certain features of the KD6/HD6 PTZ camera. Press Run Menu () continuously to scroll between available options. When the desired option is displayed on the controller's LCD, press Enter () to select.</p> <ul style="list-style-type: none"> ▪ Nightshot – press Enter () to toggle on/off. A message (Nightshot On or Nightshot Off) is displayed on the monitor where the PTZ video is viewed. ▪ Backlight On/Off – press Enter () to toggle on/off. A message (Backlight Compensation On or Backlight Compensation Off) is displayed on the monitor where the PTZ video is viewed. ▪ Run Tour – press Enter () > then tour # (1-3) > then Enter (). The tour must be programmed for it to run. Refer to section 5.2.9 for programming tours. ▪ Find Home – Press Enter () to send selected KD6/HD6 to home position. ▪ Quick Prg Preset – Position PTZ of KD6/HD6 > Press Enter () > then Preshot # (000-099) > Press Enter (). The current scene is stored with the selected Preshot #. ▪ Log Out – Press Enter () to log out; press Menu Esc () to cancel log out

Table 1. Manual Control, Continued	
Function	Description
Freeze Video (❄️)	Press the Freeze Video (❄️) key to freeze or unfreeze the current video scene. When the video is frozen, an asterisk is displayed in the bottom left corner of the display and the camera remains on the current scene until the operator unfreezes the video. An operator can manually control the camera or send the camera to a PreShot, but the video display does not change. When the video is unfrozen, the scene the camera is viewing is outputted on the video signal.
Flashback (↶)	The flashback function provides the user with the ability to quickly return to a scene of interest. Each time the flashback function is invoked, the scan returns to the scene viewed immediately prior to when the flashback was invoked previously. Refer to the KD6/HD6 User Manual for more detailed operation.
Clear/Manual (←)	Sends the Esc command to the KD6/HD6. Press to exit on-screen setup menus. After all menus have been exited, you can press Clear/Manual (←) 4 times to reset the KD6/HD6 through the software.

5.2 KD6/HD6 DOME MENUS

The HEGS5000 controller can be used to program KD6/HD6 PTZ units.



1. Press the **Dome Menu** () key. The following is displayed on the LCD screen.

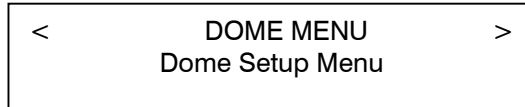







2. Press the **+** or **-** keys to scroll through the available menus. When the desired menu is displayed, press **Enter** () to access it.



3. To exit, press the **Dome Menu** () key.

4. To exit a menu on the LCD controller, press the **Clear/Manual** () key.

 Table 2. DOME MENU () Key – Access/Exit Dome Menus	
Menu	Description
Dome Setup Menu	Accesses the on-screen setup menus for the KD6/HD6. <ul style="list-style-type: none"> ▪ Language Selection for on-screen menus ▪ Display Options ▪ Control Options ▪ Diagnostic Options ▪ Camera Options ▪ Function Programming (VectorScans and Tours)
PreShot Menu	Accesses the KD6/HD6 PreShot menu. Use +/- keys to scroll through menu options: <ul style="list-style-type: none"> ▪ Program PreShots (0-99); PreShot 99 reserved for controlling nightshot mode if feature available on dome camera. ▪ List Programmed PreShots
VectorScan Menu	Accesses the KD6/HD6 VectorScan menu. Use +/- keys to scroll through menu options: <ul style="list-style-type: none"> ▪ Program VectorScans (0-9) ▪ List Programmed VectorScans ▪ List Contents of a Specific VectorScan ▪ Run Once
Sector/Priv Menu	Accesses the KD6/HD6 Sector ID/Privacy Zone menu. Use +/- keys to scroll through menu options: <ul style="list-style-type: none"> ▪ Program Sector IDs (1-16)/Privacy Zones ▪ List Programmed Sector IDs ▪ Program Privacy Zones (10 – Sony camera; 2- Hitachi camera)

 Table 2. DOME MENU () Key – Access/Exit Dome Menus, Continued	
Menu	Description
Tour Menu	Accesses the KD6/HD6 Tour menu. Use +/- keys to scroll through menu options: <ul style="list-style-type: none"> ▪ Program Tour (1-3) ▪ Run Tour (1-3) ▪ Delete Tour (1-3)
Keys	Description
	<ul style="list-style-type: none"> ▪ Position the cursor when entering text ▪ Move to the previous/next field within a menu ▪ Move text left or right on the screen within a KD6/HD6 menu
	Move text up or down on the screen within a KD6/HD6 menu
+/-	Scroll through the characters on the controller LCD
Character Select 	Sends the character displayed on the controller LCD to the KD6/HD6.
Enter ()	Selects a menu or accepts text in a field.

5.2.1 Dome Setup Menu

To access the KD6/HD6 menu, you must be logged in as a **Master** user.

1. Press the **Dome Menu** () key. The following is displayed on the LCD screen.

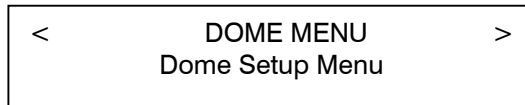

2. Press **Enter** () to access the Dome Setup Menu.

The controller LCD display changes to:

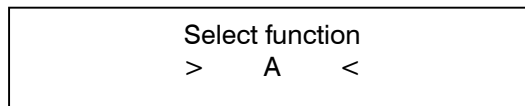

5.2.1 Dome Setup Menu, Continued

The on-screen menu is displayed on the monitor where the KD6/HD6 video is viewed.

To access a menu, press the number beside the option.

The numbers either toggle between the available choices or call up another menu.

Refer to the KD6/HD6 user manual for detailed instructions.

```
UltraDome HD6i
518584-2980 Rev X
1 Language .....English
2 Display Options
3 Control Options
4 Diagnostic Options
5 Camera Options
6 Function Programming
ESC TO EXIT
```

Use the **Clear/Manual** (←) key to exit any KD6/HD6 menu. Once out of the on-screen monitor menus, press the **Menu Esc** (← ) key to exit the menus on the LCD display and return to controlling the camera.

5.2.2 Program PreShot



There are two methods for programming and saving PreShots. The first method quickly saves the current camera scene and assigns a predefined title. For example, PreShot 1 is titled PS1, PreShot 2 is titled PS2, etc. The second method allows the user to program a 24-character title.

Note: Operators may program PreShots 0-10. To program PreShots 11-98, you must log in as a Master user.

Program PreShot Method 1 (Default title)

1. Position the camera (pan, tilt) and the lens (zoom, focus, iris) to the desired scene.



Run

2. Press the **Run Menu** () key until **Quick Prg Preset** is displayed on the LCD then press **Enter** ().
3. Enter the desired PreShot # (**0-99**) and Press **Enter** (). The current PTZ position and lens setting are saved for the PreShot # entered.

Example: To save PreShot 5 with default title PS5.

1. Position the camera and lens.



Run

2. Press the **Run Menu** () key until **Quick Prg Preset** is displayed.
3. Press the **Enter** () key.
4. Press the **5** key.
4. Press the **Enter** () key.

The current KD6/HD6 scene is saved as PreShot 5 with title PS5.

Program PreShot Method 2 (User-defined Title)





1. Press the **Dome Menu** () key.
2. Press the + or - key until **PreShot Menu** is displayed.
3. Press the **Enter** () key.
5. Press the + or - key until **Program** is displayed.

5.2.2 Program PreShot, Continued

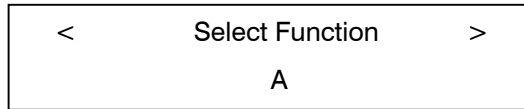

6. Press the **Enter** () key. The following is displayed on the controller's LCD.



Follow the on-screen prompts that appear on the monitor where the KD6/HD6 video is viewed.



7. Enter the PreShot number (**0-99**) using the numeric keypad and press the **Enter** () key. If the selected PreShot# has already been programmed the PreShot title is displayed. To accept the existing title, press Enter (). To change the current title proceed to step 8.

Note: PreShot 99 is reserved for controlling the Nightshot mode if this feature is available on the dome and cannot be programmed. For domes without the nightshot feature, PreShot 99 can be programmed.

8. Enter the desired **title** by performing the following steps.
- Press the **+ or –** key until the desired character is displayed on the LCD screen, and then press **Character Select** (). The controller sends the character to the KD6/HD6.
 - Continue selecting characters and pressing **Character Select** () until the desired title is displayed on the monitor.
 - Press **Enter** (). The following options are displayed on the monitor:











C to Change name location	Press + or – key until C is displayed on the LCD and press Char Select. Use the up or down arrow keys to reposition the PreShot title on the monitor screen.
E to Edit PreShot	Press + or – key until E is displayed on LCD and press Char Select. Reposition the PTZ and/or change the lens settings, then repeat steps 6 and 7.
D to Delete PreShot	Press + or – key until D is displayed on LCD and press Char Select. The PreShot # entered in step 6 is deleted.
S to Save PreShot	Press + or – key until S is displayed on LCD and press Char Select. The current PTZ and lens (focus and iris) settings are saved for the PreShot # entered in step 6.
N to Save Name only	Press + or – key until E is displayed on LCD and press Char Select. This option is used for renaming PreShots. The title only entered in step 7 is saved for the PreShot # entered. The current PTZ and iris settings of the dome are not saved.

5.2.2 Program PreShot, Continued









9. Press the + or – key until the **character** for the desired action is displayed on the LCD and Press **Character Select** (). Refer to the above table for the required steps after selecting a character.
10. Program another PreShot by **repeating steps 7 through 9** or press **Clear/Manual** () to exit the PreShot Programming menu.

11. Press **Dome Menu** () or press **Menu Esc** () three times to exit the menu on the controller LCD.

Example: Program PreShot 1 titled Front Door in Camera 1

1. Select camera 1.
 - a. Press the **1** key
 - b. Press the **Camera** () key
2. Position camera 1 to the desired PreShot position (pan, tilt, zoom, focus, iris)
3. Press the **Dome Menu** () key.
4. Press + or – until **PreShot Menu** is displayed on the LCD and press **Enter** ()
5. Press + or – until **Program** is displayed on the LCD and press **Enter** ()
6. Press the **1** key and press **Enter** ()
7. Program the title.
 - a. Press the +/- key until upper case **F** is displayed on the controller LCD and then press **Character Select** ()
 - b. Press the +/- key until lower case **r** is displayed on the controller LCD and then press **Character Select** ()
 - c. Press the +/- key until lower case **o** is displayed on the controller LCD and then press **Character Select** ()
 - d. Press the +/- key until lower case **n** is displayed on the controller LCD and then press **Character Select** ()
 - e. Press the +/- key until lower case **t** is displayed on the controller LCD and then press **Character Select** ()
 - f. Press the +/- key until **Space** is displayed on the controller LCD and then press **Character Select** ()

5.2.2 Program PreShot, Continued

- g. Press the +/- key until upper case **D** is displayed on the controller LCD and then press **Character Select** ().
 - h. Press the +/- key until lower case **o** is displayed on the controller LCD and then press **Character Select** ().
 - i. Press the +/- key until lower case **o** is displayed on the controller LCD and then press **Character Select** ().
 - j. Press the +/- key until lower case **r** is displayed on the controller LCD and then press **Character Select** ().
 - k. Press the **Enter** () key.
8. Press the +/- key until upper/lower case **S** is displayed on the controller LCD and then press **Character Select** ().
 9. Program another PreShot or press **Clear/Manual** () to exit.
10. Press **Dome Menu** () or press **Menu Esc** () three times to exit the menus on the controller LCD.

5.2.3 Recall PreShot

The first 10 PreShots (Views) are available as scratchpad PreShots. These can be saved and recalled by the operator. PreShots (Views) 11-99 can only be recalled by the operator and not saved.

To recall a PreShot or view, enter the **PreShot number (0-99)** using the numeric keypad and press the **PreShot** () key.



Example: To recall PreShot 11:

1. Press **1**
2. Press **1** again.
3. Press **PreShot** (.



5.2.4 List Programmed PreShots

To view a listing of the programmed PreShots, perform the following steps. This display cannot be edited; it is for viewing purposes only.





1. Press **Dome Menu** ().
2. Press + or – until **PreShot Menu** is displayed on the controller LCD.
3. Press **Enter** ().
4. Press + or – until **List** is displayed on the controller LCD.
5. Press **Enter** ().

A list of the existing PreShots is displayed on the monitor (where the KD6/HD6 video can be viewed).

The controller LCD display shows the command Page Down. Press **Enter** () to view more pages of the listing. When you have reached the end of the listing, End of Directory is displayed on the monitor. To go back to the first page of the listing press **Enter** ().

6. When finished viewing the PreShot listing, press the **Clear/Manual** () key.





7. To exit the menu on the LCD controller, press **Dome Menu** () or press the **Menu Esc** () key.





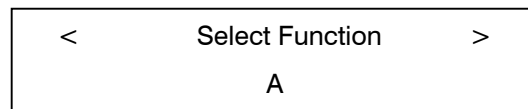

5.2.5 Programming a VectorScan

Note: VectorScan Programming is only available to Master users.



1. Press the **Dome Menu** () key.
2. Press the + **or** - key until **VectorScan Menu** is displayed.
3. Press the **Enter** () key.
5. Press the + **or** - key until **Program** is displayed.
6. Press the **Enter** () key. Follow the on-screen prompts that appear on the monitor where the KD6/HD6 video is viewed.





7. Enter the VectorScan number (**0-9**) using the numeric keypad and press the **Enter** () key. If the selected VectorScan# has already been programmed the title is displayed and the programmed PreShots are displayed. To accept the existing title, press **Enter** (). To change the current title proceed to step 8.
8. Enter the desired title by performing the following steps.
 - a. Press the + **or** - key until the desired character is displayed on the LCD screen, and then press **Character Select** (). The controller sends the character to the KD6/HD6.
 - b. Continue selecting characters and press **Character Select** () until the desired title is displayed on the monitor.
 - c. Press **Enter** (). The cursor moves to the first PreShot field.
9. Enter the first PreShot Number (**0-99**) using the numeric keys. **Note:** If the cursor doesn't automatically move to the Velocity field, press the right arrow key () below the controller's LCD.
10. Enter the velocity from **1 to 400** (degrees per second) in the VELOCITY column of the 0 row. If the cursor doesn't automatically move to the Velocity field, press the right arrow key () below the controller's LCD.
11. Type the dwell time from **0-99** seconds.
12. Continue entering PreShots (up to a total of 64) by repeating steps 9, 10, and 11.

5.2.5 Programming a VectorScan, Continued

13. Press **Enter** () when finished adding PreShots. The following commands are displayed on the bottom of the monitor.

VectorScan Commands	
E = Edit	Press + or – key until E is displayed on LCD and press Char Select. Reposition the PTZ and/or change the lens settings, then repeat steps 6 and 7.
D = Delete	Press + or – key until D is displayed on LCD and press Char Select. The PreShot # entered in step 6 is deleted.
S = Save	Press + or – key until S is displayed on LCD and press Char Select. The current PTZ and lens (focus and iris) settings are saved for the PreShot # entered in step 6.

14. Press + or – until the character (**E, D, or S**) for the desired action is displayed on the controller LCD and then press **Character Select** () .
15. Program another VectorScan or press **Clear/Manual** () to exit the PreShot Programming menu.

5.2.6 Run VectorScan

To run a programmed VectorScan continuously:

1. Enter the VectorScan # (**0-9**) using the numeric keys.







2. Press the **VectorScan** () key.

The VectorScan runs continuously until the KD6/HD6 receives another command.

To run a programmed VectorScan one time through the programmed PreShots:





1. Press the **Dome Menu** () key.
2. Press + or – until **VectorScan Menu** is displayed and press **Enter** () .
3. Press + or – until **Run Once** is displayed on the LCD and press **Enter** () .
3. Enter the VectorScan # (**0-9**) using the numeric keys.
4. Press **Enter** () .

The dome goes to each programmed PreShot at the velocity programmed and for the dwell time specified and then stops.

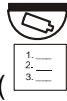

5.2.7 List VectorScans

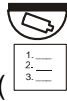
To view a list of the programmed VectorScans:





1. Press the **Dome Menu** () key.
2. Press + or – until **VectorScan Menu** is displayed on the LCD and press **Enter** ().
3. Press + or – until **List** is displayed on the LCD and press **Enter** ().

The VectorScan list, including number and title, is displayed on the monitor (where the video from the KD6/HD6 can be viewed).

The controller LCD display shows the command Page Down. Press **Enter** () to view more pages of the listing. When you have reached the end of the listing, End of Directory is displayed on the monitor. To go back to the first page of the listing press **Enter** ().

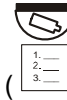
4. When finished viewing the VectorScan listing, press the **Clear/Manual** () key.

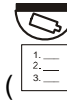



5. To exit the menu on the LCD controller, press **Dome Menu** () or press the **Menu Esc** () key.

5.2.8 List VectorScan Contents

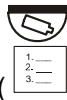
To view a list of the programmed VectorScans:

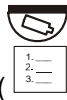



1. Press the **Dome Menu** () key.
2. Press + or – until **VectorScan Menu** is displayed on the LCD and press **Enter** ().
3. Press + or – until **Vscan Contents** is displayed on the LCD and press **Enter** ().
4. Enter the VectorScan number (**0-9**) you want to view.

The contents of the selected VectorScan is displayed on the monitor where the KD6/HD6 video is viewed.



Use the **↑** and **↓** keys to scroll up and down through the contents.

5.2.8 List VectorScan Contents, Continued

5. When finished viewing the VectorScan contents, press **Enter** () .
6. To exit the menu on the LCD controller, press **Dome Menu** () or press the **Menu Esc** () key until the LCD display is cleared of all menus.

5.2.9 Program a Tour

Note: Tour Programming is only available to Master users.





1. Press the **Dome Menu** () key.
2. Press + or – until **Tour Menu** is displayed on the controller LCD.
3. Press **Enter** () .
4. Press + or – until **Program** is displayed on the controller LCD.
5. Enter the **Tour number (1-3)** you desire to program using the numeric keypad on the controller and press **Enter** () . The controller LCD displays:

< Tour Menu >
Tour Prgm Stop

6. The scan will begin to count down from 120 to 0 seconds. Perform the desired pan, tilt, and zoom commands until the unit times out. The scan saves all commands as the operator performs them. To end the programming before the scan times out, press **Enter** (Tour Prgm Stop) or press the **Clear/Manual** () key.





A message PROGRAM PTZ TOUR COMPLETE is displayed on the monitor.

5.2.10 Run a Tour

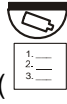
1. Press the **Dome Menu** () key.
2. Press + or – until **Tour Menu** is displayed and press **Enter** () .
3. Press + or – until **Run** is displayed and press **Enter** () .
4. Enter the desired tour # (**1-3**) using the numeric keys and press **Enter** () . The programmed tour begins and runs continuously until the KD6/HD6 receives another command.

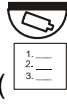
5.2.11 Delete a Tour







1. Press the **Dome Menu** () key.
2. Press + or - until **Tour Menu** is displayed.
3. Press **Enter** ().
4. Press + or - until **Delete** is displayed.
5. Press **Enter** ().
6. Enter the desired tour # (**1-3**) using the numeric keys.
7. Press **Enter** ().

5.2.12 Programming Sector IDs

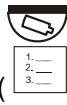

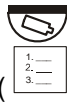
Sector IDs are used for labeling specific areas that the PTZ camera views. Whenever a PTZ camera is under manual control and it is viewing a programmed sector, the name given that sector is added to the video signal.

Note: The camera ID display must be enabled. When an operator is viewing the monitor or a video recorder is recording a specific dome, this labeling provides a quick reference for the area being displayed. Up to 16 Sector IDs can be programmed for each Scan Unit.



1. Press the **Dome Menu** () key.
2. Press + or - until **Sector/Priv Menu** is displayed.
3. Press **Enter** ().
4. Press + or - until **Program** is displayed.
5. Press **Enter** ().
6. Enter the desired sector number (**0-15**) to program.
7. Press **Enter** ().

5.2.12 Programming Sector IDs, continued

8. Enter the Sector title (up to 24 characters)
 - a. Press the **+** or **-** key until the desired character is displayed on the LCD screen, and then press **Character Select** (). The controller sends the character to the KD6/HD6.
 - b. Continue selecting characters and press **Character Select** () until the desired title is displayed on the monitor.
 - c. Press **Enter** ().

The following options are displayed on the monitor:

E to Edit Sector	Press + or - key until E is displayed on LCD and press Char Select. Repeat step 8.
D to Delete Sector	Press + or - key until D is displayed on LCD and press Char Select. The Sector # entered in step 6 is deleted.
S to Save Sector Coord.	Press + or - until S is displayed on LCD and press Char Select. Follow instructions in step 9.
N to Save Name only	Press + or - key until N is displayed on LCD and press Char Select. This option is used for renaming Sector IDs. The title only entered in step 8 is saved for the Sector # entered. The current sector coordinates are not changed.

9. Press **+** or **-** until the character for the desired action is displayed on the LCD and then press **Character Select** ().

To **save Sector coordinates**, press **+** or **-** until **S** is displayed on the LCD and press **Character Select** (). Refer to the diagram below for programming coordinates.

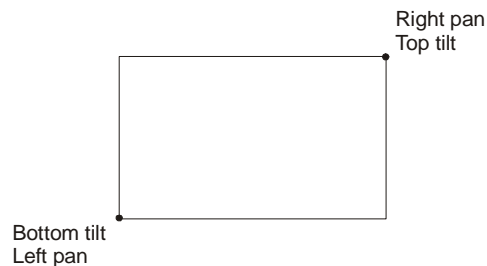

- a. Using the joystick, move the PTZ so the lower left corner of the sector is centered on the monitor, then press **Enter** ().

5.2.12 Programming Sector IDs, continued



- b. Using the joystick, move the PTZ so the upper right corner of the sector is centered on the monitor, and then press **Enter** ()

Factory set password

If the upper right tilt position is below the lower left tilt position, the message "Illegal Tilt Direction" is displayed. Readjust the tilt position until the message disappears or press Clear/Manual to cancel the operation and return to manual operation.

10. Repeat steps 6-9 to continue programming sectors or press **Clear/Manual** () to return to manual operation.



11. Press **Dome Menu** () or **Menu Esc** () to exit the Dome Menu on the LCD display.





5.2.13 Programming/Editing/Deleting Privacy Zones

All privacy zone programming is password protected. The password is user programmable up to 14 alphanumeric characters. If the KD6/HD6 has a Sony camera, up to 10 (0-9) privacy zones can be programmed with a unique 24-character alphanumeric title. If the KD6/HD6 has an Hitachi camera, 2 privacy zones can be programmed







5.2.13.1 Programming/Editing/Deleting Privacy Zones, Sony Camera

To program privacy zones in a KD6/HD6 with a Sony camera:



1. Press the **Dome Menu** () key.
2. Press + or - until **Sector/Priv Menu** is displayed.
3. Press **Enter** ()
4. Press + or - until **Program** is displayed.
5. Press **Enter** ()
6. Press + or - until **P** is displayed on the controller LCD.
7. Press **Enter** ()
8. Enter the password. (The factory set password is blank. Just press **Enter** () to submit a blank password.)

5.2.13.1 Programming/Editing/Deleting Privacy Zones, Sony Camera, Continued

- a. Press the + or – key until the desired character is displayed on the LCD screen, and then press **Character Select** (). The controller sends the character to the KD6/HD6.
 - b. Continue selecting characters and press **Character Select** () until all the characters in the password have been sent to the KD6/HD6. The characters will appear as asterisks (*) on the monitor display for security purposes.
 - c. Press **Enter** ().
9. Enter the desired privacy number (**0-9**) to program.
10. Press **Enter** ().
11. Enter the Privacy title (up to 24 characters)
- a. Press the + or – key until the desired character is displayed on the LCD screen, and then press **Character Select** (). The controller sends the character to the KD6/HD6.
 - b. Continue selecting characters and press **Character Select** () until the desired title is displayed on the monitor.
 - c. Press **Enter** ().

The following options are displayed on the monitor:



E to Edit the Title	Press + or – key until E is displayed on LCD and press Char Select. Repeat step 10.
D to Delete Zone Coordinates	Press + or – key until D is displayed on LCD and press Char Select. The coordinates for the Privacy # entered in step 9 is deleted.
S to Program Zone Coord.	Press + or – until S is displayed on LCD and press Char Select. Refer to the instructions below in step 12.
N to Save privacy title only	Press + or – key until N is displayed on LCD and press Char Select. This option is used for renaming Privacy Zone Titles. The title only entered in step 11 is saved for the Privacy # entered. The programmed privacy coordinates are not changed.

5.2.13.1 Programming/Editing/Deleting Privacy Zones, Sony Camera, Continued

12. Press + or – until the character for the desired action is displayed on the LCD and then press **Character Select** ().

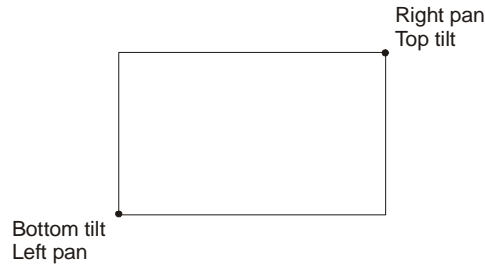
To **save Privacy coordinates**, press + or – until **S** is displayed on the LCD and press **Character Select** (). Refer to the diagram below for programming coordinates.



- a. Using the joystick, move the PTZ so the lower left corner of the privacy zone is on the lower left corner of the monitor, and then press **Enter** ().
- b. Using the joystick, move the PTZ so the upper right corner of the privacy zone is on the upper right corner of the monitor, and then press **Enter** ().

If the upper right tilt position is below the lower left tilt position, the message "Illegal Tilt Direction" is displayed. Readjust the tilt position until the message disappears or press Clear/Manual to cancel the operation and return to manual operation.

The privacy zone is programmed for all points between the selected coordinates as shown in the above diagram.

13. Repeat steps 9-12 to continue programming privacy zones or press Clear/Manual to return to manual operation.













14. Press **Dome Menu** () to exit the Dome Menu.

5.2.13.2 Programming/Editing/Deleting Privacy Zones, Hitachi Camera

To program privacy zones in a KD6/HD6 with a Sony camera:



1. Press the **Dome Menu** () key.
2. Press + or - until **Sector/Priv Menu** is displayed.
3. Press **Enter** ().
4. Press + or - until **Program** is displayed.
5. Press **Enter** ().
6. Press + or - until **P** is displayed on the controller LCD.
7. Press **Enter** ().
8. Enter the **password**. (The factory set password is blank. Just press Enter () to submit a blank password.)
 - a. Press the + or - key until the desired character is displayed on the LCD screen, and then press **Character Select** (). The controller sends the character to the KD6/HD6.
 - b. Continue selecting characters and press **Character Select** () until all the characters in the password have been sent to the KD6/HD6. The characters will appear as astericks (*) on the monitor display for security purposes.
 - c. Press **Enter** ().
9. Enter the desired privacy number (**1 or 2**) to program.
10. Press **Enter** ().
11. Enter the Privacy **title** (up to 24 characters)
 - a. Press the + or - key until the desired character is displayed on the LCD screen, and then press **Character Select** (). The controller sends the character to the KD6/HD6.
 - b. Continue selecting characters and pressing **Character Select** () until the desired title is displayed on the monitor.

Factory set password

5.2.13.2 Programming/Editing/Deleting Privacy Zones, Hitachi Camera, Continued



- c. Press **Enter** (.

The following options are displayed on the monitor:

E to Edit the Title	Press + or – key until E is displayed on LCD and press Char Select. Repeat step 10.
D to Delete Zone Coordinates	Press + or – key until D is displayed on LCD and press Char Select. The coordinates for the Privacy # entered in step 9 is deleted.
S to Program Zone Coordinates	Press + or – until S is displayed on LCD and press Char Select. Refer to the instructions below in step 13.
N to Save privacy title only	Press + or – key until N is displayed on LCD and press Char Select. This option is used for renaming Privacy Zone Titles. The title only entered in step 11 is saved for the Privacy # entered. The programmed privacy coordinates are not changed.

12. Press + or – until the character for the desired action is displayed on the LCD and then press **Character Select** (.
13. If you selected **S** to program zone coordinates, use the joystick to move the block over the area to be hidden. Use the left, right, up, and down arrows below the LCD to increase or decrease the width and height, respectively, of the privacy block.

Note: the zoom function is disabled while programming a privacy zone.







14. Press **Enter** (.
15. Repeat steps 9-14 to continue programming privacy zones or press Clear/Manual () twice to return to manual operation.



16. Press **Dome Menu** () to exit menus on the LCD.

5.2.13.3 Changing the Privacy Zone Password



1. Press the **Dome Menu** () key.
2. Press + **or** – until **Sector/Priv Menu** is displayed on the LCD.
3. Press **Enter** ().
4. Press + **or** – until **P** is displayed on the LCD and press **Char Select**.
5. Enter the current **password**.
 - a. Press the + **or** – key until the desired character is displayed on the LCD screen, and then press **Character Select** (). The controller sends the character to the KD6/HD6.
 - b. Continue selecting characters and pressing **Character Select** () until all the characters in the password have been sent to the KD6/HD6. The characters will appear as astericks (*) on the monitor display for security purposes.
 - c. Press **Enter** ().
6. Press + **or** – until **P** is displayed on the controller LCD and press **Character Select** ().
7. Enter the **new password**. Refer to step 5, steps a through c, for entering passwords.
8. Re-enter the **new password** for verification. Refer to step 5, steps a through c. If you enter a different password the second time, an invalid message is displayed and you must start again.
9. After programming the password, you can program a privacy zone or press **Clear/Manual** () twice to exit programming.

5.2.14 Nightshot Mode

The nightshot feature is only available on KD6/HD6 models with the following cameras:

843216-1011	Sony Color NTSC w/4.1-73.8mm, IR
843216-1013	Sony Color PAL w/4.1-73.8mm, IR
843216-0984	Hitachi Color NTSC Camera w/3.6- 82.8mm, IR
843216-0985	Hitachi Color PAL Camera w/3.6-82.8mm, IR

Run

To toggle between standard operation and nightshot, press the **Run Menu** ()

continuously until **Nightshot** is displayed and press **Enter** (). A message (Nightshot On or Nightshot Off) is displayed on the monitor where the PTZ video is viewed.

SECTION 6: MUX MODE OPERATION HEGS5001

6.1 INTRODUCTION

In the MUX mode of operation, the HEGS5001 is capable of controlling multiplexers, VCRs, and KD6/HD6 PTZ cameras. Refer to Section 5 for information on controlling the KD6/HD6 PTZ cameras.

There are two overlays, English Text version and Icon Version, for MUX mode of operation.

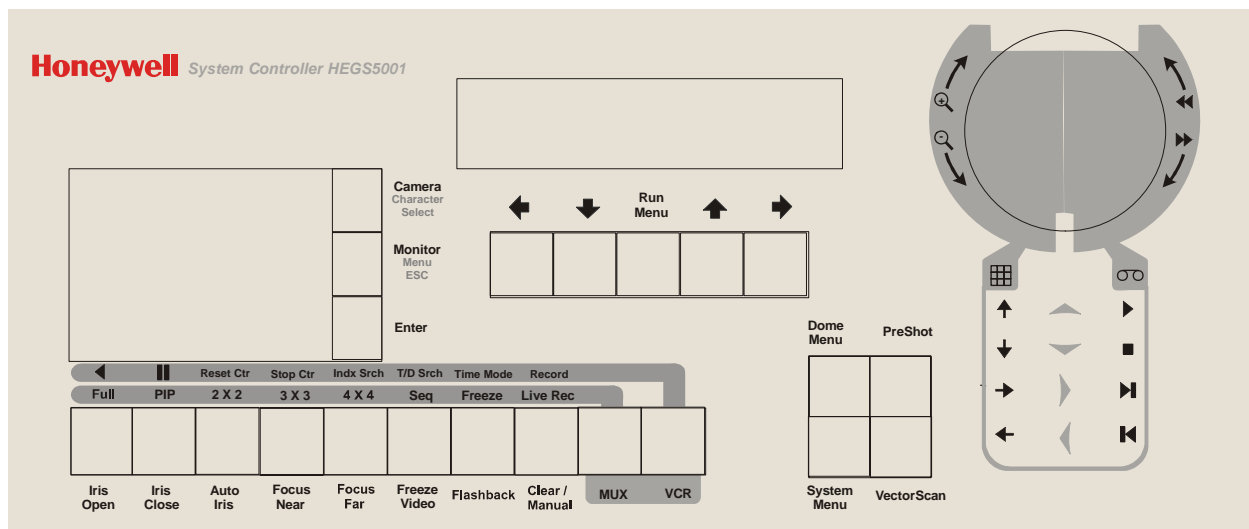

Figure 7. MUX Mode English Text Version

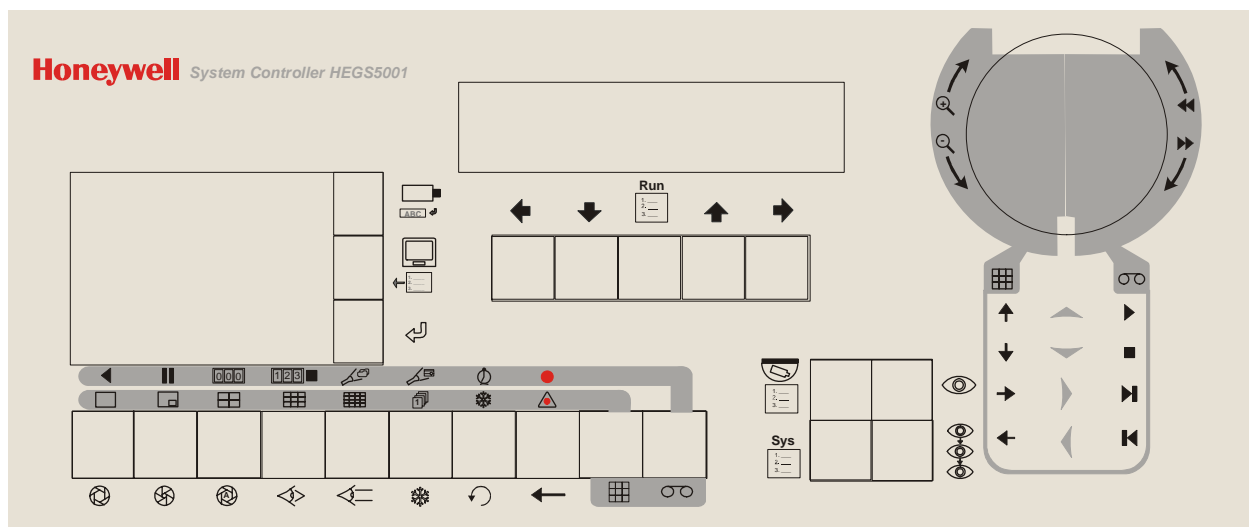

Figure 8. MUX Mode Icon Version

6.1 INTRODUCTION, CONTINUED

The initial display after a user logs on the controller is shown below.

<Spot01	Cam001>
---------	---------

The operator has control of camera 1 and Spot Monitor 1 (multiplexer 1).

Tip: Press + and – to select the next or previous camera.

Tip: Press **Monitor** () followed by + or - to select the next or previous spot monitor.

6.2 SPOT MONITOR OPERATION

The Spot monitor operates in two modes: Absolute and Relative. The HEGS5001 is in absolute mode as shown below by default.

<Spot01	Cam001>
---------	---------

To toggle between Absolute and Relative modes, press the CAMERA key twice quickly.

Camera () Camera ()

The SPOT still shows the multiplexer number while the CAM shows the input of that multiplexer with an asterisk in front of the number.

<Spot01	Cam*01>
---------	---------

6.2.1 Absolute Mode

In absolute mode, the camera number is displayed and selected by a number in the range 001 to 256. Cameras 001 to 016 are from the first multiplexer, 017 to 032 the second, and so on. The multiplexer to be controlled is automatically calculated and indicated by the number after SPOT. Absolute mode is indicated by displaying the camera number as 3 digits (i.e., 012).

Example: Routing a camera to a spot monitor. Example camera 12.

Camera () 12 Enter (↵) OR 12 Camera ()

<Spot01	Cam012>
---------	---------

Camera 12 is connected to Multiplexer 1 so the Spot Monitor is 01.

Routing camera 20 to a spot monitor changes the spot monitor to 02 because Camera 20 is connected to Multiplexer 2.

Camera () 20 Enter (↵) OR 20 Camera ()

<Spot02	Cam020>
---------	---------

6.2.2 Relative Mode

In this mode the camera number is displayed and selected by a number in the range 1 to 4, 9, or 16 depending on the multiplexer size. The multiplexer selected will be the default multiplexer indicated next to SPOT. To select a camera from a different

multiplexer, use the MONITOR () key to select a different multiplexer. Relative mode is indicated by displaying the camera number with an asterisk in front of the number (i.e. *12).

Example: To route camera 1 on multiplexer 3 do the following:

Make sure the controller is in the Relative mode

Monitor () 3 Enter (↵) followed by Camera () 1 Enter (↵)







<Spot03	Cam*01 >
---------	----------

Or

3 Monitor () followed by 1 Camera ().

6.3 MULTIPLEXER CONTROL

The HEGS5001 controller sends basic commands to the multiplexer to simulate pressing the buttons on the front panel of the multiplexer. Refer to the Multiplexer User Manual for details on the operation of the multiplexer.

ICON	KEY	DESCRIPTION
	MUX	Press once to send a single multiplexer command (LED will flash). Press twice to lock the controller in multiplexer mode. A steady LED indicates the controller is locked in multiplexer mode. To exit the Multiplexer mode, press the MUX () key
	+/-	When in multiplexer mode, press + or – to scroll through the available options on the controller LCD. Press Enter when the desired option is displayed. <ul style="list-style-type: none"> ▪ Select – Select a multiplexer (001-016) ▪ Review – VCR Review mode ▪ Zoom – Access/Exit the multiplexer zoom menu ▪ Set – Mimics the Set key on the multiplexer ▪ 2nd – Mimics the 2nd key on the multiplexer ▪ Menu – Access/Exit the multiplexer menu (not available on all models)
	Joystick Knob	In the multiplexer setup menu, the joystick zoom in function mimics the SET button.
	Joystick (Left, Right Up, Down)	The LEFT, RIGHT, UP, and DOWN directions of the joystick mimic the multiplexer cursor keys. The LEFT, RIGHT, UP, and DOWN directions of the joystick mimic the mouse X/Y movements. The joystick ZOOM IN function mimics the Set key or the Left Mouse Button.
	Full Screen	Places the multiplexer into full screen mode.
	Picture-in-Picture	Places the multiplexer in picture-in-picture (PIP) mode. Press again to reverse the cameras in the PIP.
	2 x 2 Display	Places the multiplexer into 2 x 2 mode. Continue pressing to view different 2x2 screens.
	3 x 3 Display	Places the multiplexer into 3 x 3 mode.
	4 x 4 Display	Places the multiplexer into 4 x 4 mode.
	Sequence	Places the multiplexer into sequence mode. Select sequence 1 or 2 from the soft menus.
	Freeze	Places the multiplexer into freeze mode.
	Live Record	Used to record a select camera

6.4 VCR CONTROL











The HEGS5001 controller sends basic commands to the VCR. Refer to the VCR User Manual for details on the operation of the VCR.

To lock the controller into the VCR mode, press the **VCR** () button twice. The LED lights to indicate that the controller is now in the VCR mode.

Use the joystick and keys 7-14 as described in Section 2.1 to control the VCR. To select a different VCR, use the Monitor () key or Press + or - to move between VCRs.

Example: To select VCR 2, press Monitor () **2** Enter () or **2** Monitor ()

To exit the VCR mode, press **VCR** ()

ICON	KEY	DESCRIPTION
	VCR	Places the controller into the VCR mode. Press once to send a single command (LED will flash). Press twice to lock in VCR mode (LED will stay lit).
	Joystick	The LEFT, RIGHT, UP, and DOWN directions of the joystick mimic the VCR tape controls UP = Play DOWN = Stop RIGHT = Frame Advance LEFT = Frame Rewind
	Rewind	Twist the joystick knob COUNTERCLOCKWISE to REWIND.
	Fast-Forward	Twist the joystick knob CLOCKWISE to FAST-FORWARD
	Reverse Play	Play tape in reverse at regular speed.
	Pause	Pause tape playback.
	Counter Reset	Reset VCR counter.
	Counter Memory Stop	Stop VCR counter to mark location for memory.
	Index Search	Allows an index number to be searched for both the forward or reverse directions.
	Time and Date Search	Allows an exact time and date to be searched for both the forward and reverse directions.
	Time Mode	Allows the time mode of the VCR to be selected when logged in as a Master user.
	Record	Activate recording on VCR.

Notes:

SECTION 7: DOWNLOADING NEW FIRMWARE TO THE HEGS5000

7.1 INTRODUCTION

New firmware for the HEGS5000 and HEGS5001 controllers can be downloaded through the RS-232 port. This is done through a simple windows program called Ultrak Code Server.

To download the latest version of the Code Server, visit the download section on the Honeywell website

(http://www.honeywellvideo.com/support/downloads/Downloads_keyboards.html).

Select Keyboards and Controllers. Locate the HEGS5000 or HEGS5001 and follow the instruction to download the Ultrak Code Server.

To download the latest version of the HEGS5000 or HEGS5001 firmware, click the latest version and select "Open." This will open Winzip and install the firmware to the default directory (C:\Program Files\Ultrak Code Server\CCTV\HEGS5000 or HEGS5001). If Code Server was installed to a different drive, select the drive prior to installing.

7.2 CONNECTING THE HEGS5000/HEGS5001 TO YOUR PC

1. Connect the HEGS5000 to COM1 or COM2 on your PC. Refer to the diagram below for correct download cable connections.

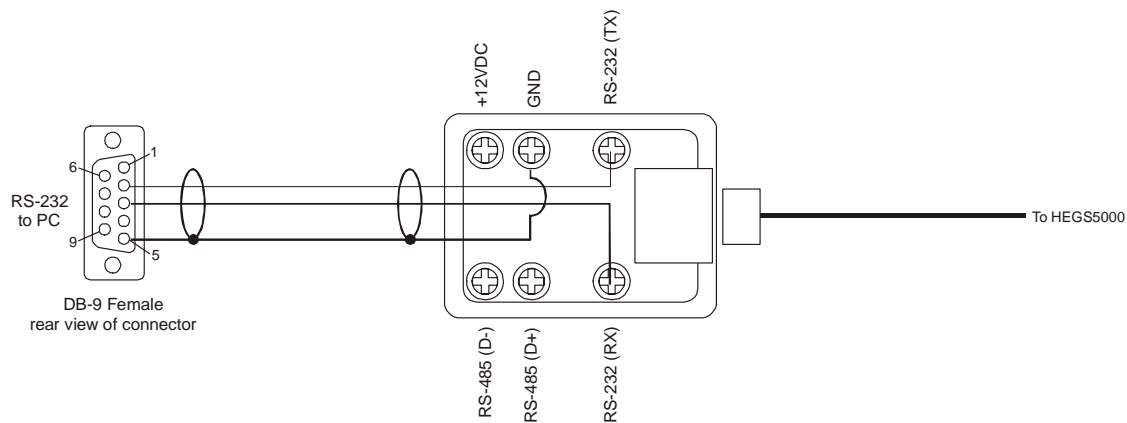

RS-232 Download cable connections

2. Disconnect power from the HEGS5000. Reconnect the power and, before the boot timer reaches zero, press 1 on the controller. This will put the controller into the download mode.
3. Enter the **Master** password (if it has not been changed the default Master password for downloading new firmware is 4991).
4. Press the LEFT (←) or RIGHT (→) arrow keys until the LCD display shows **Download Standalone Prog**

7.2 DOWNLOADING NEW FIRMWARE TO THE HEGS5000, CONTINUED

5. Press . The controller will clear the memory and, when ready to download, will display the message **Begin Download.** The HEGS5000 is now waiting for data from the PC.
6. From the START bar on your PC, Select Programs → Ultrak → Ultrak Code Server. The following window appears.

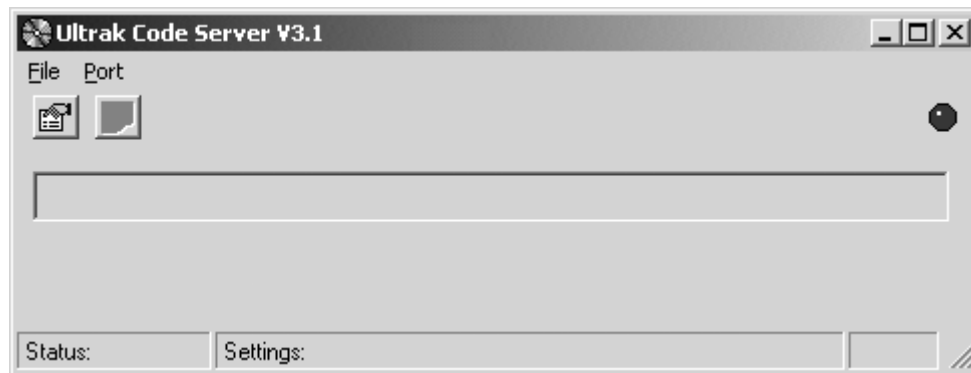



Figure 9: Ultrak Code Server Window

7. The Port Properties icon  allows you to select which serial port to use. Clicking on this icon opens the CommPort Properties window.

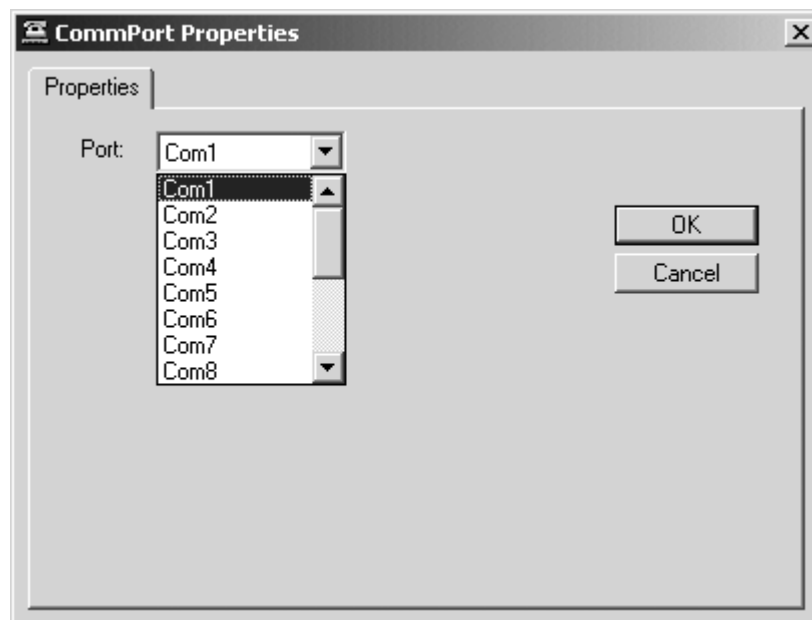

Figure 10: CommPort Properties Window

Select the serial port the download adapter is connected to and click OK.

7.2 DOWNLOADING NEW FIRMWARE TO THE HEGS5000, CONTINUED

- Click on the red dot on the right of the dialog box to enable the port.

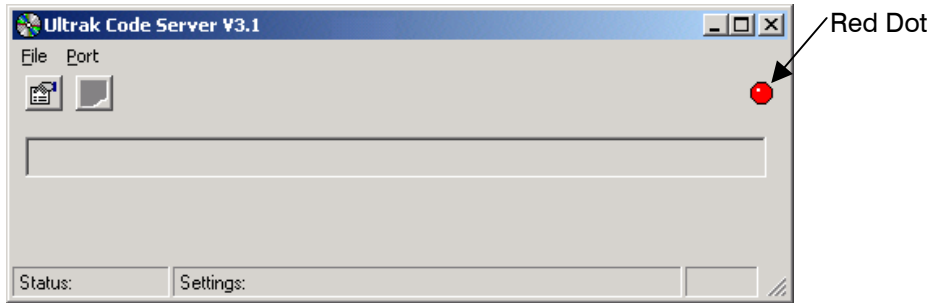



Figure 11: Enabling the CommPort

If the port is unavailable you will get an “Invalid port number” error message. This is because the port is being used by another device, usually the mouse or a modem. Click on the properties icon and select a different port.



Figure 12: Invalid Port Error

- If the port is available, the red dot changes to green and the Transmit Hex file icon  becomes visible.

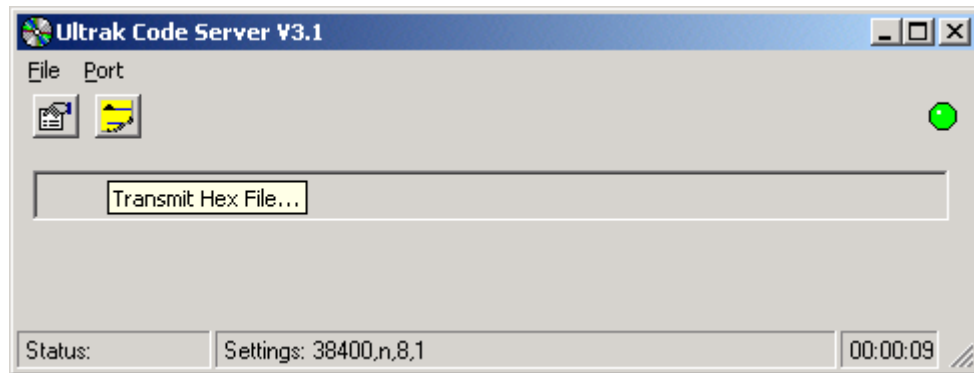

Figure 13. Transmit Hex File

7.2 DOWNLOADING NEW FIRMWARE TO THE HEGS5000, CONTINUED

10. Click on the Transmit Hex File Icon  to bring up the Send Hex File window.

Note: the hex file is located where you selected to save the Ultrak Code Server during the download process in Section 7.1.

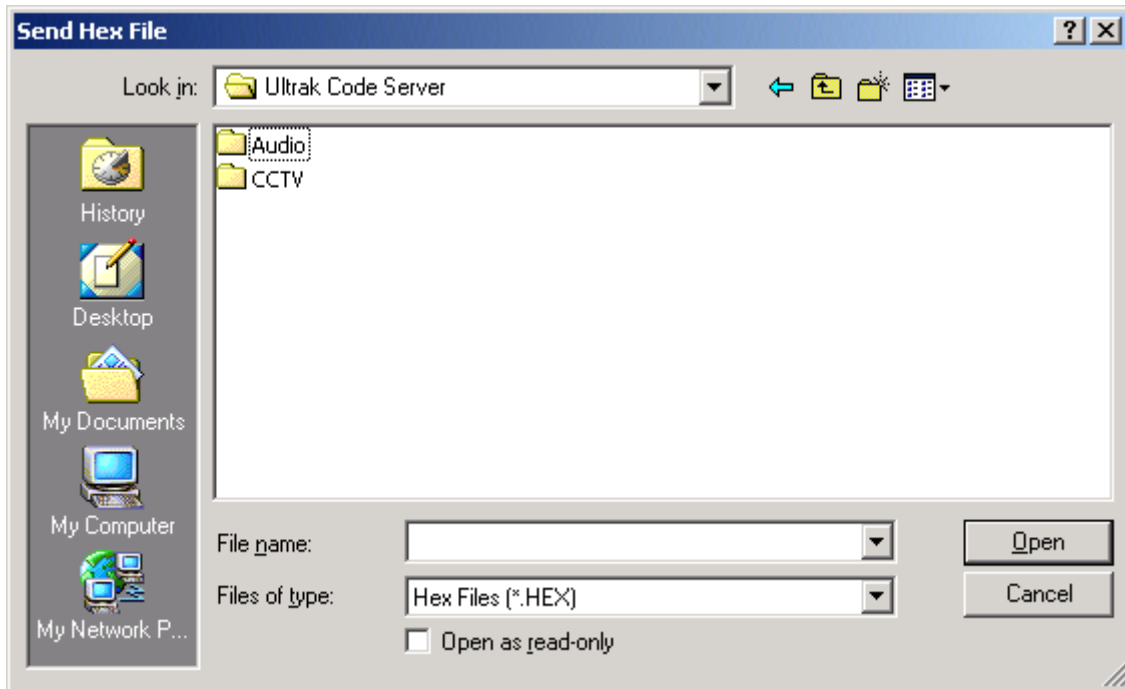

Figure 14: Send Hex File Window

11. Double click the CCTV folder and then double click on the HEGS5000_5001 folder.

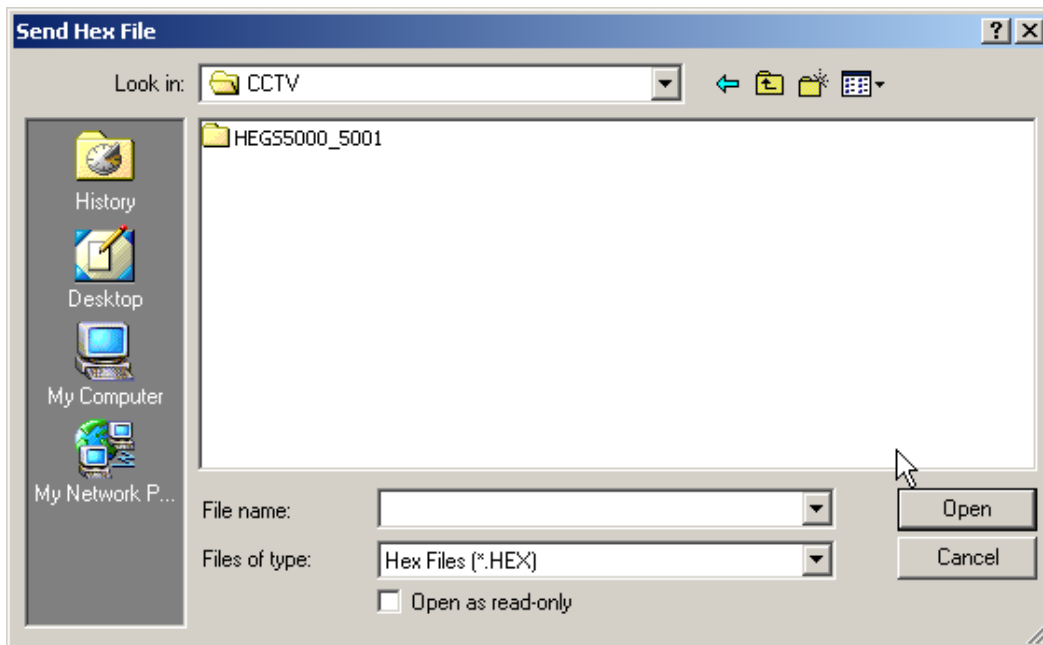

Figure 15: Selecting the Hex File to Send

7.2 DOWNLOADING NEW FIRMWARE TO THE HEGS5000, CONTINUED

12. Select the latest version of the firmware (e.g. 519686-1980_A_HEGS5000-5001.hex) and click OPEN. The Sending Hex File window displays, indicating the file being transmitted and the progress of the download. “**Download Busy**” appears on the HEGS5000 LCD.

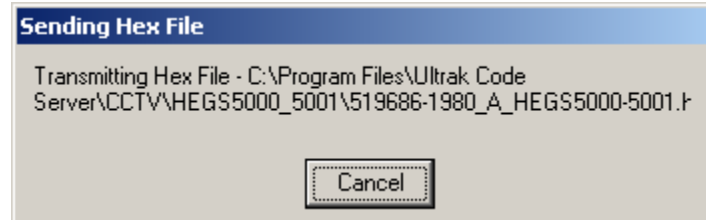

Figure 16: Sending Hex File Status Window

13. When the download is complete, a **Transfer Complete** window will display and the HEGS5000 will restart with the new version of the software.

Click OK to close the Ultrak Code Server.



Figure 17. Transfer Complete

Notes:

SECTION 8: TROUBLESHOOTING AND MAINTENANCE

8.1 TROUBLESHOOTING

If problems occur at the initial installation phase, verify the unit is installed correctly and the connectors are seated fully into the interconnecting equipment. Because this unit is just one part of an overall system, it may be necessary to verify that the other equipment types have been installed and are operating correctly before assuming the problem exists with the HEGS5000 controller.

8.2 DIAGNOSTICS

During the 5-second boot period after the controller is powered up, the operator can enter a code to test the joystick.

8.2.1 Joystick Test Modes

Press 2 during the 5-second boot period to enter the joystick mode. Move the joystick in all directions. The values are displayed on the LCD display.

X = Pan, Y = Tilt, Z = Zoom

When the joystick is in the center position at rest, all values should be 150 ± 10 .

Ranges:

X,Y = 110-190 +/- 10

Z = 100-200 +/- 10



To exit the joystick test mode, hold the VectorScan () key and the 1 key simultaneously for 5 seconds.

8.3 SERVICING THE CONTROLLER

If problems still exist after verifying correct installation and the problem has been isolated to the controller, then it must be removed for servicing. THERE ARE NO USER-SERVICEABLE PARTS. REFER SERVICING TO QUALIFIED PERSONNEL ONLY.

8.4 PREVENTIVE MAINTENANCE

Use of preventive maintenance allows detection and correction of minor faults before they become serious enough to cause equipment failure. As a result, major repairs can be avoided, and the equipment can be maintained in an operable condition with a minimum of maintenance.

Periodically perform the following:

1. Inspect all interface connecting cabling for deterioration or other damage.
2. Clean the front panel with a soft cloth using any mild commercial cleaner.

SECTION 9: SPECIFICATIONS

Input Voltage	9-12V dc
Power	6W
Controls	Push-button switches with backlit LCD display Rate-proportional 3-axis joystick
Pan/Tilt Functions	Pan left, pan right, tilt up, tilt down
Zoom Lens Functions	Zoom in, Zoom out, Focus near, Focus far, Iris open, Iris close
Control Ports	RJ-12 connector with 1xRS-485 and 1xRS-232 port
Communication speed	RS-232: 1200 baud RS-485: 9600 baud
Control Output Modes	RS-232 for Multiplexers and VCRs RS-485 for Domes and PTZs
Operating Distances	4000 feet (219m) with RS-485 and 32 devices 50 feet (12.7m) maximum with RS-232
Ambient Temperatures	32°F to 122°F (0°C to 50°C)
Ambient Humidity	0~95% (non-condensing)
Construction	Extruded aluminum
Finish	Light gray powder coating
Dimensions	13W x 3.75H x 6.875D inches (330W x 95H x 175D mm)
Weight	3 lbs (1.36 kg)

Honeywell Video Systems (Head Office)

2700 Blankenbaker Pkwy, Suite 150
Louisville, KY 40299
www.honeywellvideo.com
TEL +1-800-796-2288

Honeywell Security Australia Pty Ltd.

Unit 5, Riverside Centre, 24-28 River Road West
Parramatta, NSW 2150, Australia
www.ademco.com.au
TEL +61.2.8837.9300

Honeywell Security Asia Pacific

33/F Tower A, City Center, 100 Zun Yi Road
Shanghai 200051, China
www.security.honeywell.com/cn
TEL +86 21.2527.4568

Honeywell Security Asia

Flat A, 16/F, CDW Building, 388 Castle Peak Road
Tsuen Wan, N.T., Hong Kong
www.security.honeywell.com/hk
TEL +852.2405.2323

Honeywell Security France

Parc Gutenberg, 8, Voie La Cardon
91120, Palaiseau, France
www.honeywell-security.fr
TEL +33.01.64.53.80.40

Honeywell Security Italia SpA

Via Treviso 2 / 4
31020 San Vendemiano
Treviso, Italy
www.honeywell.com/security/it
TEL +39.04.38.36.51

Honeywell Security Espana

Mijancas 1.3a Planta
P.Ind. Las Mercedes
28022 Madrid, Spain
www.security.honeywell.com/es
TEL +34-902.667.800

Honeywell Video Systems Northern Europe

Network 121
1446 TR Purmerend, The Netherlands
www.SecurityHouse.nl
TEL +31.299.410.200

Honeywell Video Systems UK Ltd.

Aston Fields Road, Whitehouse Ind Est
Runcorn, Cheshire, WA7 3DL, UK
www.honeywellvideo.com
TEL +0844 8000 235

Honeywell Security South Africa

Unit 6 Galaxy Park, 17 Galaxy Avenue,
Linbro Park, P.O. Box 59904
2100 Kengray, Johannesburg, South Africa
www.honeywell.co.za
TEL +27.11.574.2500

Honeywell Security Deutschland

Johannes-Mauthe-Straße 14
D-72458 Albstadt, Germany
www.honeywell.com/security/de
TEL +49.74.31.8.01.0

Honeywell Security Poland

Chmielewskiego 22a, 70-028
Szczecin, Polska
www.ultrak.pl
TEL +48.91.485.40.60

Honeywell Security Czech Republic

Havránkova 33, Brno
Dolní Heršpice, 619 00, Czech Republic
www.olympo.cz
TEL +420.543.558.111

Honeywell Security Slovakia Republic

Vajnorskà 142, 83104 Bratislava
Slovakia
www.olympo.sk
TEL +421.2.444.54.660

Honeywell

Video Systems

www.honeywellvideo.com

1-800-796-CCTV (North America only)

HVSsupport@honeywell.com

Document 900.0800 06/06 Rev. 1.01

© 2006 Honeywell International Inc. All rights reserved. No part of this publication may be reproduced by any means without written permission from Honeywell Video Systems. The information in this publication is believed to be accurate in all respects. However, Honeywell Video Systems cannot assume responsibility for any consequences resulting from the use thereof. The information contained herein is subject to change without notice. Revisions or new editions to this publication may be issued to incorporate such changes.

Free Manuals Download Website

<http://myh66.com>

<http://usermanuals.us>

<http://www.somanuals.com>

<http://www.4manuals.cc>

<http://www.manual-lib.com>

<http://www.404manual.com>

<http://www.luxmanual.com>

<http://aubethermostatmanual.com>

Golf course search by state

<http://golfingnear.com>

Email search by domain

<http://emailbydomain.com>

Auto manuals search

<http://auto.somanuals.com>

TV manuals search

<http://tv.somanuals.com>