

USER GUIDE	MODEL NAME	PAGE
	<i>DDP-700</i>	i

TABLE OF CONTENTS

WHERE TO FIND IT

a glance guide to the buttons on your handset and base, and the messages on the handset display

The handset	1
The handset's display	2
The base	3

INSTALLATION DO's AND DONT's

how to install your DDP-700 and the things you will observed using your DDP-700-digital cordless telephone

Unpacking your DDP-700	4
Connection and condition for use	4
Choosing a site for the Base	4
Radio signal between handset and base	4
Electrical Safety	5
Emergency calls	5
Charging the batteries	5

GETTING STARTED

a first glance to know before you operate your DDP-700

Handset battery charge level	6
On / Off function	6
Out of range warning	6
Standby mode	6
The clock (time and date)	6

BASIC FUNCTIONS

Making a call

how to make and end a calls in different ways.

To make a call by Pre-dialing (external call)	8
To end a telephone call	8
To make a call from phonebook	8
To make a call from CID list (call back)	8
To make a call to another handset (internal call)	9
To make a call for Babysit	9
Last Number Redial	9
Outgoing Call Review / Redial	9

To answer a call

how to received calls in different ways.

Earphone mode	10
Speakerphone mode / handsfree	10

During a call

the things you can do during a call

Volume level	10
Microphone mute	10
Transferring an external call / External Call Hold	10
Conference call	11
Call Shuttle	11
Sending DTMF	11
Headset mode	11

USER GUIDE	MODEL NAME	PAGE
	<i>DDP-700</i>	ii

TABLE OF CONTENTS

Caller ID	how to use the caller ID features of your DDP-700	
	Call screening	12
	CID phonebook matching	12
	CID reserved and unavailable	12
	Auto talk	12
	Unanswered call review	13
	Delete CID	13
The phonebook	how to store, edit, and delete contact names and telephone numbers in your DDP-700 handset	
	To store name and number	14
	To edit entry	15
	To edit individual entry	15
	To delete all entry	16
PAGING THE HANDSET	to locate the handset or all handset registered tot the base, you can make it ring by pressing the page key	17
PERSONALIZED YOUR SETTING		
Ring Melody	how to select the ringing volume level, the ring melody for the internal and external call for base and handset.	
	Handset ring volume	18
	Handset ring melody for external call	18
	Handset ring melody for internal call	19
	Base ring volume	19
	Base ring melody	20
	Ring Priority	21
Warning tone	this will let you set your DDP-700 handset to emit beep when you press key, key confirmation, low battery and out of range.	
	Key Press	22
	Key Confirmation	22
	Low Battery	22
	Out of Range	23
The call timer	your DDP-700 handset will display the elapse time on the LCD.	23
The handset name	to personalized your individual handset name.	24
The keypad protect	to protect your DDP-700 handset from accidental dialing.	25
Choose your language	to choose the language Italiano and English.	25
Set the clock	ways to set, turn on/off your DDP-700 handset clock	26
Set alarm clock	to set your DDP-700 handset as alarm clock	27
Baby sitter	use your DDP-700handset for Babysit	28

USER GUIDE	MODEL NAME	PAGE
	<i>DDP-700</i>	iii

TABLE OF CONTENTS

EXPANDING YOUR DECT SYSTEM	how to register additional handset to your DDP-700 cordless DECT phone.	
Adding new handset	Another DDP-700 handset	29
	Another DECT GAP compliant handset	29
Pico Cellular system	how to configure your DDP-700 to cover larger area, register additional base to your DDP-700 cordless DECT phone.	30
	Register another DDP-700 base	31
	Another DECT GAP compliant base	31
	DDP-700 mobility	32
	choosing the base	32
ADVANCE FEATURES	how to configure your DDP-700 to cover larger area, register additional base to your DDP-700 cordless DECT phone.	
	Programming	33
	Change PIN Code	33
	Dialing mode	34
	PABX	35
	De-register handset	36
	Default setting	37
	LCR Feature - Italy	38
	Primary Code	38
	Desired Code	38
	Area code	38
	Access Code	38
	Special Code	40
	Routable Code	40
	Setting the Primary Code	41
	Setting the Others Code	42
	LCR On / OFF	44
	Factory Preset -Routable	45
	Factory Preset - Special Code	47
	Dialing LCR	48
	Call Barring	49
USE IN BUSINESS		
	Dialing Type	50
	Do you need a Pause	50
	PBX Access Code and Pause	50
	Do you need Recall (Flash)	50
	PABX storing number in the phonebook	50
TROUBLESHOOTING GUIDE	check the points here if you encounter problem with your DDP-700 or not working correctly,	51
PROGRAMMING QUICK REFERENCE GUIDE	easy reference for programming the DDP-700	53
TECHNICAL DETAILS	technical specifications of DDP-700	55

WHERE TO FIND IT

The Handset

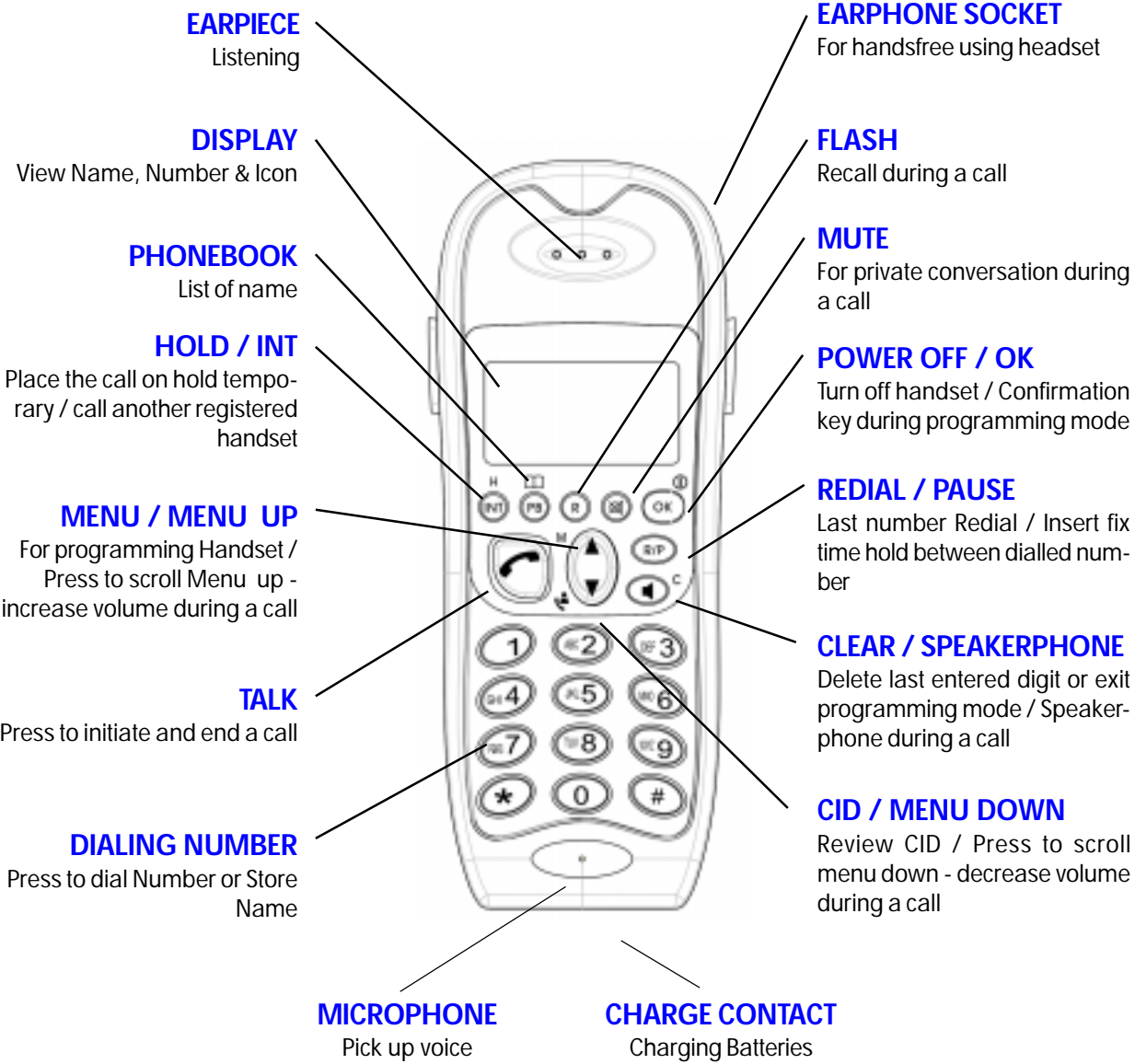

WHERE TO FIND IT

The Handset's display

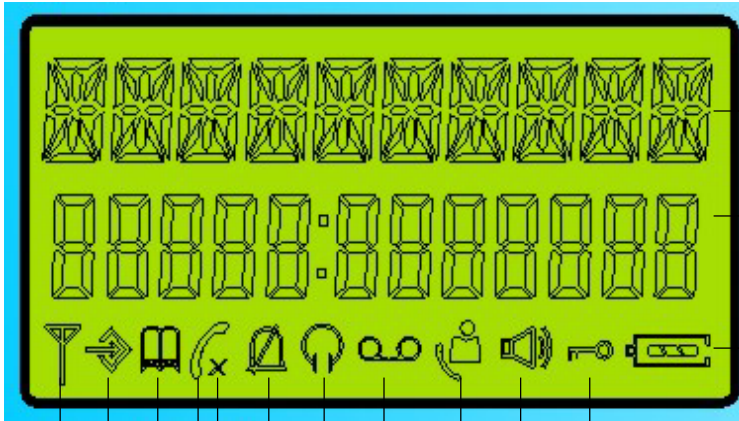

ALPHANUMERIC DISPLAY

Display Letters or Number

NUMERIC DISPLAY

Display Letters or Number

BATTERY

Battery Strength Level

KEY PAD LOCK

Keyboard is not Active

SPEAKERPHONE

Handsfree Operation

NEW CALL (CID)

New Call when flashing

ANSWERING MACHINE

Not Use

MONITOR

Baby Sitter or Room monitor

RING MUTE

Silent Ring for Handset

CONVERSATION MUTE

Microphone mute

CALL IN PROGRESS

Connected to the Telephone line or an Handset to Handset Call

PHONEBOOK

View names and numbers

PROGRAMMING

Programming Handset or Base

CONNECTION

Reception Status between handset and Base

WHERE TO FIND IT

The Base

CHARGE TERMINAL

It will contact with the handset terminal when place to cradle to charge the battery.

NEW CALL / IN USE INDICATOR

This indicator will flash if you have missed a call (new call)

During an external call, it will continuously light.

RING INDICATOR

When an incoming call, this indicator will light.

CHARGE INDICATOR

When you place the handset for charging, this indicator will light.

PAGE BUTTON

Press this key to find the handset/s. All registered handset will emit the page ring.

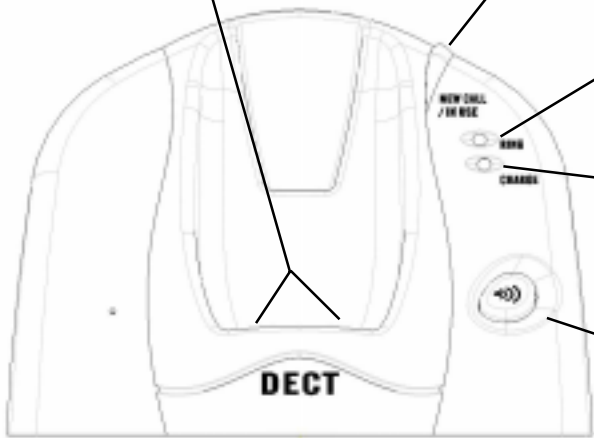

TEL. LINE / POWER LINE

Two separate Jack for the PSTN Telephone Line and AC mains power supply

USER GUIDE	MODEL NAME	PAGE
	<i>DDP-700</i>	4

INSTALLATION DO's AND DONT's

Unpacking your DDP-700

When you unpack your DDP-700, make sure you keep all packing materials in a safe place, in case you later need to transport it to return it for servicing. In the box, you will find :

- DDP-700 handset
- 2 pieces of battery
- a belt clip
- the DDP-700 base unit
- AC adaptor
- User Manual
- a telephone line cable

Connection and condition for use

The DDP-700 is connected to the public network using the standard telephone plug and socket systems.

You can connect your DDP-700 to :

- a line connected directly to a local exchange, with its own directory number
- an extension socket connected to a local exchange
- an extension on an approved PABX

Choosing a site for the Base

The DDP-700 base unit should be installed where :

- the mains adaptor plug will reach the 220V AC main power supply
- the telephone cable will reach your telephone line socket
- it is not close to another telephone
- it is not close to a sink, shower or anywhere else where it might get wet
- it is not close to other electrical equipment (washing machines, microwave oven, TV, fluorescent lights, etc.)

1. Choose a suitable site for the DDP-700 base
2. Plug-in the mains power lead and the telephone line cord on the DDP-700 base back side
3. Plug the mains AC adaptor into the AC mains socket
4. Insert the telephone line plug into the telephone socket.

Radio signal between handset and base

To use your DDP-700 cordless telephone, you must be able to establish a radio link. It is therefore noted that :

- placing the base unit as high as practical will give a better result.
- placing the base unit near any large metal object, like refrigerator or filling cabinet may block the transmission of radio signal
- other solid structures, like walls may reduce the radio signal strength

USER GUIDE	MODEL NAME	PAGE
	<i>DDP-700</i>	5

INSTALLATION DO's AND DONT's

Electrical Safety

1. **DO NOT** install the base unit near a sink, bath or shower or anywhere else where it could get wet. Electrical equipment can cause serious injury if used while you are wet or standing on water.
2. If the base unit ever falls into water, **DO NOT** retrieve it until you have unplugged the AC mains power adaptor and the telephone line plug from the telephone wall socket.
3. **DO NOT** allow the handset to come in contact with water
4. **DO NOT** open the handset or the base.
5. **DO NOT** allow the charging contacts or the battery to come in contact with electrical conductive materials such as metals, rings, paper clip, key, etc.
6. **MAKE SURE** you insert the batteries in correct polarity.
7. **NEVER USE** your DDP-700 in the open air during a thunderstorm - unplug the base unit from the telephone line and the AC mains socket where there are storms in your area. Damage caused by lighting may likely to happen.
8. If your DDP-700 is not to be used for long period of time, disconnect the main AC power adaptor from the AC power socket and the telephone line from the telephone wall socket

Emergency calls

Your DDP-700 need mains power. So you cannot use for placing a call during AC power failure.

Thus, a basic phone that does not need AC mains power is needed to place an emergency call during power failure.

Charging the batteries

Your DDP-700 handset need battery to operate. During the first use of your DDP-700, it is recommended that the handset is left over on charge overnight to ensure maximum in-use time.

1. Only use the rechargeable batteries supplied with your DDP-700
2. Install the rechargeable batteries into the rear of your handset. **MAKE SURE** you insert the batteries in correct polarity.
3. Position the battery cover over the rear of the handset and slide into place.
4. Place the handset on the base unit to charge.
5. The handset will beep and the red LED CHARGE light on the base unit.

NOTE : *If the charge do not light up, reposition the handset in the base unit ensuring the charging points contact.*

USER GUIDE	MODEL NAME	PAGE
	<i>DDP-700</i>	6

GETTING STARTED

Handset battery charge level

1. The Level of the battery power is indicated as a battery icon on the LCD display in the handset. If the battery icon shows empty, your DDP-700 need to be charge.
2. When in use and your DDP-700 emit battery low warning tone, your DDP-700 need to be charge
3. When fully charge your DDP-700 will operate for eight (8) hours talk time for earpiece, one hour for the speaker phone and 100 hours of standby time.

On / Off function

The button  when press and hold will switch on or off the power of your DDP-700 handset. When your DDP-700 is set to off, your DDP-700 will conserved the battery power, however placing and receiving a call cannot be made.

Out of range warning

If you are moving around during a call and you hear an out of range warning tone from your DDP-700 handset, thi means you are going out of your DDP-700 base coverage. Move a little closer until the tone stops. If you do not move, your call may be cut off. If your call will cut off, you will hear beep tone and your DDP-700 handset antenna icon will continuously flashing.

Press  , your DDP-700 handset will display BASE , flashing. You may need to go closer to the base to establish radio link between the handset and the base.







Standby mode

When the handset is not in use, the handset is in the **standby mode**. The LCD will display the handset name and number. The clock and date is also shown.

Note that, the clock and date should be set.





The clock (time and date)

Your DDP-700 handset can display the time and day. You should set it to the correct time and day at this time. For your first setting on your DDP-700 - digital cordless phone, follow the instruction below to set the time and day.

1. Press  up to select **HANDSET** menu.
2. Press .
3. Press  to select **CLOCK**.
4. Press .
5. Press  to select **SET CLOCK**.
6. Press  . The 2 digits hour number are blinking.
7. Press the hour on the numeric keypad, 05= 5 AM, 17=5 PM, 23=11 PM

USER GUIDE	MODEL NAME	PAGE
	<i>DDP-700</i>	7

GETTING STARTED

8. Press  down to go to the minutes setting. The 2 digits minutes are blinking.
9. Press the minutes directly on the numeric keypad, 01=for 1 minute, 25=25 minutes.
10. Press  down to go to the month setting. The 2 digits Month number are blinking.
11. Press the month directly on the numeric keypad, 01=January, 05=May, 11=November.
12. Press  down. The 2 digits Date are blinking.
13. Press the date directly on the numeric keypad (example : 01, 02, 10, 20, 31)
14. Press  . A confirmation tone is heard.
15. Press  three times to exit CLOCK setting or repeat 5 to 13 to set the clock once more.

CONGRATULATIONS!

You just made the first programming - setting the clock and date on your DDP-700- digital cordless phone.

Note : *When your DCT101 encountered AC power failure, or when you removed the AC adaptor, the clock will be inaccurate. Upon power up, it will be automatically set the time to **00:01** and the date to **1-01**. You need to set the correct time and date when your base is power on. See Set the clock -autocalibration on page 26, this will automatically set the date and time base on the FSK CID of the PSTN network. This will only work if your PSTN connection can provide FSK CID and have the date and time information.*

When your DDP-700 handset is out of battery power, just put the unit on the charge cradle on the base and the time and date will be restored. There is no need to set again the time and day.

If you register new DDP-700 handset, there is no need to set the clock on the new handset The Time and Date will synchronized to all handsets.

If you changed the Time and Date on one handset, the changes will take effect.

If you register another DECT GAP compatible to your DDP-700 base, the time and date may not be possible to display on the LCD of this new handset.



USER GUIDE	MODEL NAME	PAGE
	<i>DDP-700</i>	8

BASIC FUNCTIONS

Making a call

To make a call by Pre-dialing external call



Placing an external call is similar to dialing a Mobile Phone, dial the number then press the “send” key. This is the most convenient way for placing a call, since if you press a wrong number, you can delete it by pressing the clear key.

1. Dial the number you wish to call. If you made a mistake, press  to delete the number.
2. Press  to place the call. Your DDP-700 will seized the line and dial the number.



To end a telephone call

1. Press  at the end of your call.
2. Or, place your DDP-700 handset on the base unit cradle.

To make a call from phonebook

1. Press .
- Note :** If the LCD display *EMPTY*, store name and telephone number first, turn to page 14.
2. Press  to search the name you want to call.
 3. Press . The person’s telephone number will appear on the LCD. Your DDP-700 will seized the line and dial the telephone number.

To make a call from Caller ID list (call back)

1. Press  down. If it display *EMPTY*, you don’t have missed CID calls.
2. Press  to search the name or number you want to call.
3. Press . The telephone number will appear on the LCD. Your DDP-700 will seized the line and dial the telephone number.



USER GUIDE	MODEL NAME	PAGE
	DDP-700	9

BASIC FUNCTIONS

To make a call to another handset (internal call)

When you have more than one handset registered to your DDP-700 base, you can call this handset - this is internal call or handset to handset call as distinct to external call (outside telephone call).

You should know the number of the other handset register to your DDP-700 to make an internal call.



1. Press  followed by the handset number. Internal calling tone is heard.
2. The Intercom called user need to press  to received and end the Intercom call.

Note : *Your DDP-700 has a feature to distinct the ringing tone of an external call and internal call. Please see the detail on Handset ring melody for external call and internal call on page 18 and 19 respectively.*

To make a call for Baby Sitter (Monitor)



When you have more than one handset registered to your DDP-700 base, you can set the other handset to monitor a specified place, generally it is used for baby sitter. First, you should set the other handset to operate in Babysit mode, the Icon should be display on the handset LCD indicating the handset is in Babysit mode. Please see programming under Baby Sitter on page 28.

You should know the number of the other handset in Babysit mode. Place this handset in the desired place to monitor.



1. Press  followed by the handset number. You are calling the handset which set in Babysit Mode.
2. The other handset will take the call automatically. You can hear the surrounding sounds from your DDP-700 on the earpiece, earphone or speakerphone mode.
3. Press  on your DDP-700 to end.

Last Number Redial

When LCR function is active (See page 38 and 44), use Outgoing Call Review / Redial to dial Last Number.

1. Press  followed by  .
2. Your DDP-700 will dial the last number you used in making a call.

Outgoing Call Review / Redial

1. Press  . Press  to review up to 10 numbers or names. If you dialed out from Phonebook, the name will appear instead of the number.
2. Press  if you wish to dial the number.



USER GUIDE	MODEL NAME	PAGE
	<i>DDP-700</i>	10

BASIC FUNCTIONS

To answer a call

Unless priority has been setup, your DDP-700 base and handset will ring at the same time, please see Personalized Your Setting under Ring Priority on page 21. See Page 12 if CID service is available in your telephone line.

Earpiece mode

- When your DDP-700 ring, press  if it is off the base charging. If it is on the charging cradle, picking up your DDP-700 will go to TALK mode without pressing the . See page 12 for Autotalk with CID.

Speakerphone mode / handsfree

- When your DDP-700 ring, press . You may place your DDP-700 handset on a table and speak and listen freely within 1 meter away.



During a call

Volume level

- Press  up to increase the volume or  down to decrease the volume while in the earphone mode or speakerphone mode.





Microphone mute

If you want to speak secrecy with any person in your side without sending it to the person on the phone.

- Press . You can now speak freely, the other person on the telephone line will not hear you.
- Press  again to un-mute your DDP-700. Conversation is again possible.

Transferring an external call / External Call Hold

If you have more than one handset registered to your DDP-700 base, you can transfer the external call to this handset. You should know the number of the other handset register to your DDP-700 to transfer the call.

- When you are engaged in external call, press  followed by the handset number where you wish to transfer the call. While calling the other handset, the external call is on HOLD. The called handset need to press  to answer the internal call.
- Once the other handset has been connected, press  on your handset to transfer the external call.
- If the other handset is no answer or do not want to take the external call, press  to return to the external call.







Note : *The transferred call can be transfer back to the first handset who take the call, or to another handset (if there are more handsets) registered to your DDP-700.*

USER GUIDE	MODEL NAME	PAGE
	<i>DDP-700</i>	11

BASIC FUNCTIONS

Conference call

If you have more than one handset, you can have a three (3) conference call with another handset and an external call. You should know the number of the other handset register to your DDP-700.

1. When you are engaged in external call, press  followed by the handset number where you wish to have a conference call. Internal calling tone is heard, the external call is on HOLD.
2. The Intercom called user need to press  to answer the other handset call.
3. Once the other handset has been connected, press   on your handset to active conference call. *(The called handset by Intercom cannot initiated the conference call, only the handset who called internal call can initiate the conference call).*
4. If the called handset don't want to have conference or no answer, the calling handset need to press  to return back to the external call.
5. If one of the DDP-700 user wish to leave the conference call, press , the other user can continue the call. If during the 3 conference call, the external call leave, the internal handset to handset connection retain and communication is still possible, however, the busy tone is heard. To end the handset internal call, press  on each handset.

Call Shuttle

If you have more than two handsets registered to your DDP-700 base, one handset can have an external call, the two other handset can have internal call. You can also transfer the EXTERNAL call to other handset, then transfer the call again to another handset, shuttle backward and forward the EXTERNAL call.

Sending DTMF

You can use the keypad (0 to 9, * and #) to send tones during a call. For example, to operate an answering machine, or to key in option for an automated answering services or for home banking.

Headset mode

Your DDP-700 handset has a headset jack so that earphone can be used. Earphone is convenient to use in handsfree operation (if don't want to use speakerphone) while working or doing something where in you cannot accommodate to handle the handset.

1. Plug the 2.5mm male mobile phone headset jack located on the right top corner of your DDP-700
2. Wear the headset. Arranged the microphone so that it closely to your mouth. Placing and receiving a call is now possible using your headset.

USER GUIDE	MODEL NAME	PAGE
	<i>DDP-700</i>	12



BASIC FUNCTIONS

Caller ID

Caller Identity Delivery (CID) is a feature of Telephone system and DDP-700 that will let you see who is calling on the line. DDP-700 CID feature will also let you know who calls you in your absence.

Call Screening

With CID service implemented on your telephone line, when your DDP-700 rings, the caller's number will display on your DDP-700 handset. (If your telephone system service can provide the caller name, your DDP-700 will display the caller's name instead of the number). You have the option to received the call or not. If you don't received the call, your DDP-700 will saved the caller's number or name. Your handset CID icon and Base In-use/New Call LED will flash indicating a missed call.

1. When your DDP-700 ring, calling number will appear in your handset display if CID service is available.
Press  to take the call.
2. Press  again to end the call or you may simply put your handset on the base charge cradle.

CID Phonebook Matching

With CID service implemented in your telephone, if the caller's number will match the telephone number you stored in your phonebook, it will display the name same as the name in the phonebook rather than the CID number or name. If this is a missed call, when you review the caller list, it will display the name same as in the phonebook and not the number or name.

CID Reserved and Unavailable

If CID service is available in your telephone network and your DDP-700 will display UNAVAIL or RESERVED when an external call comes in, this means that the caller information is not available (UNAVAIL) or withheld (RESERVED).

Autotalk

When CID service is implemented in your telephone line, your DDP-700 will bypass autotalk feature.

When your DDP-700 handset is on the base charging cradle and an external call comes in with CID information, your DDP-700 handset will not auto talk if you pick up the handset from the base cradle. Your DDP-700 will let you see who is calling (CID information : name or number) and let you decide if you wish to answer the call or not.

Press  to answer the call. If you do not answer, it will register as New Call /Missed call and your DDP-700 base New call indicator and handset icon are flashing.





If your telephone line is not provided with CID service, when you pick up your DDP-700 from the base charging cradle, your DDP-700 will undergo autotalk, thus, there is no need to press the  key.

USER GUIDE	MODEL NAME	PAGE
	<i>DDP-700</i>	13







BASIC FUNCTIONS

Unanswered call review

During your absence or not able to attend to a call, your DDP-700 will remember the caller's number and time of call. Your DDP-700 base NEW CALL indicator and your handset CID icon will flashing indicating a missed calls. Your DDP-700 can saved 25 missed calls. If calls is more than 25, the old callers will be deleted to give space for new callers. To review caller's during your absence,

1. Press  down. (If there is no CID, the LCD will display **EMPTY**).
2. If your telephone service provides the name and number of the caller, the name will be display first.
Press  The telephone number will display.
3. Press  the time of call will display.
example. 14h50 08-01 - means 2 PM, 50 minutes January 08
4. Press  to exit Caller ID review or press  to review.

Delete CID







1. Press  down and select the name or number you want to delete.
(If there is no CID, the LCD will display **EMPTY**).
2. Press .
3. If the caller name is appear instead of the number, press  three times. If the caller's number will display , press  two times.
4. Your DDP-700 will ask you if you really want to delete it by asking CONFIRM? Pres  to confirm deletion. A confirmation tone is heard. If you don't want to delete it, press  and your DDP-700 will bypass deletion.

BASIC FUNCTIONS

The Phonebook

Your DDP-700 can store 40 names and numbers. For each entry, you can program a name of 8 characters, number up to 18 digits. You can store new number, edit existing number or delete.

To store name and number













1. Press  up to select **PHONEBOOK** menu.
2. Press  to select **NEW**.
3. Press  . LCD will display **NAME?**
4. Key in the name (maximum 8 characters). Please see table of alphanumeric table below
5. Press  . A confirmation tone and LCD will display **NUMBER?**
6. Key in the telephone number (maximum 18 digits)
7. Press  . A confirmation tone is heard.
8. Press  to exit Phonebook entries or repeat step 3 to 7 to add more entries
9. Press  again to exit phonebook programming mode and return to standby mode.

Digit	Pressing of Digits			
	1x	2x	3x	4x
1	space			
2	A	B	C	
3	D	E	F	
4	G	H	I	
5	J	K	L	
6	M	N	O	
7	P	Q	R	S
8	T	U	V	
9	W	X	Y	Z
0				











USER GUIDE	MODEL NAME	PAGE
	<i>DDP-700</i>	15

BASIC FUNCTIONS

To edit entry

1. Press  up to select **PHONEBOOK** menu.
2. Press .
3. Press  to select **EDIT**.
4. Press .
5. Search the name to be edit using  . Press .
6. Press  to delete a character to the left side of the cursor or add character by pressing the correct letter.
7. Press  . A confirmation tone and the LCD will display the number.
8. Press  to delete a number to the left side of the cursor or add number by pressing the correct number.
9. Press  . A confirmation tone is heard.
10. Press  to exit EDIT or repeat step 2 to 9 to edit more entries
11. Press  two times to exit phonebook programming mode and return to standby mode.







To delete individual entry

1. Press  to select **PHONEBOOK** menu.
2. Press .
3. Press  to select **DELETE**.
4. Press .
5. Search the name to be edit using  . Press .
6. DDP-700 will display the number. Press .
7. DDP-700 will prompted CONFIRM?. Press  to Delete . A confirmation tone will hear.
8. Press  to exit DELETE or repeat step 3 to 7 to delete more entries.
9. Press  again to exit phonebook programming mode and return to standby mode.

USER GUIDE	MODEL NAME	PAGE
	<i>DDP-700</i>	16

BASIC FUNCTIONS

To delete all entry

1. Press  to select **PHONEBOOK** menu.
2. Press .
3. Press  to select **DEL ALL**.
4. Press .
5. Your handset will prompted CONFIRM?. (**WARNING : Press  . This will delete all entries**)
6. Press  to delete all Names and Number. A confirmation is hear.
7. Press  two times to exit DELETE ALL programming mode and return to standby mode.

USER GUIDE	MODEL NAME	PAGE
	<i>DDP-700</i>	17

BASIC FUNCTIONS

Paging the handset

This feature is very useful if you can't remember where you put your handset - you can make it ring by pressing the PAGE button on your DDP-700 base.

All registered handsets will ring. You can stop each handset by pressing any key on the handset keypad.







USER GUIDE	MODEL NAME	PAGE
	<i>DDP-700</i>	18

PERSONALIZED YOUR SETTING

Ring and Melody









Handset ring volume

This will set Incoming call (call from PSTN) and internal call (call from other registered handset) ring volume.

1. Press  up to select **HANDSET** menu.
2. Press  **VOLUME** menu will appear.
3. Press  . The handset will ring the current volume setting. Default is VOLUME 5.
4. Press  to select Volume off (VOL OFF), 1,2,3,4 and 5 levels. Level 5 is the maximum.
5. Press  . A confirmation tone is heard.
6. Press  to exit RING VOLUME or repeat step 2 to 5 to change handset ring volume again.
7. Press and hold  to exit handset programming mode and return to standby mode.

Handset ring melody for external call









This will set Incoming call (call from PSTN) ring melody

1. Press  up to select **HANDSET** menu.
2. Press  .
3. Press  to select **EXT RING**.
4. Press  The handset will ring the current EXT melody setting. The default is Melody 1.
5. Press  to select 1,2,3,4 and 5 different melody tones.
6. Press  . A confirmation tone is heard.
7. Press  to exit EXT MELODY or repeat step 2 to 6 to change the EXT melody again.
8. Press and hold  to exit handset programming and return to standby mode.

PERSONALIZED YOUR SETTING











Handset ring melody for internal call

This will set Internal call (call from other registered handset) ring melody.

1. Press  up to select **HANDSET** menu.
2. Press .
3. Press  to select **INT RING**.
4. Press . The handset will ring the current INT melody setting. The default is melody 5.
5. Press  to select 1,2,3,4 and 5 different melody tones.
6. Press . A confirmation tone is heard.
7. Press  to exit INT MELODY or repeat step 2 to 5 to change INT melody again.
8. Press and hold  to exit handset programming mode and return to standby mode.

Base ring volume

This will set Incoming call (call from PSTN) ring volume.











1. Press  up to select **BASE** menu.
2. Press .
3. Press  to select **RINGER**
4. Press .
5. Press  to select **VOLUME**.
6. Press  The Base will ring the current ring volume setting. The default is VOLUME 5.
7. Press  to select Volume off (VOL OFF), 1,2,3,4 and 5 level. Level 5 is the maximum.
8. Press . A confirmation tone is heard.
9. Press  to exit RING VOLUME or repeat step 4 to 8 to change base ring volume again.
10. Press and hold  exit base ring programming and return to standby mode.

USER GUIDE	MODEL NAME	PAGE
	<i>DDP-700</i>	20

PERSONALIZED YOUR SETTING

Base ring melody

This will set Incoming call (call from PSTN) ring melody.



















1. Press  up to select **BASE** menu.
2. Press  .
3. Press  to select **RINGER**.
4. Press  .
5. Press  to select **MELODIES**.
6. Press  The Base will ring the current ring melody setting. The default is melody 1.
7. Press  to select 1,2,3,4 and 5 different melody tone.
8. Press  . A confirmation tone is heard.
9. Press  to exit MELODIES or repeat step 4 to 8 to set base ring melody again.
10. Press and hold  to exit base ring melody programming and return to standby mode.

USER GUIDE	MODEL NAME	PAGE
	<i>DDP-700</i>	21

PERSONALIZED YOUR SETTING

Ring Priority





This function will set the handset or base to ring first when an external incoming call takes place. You can set the number of rings takes place on the device prioritized before other will ring. When base is the priority to ring first, CID information will only appear on the LCD when handset start to ring. While the base is ringing, press the talk key on handset will not seized the line. Wait till the handset will ring and then press talk key.

1. Press  up to select **BASE** menu.
2. Press  .
3. Press  to select **RINGER**
4. Press  .
5. Press  to select **PRIORITY**.
6. Press  .
 - 6.1 Press  to select **NO**
 - 6.1.1. Press  , ring priority is off.
 - 6.2 Press  to select **YES**
 - 6.2.1. Press  ring priority is active and effect your setting.
 - 6.3 Press  to select **SETUP**
 - 6.3.1 Press  .
 - 6.3.2 Press  to select Base, Handset1, Handset2, Handset3, Handset4 and Handset5
 - 6.3.3 Press  .
 - 6.3.4 Press  to select rings : 1,2,3,4,5,6,7,8 and 9
 - 6.3.5 Press  You must set your DDP-700 to YES to take effect ring priority settings.
7. Press  to exit RING PRIORITY or repeat step 6.
8. Press and hold  to exit ring priority and return to standby mode.



PERSONALIZED YOUR SETTING

Warning Tones





This will set tones on or off.

0. Press  to select **HANDSET** menu.
1. Press .
2. Press  to select **TONES**.
3. Press .





4.1 KEY (when you press the keypad tone will emit if set to ON)

- 4.1.1 Press .
- 4.1.2 Press  to select **YES** or **NO**.
- 4.1.3 Press . A confirmation tone is heard.

4.2 CONFIRM (in programming, it will emit a tone for “confirmation” if set to ON)

- 4.2.1 Press  to select **CONFIRM**.
- 4.2.2 Press .
- 4.2.3 Press  to select **YES** or **NO**.
- 4.2.4 Press . A confirmation tone is heard.

4.3 LOW BATT (your DDP-700 will emit a tone when battery is low, if set to ON)

- 4.3.1 Press  to select **LOW BATT**.
- 4.3.2 Press .
- 4.3.3 Press  to select **YES** or **NO**.
- 4.3.4 Press . A confirmation tone is heard.

USER GUIDE	MODEL NAME	PAGE
	<i>DDP-700</i>	23

PERSONALIZED YOUR SETTING

4.4 Range (if your DDP-700 is out of coverage, it will emit a tone, if set to ON)



4.4.1 Press  to select **RANGE** menu.

4.4.2 Press .

4.4.3 Press  to select **YES** or **NO**.

4.4.4 Press . A confirmation tone is heard.

Note :

In any case, Press  to exit, press  2 times to exit Warning Tone Programming and go to standby mode.

The call timer

Your DDP-700 will display the time you take in using the handset during conversation. This feature can be turned on and off.

1. Press  to select **HANDSET** menu.

2. Press .

3. Press  to select **TIMER**.

4. Press .

5. Press  to select **YES** or **NO**.

6. Press . A confirmation tone is heard.

7. Press  to exit CALL TIMER or repeat step 3 to 6 to set call timer again.









8. Press and hold  to exit handset programming mode and return to standby mode.

USER GUIDE	MODEL NAME	PAGE
	<i>DDP-700</i>	24

PERSONALIZED YOUR SETTING

The handset name

You can change the name of your DDP-700 handset. The default name is **HANDSET**.

1. Press  to select **HANDSET** menu.
2. Press .
3. Press  to select **HS NAME**.
4. Press .
5. Key in the name (maximum 8 characters). Please see table of Alphanumeric Keypad on page 14.
Press  to delete a character to the left side of the cursor or add character by pressing the correct letter.
6. Press . A confirmation tone is heard.
7. Press  to exit HS NAME or repeat step 3 to 6.
8. Press and hold  to exit handset programming mode and return to standby mode.





USER GUIDE	MODEL NAME	PAGE
	<i>DDP-700</i>	25

PERSONALIZED YOUR SETTING





The keypad protect

To prevent accidental dialing, use the KEYPAD LOCK Mode. Your DDP-700 will not respond to any key except MENU Key ( up)

Set keypad to lock





1. Press  up to select **KEY LOCK** menu.
2. Press  .
3. Press  to select **YES**
4. Press  . Your DDP-700 will now go to standby-Keylock mode. The Key Icon will display on the LCD.

Set keypad to active

1. Press  up to select **KEY LOCK** menu.
2. Press  .
3. Press  to select **NO**.
4. Press  Your DDP-700 will now go to standby mode. The Key Icon will disappear on the LCD and keypad dialing is now possible..

Choose your language





You can change the Language displayed on your DDP-700. The options are English and Italian.

1. Press  up to select **LANGUAGE** menu.
2. Press  .
3. Press  to select **ENGLISH** or **ITALIANO**.
4. Press  . Your DDP-700 will now go to standby mode.

USER GUIDE	MODEL NAME	PAGE
	<i>DDP-700</i>	26

PERSONALIZED YOUR SETTING

Set the clock

0. Press  to select **HANDSET** menu.
1. Press 
2. Press  to select **CLOCK**.
3. Press 
4. Press  to select **AUTOMATIC**, **SET CLOCK**, **OFF** or **ON**.

4.1 Auto calibration

- 4.1.1 Press 
- 4.1.2 Press  to select **YES** or **NO**.

Note : *When you select to "YES", the time will be base on the TIME of the Telephone Network. The time setting by your will be obtain from the time of Caller ID. This is best if you don't want to set the time and just relay on the telephone network time. If set to YES, make it sure that CID is available in your telephone service. (Note : CID FSK with date and time only).*

- 4.1.3 Press 



4.2 Set Clock (Please refer to page 6- the clock)

4.3 ON - Set TIME and DATE display on your handset

- 4.3.1 Press  This will display the time and date in your DDP-700 handset

4.4 OFF - Turn off the TIME and DATE display on your handset

- 4.3.1 Press  This will not display the time and date in your DDP-700 handset













5. Press  to exit **CLOCK** or repeat step 4 to 5.
6. Press and hold  to exit handset programming mode and return to standby mode.

USER GUIDE	MODEL NAME	PAGE
	<i>DDP-700</i>	<i>27</i>

PERSONALIZED YOUR SETTING

Set alarm clock

Your DDP-700 alarm function is set on daily basis. After alarm, the function will set to alarm off. You need to set again to "on". Alarm duration is 30 seconds. Press any key on your DDP-700 to stop the alarm.

0. Press  to select **HANDSET** menu.
1. Press 
2. Press  to select **ALARM**.
3. Press 
4. Press  to select **ALARM TIME** or **SET ALARM**.
 - 4.1 **Alarm time**
 - 4.1.1 Press  The hour setting is blinking.
 - 4.1.2 Press the time on the keypad. (00 to 23). ex. 2 PM= 14, 5 AM=05
 - 4.1.3 Press  down. The minute setting is blinking.
 - 4.1.4 Press the minute. (00 to 59)
 - 4.1.5 Press  A confirmation tone is heard. You must set your DDP-700 to ALARM ON to take effect your setting.
 - 4.2 **Set Alarm**
 - 4.2.1 Press  to select **YES** or **NO**.
 - 4.2.2 Press  A confirmation tone is heard.
5. Press  to exit ALARM or repeat step 2 to 4.
6. Press and hold  to exit handset programming mode and return to standby mode.

USER GUIDE	MODEL NAME	PAGE
	<i>DDP-700</i>	28





PERSONALIZED YOUR SETTING

Baby sitter





Monitor Mode is used for Baby sitter or for Room Monitoring (the handset is put in child's bedroom and monitor the room for crying, noise, etc).

When you have one handset registered to your DDP-700 base, the other handset can be set to BABYSIT MODE.

Set to "ON"

1. Press  up to select **BABYSIT** menu.
2. Press  .
3. Press  to select **YES**.
4. Press  . A confirmation tone is heard. Your DDP-700 will go to BABSIT MODE. The LCD will show the Icon.

Set to "OFF"

1. Press  up to **BABYSIT**.
2. Press  .
3. Press  to select **NO**.
4. Press  . A confirmation tone is heard. Your DDP-700 will now go to standby mode.

Use Handset in Babysit Mode

Call the other handset on BABYSIT mode, by pressing  followed by the handset number. The called handset will automatically take the call and the caller will hear the condition of the room.

The caller press  to stop the room monitoring. The other handset in BABYSIT MODE will automatically go to the standby mode.

The caller can repeat the room monitoring function as many times as desired.

During an incoming external call, the handset will not ring if it is in BABYSIT MODE.

USER GUIDE	MODEL NAME	PAGE
	<i>DDP-700</i>	29

EXPANDING YOUR DECT SYSTEM

Adding new handset



Another DDP-700 handset

Your DDP-700 Mini DECT cordless phone is a GAP compliant (Generic Access Profile) which can access and interwork with other GAP DECT. You can register up to five GAP DECT handsets to your DDP-700 base.

The handset number is displayed at the right side upper corner of the LCD of your handset. It is label as 1 to 5. Your original handset is the first to be registered to your base, so, it is labeled as HANDSET 1.

To register another DDP-700 handset to your base; you should know your DDP-700 system PIN code. This is a numerical digit code (maximum of 8 digits). It was preset to 0000. You can changed this PIN code if you like that your DDP-700 cordless phone system will not access by other person.

You cannot register another handset to your DDP-700 if you don not know the PIN code.

1. Press  up to select **REGISTER** menu of the new handset to be register to your Ddp-700 base.
2. Press  Your DDP-700 LCD will display BS 1 2 3 4. One (1) is flashing indicate that this handset has been register to base 1.
3. Press 2, to select that this handset will be register to another base #2 (other than the original base).
4. Enter the present PIN code of your DDP-700 system. (default code is 0000). Press  .
Your handset is now looking for Base # 2.
5. Press and Hold the Page key on Base # 2 where you intend to register this handset until it will emit 2 beeps. Release the page button. Your base is now in subscription mode.
6. The handset will subscribed to the base shortly, if not, put the handset closer to the base. After registration, your handset number will be HANDSET 2.

Another DECT GAP compliant handset

For registration of another DECT GAP compliant handset to your DDP-700 base, you should know the procedure for registration of this handset and the PIN code of your DP-700 base. Refer to the user manual.

For setting your DDP-700 base to subscription mode, press and hold your base page key until two beep emit and then release. Your base is now in subscription mode.

Note :

Due to DDDP-700 have clock features (time and date stamp on the LCD), some GAP DECT Phone can work well with DDP-700 base, however, if this Handset don't have clock and date stamp on the LCD, it may result to auto-paging this handset.

EXPANDING YOUR DECT SYSTEM

Pico cellular system

Your DDP-700 MINI DECT cordless phone can be configured as a pico-cellular system by adding more base placed in different locations. This will extend your handset mobility. This application can be implemented in the office or factory. If you configure your DECT system to operate in pico-cellular, you should see to it that the placement of base unit will be optimized to cover the entire location where you intend to use your DDP-700 handset.

The following should be observed :

1. Register another base/s (another DDP-700 base or another DECT GAP compatible) to your DDP-700 handset.
2. Place these base in the location where you intend to operate your handset, place them to cover all area without dead spot, this means that each base station is within the range of each other base. Please see figure below :

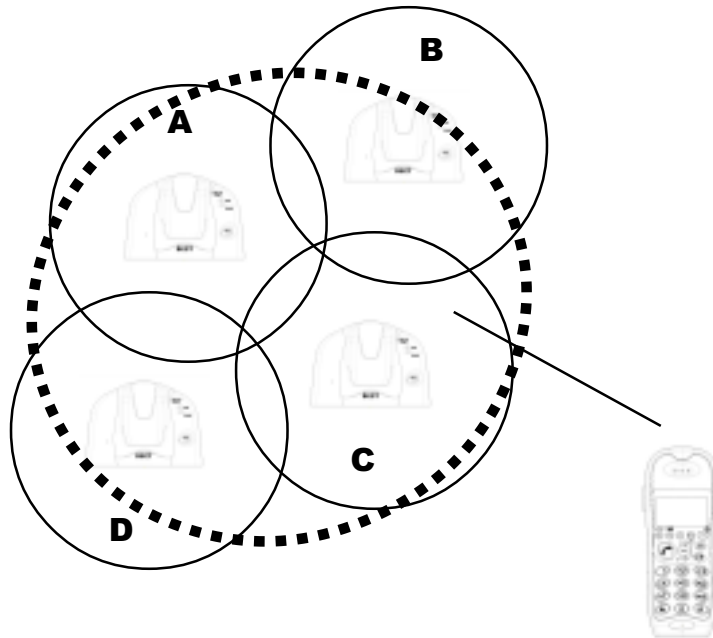



3. Your DDP-700 however cannot establish a seamless handover (handover means the transfer of call-connection from the range of location A to location B, please see figure above). The handover from location A to B takes about 2 seconds or more. Thus, when you are on call progress on location D and moving to location C, your DDP-700 will warn you (if *out of range warning* is set to on-see warning tone) of out of range from location D. If you move closer to location C, your DDP-700 handset will lose connection and call will be cut off. If you move further to location C, your DDP-700 handset will be connected to the base located at C.

USER GUIDE	MODEL NAME	PAGE
	DDP-700	31

EXPANDING YOUR DECT SYSTEM

Register another DDP-700 base

1. Press  up to select **REGISTER** menu.
2. Press  Your DDP-700 LCD will display BS 1 2 3 4. One (1) is flashing indicate that this handset has been register to base 1.
3. Press 2, to select that this handset will be register to another base #2 (other than the original base).
4. Enter the current PIN code of your DDP-700 system. Pres  .
Your handset is now looking for Base # 2; **SEARCH 2** will display on your DDP-700 handset.
5. Press and Hold the Page key on Base # 2 where you intend to register this handset until it will emit 2 beeps. Your base is now in subscription mode.
6. The handset will subscribed to the base shortly, if not, put the handset closer to the base. Your DDP-700 base will automatically assigned your handset number based on the free handset registration. If you handset become HANDSET 3 after registration, this means that this base has already register 2 handsets, and your handset is the third to registered.

Another DECT GAP compliant base

For registration of another DECT GAP compliant base to your DDP-700 handset, you should know the procedure for registration of this base and the PIN code. Please refer the User guide (User manual).

USER GUIDE	MODEL NAME	PAGE
	<i>DDP-700</i>	32

EXPANDING YOUR DECT SYSTEM

DDP-700 mobility

Your handset can be used in two locations. You can use your DDP-700 handset at home with your base station and you can bring your DDP-700 handset to your office, thus you are using a single handset for home and office. Your DDP-700 handset must be register to your base station at office.

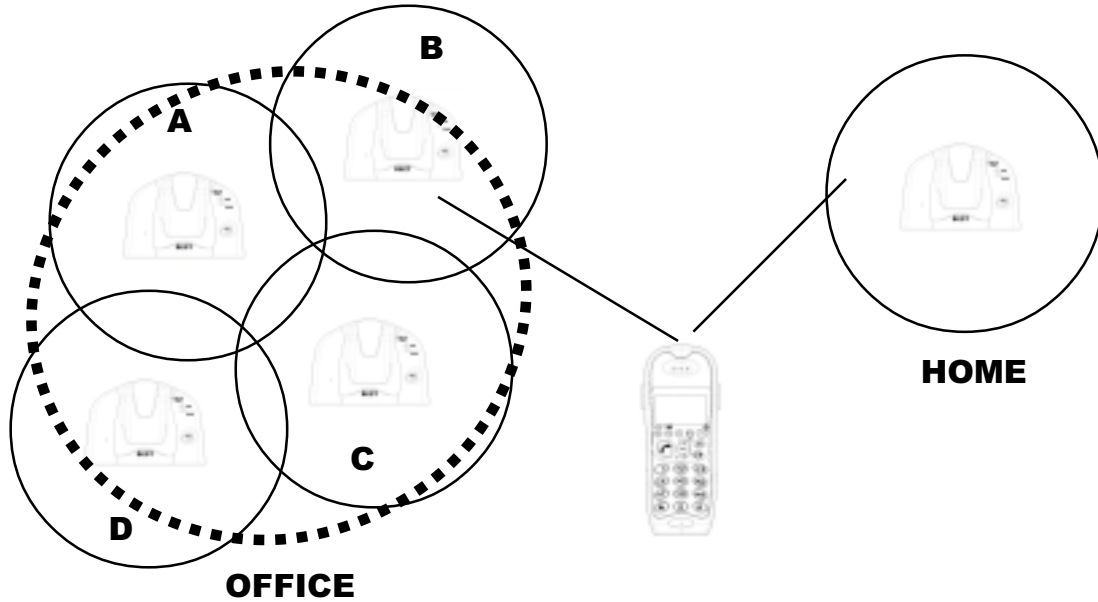

Choosing the Base

In multi base application- pico cellular systems, your DDP-700 handset will automatically search for the base in that particular area. If more than one base is available, your DDP-700 handset will use the base with the strongest signal.

USER GUIDE	MODEL NAME	PAGE
	<i>DDP-700</i>	33

ADVANCE FEATURES











Programming

The following will describe some features of your DDP-700 cordless phone for users who want to do more than simply make and answer calls.

If you have only one handset and base unit, and if you do not need to prevent unauthorized use of your DDP-700 DECT phone, you probably won't need the Advanced Features.

Changed PIN Code

Due to the restriction for programming, your DDP-700 must be protected with user PIN. The default PIN is 0000. You can changed this PIN code, however, you must choose a PIN number which is easy to remember by you or write the PIN code secretly. The maximum digit for PIN is 8 digits (example 35575431).

1. Press  up to select **BASE** menu.
2. Press .
3. Press  . To select **ADVANCED..**
4. Press  The LCD will display PIN. Enter the current PIN Code.
5. Press  _CD will display CALL BAR if you entered the correct PIN otherwise display ADVANCED and beep a long tone. This means your PIN is wrong.
6. Press  to select PIN CODE.
7. Press  Your DDP-700 will ask you for the NEW PIN code.
8. Enter the "new" pin code, maximum 8 digits combination of 0-9. Press .
9. Your DDP-700 will ask you to repeat entering the "new" PIN Code.
10. Press  A confirmation tone is heard.
11. Press and hold  to exit Advance programming.

IMPORTANT!!!

- do not forget your PIN Code -

make sure, the new PIN CODE is a number you'll be able to remember and make a note of it.











Please note your new PIN here!

USER GUIDE	MODEL NAME	PAGE
	<i>DDP-700</i>	34

ADVANCE FEATURES

Dialing Mode















Choose this features to changed the dialing mode of your DDP-700. Before you do so, please consult your tele- phone company. It is better not to changed this, since your DDP-700 was preset to DTMF mode wherein most telephone network can accept.

1. Press  up to select **BASE** menu.
2. Press  .
3. Press  . To select **ADVANCED**.
4. Press  The LCD will display PIN. Enter the current PIN Code.
5. Press  . LCD will display CALL BAR if correct PIN entered else display ADVANCED.
6. Press  to select **DIAL MODE**.
7. Press  .
8. Press  to select **TONE** or **PULSE**
9. Press  .
10. Press and hold  to exit Advance programming.

ADVANCE FEATURES

PABX

Choose this features if your DDP-700 is to be used with PABX. Refer to page 50 : Business application of DDP-700











1. Press  up to select **BASE** menu.
2. Press  .
3. Press  . To select **ADVANCED**.
4. Press  The LCD will display PIN. Enter the current PIN Code.
5. Press  . LCD will display CALL BAR if correct PIN entered otherwise it display ADVANCED.
6. Press  to select **PABX PAUSE**.
7. Press  .
8. Press  to select **PBX CODE** or **PAUSE**
 - 8.1 **PAUSE**
 - 8.1.1 Press  .
 - 8.1.2 Press  to select **3 SECONDS** or **5 SECONDS**
 - 8.1.3 Press  . A confirmation tone is heard.
 - 8.2 **PBX CODE**
 - 8.2.1 Press  .
 - 8.2.2 Press the PBX code, usually digit 9. (Press  to delete PBX code)
 - 8.2.3 Press  . A confirmation tone is heard.
9. Press and hold  to exit PBX set up and return to standby mode.

USER GUIDE	MODEL NAME	PAGE
	<i>DDP-700</i>	36

ADVANCE FEATURES

De-register a handset

If you have more than one handset register to you base, you can de-register (remove subscription from your DDP-700 base) the other handset. If you have only one handset, you cannot de-register your own DDP-700 handset to its base.









1. Press  up to select **BASE** menu.
2. Press  .
3. Press  . To select **ADVANCED**.
4. Press  The LCD will display PIN. Enter the current PIN Code.
5. Press  . LCD will display CALL BAR if correct PIN entered otherwise it display ADVANCED.
6. Press  to select **DEL HS**.
7. Press  .
8. Press  to select **HANDSET 1,2,3,4, and 5**.
9. Press  Your DDP-700 will ask you to CONFIRM?
10. Press  to delete the handset you selected, otherwise press and hold  to exit DE-REGIS
TER handset and return to standby mode.

USER GUIDE	MODEL NAME	PAGE
	<i>DDP-700</i>	37

ADVANCE FEATURES

Default setting

This feature will restore the default setting of your DDP-700 cordless phone. All programming earlier done like setting the ringing volume, ringing melody, PIN, external call melody, etc. will be defaulted.

1. Press  up to **BASE** menu.
2. Press  .
3. Press  . To select **ADVANCED**.
4. Press  The LCD will display PIN. Enter the current PIN Code.
5. Press  . LCD will display CALL BAR if correct PIN entered otherwise it display ADVANCED.
6. Press  to select **DEFAULT**.
7. Press  . Your handset will ask you to CONFIRM?
8. Press  A confirmation tone will be heard. Your handset (or all handset register to the base) will temporarily lost subscription link to the base, after few seconds, the handset will acquire again the link to the base. The time display on the LCD would take around 60 second to display.
9. Press and hold  to exit DEFAULT SETTING and return to standby mode.

Note :

When performing the default <reset>

- The phonebook memory will not erase entries
- LCR Codes and programming entries will retain
- Handset Name will not change

USER GUIDE	MODEL NAME	PAGE
	<i>DDP-700</i>	38

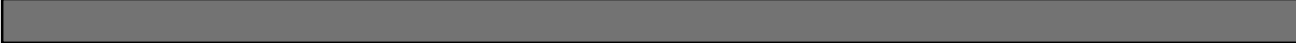

USER GUIDE	MODEL NAME	PAGE
	<i>DDP-700</i>	39



USER GUIDE	MODEL NAME	PAGE
	<i>DDP-700</i>	40

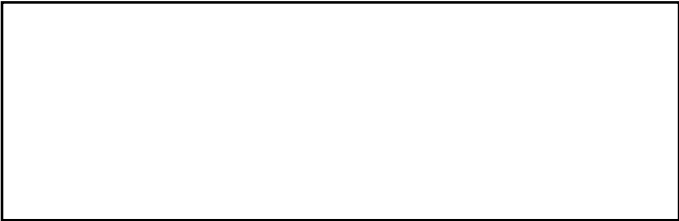







USER GUIDE	MODEL NAME	PAGE
	<i>DP-700</i>	41

ADVANCE FEATURES

Primary code

This is gateway number for the LCR Network who provide the service of routing the call. In one location, it is possible that there are more than one LCR network provider.

















1. Press  up to select **LCR** menu.
2. Press  Your DDP-700 will ask you to enter the PIN Code. (See PIN CODE Setting)
3. Enter the PIN Code. Press .
4. Press  to select **PRIMARY**.
 - 4.1 **Set PRIMARY Code**
 - 4.1.1 Press  Enter the "LCR access code" number. You can enter up to 6 digits number 0~9. You can only enter one LCR network provider access code. In case, there are more than one LCR network provider in your place, choose the most common use LCR access code.
 - 4.2 **Edit PRIMARY Code**
 - 4.2.1 Press  once to remove one digit to the left of the cursor or press the correct digit.
5. Press and hold  to exit LCR programming and go to standby mode

USER GUIDE	MODEL NAME	PAGE
	<i>DDP-700</i>	42

ADVANCE FEATURES











Others Code

This feature of your DDP-700 will allow you to specify your preferred LCR access code and preferred area code. If you dial the area code that match one of the area code in the Others code table, it will route your call using your preferred access code.

1. Press  up to select **LCR** menu.
2. Press  Your DDP-700 will ask you to enter the PIN Code. (See PIN CODE Setting)
3. Enter the PIN Code. Press .
4. Press  to select **OTHERS**. Press .
 - 4.1 Press  to select **NEW**
 - 4.1.1 Press .
 - 4.1.2 Enter desired AREA NO, maximum 6 digits.
 - 4.1.3 Press .
 - 4.1.4 Enter the desired ACCESS NO, maximum 6 digits.
 - 4.1.5 Press . A confirmation tone is heard.
 - 4.1.6 Press and Hold  to exit LCR programming and return to standby mode, press once to exit store OTHERS code or repeat 4.1 to store another area and access code. The maximum area and access codes you can enter is 10.
 - 4.2 Press  to select **EDIT**
 - 4.2.1 Press .
 - 4.2.2 Search the area code or access code to be edit using . Press .
 - 4.2.3 Press  to delete one character to the left side of the cursor or add character by pressing the correct number.
 - 4.2.4 Press . A confirmation tone is heard.
 - 4.2.5 Press and Hold  to exit LCR programming and return to standby mode, press once to exit edit OTHERS code or repeat 4.2.

USER GUIDE	MODEL NAME	PAGE
	<i>DDP-700</i>	43

ADVANCE FEATURES







- 4.3 Press  to select **DELETE**
- 4.3.1 Press  .
- 4.3.2 Search the code to be delete using  .
- 4.3.3 Press  . The LCD will ask you to CONFIRM.
- 4.3.4 Press  to confirm delete.
- 4.3.5 Press and Hold  to exit LCR programming and return to standby mode, press once to exit delete individual access and area code or repeat 4.3 to delete another codes.
-
- 4.4 Press  to select **DELETE ALL**
- 4.4.1 Press  .
- 4.4.2 Your DDP-700 will prompt to you, CONFIRM?
- 4.4.3 Press  . A confirmation tone is heard.
- 4.4.4 Press and Hold  to exit LCR programming and return to standby mode, press once to exit delete all desired access and area code or repeat 4.4.

USER GUIDE	MODEL NAME	PAGE
	<i>DDP-700</i>	44

ADVANCE FEATURES

LCR On / Off

The LCR feature of your DDP-700 can be turn it ON or OFF. You must turn to ON if you use LCR feature.

1. Press  up to select **LCR** menu.
2. Press  Your DDP-700 will ask you to enter the PIN Code. (See PIN CODE Setting)
3. Enter the PIN Code. Press .
4. Press  to select **NO** or **YES**.
5. Press . A confirmation tone is heard.
6. Press and Hold  to exit LCR programming and return to standby mode.

USER GUIDE	MODEL NAME	PAGE
	<i>DDP-700</i>	45















ADVANCE FEATURES

FACTORY PRESET -Routable Code:

It is highly recommended that you just leave this codes untouched. However, if you add routable codes you can program them. Factory preset area codes are : 0, 00, 3 and 4.













Routable Code

This is the routable code number and is preset in the factory. When LCR is "on", your DDP-700 will compare the dialed number to the routable code table, if it match, it will route the call.

1. Press  up to select **LCR** menu.
2. Press  Your DDP-700 will ask you to enter the PIN Code. (See PIN CODE Setting)
3. Enter the PIN Code. Press .
4. Press  to select **ROUTABLE**.
 - 4.1 Press  to select **NEW**
 - 4.1.1 Press .
 - 4.1.2 Enter area code, maximum 5 different area codes each maximum of 6 digits.
 - 4.1.3 Press .
 - 4.1.4 Press and Hold  to exit LCR programming and return to standby mode, press once to exit routable code setting or repeat 4.1 to store another code.
 - 4.2 Press  to select **EDIT**
 - 4.2.1 Press .
 - 4.2.2 Search the routable code to be edit using . Press .
 - 4.2.3 Press  to delete one character to the left side of the cursor or add character by pressing the correct number.
 - 4.2.4 Press . A confirmation tone is heard.
 - 4.2.5 Press and Hold  to exit LCR programming and return to standby mode, press once to exit edit routable code or repeat 4.2.

USER GUIDE	MODEL NAME	PAGE
	<i>DDP-700</i>	46

ADVANCE FEATURES

- 4.3 Press  to select **DELETE**
- 4.3.1 Press  .
- 4.3.2 Search the code to be delete using  .
- 4.3.3 Press  Your DDP-700 will prompt to you, CONFIRM?
- 4.3.4 Press  to confirmed delete or press  to cancel delete.
- 4.3.5 A confirmation tone is heard if you press  .
- 4.3.6 Press and Hold  to exit LCR programming and return to standby mode, press once to exit delete individual routable code or repeat 4.3 to delete another code.
-
- 4.4 Press  to select **DEL ALL**
- 4.4.1 Press  .
- 4.4.2 Your DDP-700 will prompt to you, CONFIRM?
- 4.4.3 Press  . A confirmation tone is heard.
- 4.4.4 Press and Hold  to exit LCR programming and return to standby mode, press once to exit delete all routable code or repeat 4.4.

USER GUIDE	MODEL NAME	PAGE
	<i>DDP-700</i>	47















ADVANCE FEATURES

FACTORY PRESET - Special Code

It is highly recommended that you just leave this codes untouched. However, if you add non-routing special codes, you can program them. Factory preset special codes are : 0366, 0369, 0563, 0769, 0878, 0989.













Special Code

This is the non-routing codes which bypass the LCR function even the first or first two digits fall under routable area codes. You can enter up to 10 special codes, each up to 6 digits. There are already 6 factory preset.

1. Press  up to **LCR** menu.
2. Press  Your DDP-700 will ask you to enter the PIN Code. (See PIN CODE Setting)
3. Enter the PIN Code. Press .
4. Press  to select **SPECIAL**.
 - 4.1 Press  to select **NEW**
 - 4.1.1 Press .
 - 4.1.2 Enter special code, maximum 10 different special codes each maximum of 6 digits.
 - 4.1.3 Press .
 - 4.1.4 Press and Hold  to exit LCR programming and return to standby mode, press once to exit special code or repeat 4.1 to store another special code.
 - 4.2 Press  to select **EDIT**
 - 4.2.1 Press .
 - 4.2.2 Search the special code to be edit using . Press .
 - 4.2.3 Press  to delete one character to the left side of the cursor or add character by pressing the correct number.
 - 4.2.4 Press . A confirmation tone is heard.
 - 4.2.5 Press and Hold  to exit LCR programming and return to standby mode, press once to exit edit special code or repeat 4.2.

USER GUIDE	MODEL NAME	PAGE
	<i>DDP-700</i>	48

ADVANCE FEATURES

- 4.3 Press  to select **DELETE**
- 4.3.1 Press  .
- 4.3.2 Search the code to be delete using  .
- 4.3.3 Press  Your DDP-700 will prompt to you, CONFIRM?
- 4.3.4 Press  to confirmed delete or press  to cancel delete.
- 4.3.5 A confirmation tone is heard if you press  .
- 4.3.6 Press and Hold  to exit LCR programming and return to standby mode, press once to exit delete individual special code or repeat 4.3 to delete another code.
-
- 4.4 Press  to select **DEL ALL**
- 4.4.1 Press  .
- 4.4.2 Your DDP-700 will prompt to you, CONFIRM?
- 4.4.3 Press  . A confirmation tone is heard.
- 4.4.4 Press and Hold  to exit LCR programming and return to standby mode, press once to exit delete all special code or repeat 4.4.

Dialing LCR

There is no difference in dialing a normal telephone number and routing telephone number. LCR routing number can be directly dialed using the key pad (pre-dialing), Phonebook or CID or redial. Please refer to page 8 and of this User Guide for the different ways of dialing a number.

It is recommended when using LCR function to use Pre-dialing as described on Page 8- To make a call by Pre-dialing external call. When re-dialing is required, it is recommended to use Outgoing Call review / Redial as stated on page 9.

USER GUIDE	MODEL NAME	PAGE
	<i>DDP-700</i>	49

ADVANCE FEATURES

Call Barring

Choose this features if you would like to restrict your DDP-700 to use for calling.











There are three ways you can restrict your DDP-700 for calling numbers:

- a) Local
- b) National
- c) International

When you restrict your DDP-700 for local call, any number you dial will be barred. If you restrict your DDP-700 to National, any telephone number starting with "0" and or "00", your DDP-700 will not dial. If you restrict your DDP-700 to INTERNATIONAL, any telephone number starting with "00", your DDP-700 will not dial.

If you have more than one handset (multiple handset use), you can select to restrict each handsets.

When your DDP-700 is connected to PABX, If Call Barring is active, it will barred only telephone number after the PABX code. Internal PABX call is not affected.

1. Press  up to select **BASE** menu.
2. Press  .
3. Press  . To select **ADVANCED**.
4. Press  The LCD will display PIN. Enter the current PIN Code.
5. Press  . LCD will display **CALL BAR** if correct PIN entered otherwise it display **ADVANCED**.
6. Press  .
7. Press  to select **Handset1, Handset2, Handset,3, Handset4 or Handset5**
8. Press  (if you have selected which handset you want to CALL Barred.
 - 8.1 Press  to select **NO BARRING, LOCAL, NATIONAL or INTERNATIO**.
 - 8.1 Press  .
9. Press and Hold  to exit Call Barring programming and return to standby mode.

Use Call Barring Feature :

When Call Barring is active, if you dial a telephone number that is barred, the Base will turn off and will not dial the number. Your DDP-700 handset will emit a tone, indicating unsuccessful dial.

Press  or put back your DDP-700 to base to return to standby mode.

When you turn off the Call Barring function, all 3 levels of barring will be turn off. You need to set each level of call barring again.

USER GUIDE	MODEL NAME	PAGE
	<i>DDP-700</i>	50

USE IN BUSINESS

USE IN BUSINESS?

Your DDP-700 can be plugged into an extension socket on most PABX. It cannot, however, be guaranteed that it will work satisfactory with all type of PABXs, if you have problems, please consult the authorized maintainer of your PABX. Before attempting to use your DDP-700 in your PABX, please refer to the features described in your PABX User Manual.

Dialing type

Your DDP-700 is set to tone dialing. These settings are correct for nearly all PBXs. However, if you find that you cannot make calls or use PABX features with your DDP-700, the setting may need to be changed. Consult the documents supplied with your PABX.

Do you need a PAUSE ?

Your PABX Manual may tell you that, after dialing the outside PABX access code (usually 9), you should wait for another second Dial Tone before dialing the external call- telephone number. Some PABX do not require you to wait. If you do NOT need to wait for dial tone, you will not need press the PAUSE button **R/P** to insert Pause during dialing or when storing number in memory. If you need to wait for the second dial tone, you can use the **R/P** where indicated.

There are two ways you can set the pause if your PABX require it.

1. Using the **R/P** key to insert in dialing number.
ex. Dialing 008522678 in your PABX with an access code of 9 would be : 9 **R/P** 008522678.
Your DDP-700 will insert a 3 sec pause after the PABX access code "9" then dial the outside number.
2. You can use of DDP-700 full feature PABX Pause and PBX access code. Please refer to page 35. It is better to makes use of the DDP-700 PABX feature. In this way, you can makes use of the Outgoing Call Redial function. Dialing an external call would be much easier. If you dial the same number as above example, you simply dial 9008522678 and your DDP-700 will automatically insert the Pause after the PABX access code.

PABX Access Code and PAUSE ?

Your DDP-700 has programmable PAUSE. You can set the PAUSE duration in PABX Menu on page 35, under Base, PABX-Pause. Please Refer to your PABX User Manual.

Your DDP-700 has programmable PABX Access Code (usually 9). You must programmed the PABX access code in your DDP-700 to makes use of its full PABX feature. Please refer on page 35.

Do you need Recall (Flash)?

Your DDP-700 Recall time is 100msec. Consult your PABX user manual if you can use it. Predial function (page 8) , Redial (page 9) and full PABX feature (page 36) of your DDP-700 will make easier to use DDP-700 when connected to PABX. At standby mode, dial the telephone number, you should place your PABX access code (usually 9). If you make a mistake you can edit easily. If the line is busy, turn off your phone and call again after some minute, and make use the redial function to dial the same number.

PABX Storing number in the Phonebook

For external call, always put the PABX access code before the telephone number, follow the procedure on page 14. For PABX internal call, there is no need to put the PABX access code.

USER GUIDE	MODEL NAME	PAGE
	<i>DDP-700</i>	51

TROUBLESHOOTING GUIDE

TROUBLESHOOTING GUIDE

Problem	Possible Cause	Action Taken
Programming Display NOT AVAIL	RF Interference occur during programming.	Retry the programming, if possible move closer near the DDP-700 base station
Interference during communications	Out of range or close to other electrical appliances	Check the handset is not emitting the out of range warning tone. If close to other electrical device move away. You may need to reconsider the location of your DDP-700 if this problem persist.
Entries will not be accepted in the PHONEBOOK.	Phonebook is full	Up to 40 names and numbers can be stored in the DDP-700 phonebook. Delete some of the older entries to make more space for new one.
Time reset to 00:01 1:01	The base power was remove or base was reset.	The base if power was interrupted, the time will also reset. Please set the time again.
DDP-700 is in strange mode	Multiple selection from the Menu Structure.	Reset all the user-set features to the factory default under Base Menu.
DDP-700 cannot make call	The base unit may not be correctly connected.	Ensure the base unit is correctly installed and connected. Make sure that the power is On.
	Other handset are already in communications (in multi handset user)	Make sure that, only one internal and external call can be made at the same time. Ensure that other handsets are not already in communication prior to use.
	Call Barring feature has been set up	Make sure that the Call Barring feature is not enable.
	LCR feature has been set up	If you are using LCR, make sure you are using the correct access codes.
	Network Failure	Try making a call from another telephone. If unsuccessful, contact your network supplier.
	If connected to PABX	Make sure you have entered the correct PABX code in PBX feature of DDP-700.

USER GUIDE	MODEL NAME	PAGE
	<i>DDP-700</i>	52

TROUBLESHOOTING GUIDE

Problem	Possible Cause	Action Taken
Base Station does not function	Error in connection or lack of power supply.	Ensure that the Adaptor power supply has been connected to the DDP-700 and the adaptor is properly plug in to the AC power plug. Ensure that the AC power should match the Adaptor AC voltage.
Handset does not function	Battery pack may not be installed correctly.	Ensure that the battery pack has been correctly installed. Follow the polarity marking of the battery and the drawing on DDP-700 handset battery compartment.
	Battery may need further charging	If DDP-700 does not work when first connected, charge the handset for the recommended charging period.
Registration fail	Wrong registration procedure	<p>Make sure that you know your DDP-700 PIN code. If you are registering new handset to you DDP-700 base, make sure you follow the procedure for registering of this another DECT handset.</p> <p>Try again if possible.</p>

PROGRAMMING QUICK REFERENCE GUIDE

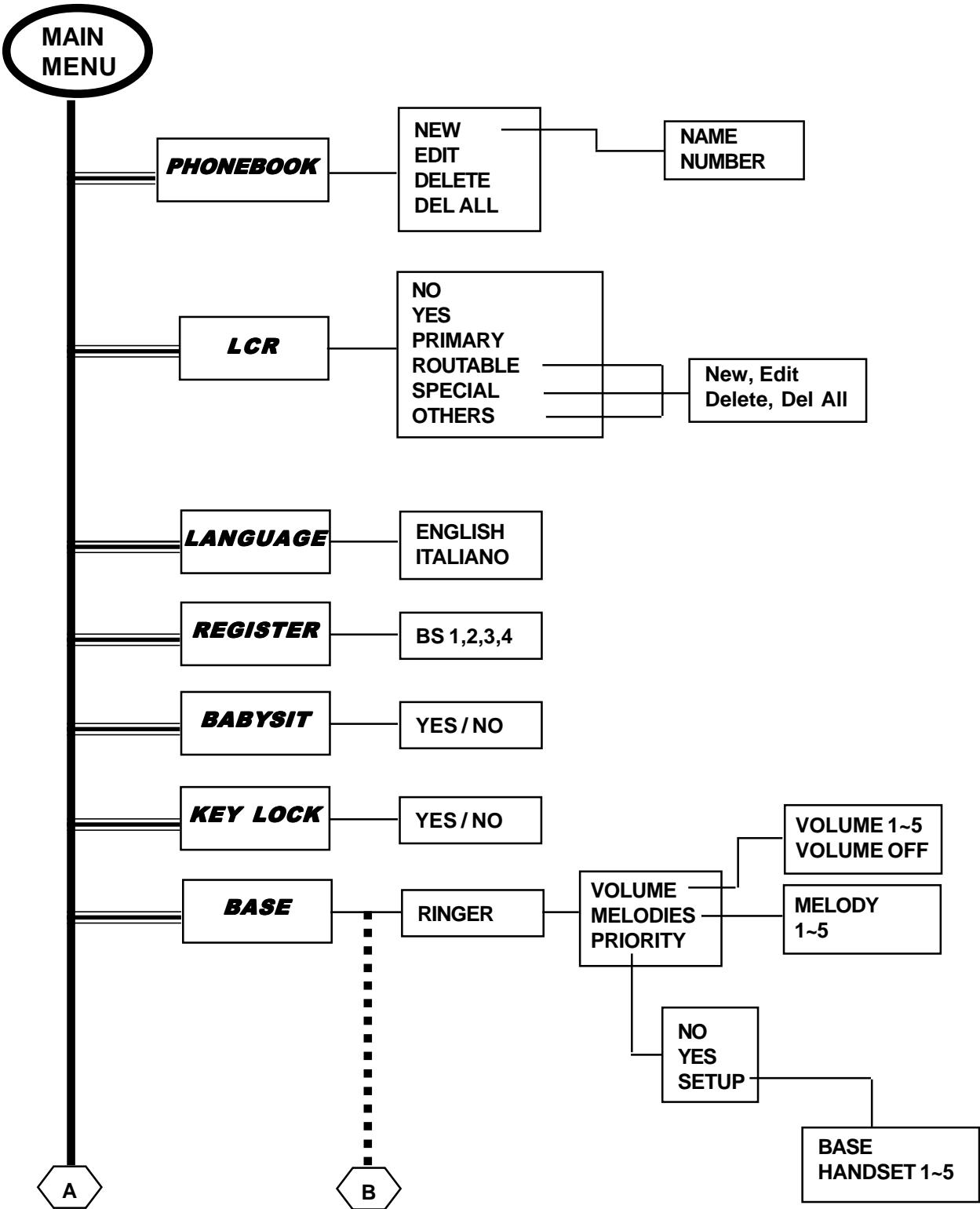

PROGRAMMING QUICK REFERENCE GUIDE

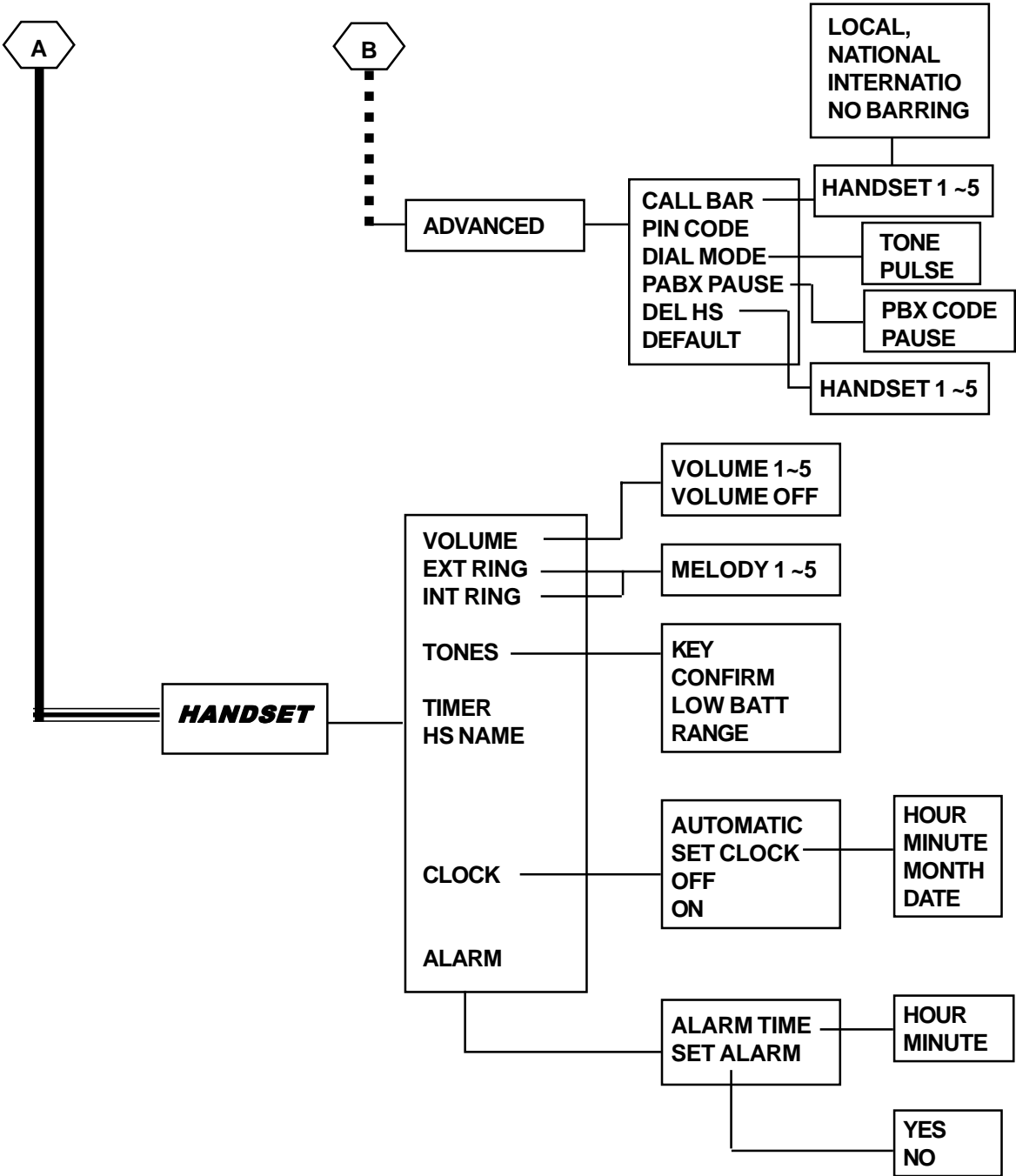

TECHNICAL DETAILS

Standard	Digital Enhanced Cordless Telecommunications (DECT)
Frequency	1.88 to 1.9 GHz
Channel Bandwidth	1.728 MHz
Modulation	GFSK
Data Rate	1.152 Mbps (Baud rate)
Duplexing	Time Division Duplex (TDD)
RF Accessing	Time Division Multiple Access (TDMA)
Channel	120 TDMA channel
Speech Encoding	Adaptive Differential Pulse Code Modulation (ADPCM) at 32 Kbps
Speech Security	Digital Security
Communications Range	about 300 meters in open space (no block) about 50 meters in building
Power Supply	
Handset	Ni-Mh battery : 2.4 Vdc, 550mAm (2 x 1.2 AAA)
Base	Input : 230 Vac / 50Hz Output : 9.0 Vac / 200mA 6.5 Vdc / 300mA
Operating Time	
Standby	100 hours
Talking Time	8 hours (headset / earphone mode) 1 hour (speakerphone mode)
Operating Temperature	0 °C to 40 °C
Storage Temperature	-20 °C to 60 °C

Free Manuals Download Website

<http://myh66.com>

<http://usermanuals.us>

<http://www.somanuals.com>

<http://www.4manuals.cc>

<http://www.manual-lib.com>

<http://www.404manual.com>

<http://www.luxmanual.com>

<http://aubethermostatmanual.com>

Golf course search by state

<http://golfingnear.com>

Email search by domain

<http://emailbydomain.com>

Auto manuals search

<http://auto.somanuals.com>

TV manuals search

<http://tv.somanuals.com>