

How to get the best from **Your Dishwasher**

Contents

Air Gap	18	Problem Solver	15-17
Appliance Registration	2	Rinse Agent	10
Care and Cleaning	18	Safety Instructions	3
China, Crystal, Sterling	4, 14	User Maintenance Instructions	18
Consumer Services	23	Warranty	Back Cover
Convenience Features	2	Water Temperature	10
Cycle Features	6	Winter Storage	18
Detergent, Detergent Guide	10, 11		
Dispenser Cups	11		
Display Panel	7-9		
Econo-120 System	10		
Energy Saver	5		
Energy-Saving Tips	2		
Front Panel Color Change	19		
Loading	12, 13		
Model and Serial Numbers	2		
Operating Instructions	4,5		
Cycle Selection	4		
Dishwashing Shortcut	6	GE Answer Center®	
Drying Options	5,6	800.626.2000	

Use and Care 01
built-in model
HDA2000M

HOTPOINT

Help us help you...

Before using your dishwasher, read this book carefully.

It is intended to help you operate and maintain your new dishwasher properly.

Keep it handy for answers to your questions.

If you don't understand something or need more help, write (include your phone number):

Consumer Affairs
Hotpoint
Appliance Park
Louisville, KY 40225

Write down the model and serial numbers.

You'll find them on a label fastened to the tub wall just inside the dishwasher door.

These numbers are also on the Consumer Product Ownership Registration Card that came with your dishwasher. Before sending in this card, please write these numbers here:

Model Number

Serial Number

Use these numbers in any correspondence or service calls concerning your dishwasher.

Convenience features

This dishwasher has many convenient features. Among them are:

- Controls are arranged left to right as you use them.
- Automatic "beep" responses to instructions and a lighted display let you know the desired function has been selected.

If you received a damaged dishwasher...

Immediately contact the dealer (or builder) that sold you the dishwasher.

Save time and money. Before you request service . . .

Check the Problem Solver (pages 15 through 17). It lists causes of minor operating problems that you can correct yourself.

Energy-saving tips

- Operate dishwasher only when it's full. Let the dishes accumulate in dishwasher. When you put in only a partial load, use the RINSE& HOLD cycle to rinse off heavy soils. Be sure to latch the door when waiting for a full load. This helps keep soils moist, easier to remove.
- Always select the cycle that uses least amount of water that will remove the soil from the load. See page 6.
- If you don't need your dishes right away, use your ENERGY SAVER drying feature that turns the drying heater off automatically. Dishes dry naturally over a longer period such as overnight.

If you need service

To obtain service, see the Consumer Services page in the back of this book.

We're proud of our service and want you to be pleased. If for some reason you are not happy with the service you receive, here are three steps to follow for further help.

FIRST, contact the people who serviced your appliance. Explain why you are not pleased. In most cases, this will solve the problem.

NEXT, if you are still not pleased, write all the details-including your phone number—to:

Manager, Consumer Relations
Hotpoint
Appliance Park
Louisville, Kentucky 40225

FINALLY, if your problem is still not resolved, write:

Major Appliance
Consumer Action Panel
20 North Wacker Drive
Chicago, Illinois 60606

IMPORTANT SAFETY INSTRUCTIONS

Read all instructions before using this appliance.

WARNING—When using this appliance, always exercise basic safety precautions, including the following:

- Use **this appliance only for its intended purpose, as you will find described in this Use and Care Book.**

- **This dishwasher must be properly installed and located in accordance with the Installation Instructions before it is used.** If you did not receive an Installation Instructions sheet with your dishwasher, you can obtain one by contacting the service location nearest you.

- This appliance must be connected to a grounded metal, permanent wiring system; or an equipment-grounding conductor must be run with the circuit conductors and connected to **the** equipment-grounding terminal or lead of the appliance.

- Connect to a properly **rated**, protected and **sized** power-supply circuit to avoid electrical overload.

- **Do not store or use combustible materials, gasoline or other flammable vapors and liquids in the vicinity of this or any other appliance.**

- Use **only** powder or liquid detergents or wetting agents recommended for use in a dishwasher.

- **Do not wash plastic items unless marked “dishwasher safe” or the equivalent.** For plastic items not so marked, check the manufacturer’s recommendations.

- Load light plastic items so they will not become dislodged and drop to the bottom of the dishwasher—they might come into contact with the heating unit and be damaged.

To minimize the possibility of injury.

- When loading items to be washed:

- A. Locate sharp items so that they are not likely to damage the door seal, and

- B. Load sharp knives with the handles up to reduce the risk of cut-type injuries.

- Do not touch the heating element during or immediately after use.

- Do not operate your dishwasher **unless all enclosure panels are properly in place.**

- Do not tamper with controls.

- Do not abuse, sit on, or stand on the door or dish rack of the dishwasher.

- Close supervision is necessary if this appliance is used by or near children. Do not allow children to play inside, on or with this appliance or any discarded appliance. Dispose of discarded appliances and shipping or packing material properly. Before discarding a dishwasher, remove **the** door of the washing compartment.

- Keep all washing detergents and wetting agents out of the reach of children, preferably in a locked cabinet. Observe all warnings on container labels to avoid personal injury.

- To minimize the possibility of electric shock, disconnect this appliance from the power supply before attempting any maintenance. Note: **Turning** the control dial to **the OFF** position does not disconnect the appliance from the power supply. We recommend having a qualified technician service your appliance.

WARNING—HYDROGEN GAS

is produced by the chemical action within your water heater. It can accumulate in the water heater and/or water pipes if hot water has not been used for a period of two weeks or longer. **HYDROGEN GAS IS EXPLOSIVE.** To prevent the possibility of damage or injury, if you have not used hot water for two weeks or more, or moved into a residence in which the hot water system may not have been used for some time, turn on all hot water faucets and allow them to run for several minutes before using any electrical appliance which is connected to the hot water system. This will allow any hydrogen gas to escape. Also, since the gas is flammable, do not smoke or use an open flame or appliance during this process.

SAVE THESE INSTRUCTIONS

How to operate the dishwasher

STEP 1

Load your dishwasher with dishes, silverware, pots, pans, bowls, etc. according to instructions on pages 12 and 13.

STEP 2

Add detergent to the detergent dispenser.

Use rinse aid agent to help prevent spotting. (See page 10.)

Close and latch the dishwasher door.

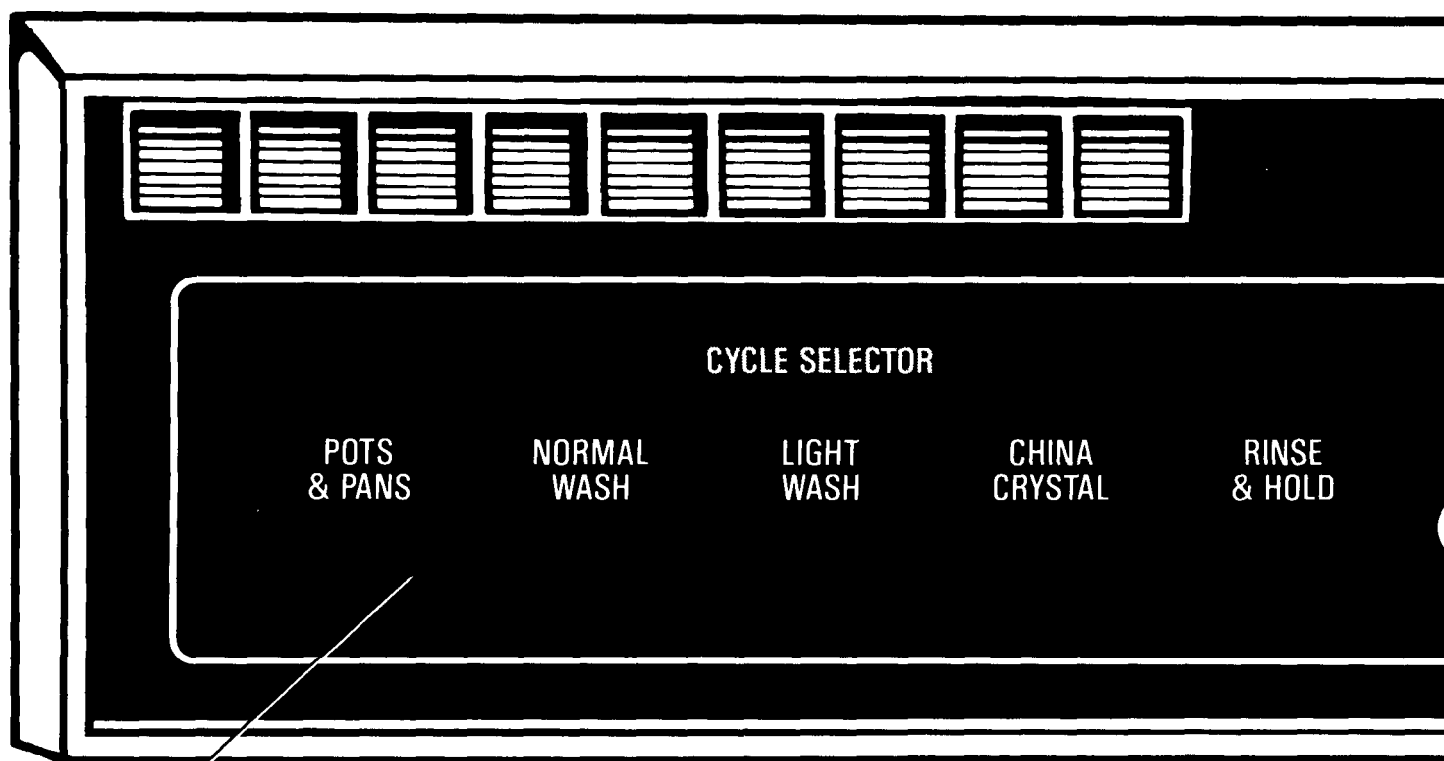

STEP 3

Select desired wash cycle

Touch the center of the pad.

• **POTS AND PANS**—For items such as pots, pans and casseroles. Everyday dishes may be included.

• **NORMAL WASH**—For loads of everyday dishes with medium soils. Designed to yield high performance on normal loads.

• **LIGHT WASH**—For most loads of everyday dishes with light soils or soils that have not dried on. It saves hot water over the higher performance cycles, thus saving energy.

• **CHINA-CRYSTAL**—For lightly soiled china and crystal. The wash action is softened by pumping air along with the water to protect your delicate items. *Pre-rinse dishware before loading.* Follow loading instructions on pages 12 and 13.

• **RINSE & HOLD**—For rinsing partial loads which will be washed later. *Do not use detergent.*

To change a setting, just touch desired pad.

Your dishwasher is now automatically programmed. A number in the **DISPLAY PANEL** (at right) will tell you how long the cycle will take.

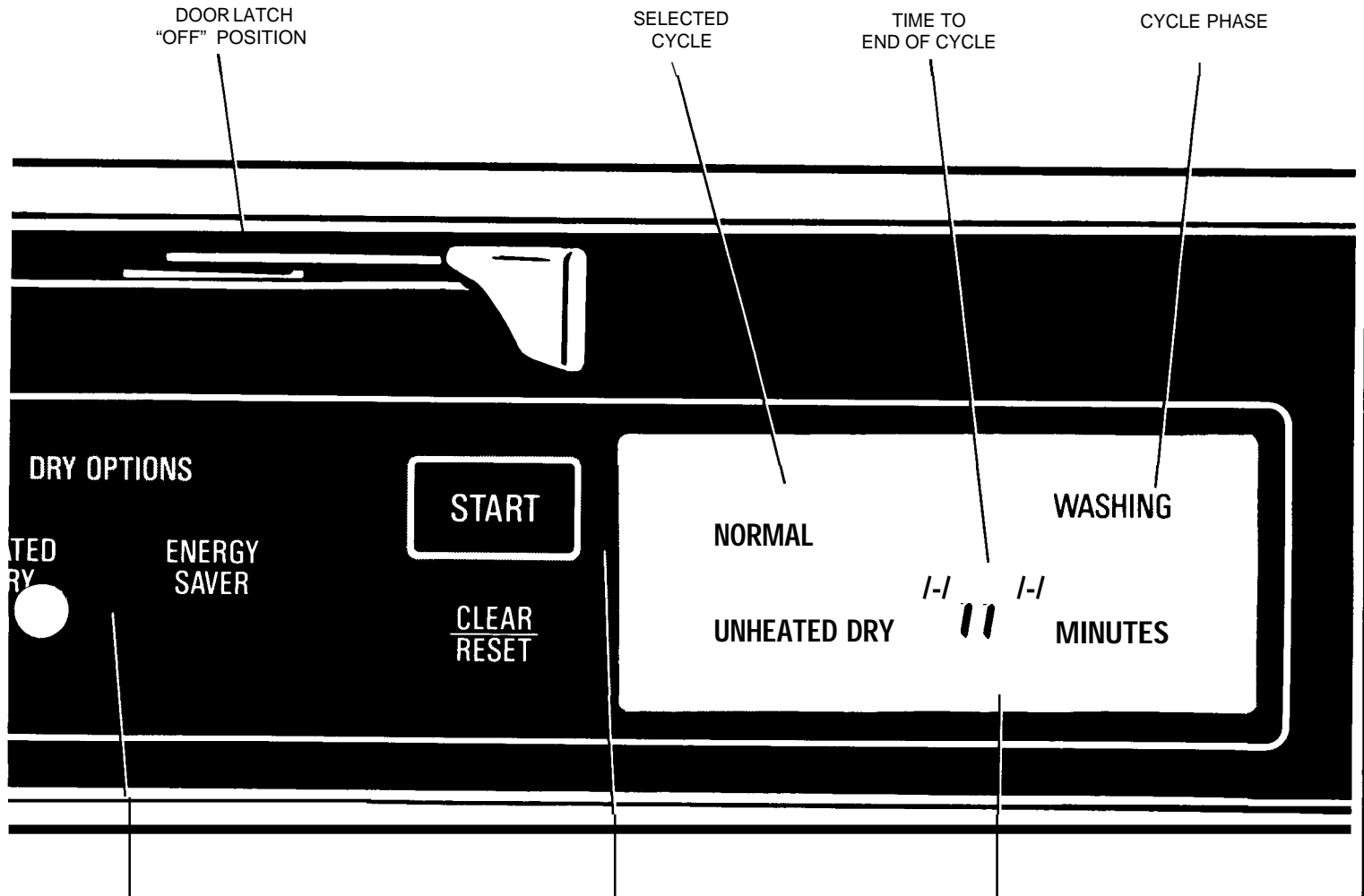

STEP 4

Select a drying option

- **HEATED DRY.** Provides faster drying. Can be changed while cycle is running.
 - **ENERGY SAVER.** Shuts off drying heater. Dishes air-dry naturally. It takes longer, but saves energy. You can prop door open about 3 inches after motor stops to speed drying. Excellent for overnight drying.
- Energy Saver helps reduce electrical energy used by this model approximately 7%.

STEP 5

Start the dishwasher

- When you're ready to wash dishes, touch the **START** pad. There is a time delay between start-up and water fill so you will not hear any wash action right away. Dishwasher will proceed through your entire program and turn off automatically.

To change a cycle after washing **starts**, touch the **CLEAR/RESET** pad to cancel cycle. After water is pumped out and motor stops, you can reprogram and restart the dishwasher.

Display Panel

This panel tells you what is happening in the dishwasher and can alert you to some possible problems.

Information displayed:

- Selected wash cycle
- Selected dry option
- Minutes to end of cycle
- Cycle phase, such as **WASHING**, **RINSING** or **DRYING**
- Diagnostic codes to alert you to possible problems

See pages 7-9 for explanation of displays and codes.

Dishwashing shortcut

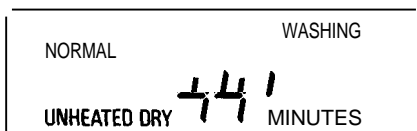

The dishwasher remembers your last cycle* so you don't have to reprogram each time.

When the dishwasher is loaded and the door is latched, the control panel will display the last settings you selected.

If you don't want to change any of the settings, simply touch START.

*If there has been a power failure, NORMAL WASH and HEATED DRY will automatically be programmed. Make any new selections as desired and touch START.

What happens in each cycle

WASH CYCLES	Water Use (Approx.)	Cycle Sequence						Wash Cycle Time (Approx.)
		Pre-Wash/Pre-Rinse	Pre-Rinse	Pre-Rinse	Main Wash	Rinse	Rinse	
POTS & PANS	11.0 gal.	Pre-Wash/Pre-Rinse	Pre-Rinse	Pre-Rinse	Main Wash	Rinse	Rinse	*64 minutes
NORMAL WASH	11.0 gal.	Pre-Wash/Pre-Rinse	Pre-Rinse	Pre-Rinse	Main Wash	Rinse	Rinse	*44 minutes
LIGHT WASH	9.3 gal.	Pre-Rinse	Pre-Rinse	Main Wash	Rinse	Rinse		*40 minutes
CHINA-CRYSTAL	7.7 gal.	Pre-Rinse	Main Wash	Rinse	Rinse			41 minutes
RINSE & HOLD	3.7 gal.	Pre-Rinse	Pre-Rinse					10 minutes

*unextended times. These cycle times may be increased up to 15 minutes if necessary for your dishwasher to heat the water to proper temperature for good washability.

Dry Options:









HEATED DRY. Available on all wash cycles except RINSE & HOLD. Add 33 minutes to wash cycle time.

ENERGY SAVER DRYING. Drying heater is turned off. Dishes dry naturally.

The DISPLAY PANEL tells you what's happening

DISPLAY	WHAT IT MEANS
NUMERALS FROM 1 to 99	Number of minutes left in cycle.
POTS & PANS	Indicates POTS &PANS cycle.
NORMAL	Indicates NORMAL WASH cycle.
LIGHT WASH	Indicates LIGHT WASH cycle.
CHINA	Indicates CHINA-CRYSTAL cycle.
RINSE & HOLD	Indicates RINSE &HOLD cycle. Remains on until the door is unlatched.
UNHEATED DRY	Indicates ENERGY SAVER Drying Option.
HEATED DRY	Indicates HEATED DRY Drying Option.
WASHING	Displayed during Pre-wash, Pre-rinse and Main Wash periods.
RINSING	Displayed during Rinse periods following the Main Wash.
DRYING	Indicates HEATED DRY has been selected.
HEATING	Indicates water being heated—in wash period—to temperature necessary for good washability. The minutes countdown is on hold for up to a maximum of 15 minutes when HEATING is displayed.

The DISPLAY PANEL tells you if certain things are wrong

DISPLAY	WHAT IT MEANS	WHAT TO DO
	Electrical power has been interrupted to the dishwasher but is now back on.	<p>IF DISHWASHER WAS IN USE WHEN THE POWER FAILURE OCCURRED:</p> <ol style="list-style-type: none"> 1. Unlatch the door. If the detergent cup is open, add detergent and close the cup. 2. Relatch the door and touch "START" then immediately touch "CLEAR/RESET" (This will pump any remaining water out of the machine.) 3. Select the desired cycle and rerun the load. <p>IF DISHWASHER WAS <i>NOT</i> IN USE:</p> <ol style="list-style-type: none"> 1. Latch door. 2. Select desired cycle. 3. Run cycle when desired.
	The dishwasher is taking longer than normal to drain the water out. This is usually caused by a blockage in the drain air gap (see page 18), a kink in the drain hose, or a stopped up drain pipe.	<p>This dishwasher is designed to automatically compensate for longer than normal drain times, but cycle time will be extended. If this code continues to appear frequently then:</p> <ol style="list-style-type: none"> 1. Clean the air gap (see page 18). 2. Check for a kink in the drain hose. 3. Check plumbing for slow or stopped up drains. (NOTE: Warranty service does not cover household drain problems.)
	Similar to blocked drain as explained above, but the  indicates that the drain is so clogged that the dishwasher cannot continue to operate in a satisfactory manner. Dishwasher will stop.	<p>Locate and remove the blockage in the drain system as explained above. To pump any remaining water out of the machine:</p> <ol style="list-style-type: none"> 1. Latch door. 2. Select any cycle. 3. Touch "START" and then immediately touch "CLEAR/RESET" (NOTE: Warranty service does not cover household drain problems.)
	Dishwasher will not go into a drain out period. Dishwasher will stop.	Restart the cycle. If  repeats, call for service.
	There is too much water in the dishwasher. If  appears after a power failure, this is normal and the dishwasher will correct itself.	<p>The dishwasher is designed to automatically pump out extra water as long as the door is latched. When you hear the motor stop running:</p> <ol style="list-style-type: none"> 1. Unlatch the door and see if all the water is gone. (It is normal for a small amount of water to remain in the bottom of tub to keep the water seal lubricated.) 2. If you see water entering the dishwasher, close and latch the door. Shut off the water supply to the dishwasher. 3. If water is gone and no water is entering the dishwasher, restart cycle. 4. If  repeats, shutoff the water supply to the dishwasher. Call for service.

DISPLAY	WHAT IT MEANS	WHAT TO DO
<p style="text-align: center; font-size: 2em;">E5</p>	<p>This can be caused by either of these reasons:</p> <p>Not enough water is entering the dishwasher.</p> <p style="text-align: center;">or</p>	<p>Unlatch the door. If there is no water in the bottom of the dishwasher, check the water supply to the dishwasher.</p> <ul style="list-style-type: none"> ● Is the dishwasher water supply turned on? (Valve usually located under the sink.) ● Is the household water supply turned on? ● If you use well or cistern water, is the supply adequate? <p>If the water supply is adequate, try the cycle again. If E5 repeats, call for service.</p>
	<p>The drain pump could be temporarily blocked (usually caused by food particles such as cereal).</p>	<p>Unlatch the door. If there is standing water in the bottom of the dishwasher, relatch the door. Touch “START,” then immediately touch “CLEAR/RESET” to start the pump. If E5 continues to appear, you may need to do this several times to breakup the blockage.</p>
<p style="text-align: center; font-size: 2em;">E1</p>	<p>The temperature sensor in the dishwasher is not functioning properly. Dishwasher may continue to be used, but it will not heat water automatically.</p>	<p>The temperature sensor needs to be replaced. Call for service.</p> <p>NOTE: You may continue to use your dishwasher. For best results, adjust your household water heater thermostat to 140°F.</p>

Before you call for service

- . Try the cycle again to see if the Code reappears. The dishwasher may correct itself.
- . Electronic controls can be affected by outside interference.
- Sometimes shutting off the power to the dishwasher (at the fuse or circuit breaker) will correct the problem.
- Restore power after about **five** seconds and try the cycle again.
- . Check the chart above for things you can do to correct the problem.



The econo-120 system

To get dishes clean and dry you need hot water. To help you get water of the proper temperature, your dishwasher has a water heating feature that automatically senses the temperature of the water in the wash cycle and heats it, if necessary, to the proper temperature. This water heating feature may allow you to turn down your household water heater and save energy if you're willing to let the dishwasher run a little longer while it heats water to the proper temperature. For good washing and drying, the entering water must be at least 120°F. To prevent dish damage, inlet water should not exceed 150°F.

How to test water temperature: Check your water temperature inside your dishwasher with a candy or meat thermometer.

Let the dishwasher run through one fill and pump out cycle, then let the dishwasher fill with water the second time.

When you hear the water stop filling, **unlatch** the door and slowly open it.

Measure the **temperature** of the water in the bottom of the tub this way:

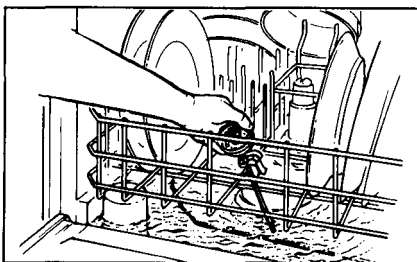

Remove the silverware basket and place a candy or meat thermometer in the water **towards** the middle of

the tub. If the temperature is less than 120°F, you will not get good washing results. Higher water temperature is needed to dissolve grease and activate powder detergents.

Helpful hints: If outside temperatures are unusually low, or if your water travels a long distance from water heater to dishwasher, you may need to set your water heater's thermostat up. If you have not used hot water for some time, the water in the pipes will be cold. Turn on the hot water faucet at the sink and allow it to run until the water is hot. Then start the dishwasher. If you've recently done laundry or run hot water for showers, give your water heater time to recover before operating the dishwasher.

To improve washability if the water is less than 120°F. and you cannot adjust your water heater: Select a longer cycle and fill both detergent cups at least half-full with detergent.

How to use a rinse agent.

A rinse agent makes water flow off dishes quicker than usual. This lessens water spotting and makes drying faster, too.

For best **dishwashing** performance, use of a rinse agent such as JET-DRY brand is recommended.

Rinse agents come in either liquid or solid form. Your dishwasher's dispenser uses the liquid form.

How to fill the rinse agent dispenser. Unscrew the cap. Add the liquid rinse agent until it just reaches the bottom of the lip inside the dispenser opening. Replace the cap. The dispenser automatically releases the rinse agent into the final rinse water.

If you accidentally **spill:** Wipe up the rinse agent with a damp cloth. Don't leave the spill in the dishwasher. It can keep your detergent from working.

If you can't **find any rinse agent**, write:

BENCKISER CONSUMER PRODUCTS, INC.
("JET DRY")
411 W. Putnam Ave.
Greenwich, CT 06830

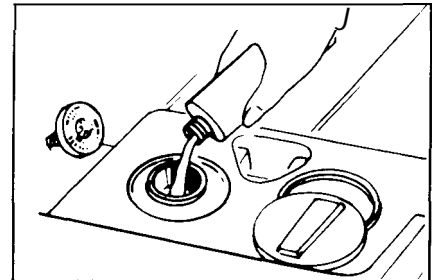

Your dishwasher's rinse agent container holds 4 1/2 ounces. This should last about 3 months. Fill as needed. Do not overfill.

How to choose and use detergent.

First, use only powder or liquid detergents specifically made for use in dishwashers. Other types will cause oversudsing.

Second, check the phosphate content. Phosphate helps prevent hard-water materials from forming spots or film on your dishes. If your water is hard (7 grains or more), your detergent has to work harder. Detergents with a higher phosphate level will probably work better. If the phosphate content is low (8.7% or less), you'll have to use extra detergent with hard water.

Your water department can tell you how hard your water is. So can your county extension agent. Or your area's water softener company. Just call and ask them how many "grains of hardness" there are in your water.

How much detergent should you use? That depends. Is your water "hard" or "soft"? With hard water, you need extra detergent to get dishes clean. With soft water, you need less detergent.

Too much detergent with soft water not only wastes money, it can be harmful. It can cause a permanent cloudiness of glassware, called "etching." An outside layer of glass is etched away! Of course, this takes some time. But why take a chance when it's easy to find out the hardness of your water.

Keep your detergent fresh and dry. Under the sink isn't a good place to store detergent. Too much moisture. Don't put powder detergent into the dispenser until you're ready to wash dishes, either. (It won't be fresh OR dry.)

If your powder detergent gets old or lumpy, throw it away. It won't wash well. Old detergent often won't dissolve.

If you use a liquid dishwasher detergent, these precautions are not necessary because liquid detergents don't "lump" as they age or come in contact with water.

You'll find two detergent dispensers on the inside door of your dishwasher. Two, because some cycles use two washes.

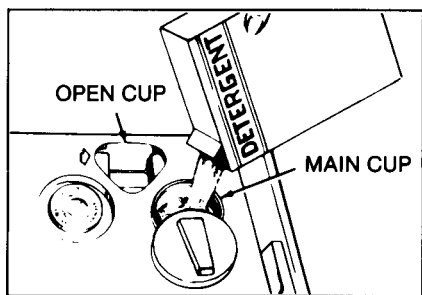

See "Detergent Usage Guide" below.

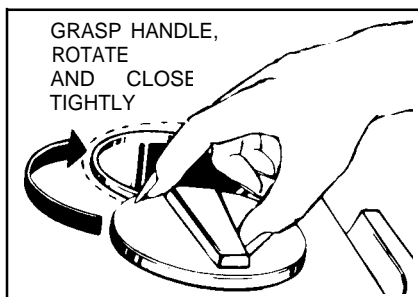

Always close the main cup tightly. When it is firmly latched you will hear a clicking sound. It is not necessary to overtighten.

NOTE: Detergent cup maybe opened manually with no harm. Turn handle counterclockwise until it releases. A snapping sound is normal when it opens.

How to prepare the dishes for washing

If this is your first dishwasher, or if you're replacing a much older model, you may wonder how much preparation your dishes need. Actually very little. Pre-rinsing of normal food soils is not necessary. With common sense and a little practice you'll soon know what foods to remove. Here are some guidelines:

1. Scrape off bones, seeds, skins, toothpicks and other hard solids. It is also best to remove hard shelled vegetables, meat trimmings, leafy vegetables and crusts. Remove excessive quantities of oil or grease.

2. Remove large quantities of any food. Your dishwasher has a built-in soft food disposer that pulverizes soft food bits and flushes them away. It can handle **small amounts** of soft foods, but large amounts of food will be difficult to handle.

3. Try to remove food scraps and place dishes in dishwasher before soil has a chance to dry and become hard. Dishes with dried-on soil are more difficult to wash and may not come clean in the NORMAL WASH cycle. Remember to use your RINSE & HOLD cycle for small "holding" loads.

Note: The foods mentioned above are for examples only. Other foods not mentioned may also need to be removed from your dishes. You may also want to consider removing foods such as mustard, mayonnaise, vinegar, lemon juice and other foods that can cause discoloration of stainless steel if allowed to remain on dishes for a long period of time.

When using the POTS & PANS cycle, less preparation is required before loading. The POTS & PANS cycle can wash heavily-soiled dishes and remove dried-on and baked-on soils from pots, pans and casseroles. Items with burned-on soils may not come clean. And the dishwasher cannot remove burn marks or restore fading caused by overheating during cooking.

Detergent Usage Guide (powder or liquid)

CYCLES	SOFT WATER (0-3 grains hardness)		MEDIUM WATER (3-7 grains)		HARD WATER (7-12 grains*)	
	Main Cup	Open Cup	Main Cup	Open Cup	Main Cup‡	Open Cup‡
POTS & PANS and NORMAL WASH cycles	1 Tablespoon minimum	+ 1 Tablespoon minimum	Half Full	+ Half Full	Completely Full	+ Completely Full
CHINA-CRYSTAL and LIGHT WASH cycles	1 Tablespoon minimum	None	Half Full	None	Completely Full	None
RINSE & HOLD cycle	Use no detergent		Use no detergent		Use no detergent	

*12 grains and up is extremely hard water. A water softener is recommended. Without it, lime can build up in the water valve. The water valve may stick while open and cause flooding.

‡Filled Main Cup holds 3 tablespoons; Filled Open Cup holds 2 tablespoons.

How to load your dishwasher

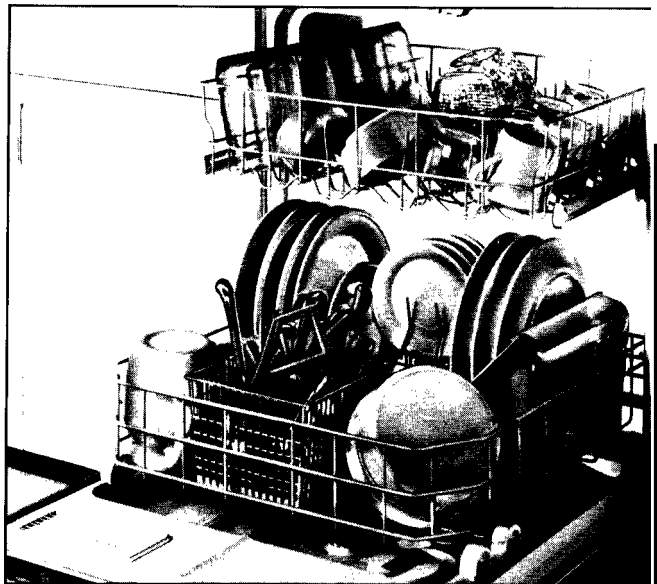

This is a random mixed load, the most common type you will have.

Make sure dishes are properly loaded to insure that water can reach the soiled surfaces. The wash arm in the bottom sprays water up. The tower that rises in the center sends water out over the dishes to wash the items in the upper rack. A spray arm in the top washes down also. Make sure to place tall items to the outside so the upper wash arm is not blocked.

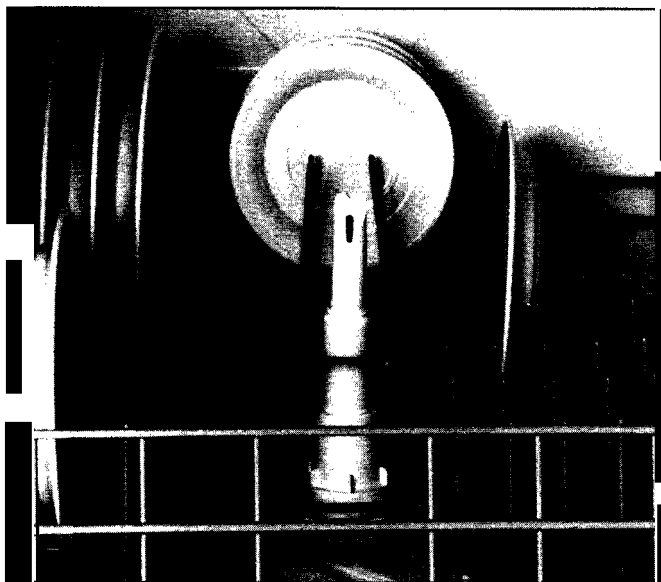

WATCH OUT FOR THIS.

The wash tower rises through the center of the bottom rack during the wash and rinse portions of the cycle. Don't block it or load tall things next to it. Also, be careful not to let a portion of an item such as a pot or dish handle extend through the bottom rack. This could block the wash arm and cause poor washing results.

How to load the TOP RACK

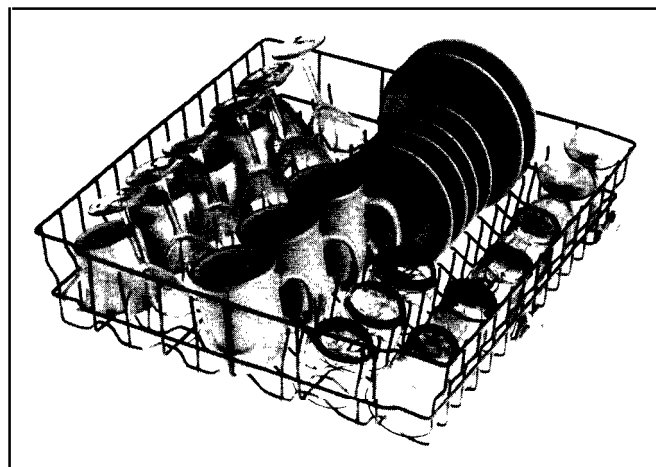

The top rack is best for glasses, cups and saucers. Cups and glasses fit best along the sides. This is the place for dishwasher-safe plastics, too. Make sure small plastic items are lodged in tightly so they can't fall onto the Calrod® heating unit. Arrange stemware so that it cannot move easily. Don't let the glasses touch each other.

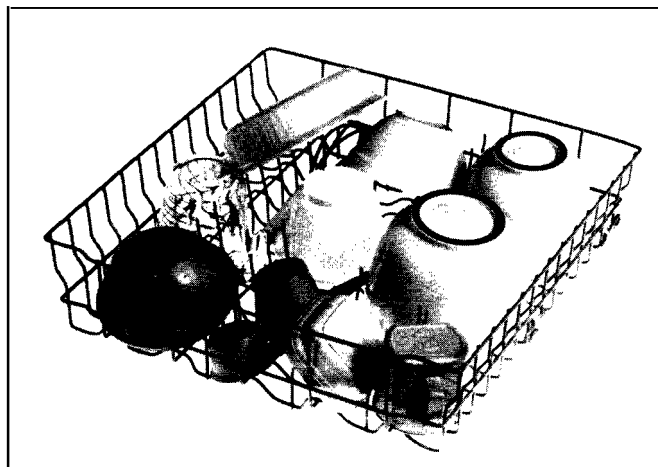

This rack is ideal for dishwasher-safe plastics. When loading, place plastic items along the back and be sure that each plastic tumbler is secured over two fingers. This will prevent dislodging; tumbler will not fall through rack onto heating unit.

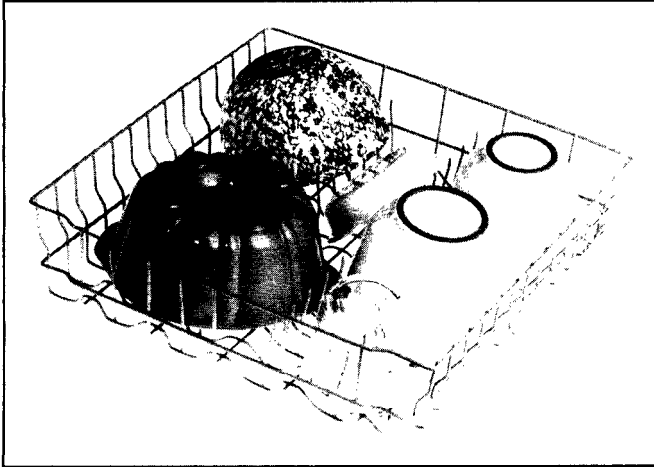

Sauce pans, mixing bowls and other small items may be placed—face down—in the top rack. The top rack is handy for all kinds of odd shapes.

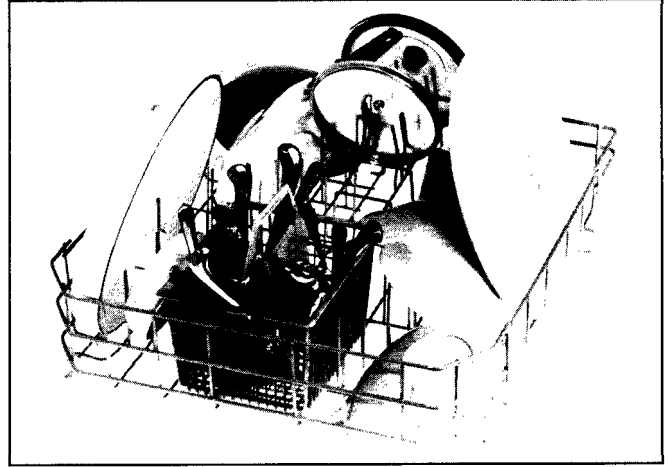

Load platters, pots, pans and bowls along the sides, in corners or in the back. All large items, such as pitchers, salad bowls and mixing bowls, should be washed in the lower rack.

How to load the BOTTOM RACK

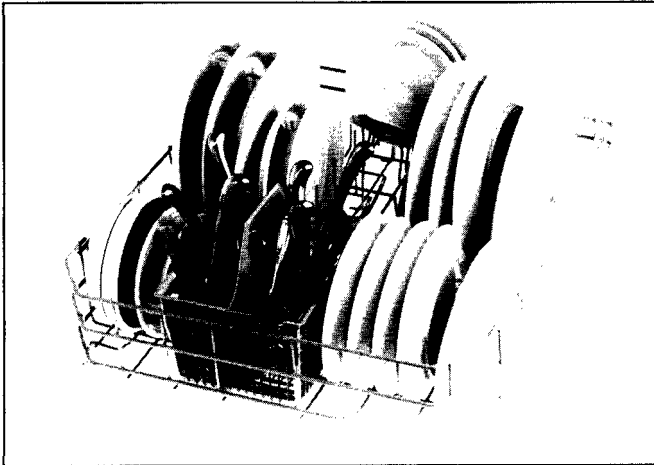

Fit plates and saucers between the pins. Place items so that water and detergent from wash arm can reach soiled surfaces.

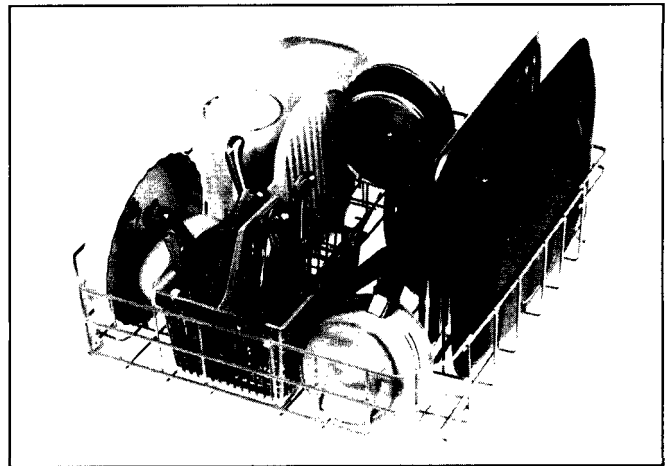

Heavily soiled pots, pans and casseroles **MUST** be loaded in the bottom rack, facing down. Prop broiler pans and racks along the edge.

Put flatware in the removable basket with handles up to protect your hands. Mix knives, forks and spoons so they don't nest together. Distribute evenly. Small plastic items, such as measuring spoons and lids from small containers are not recommended for automatic dishwashing. If placed in the dishwasher, they should go in the bottom of silverware basket with silverware on top.

Precaution!

Take out anything that may fall or extend through the bottom of the basket.

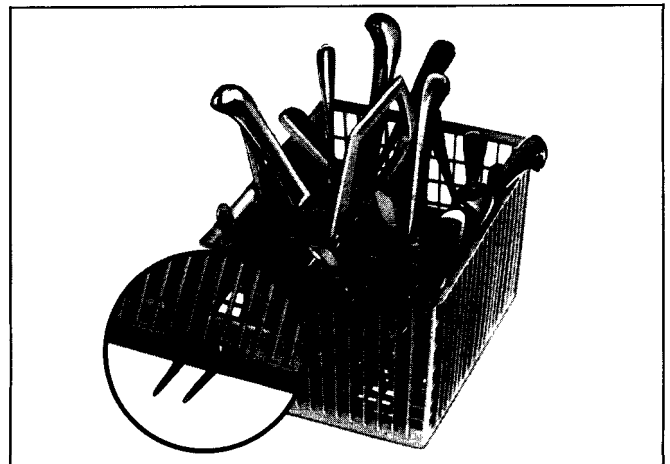

What you can usually wash safely in your dishwasher. And what you can't.

Material	Usually Safe	Exceptions (not safe)	Special Instructions
Aluminum	YES	Some colored anodized aluminum can fade.	Some darkening or spotting possible. Remove by scouring with soap-filled steel wool pads.
China/ Stoneware	YES	Antique, metal-trimmed, hand-painted or over-the-glaze patterns fade. Gold leaf will discolor.	If in doubt, check with the manufacturer. Or test wash one piece daily for at least a month. Compare with the rest of the set.
Crystal	YES	Antique, metal-trimmed or hand-painted patterns fade. Gold leaf will discolor.	Load securely to prevent movement. Select CHINA-CRYSTAL cycle. Check manufacturer's instructions for your crystal.
Non-dishware items—such as electronic air cleaner filters, furnace filters, paint brushes, etc.	NO		Do not wash in dishwasher. Damage to dishwasher and discoloration or staining of dishwasher may result.
Glass	YES	Milk Glass may yellow.	
Iron	NO	Iron will rust.	
Pewter	NO	Pewter tarnishes.	
Plastics	YES		If it doesn't say DISHWASHER SAFE, test one piece in the top rack before dishwashing an entire set.
Stainless steel	YES		Rinse if not washing immediately. Salty or acid foods can stain if left on.
Sterling Silver and Silver plate	YES	Don't put in same silverware basket with stainless steel. Contact between metals can damage silver. Don't wash copper utensils in the same load. Silver may get a brown film . Adhesive used to attach some hollow-handle knives can loosen.	Rinse if not washing immediately. Salty or acid foods can stain if left on. Dry detergent can cause difficult-to-remove black spots. Place in back section of silverware basket to avoid exposure to detergent from the detergent cup.
Non-stick coatings	YES		After washing, wipe the non-stick coating area with vegetable oil to keep it from losing its non-stick quality.
Tin	NO	Tin can rust.	
Wood	NO	Wood can warp, crack or lose its finish with any type washing.	

Forget a dish? Here's when you can add it.

Add dishes any time during the **RINSE & HOLD** cycle. With other wash cycles, you can add dishes at any time **BEFORE** the **WASHING** signal light goes off.

However, opening the door during any cycle lessens cleaning power because **the** temperature inside the dishwasher is lowered. So try to load everything at the beginning. Here's how to add a forgotten dish:

1. Push the door latch to the left. Washing will stop.

2. Wait a few seconds until the water calms. Then open the door.
3. Add dishes you've forgotten.
4. Close the door and push the latch to the far right. When the door is locked, washing will continue.



Questions? Use This Problem Solver.

PROBLEM	POSSIBLE CAUSE AND REMEDY
DISHWASHER WON'T RUN	A fuse in your home maybe blown, or the circuit breaker tripped. Replace fuse or reset circuit breaker. Remove any other appliances from the circuit.
UNUSUAL NOISE	Utensils may not be secure on rack pins, or something small may have dropped from the rack. Water is causing utensils to rattle. Make sure everything is securely placed in dishwasher.
DISHES DON'T DRY	Make sure inlet water temperature is correct. (See page 10.) Unload the bottom rack first. Water from dishes in the top rack maybe spilling into the bottom rack. Check for improper loading. Dishes shouldn't nest together. Avoid overloading. Check the rinse agent dispenser to see that it's not empty.
UNCLEAN DISHES AND FLATWARE	Check inlet water temperature. It should be at least 120°F. (To test, see page 10.) Water pressure may be temporarily low. Turn on a faucet. Is water coming out slower than usual? If so, wait until pressure is normal before using your dishwasher. Plugged air gap. (See page 18.) Improper rack loading. (See pages 12 and 13.)
BLACK OR GRAY MARKS ON DISHES	Aluminum deposits often leave marks when they rub against other things. Remove marks with a mild abrasive cleanser.
DETERGENT LEFT IN DISPENSER CUPS	Water may not be reaching the detergent cups. Move dishes that maybe blocking the detergent cup. The dispenser cover may not be opening or may be blocked by improperly loaded items. If you used a powder detergent, open the cup and remove any caked-on detergent. If the cup still doesn't open automatically, call for service. Detergent may be old. If the powder detergent is hard or caked in the box, throw it away. The detergent may not be working well. Try another brand.

(continued next page) 

The Problem Solver (continued)

PROBLEM	POSSIBLE CAUSE AND REMEDY
<p>SPOTS AND FILMING ON GLASSES AND FLATWARE</p>	<p>Spotting can be caused by all these things:</p> <ul style="list-style-type: none"> ● Extremely hard water. (See page 10.) ● Low inlet water temperature. (To test, see page 10.) ● Overloading the dishwasher. ● Improper loading. (See pages 12 and 13.) ● Old or damp powder detergent. ● Phosphate level in detergent too low. (See page 10.) <p>. Rinse agent dispenser empty. (See page 10.)</p> <p>. Too little detergent. (See page 11.)</p> <p>Due to varying local water conditions and personal preferences, try several brands of detergents to find one that gives the best results for you. A liquid dishwasher detergent may help reduce filming.</p> <p>To remove spots and film from glassware:</p> <ol style="list-style-type: none"> 1. Remove all metal utensils from the dishwasher. 2. DO NOT ADD DETERGENT. 3. Select POTS & PANS cycle and ENERGY SAVER dry option. 4. Start the dishwasher and allow to run until “25” minutes to end of cycle is displayed. 5. Then open the door and pour 2 cups (500ml) of white vinegar into the bottom of the dishwasher. 6. Close the door and allow the dishwasher to complete the cycle. <p>If vinegar rinse doesn't work: Repeat as above, except use 1/4 cup (60ml) of citric acid crystals instead of vinegar. (Most drugstores carry citric acid crystals. If yours doesn't, call Hotpoint Factory Service.)</p> <p>Using a vinegar or citric acid crystal rinse more than twice a month? Consider a home water softener,</p>
<p>CLOUDINESS ON GLASSWARE</p>	<p>If vinegar or citric acid crystal rinse doesn't work, the cloudiness is “etching” The film cannot be removed.</p> <p>It can be prevented: Use less detergent if you have soft water. Wash glassware in the shortest cycle that will get them clean.</p> <p>Water temperature entering dishwasher exceeds 150°F.</p>
<p>YELLOW OR BROWN FILM</p>	<p>Tea or coffee can stain cups. Remove the stains by hand, using a solution of 1/2 cup bleach and 3 cups warm water.</p> <p>An overall yellow or brown film on dishes or glassware can be caused by iron deposits in water. A special filter in the water supply line is the only way to correct this problem. Your water softener company can tell you about the filter.</p> <p>Yellow film on sterling silver results when you wash copper utensils in the same load. Silver polish will usually remove this stain.</p>

PROBLEM	POSSIBLE CAUSE AND REMEDY
CHIPPING OF CHINA	<p>Rough handling can cause chipping. Load with care. Make sure glassware and china are secure and can't jar loose. (See page 12 for correct way to load glassware.) Make sure tall glasses and stemware will clear the top of the tub when you push the rack into the dishwasher. Always use the top rack for delicate items.</p> <p>Use the CHINA-CRYSTAL cycle for fine china.</p>
SMALL AMOUNT OF WATER STANDING IN THE BOTTOM OF THE TUB	<p>Water around the outlet on the tub bottom at the back of the tub is normal. It is clean water. It's there to keep the water seal lubricated.</p>
WATER WON'T PUMP OUT OF THE TUB	<p>If the entire bottom of the tub has water, you may have a drain problem. Clean the air gap, if you have one. (See page 18.)</p> <p>Check the kitchen sink. Is it draining well? You may need a plumber.</p> <p>If dishwasher drains into a disposer, run the disposer to clear. Be sure the disposer is not clogged.</p> <p>See the DISPLAY PANEL (pages 4 and 5).</p>
SUDS IN THE TUB	<p>Sudsing detergents are not meant for dishwashers. USE ONLY AUTOMATIC DISHWASHER DETERGENTS TO AVOID SUDSING.</p> <p>To remove suds from the tub: Open the dishwasher. Let suds evaporate. Add 1 gallon of cold water to the tub. Close and latch the dishwasher. To pump out water, touch START two times, then immediately touch CLEAR-RESET.</p> <p>Repeat if necessary.</p>
DISHWASHER LEAKS	<p>Suds can cause unit to overflow. That's why it's so important to use a detergent that's designed for automatic dishwashers.</p> <p>Spilling the rinse agent can cause foam during washing. This can lead to overflowing. (Wipe up accidental spill of rinse agent with a damp cloth.)</p>
CONTROL PANEL DOESN'T RESPOND TO INPUTS	<p>Shut off power to dishwasher at fuse or circuit breaker. Wait 5 seconds and restore power to dishwasher. Try input panel again.</p>

If you need more help.. call, toll free:
GE Answer Center™
800.626.2000
consumer information service

Care and Cleaning

USER MAINTENANCE INSTRUCTIONS

Clean the control panel with a **lightly dampened cloth**. Dry thoroughly. Do not use abrasives or sharp objects on the panel. They can damage it.

Clean the **outside with a good appliance polish wax**. The outside cabinet finish is durable, but it can scratch. So use no scouring pads, or harsh or gritty cleaners.

Appliance Polish Wax & Cleaner (Cat. No. **WR97X0216**) is available from **GE/Hotpoint Appliance Parts Marts**.

The inside usually takes care of itself. If it should ever need cleaning, use a mild cleansing powder. Scouring pads and harsh cleaners can mar the finish.

Not using your dishwasher in winter? Protect against freezing.

If your dishwasher is left in an unheated place during the winter, ask a service technician to:

- Cut off electric power to the dishwasher. Remove fuses or trip circuit breaker.
- . Turn off the water supply.
- . Disconnect the water inlet line from the water valve.
- . Drain water from the inlet line and water valve. (Use a pan to catch the water.)
- Reconnect the water inlet line to the water valve.
- Remove the plastic pump cover in the tub bottom and use a sponge to soak up water in the rubber boot.

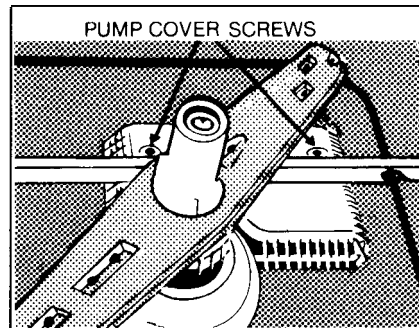

Built-in dishwashers often use an air gap. Keep it clean.

An air gap is a plumbing device. It protects your dishwasher against water backing up into it if a drain clogs. The air gap is not a part of the dishwasher. And you may not even have one. Not all plumbing codes require air gaps.

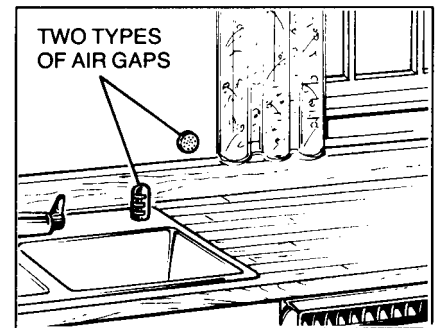

If you have an air gap, check it at least once a month. **IT IS NOT PART OF YOUR DISHWASHER. IT IS NOT COVERED IN YOUR WARRANTY.**

The air gap is easy to clean. With most types, first turn off the dishwasher, then lift off the chrome cover. Then unscrew the plastic cap and check for any build-up of grit. A toothpick makes cleaning easy.

Check the air gap any time your dishwasher isn't draining well.

How to change color panels

If you are redecorating, you can change your dishwasher's front panels to match or blend with your new colors.

The panels are held in place by the door trim and the trim on the panel below the door. Each side of each panel is a different color. Or you can paint a panel with the color of your own choice.

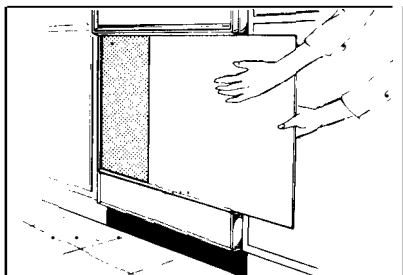

How to change the door panel:

1. Take out three trim screws on either side of the dishwasher door. Remove the side trim.
2. Slide the door panel out. (Careful—edges may be sharp.)
3. Turn the door panel around and put the color you want in front.
4. Replace the door panel, side trim and screws.

How to change the lower panel:

1. Remove four panel attachment screws. (Two above the panel, two below the panel.)
2. Remove the entire panel.
3. Take out three screws and remove the top trim.
4. Slide the door panel out.
5. Turn the panel around and put the color you want in front.
6. Replace the lower panel, top trim and screws.
7. Replace the entire panel and four attachment screws.

Do not operate the dishwasher while changing panels or when lower access panel is removed.

Note: Other color panels are available for your dishwasher.

Check the color you want on the order form below and mail it to us.

Wood panel trim kit GPF 40

contains trim and instructions for adding a decorative wood door panel and lower access panel to match kitchen cabinets. Use the order form below to order this kit.



ORDER FORM

Use this form to order, without charge, your choice of a **color panel not supplied with your dishwasher** or a **wood panel trim kit**.

Please mark **only one box**.

Harvest/Black
Door and Access Panel GPF 26

Kit GPF 40
Wood Panel Trim Kit

Coffee/Avocado
Door and Access Panel GPF 25

White/Almond
Door and Access Panel GPF 24

FOLD HERE

Name: _____

Address: _____

City: _____

State: _____ Zip Code: _____

Model No.: _____ Serial No.: _____

Date Purchased: _____

TAPE HERE

Name _____

Address _____

City _____ State _____

Zip _____

PLACE
STAMP
HERE

Hotpoint
c/o Dri-View Mfg.
4706 Allmond Ave.
Louisville, KY 40209

Notes

Notes

We'll Be There

With the purchase of your new Hotpoint appliance, receive the assurance that if you ever need information or assistance, we'll be there. All you have to do is cdl—toll-free!



GE Answer Center^a 800.626.2000

Whatever your question about any Hotpoint major appliance, GE Answer Center[®] information service is available to help. Your cdl—and your question—will be answered promptly and courteously. And you can call any time. GE Answer Center[®] service is open 24 hours a day, 7 days a week.

In-Home Repair Service

800-GE-CARES
(800-432-2737)

Our consumer service professionals will provide expert repair service on your Hotpoint appliance, scheduled at a time that's convenient for you. Many GE Consumer Service company-operated locations offer you service today or tomorrow, or at your convenience (7:00 a.m. to 7:00 p.m. weekdays, 9:00 a.m. to 2:00 p.m. Saturdays). Our factory-trained technicians know your appliance inside and out—so most repairs can be handled in just one visit.



Service Contracts

800-626-2224

You can have the secure feeling that GE Consumer Service will still be there after your Hotpoint product warranty expires. Purchase a GE contract while your warranty is still in effect and you'll receive a substantial discount. With a multiple-year contract, you're assured of future service at today's prices.

Parts and Accessories

888-626-2882

Individuals qualified to service their own appliances can have needed parts or accessories sent directly to their home, free of shipping charge! Our parts system provides access to over 47,000 Genuine Renewal Parts . . . and all are fully warranted. VISA, MasterCard and Discover cards are accepted.

User maintenance instructions contained in this booklet cover procedures intended to be performed by any user. Other servicing generally should be referred to qualified service personnel. Caution must be exercised, since improper servicing may cause unsafe operation.



Telecommunication Device for the Deaf

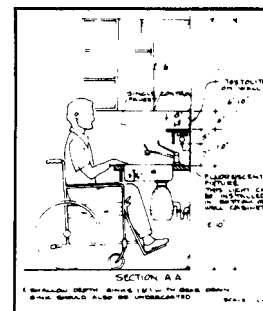

For Customers With Special Needs... 800.626.2000

Upon request, we will provide Braille controls for a variety of Hotpoint appliances, and a brochure to assist in planning a barrier-free kitchen for persons with limited mobility. To obtain these items, free of charge, call 800.626.2000.

Consumers with impaired hearing or speech who have access to a TDD or a conventional teletypewriter may call 800-TDD-GEAC (800-833-4322) to request information or service.

YOUR HOTPOINT AUTOMATIC DISHWASHER WARRANTY

Save proof of original purchase date such as your sales slip or cancelled check to establish warranty period.

WHAT IS COVERED

FULL ONEYEAR WARRANTY

For one year from date of original purchase, we will provide, free of charge, parts and service labor in your home to repair or replace **any part of the dishwasher** that fails because of a manufacturing defect.

FULL TEN-YEAR WARRANTY

For ten years from date of original purchase, we will provide, free of charge, parts and service labor in your home to repair or replace **the tub or door liner** if it fails to contain water because of a manufacturing defect such as cracking, chipping, peeling or rusting.

This warranty is extended to the original purchaser and any succeeding owner for products purchased for ordinary home use in the 48 mainland states, Hawaii and Washington, D.C. In Alaska the warranty is the same except that it is LIMITED because you must pay to ship the product to the service shop or for the service technician's travel costs to your home.

All warranty service will be provided by our Factory Service Centers or by our authorized Customer Care® servicers during normal working hours.

Look in the White or Yellow Pages of your telephone directory for HOTPOINT FACTORY SERVICE, GENERAL ELECTRIC—HOTPOINT FACTORY SERVICE or HOTPOINT CUSTOMER CARE® SERVICE.

WHAT IS NOT COVERED

- Service trips to your home to teach you how to use the product. Read **your Use and Care material**. If you then have any questions about operating the product, please contact your dealer or our Consumer Affairs office at the address below, or call, toll free: GE Answer Center®
800.626.2000
consumer information service

- . Improper installation.

If you have an installation problem, contact your dealer or installer. You are responsible for providing adequate electrical, plumbing and other connecting facilities.

- . Replacement of house fuses or resetting of circuit breakers.

- Cleaning or servicing of air gap device in drain line.

- Failure of the product if it is used for other than its intended purpose or used commercially.

- Damage to product caused by accident, fire, floods or acts of God.

WARRANTOR IS NOT RESPONSIBLE FOR CONSEQUENTIAL DAMAGES.

Some states do not allow the exclusion or limitation of incidental or consequential damages, so the above limitation or exclusion may not apply to you. This warranty gives you specific legal rights, and you may also have other rights which vary from state to state. To know what your legal rights are in your state, consult your local or state consumer affairs office or your state's Attorney General.

Warrantor: General Electric Company

**If further help is needed concerning this warranty, write:
Manager—Consumer Affairs, GE Appliances, Louisville, KY 40225**

Part No. 165 D3080P148
Pub. No. 39-5207

5-90 

HOTPOINT

HDA2000M

Free Manuals Download Website

<http://myh66.com>

<http://usermanuals.us>

<http://www.somanuals.com>

<http://www.4manuals.cc>

<http://www.manual-lib.com>

<http://www.404manual.com>

<http://www.luxmanual.com>

<http://aubethermostatmanual.com>

Golf course search by state

<http://golfingnear.com>

Email search by domain

<http://emailbydomain.com>

Auto manuals search

<http://auto.somanuals.com>

TV manuals search

<http://tv.somanuals.com>