

# Hotpoint Service Offices

**SERVICE CALL:** If you have a problem with your appliance ring your local Service Office.  
**SPARES and ACCESSORIES:** To purchase spares and accessories send your Accessories Order Form to your Spares Centre. If the accessory or spare part you want is not on the form then contact your Spares Centre for prices and availability.  
 Please address all correspondence to Hotpoint Spares Centre or Hotpoint Service Office as applicable.

Service Offices and Spares Centres are open between 8.30am-5.00pm Monday to Friday, except on Public Holidays. 8.30am-12.30pm Saturdays

## EASTERN

- NORWICH:** 92 Upper St. Giles Street, NR2 1LT. Tel: Norwich (0603) 620581.
- PETERBOROUGH:** Celta Road, PE2 9JB. Tel: Peterborough (0733) 64741.
- LUTON:** 5 Crawley Road, LU1 1HX. Tel: Luton (0582) 452211.
- CHELMSFORD:** Industrial Buildings, Beehive Lane, CM2 9TE. For postal codes RM: IG Chelmsford (0245) 492433 Remainder of Essex Chelmsford (0245) 268331.

## EAST MIDLANDS

- LEICESTER:** 65 Belgrave Gate, LE1 3HR. Tel: Leicester (0533) 514455.
- WELLINGBOROUGH:** 39B Cambridge Street, NN8 1DW. Tel: Wellingborough (0933) 223669.
- NOTTINGHAM:** Ashling Street, NG2 3JB. Tel: Service Office Nottingham (0602) 862431 Spares Centre Nottingham (0602) 860387.

## LONDON and SOUTH EAST

- SUTTON:** 2 St. Nicholas Road, SM1 1EH. Tel: 081-643 0921
- HAILSHAM:** 1 Kingswood, North Street, BN27 1DQ. Tel: Hailsham (0323) 842733.
- WEMBLEY:** 68 East Lane, HA9 7PQ. Tel: Office for S. Herts and Middlesex 081-904 4399 Office for postal codes W. NW, WC, SW 1, 3, 5, 6, 7, 10 081-904 1250 N. E. EC 081-908 4722 SE and rest of SW 081-908 2511

- LARKFIELD:** Larkfield Trading Estate, New Hythe Lane, ME20 6SW. Tel: Service Office Maidstone (0622) 716571 Spares Centre Maidstone (0622) 716631.

## CHANNEL ISLANDS

— Service provided by agents The normal United Kingdom guarantees apply and all services schemes are available.  
**JERSEY:** 19 Don Street, St. Helier. Tel: (0534) 21625. Clos D'Ormes, Pontac, St. Clements. Tel: (0534) 54808.  
**GUERNSEY & SARK:** Valois Stores, Grande Rue, St. Martin, Guernsey. Tel: (0481) 38422. 15 Le Pellet, St. Peter Port, Guernsey. Tel: (0481) 23311. Lowlands, Braye Road, Vale, Guernsey. Tel: (0481) 48264.  
**ALDERNEY:** 32 High Street, Alderney. Tel: (0481) 822686.

Spares and accessories may be ordered from Hotpoint Spares Administration Dept., Celta Road, Peterborough, PE2 9JB.

Tel: Peterborough (0733) 069599.

In accordance with its policy of progressive product design, the Company reserves the right to alter specifications.

Hotpoint Ltd, Peterborough, PE2 9JB, England

# FULL INSTRUCTIONS FOR INSTALLING AND OPERATING YOUR HOTPOINT DOUBLE OVEN MODEL 6182



# Hotpoint®

- Service Office and Spares Centre
- Service Office only

## SOUTH MIDLANDS

- DIDCOT:** 224 Broadway, OX11 8RS. Tel: Didcot (0235) 817711. Spares and accessories may be ordered from either Aldridge or Wembley Centres.

## SOUTH WEST

- BRISTOL:** 3/5 Brislington Hill, Brislington, BS4 58Q. Tel: Bristol (0272) 714471.
- PLYMOUTH:** 69 Muley Plain, PL4 6JH. Tel: Plymouth (0752) 262631.
- TOTTEN:** South Hampshire Industrial Park, Salisbury Road, SO4 3SA. Tel: Service Office Totton (0703) 861081 Spares Centre Totton (0703) 867933.

## WALES

- LLANUDNO JUNCTION:** Conwy Road, LL31 9RZ. Tel: Deganyw (0492) 582626.
- BRIDGEND:** 18 Western Avenue, Bridgend Industrial Estate, CF31 3SL. Tel: Service Office Bridgend (0656) 664121 Spares Centre Bridgend (0656) 766111.

## WEST MIDLANDS

- STOKE-ON-TRENT:** West Avenue, Nelson Estate, Kidsgrove, ST7 1TN. Tel: Kidsgrove (0782) 774511.
- ALDRIDGE:** Westgate, WS9 8UX. Tel: Service Office Aldridge (0922) 743374 Spares Centre Aldridge (0922) 743377.

## IRELAND

Northern Ireland: 256 Ormeau Road, Belfast, BT7 2EZ. Tel: Belfast (0232) 647111.  
 Eire: 35/36 Arran Quay, Dublin 7. Tel: Dublin (0001) 725922.  
 Spares and accessories may be ordered from either address.

## **Before you operate your new Hotpoint Built-In/Built-Under Oven**

### **Please read these instructions fully.**

1. Ensure that the oven is installed by a qualified electrician following the instructions below.
2. For your own safety and to get the best results from your oven it is important to read through this Handbook **before** using your oven for the first time.

### **Electrical Requirements**

- Any electrical wiring must be carried out in compliance with the appropriate IEE and electricity board regulations by a qualified electrician, eg. your local electricity board or a contractor who is on the roll of the National Inspection Council for Electrical Installation Contracting (NICEIC).

- **WARNINGS – INCORRECT INSTALLATION COULD AFFECT THE SAFETY OF THE OVEN.**

- **ALL APPLIANCES MUST BE EARTHED.**
- **BEFORE CONNECTING OR INSTALLING THE OVEN THE ELECTRICITY SUPPLY MUST BE SWITCHED OFF.**

- **THE INSTALLER MUST** check that the voltage shown on the rating plate corresponds with the house electricity supply.
- The oven must be connected to a suitable double pole isolating switch, having a contact separation of at least 3 mm in all poles, placed in a readily accessible position, adjacent to the unit.
- If the oven is to be wired into a socket/connector unit this may be positioned behind the oven provided the following requirements are met:
  - i) The connector unit must not project wall more than 25 mm from the wall.
  - ii) The top of the connector must not be more than 100 mm above the base of the oven recess.
- After unpacking the oven stand it on the packing base in order to avoid damage.

### **Electrical Connections**

- Remove the terminal cover at the rear base of the oven. Pass the cable through the cable clamp and connect to the appropriate terminals provided. Allow sufficient cable so that the oven can be set down on the floor whilst still connected up. Tighten the screws on the cable clamp and replace the terminal cover. Make mains connections.

**WARNING: YOUR OVEN SHOULD NOT BE LOCATED ADJACENT TO A GAS HOB, HEATER OR EYE LEVEL GRILL, AS FLAMES FROM THE BURNERS COULD CAUSE DAMAGE TO YOUR OVEN.**

## PLEASE READ THIS BOOKLET CAREFULLY

### Contents

	Page
Before you operate your new Hotpoint Double Oven	2
Electrical Requirements	2
Installing your Oven	4-5
The main parts of your Oven	6
The Cooking Systems in your Oven	7
The Controls	8-9
The Automatic Oven Timer	10-12
Before using your Oven for the first time	13
Position of shelves	14-15
Cooking in the Top Oven – Grilling	14
– Conventional Cooking	14-15
Cooking in the Lower Oven – Conventional Cooking	15-16
– Fan Cooking	16-17
– Fan Grilling	17
Care and cleaning of the Oven	18-19
If something goes wrong	20
If it still won't work	20
Hotpoint Service Cover	21
Hotpoint Service Offices and Spares Centres	back page

### Retention of this Instruction Book

This Instruction Book must be kept handy for reference as it contains important details on the safe and proper use of the appliance.

If you sell or pass the appliance to someone else, or move house and leave it behind, make sure this Book is also provided so the new owner can become familiar with the appliance and safety warnings.

If the Book is lost or damaged a copy may be obtained from Hotpoint Ltd, Ceita Road, Peterborough, PE2 9JB.

# Installing your Double Oven

## Dimensional Requirements

Dimensions for the housing unit recess and the oven are given in Figure 1.

The housing unit **MUST** be firmly attached to the wall, using the bracket supplied, before the oven is installed.

The housing unit into which the oven is to be placed should be solid wood or have a melamine or laminate finish.

Adequate ventilation must be provided (see Figure 2). Particular attention must be paid to ensure that the air inlet and outlet areas are kept clear. Sufficient space must be left between the top of the housing unit and the ceiling to allow a free flow of air.

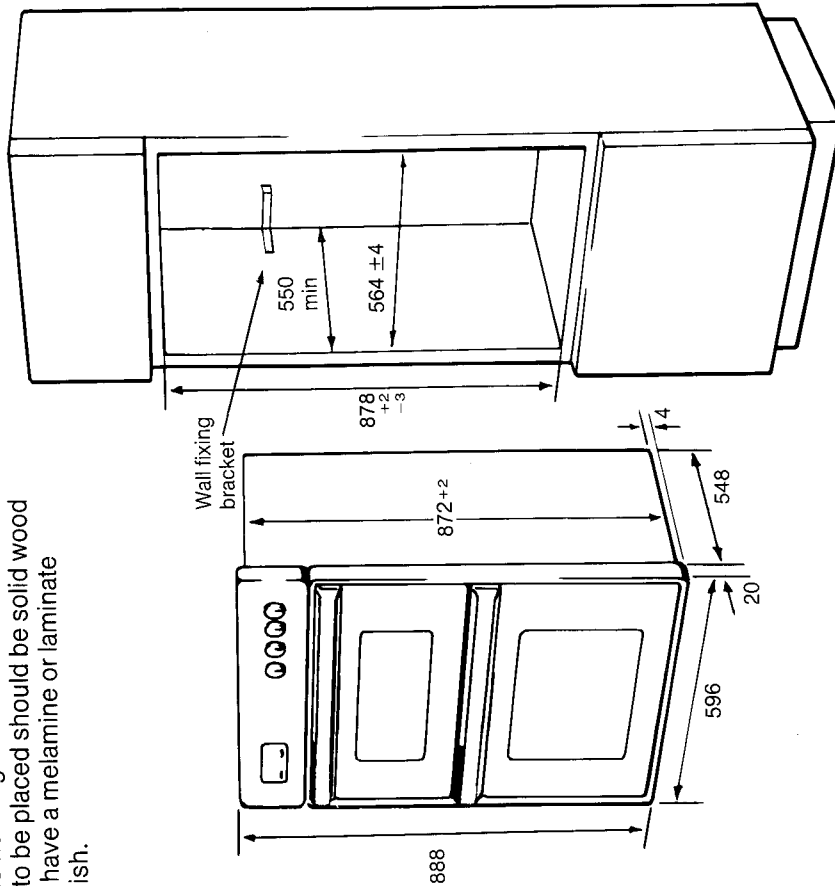

Figure 1

# Hotpoint Service Cover

## Satisfaction Guaranteed or Your Money Back

Hotpoint gives you a unique 'Satisfaction Guaranteed' promise – valid for ninety days after you have purchased your Hotpoint product. If there is a problem with your Hotpoint appliance just call your Hotpoint Service Office. If necessary we will arrange for an engineer to call. If the problem is not resolved by us under this Guarantee, Hotpoint will replace your appliance or, if you prefer, give you your money back. This Guarantee is additional and subject to the terms of Hotpoint's Five Year Parts Guarantee.

## Hotpoint's Free Five Year Guarantee

From the moment your appliance is delivered, Hotpoint guarantees it for **FIVE YEARS**.

- In the Five Years all replacement parts are **FREE** provided they are fitted by our own Service Engineer. During the first year our Engineer's time and labour is also free.
- After the first year we will charge for our Engineer's time and labour. We do, however, operate a range of Service Plans (see opposite) which for an annual payment enables you to cover any repair costs which may be necessary.
- All of our service repairs are guaranteed for twelve months in respect of our labour and any parts fitted.
- The appliance must be used in the United Kingdom and must not be tampered with or taken apart by anyone other than our own Service Engineer.
- You may, however, buy parts which can be safely fitted without specialist knowledge or equipment. The correct fitting of such parts, provided they are genuine Hotpoint spares, will not affect your Guarantee. Parts are available from our main Hotpoint Spares Centres (see back page).
- Our Guarantee does not cover the cost of any repair which is needed because of power cuts, accidents or misuse. Nor does it cover the cost of any visit to advise you on the use of the appliance. Please read the instruction book thoroughly.
- If at any time during the Guarantee period we are unable to repair your appliance, we will refund any repair costs paid to us in the previous twelve months. We will also offer you a new appliance at a reduced charge instead of a repair.
- Our Guarantee is in addition to and does not affect your legal rights.
- Should you need independent advice on your consumer rights, help is available from your Consumer Advice Centre, Law Centre, Trading Standards Department and Citizens

Advice Bureau.

- All Hotpoint servicing is done by our own Service Organisation located throughout the United Kingdom and Southern Ireland. It will be happy to deal with any problems.

## Hotpoint's Service Care

Whether you have just one or a number of Hotpoint appliances in your kitchen Hotpoint has a range of Service Schemes to give you complete peace of mind.

## Service Cover

One annual payment covers you for all repairs for **individual appliances**. If two or more appliances are covered a 20% reduction is made on each fee. There is also the option of **Service Cover with Maintenance** at an additional cost. Service Schemes are renewable each year by mutual agreement.

## Cooker Cover

One annual payment covers you for all repairs for **any number of Hotpoint Ovens, Microwaves, Hobs and Cooker Hoods** purchased. There is also the option of **Cooker Cover with Maintenance** at an additional cost.

## Kitchen Cover

One annual payment covers you for all Repairs and a Maintenance Check for **all Hotpoint appliances owned** which are less than ten years old. Kitchen Cover also covers loss of food up to the value of £250 in our refrigeration and freezer products. Any additional Hotpoint appliances purchased after you have joined **Hotpoint Kitchen Cover** will automatically be included during the current annual period of cover without any further charge.

## Appliance Registration

To ensure that you have the opportunity to benefit from any of the above Service Schemes you should complete and return immediately the Appliance Registration Form supplied with your appliance. Full details and costs of our Service Schemes together with an application form will be sent to you at the end of the first year of the guarantee.

## Annual Safety/Maintenance Checks

Hotpoint strongly recommends that all its appliances are regularly checked for electrical and mechanical safety whether or not they are covered by a Service Plan.

## Proof of Purchase

For future reference please attach your purchase receipt to this booklet and keep it in a safe place.

## Spares and Accessories

Spares and accessories can be ordered from your local Hotpoint Spares Centre (listed on the back page), using the order form enclosed.

## If something goes wrong...

First, don't panic!

There may be nothing wrong. Check the points below before calling your Hotpoint Service Office.

1. Check that the mains supply has been switched on.
2. Check that the oven timer has been set to Manual operation and not left on automatic (see pages 8 and 9).
3. Have you turned both the Lower Oven Selector and the Oven Temperature Selector to the appropriate positions?
4. If grilling have you turned the relevant Oven Thermostat to  or 'Grilling' and the Grill Selector to the required setting?

## If it still won't work...

### Contact the Service Office

If there is still a problem with your oven after checking the points mentioned previously:

1. Switch off the oven at the oven control panel.
2. Call your nearest Hotpoint Service Office or local importer (outside the UK). The telephone number is shown on the back page. Note the number down in the space below:

.....

When you contact us we will want to know the following:

1. Your name, address and post code.
2. Your telephone number.
3. Clear and concise details of the fault.
4. The model number (6182) serial number (found on the base front of the oven) and the colour.
5. The date of purchase. Enter the date here:
6. ....

Please make sure you have these ready when you call.

Hotpoint's own Service Engineer. The address and telephone number of your nearest Hotpoint Service Office is in your local telephone directory. Our spare parts are designed exclusively to fit only Hotpoint appliances. Do not use them for any other purpose as you may create a safety hazard.

## Spare Parts

Please remember your new appliance is a complex piece of equipment. 'DIY' repairs or unqualified and untrained service people may put you in danger, could damage the appliance and might mean you lose cover under Hotpoint's Parts Guarantee.

If you do experience a problem with the appliance don't take risks; call in

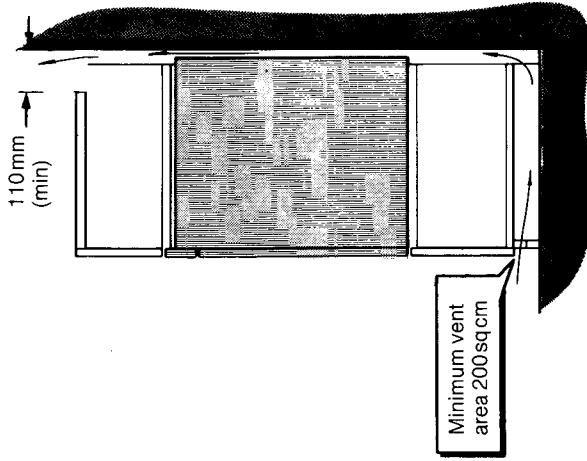

Figure 2

## Installing the Oven into the Housing Unit

Do not lift or carry the oven by the door handles. It is advisable to remove the oven doors before attempting to lift the oven.

To do this open the door fully and swing the hinge 'stops' upwards towards the installer (Figure 3). Close the door as far as the 'stop' position. Lifting the doors slightly pull them, up and away from the oven housing (Figure 4). Then lift up the oven using the handles in the side of the oven casing and push it into the recess, making sure that the connecting cable is not trapped beneath or behind. Centralise the oven within the housing unit and secure through the side trims using two of the black screws supplied. Replace the oven doors, ensuring that the 'stop' has been pushed into position.

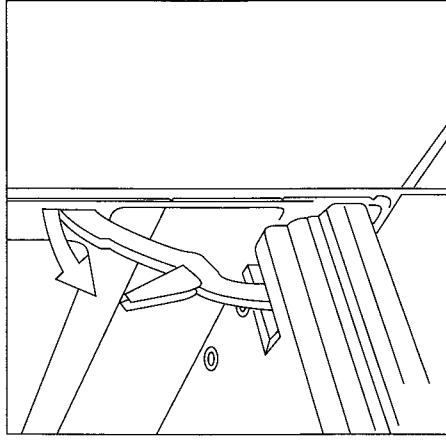

Figure 3

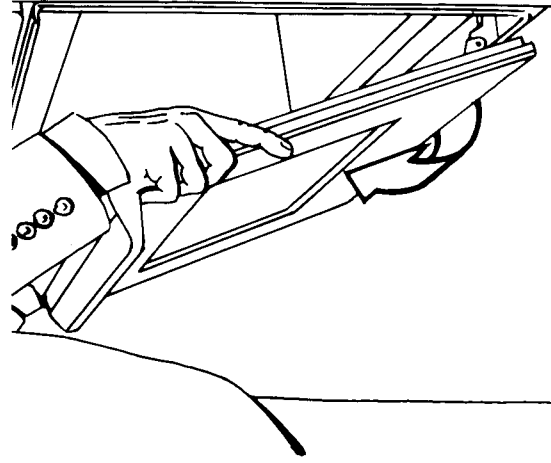
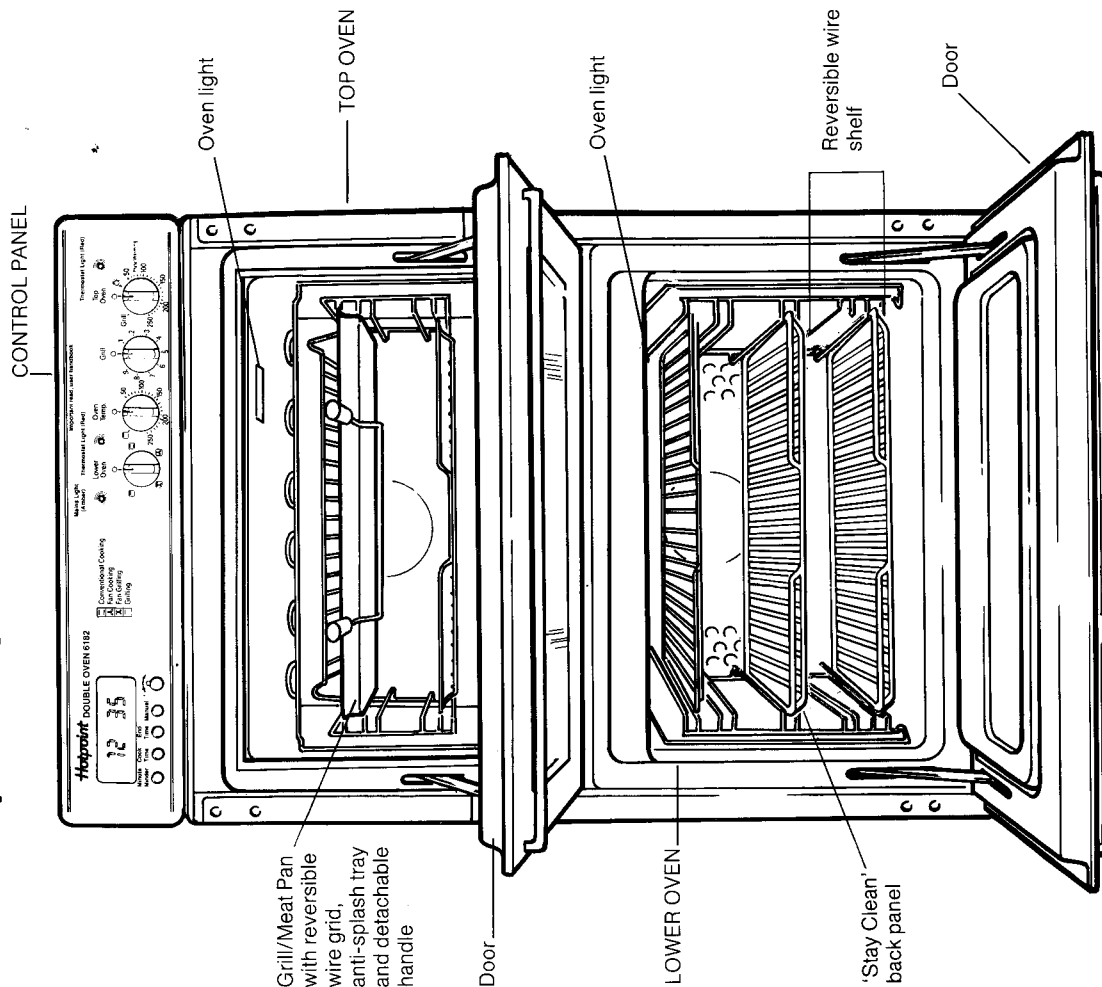

Figure 4

# The main parts of your Double Oven



## Oven furniture

Should include:

- 4 wire shelves, 1 grill shelf, 1 grill/meat pan with wire grid anti splash tray and detachable handle.

**WARNING: DO NOT TOUCH THE GLASS DOORS WHEN THE OVEN IS IN USE AS THESE AREAS CAN BECOME HOT.**

However, if higher cooking

temperatures are not regularly used then it may be necessary, in order to prevent heavy soiling, to run the ovens at maximum temperature for at least two hours, from time to time.

Should it be necessary the 'Stay Clean' side and roof panels can be removed. The side and roof liners simply slide out.

To remove the metal shelf fittings from the side liners simply push the metal fittings upwards until the base section is disengaged from the retaining holes. To replace the fitting place the longer locating ends into the retaining holes at the top of the liner and allow the fitting to slide down to engage the base section in the retaining holes.

The 'Stay Clean' liners can then be washed in warm soapy water followed by rinsing in clear water. Dry well with a soft cloth.

**NOTE: DO NOT use enzyme washing powder, harsh abrasives or chemical oven cleaners of any kind.**

**DO NOT wash the 'Stay Clean' liners in a dishwasher.**

## Oven Fittings

The shelf fittings can be removed as described previously. They and the wire shelves can be cleaned either in a dishwasher or by using a fine steel wool soap pad to remove stubborn stains.

## Oven Interiors

To clean the oven interiors remove all the oven fittings and if necessary the 'Stay Clean' liners.

All types of oven cleaners can be used, but **DO NOT** allow abrasive cleaners or oven spray to come into contact with the 'Stay Clean' liners, oven surround or trims. Use a fine steel wool soap pad to remove stubborn stains.

## How to replace the oven lights

Should the oven lights fail to work, **switch off** the mains supply to the oven. Access to the bulbs can be gained after first removing the lamp cover by turning anti-clockwise. The bulb can then be unscrewed and replaced by one of a similar type (Part No. 613002) which can be obtained from your nearest Hotpoint Service Centre (see back cover).

**NOTE: Additional shelves can be obtained from your local Hotpoint Spares Centre, listed on the back page.**

## Care and cleaning of the Double Oven

**WARNING: BEFORE CLEANING SWITCH THE OVEN OFF AT THE COOKER CONTROL PANEL AND ALLOW IT TO COOL.**

### Cleaning the outside

Clean the outside by wiping with a damp cloth using a small amount of detergent, followed by wiping down with a dry clean cloth.

**Note: DO NOT use scouring pads or abrasive powder which will scratch the glass.**

### Cleaning the Oven Doors

Both doors can be removed for cleaning. To do this, open the door and swing the hinge 'stops' upwards and towards the user (Figure 5). Close the door as far as the 'stop' position. Lifting the door slightly, pull it up and away from the oven housing (Figure 6).

Replace the oven doors after cleaning and ensure that the 'stop' has been pushed into position.

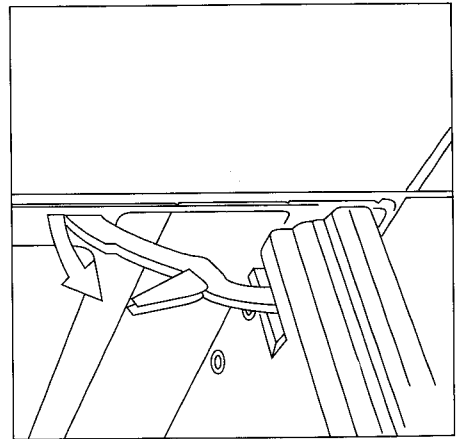

Figure 5

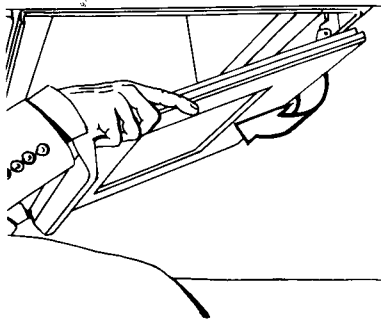

Figure 6

Stubborn stains on the inside of the doors can be removed by using a liquid cleaner, eg *Jif*. During cleaning the doors must not be immersed in water. Do not use scouring pads or abrasive powder which will scratch the glass. Cleaners which contain bleach should also not be used as they may dull the surface. After cleaning, wipe down with a damp cloth and dry with a soft cloth.

**WARNING: DO NOT RUN THE OVENS WITHOUT THE DOORS FITTED.**





### Cleaning the inside

'Stay Clean' side, roof liners and back panel (top oven only) can be purchased as an optional extra. These liners can be obtained either through your local Hotpoint Service Centre or your retailer (Part No. 6002 and 6006).

'Stay Clean' liners are covered with a special enamel which absorbs cooking soils. At higher temperatures the soiling is slowly destroyed. In most cases normal cooking at higher temperatures will permit this cleaning to take place automatically.

## The Cooking Systems in your Double Oven

Your new Double Oven is equipped with four different cooking systems:

1. **Conventional Cooking**  (**Lower and Top Oven**) – with upper and lower heat. This system is particularly suitable for roasting and baking on one shelf only.
2. **Variable Grilling**  (**Top and Lower Oven**) – the oven can also be used for conventional grilling with a fully controllable grill.  
**NOTE: The Oven Door should be closed when grilling.**
3. **Fan Cooking**  (**Lower Oven**) – the fan oven operates by constantly blowing heated air, from an element wrapped around the fan, into the oven. This gives improved efficiency and, in general, enables the use of lower temperatures for cooking. It also means that there is less need to be particular about shelf positions and that you can bake at more than one level simultaneously (Batch Baking).
4. **Fan Grilling**  (**Lower Oven**) – this is a combination of heat from the grill element and hot air circulated by the fan. Joints of meat and poultry will be browned as if they were cooked on a rotisserie or spit but more economically as the door is left closed.

These four systems of cooking are described more fully in the separate Recipe Book and we would suggest you read right through the Introductory Section of that book **before** using the oven.

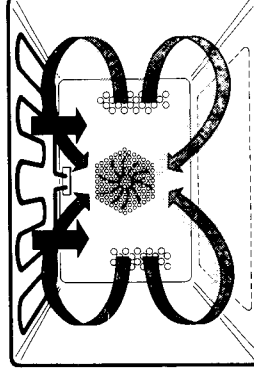
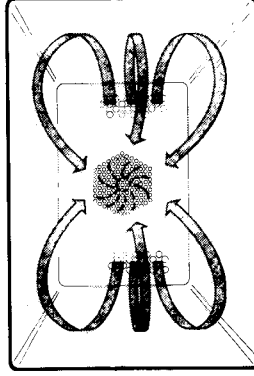
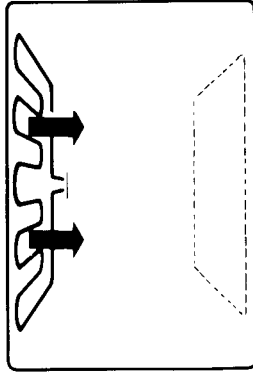
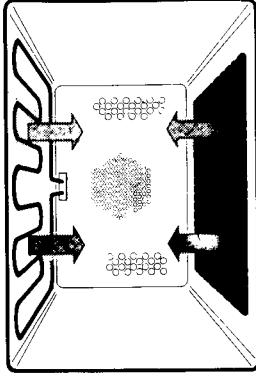

# The Controls

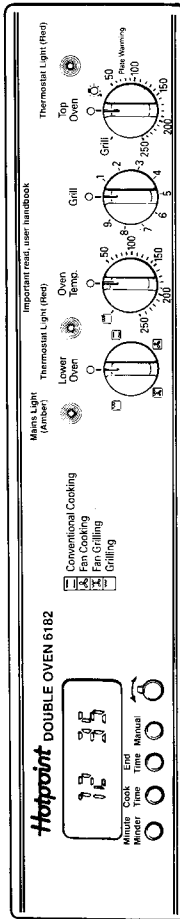

## Lower Oven Controls

Mains Light (Amber)



Thermostat Light (Red)



Lower Oven



Oven Temp.



Grilling



Fan Grilling



Before using the Lower Oven the Lower Oven Selector [L] must be turned to the appropriate position. The control has four settings.

 Conventional Cooking

 Fan Cooking

Now turn the Oven Temp Selector [T] clockwise to the required temperature. The Lower Oven thermostat light will immediately come on when either Conventional [C] or Fan Cooking [F] is selected and will remain on until the oven reaches the required temperature. The light will then automatically go off and on during cooking as the oven thermostat maintains this temperature. If the thermostat light does not come on when the thermostat is turned on, make sure that the Manual button is pressed so that the arrow above this button is not showing. When Fan Grilling [FG] or Grilling [G] is selected the



## Defrosting

**Without heat** – for frozen foods such as cakes, fruit, etc the Oven Temp Selector should be set at 'O' (Off) and shelf position 2 used.

**With heat** – for chicken portions, sausages, meat rolls, etc turn the Oven Temp Selector to 50-75°C and again use shelf position 2. This method of defrosting is only recommended for food up to 2 kg in weight and the food should be cooked immediately afterwards.

## Fan Grilling

Turn the Lower Oven Selector to [FG] and the Oven Temp Selector to the required temperature. The heat for Fan Grilling is provided by the grill element at the top of the oven and this heat is circulated around the food by the fan. The element and the fan are switched off and on alternately. It is ideal for roasting a joint or a chicken and has the same result as if you were cooking on a rotisserie but more economically as the door is left closed. There is no need to pre-heat the oven. Insert the grill pan and anti-splash tray on the floor of the oven or at shelf position 1. Place the food on one of the oven shelves and insert it at shelf position 1, 2 or 3, depending on the height of the food. For large pieces of meat or several

pieces a lower temperature and a longer grilling time will be necessary.



For ordinary grilling we would normally recommend using the Top Oven Grill with the Grill Selector (see page 12). However, if necessary the top element in the Lower Oven can be used as a full power grill by turning the Lower Oven Selector to [L] and the Oven Temp Selector to [T] but the oven door must be CLOSED. Alternatively it can be used at a lower setting by turning the Oven Selector to [L] and the Oven Temp Selector to a lower temperature. Care however should be taken with delicate foods, eg fish – as the grill will come on full initially in order to raise the temperature.

## Condensation

Under certain conditions condensation may become evident on the inner door and water may drip through the vent. This is normal when heat and moisture are present and may be a result of any of the following:

1. Kitchen temperature and ventilation.
  2. The moisture content of the food eg meat, roast/jacket potatoes, Yorkshire pudding, roasting meat etc.
  3. The quantity of food being cooked at any one time.
- It is normal for a built-in/built-under cooker to vent from a front aperture either situated in the handle or between the oven door and the fascia.





more than one shelf then the Fan Cooking System is recommended.

### Roasting

If roasting in an open dish, shelf position 2 is recommended. If roasting directly in the meat pan, use the anti-splash tray supplied so that during the cooking all the fat drains into the cavity base. This ensures that oven cleaning is kept to a minimum. If roasting or cooking a casserole in a closed dish it should be placed on a shelf either at position 1 or 2 depending on the size of the dish.





### Fan Cooking

Turn the Lower Oven Selector to  and the Oven Temp Selector to the required temperature. The heat for Fan Cooking is provided by an element situated at the back of the oven and around the fan. Therefore with this cooking system it is possible to utilise the floor of the oven, either by standing baking tins directly on the floor of the oven or by placing an inverted shelf () on the floor. This allows for greater flexibility within the oven.

### Baking

The advantage of this method of cooking is that as the oven heats up more quickly and generally foods cook at a lower temperature than in a conventional oven, pre-heating the oven is only required for certain types of food, eg Yorkshire pudding, bread, or if the cooking time is less than 25 minutes. Since the distribution of heat is more even most foods will cook satisfactorily in any shelf position, but the shelves should be evenly spaced. If only one shelf is being used then position 1 is preferable. Temperatures selected should be 10-30°C lower than with conventional heating – see separate cookery book.



When cooking a complete meal – for instance roast beef, roast potatoes, Yorkshire pudding and apple pie – place meat/potatoes upon anti-splash tray in meat pan on an inverted shelf () situated on the floor of the oven, with the apple pie and Yorkshire pudding on an inverted shelf () at position 3.

When batch baking large quantities of food for home freezing or parties, use shelf positions 1, 3 and 4.

Remember to place the food to be cooked in the centre of each shelf to allow for even air circulation around the food. It may be necessary to increase the cooking times by a few minutes to allow for the larger mass of food, and to take out food on the upper shelf slightly earlier. If you are batch baking you will need to pre-heat the oven.

Detailed charts covering temperatures and shelf positions for Fan Cooking are given in the recipe book supplied.

thermostat light will not operate. After use always set the Lower Oven Selector and the Oven Temperature Selector back to 'O' (Off).

If required the top element in the Lower Oven can be used as a Grill by setting the Lower Oven Selector to  and the Oven Temp Selector either to  or a lower setting on the Selector if less than full power is required. Always remember to keep the oven door closed.

### Top Oven Controls

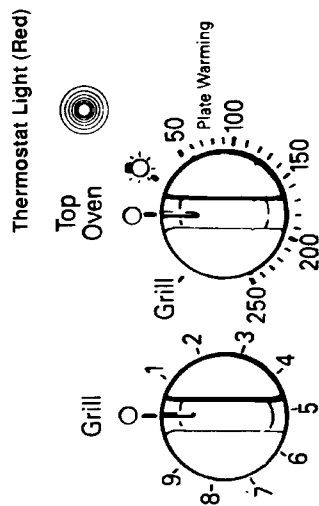

To heat this oven, turn the Top Oven Selector clockwise to the required temperature. The Top Thermostat Light will immediately come on and remain on until the oven reaches the selected temperature. The light will then automatically go off and on during cooking as the oven thermostat maintains this temperature. After use always turn the Oven Selector anti-clockwise back to 'O' (Off).

To use the grill set the Top Oven Selector to GRILL and the Grill Selector to a number within the 1-9 range.

## The Automatic Oven Timer

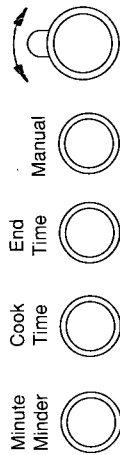
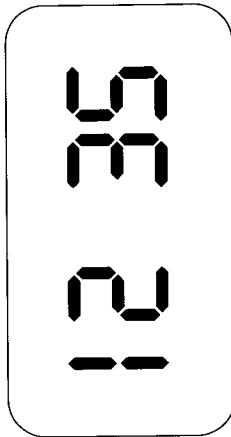

Both the Lower and Top Ovens, with the exception of the Grills, can be controlled by the Automatic Timer.

The Timer is controlled by the Electronic Clock. Check that the clock is showing the correct time, if not reset it by pressing in both the Cook Time and End Time Buttons and hold them in while turning the Time Control knob ↻ until the correct time appears on the Clock and Auto is illuminated showing that the Oven is in the automatic mode. To select Manual press the Manual Button and Auto disappears.

### The Minute Minder

The Minute Minder can be used independently or in conjunction with the Automatic Timer and will give an audible reminder. It does not control the operation of the ovens.

Press the Minute Minder Button and will appear in the Display.

Holding the button in, turn the Time Control knob ↻ to the length of time required. Release the button and the Clock will revert back to the time of day but with a illuminated

10

between the centre figures. The Minute Minder Button can be pressed at any time to show how long it will be before it sounds. At the end of the set time the Minute Minder will sound but can be switched off by pressing any one of the buttons.

### To set the Timer to switch ON and OFF automatically

1. Press and hold in the End Time Button and turn the Time Control knob ↻ until the time you want the meal to finish cooking appears on the Clock. Release the button and the clock will revert back to the time of day with Auto visible to show the oven is in the Automatic Cooking Mode.
2. Press and hold in the Cook Time Button, and turn the Time Control knob until the length of time you want the meal to cook for is shown on the Clock (this sets the switching-on time). Release the button and the clock will revert back to the time of day.
3. Turn the appropriate Oven Control (or controls if using both ovens) to the required temperature and if using the Lower Oven the Lower Oven Selector to the type of heating required.

## Cooking in the Lower Oven

To obtain the best results it is recommended that you use the wire shelves and meat pan provided individually or if cooking on more than one shelf, in conjunction with your own baking tins.

Only put in the shelves or fittings you actually want to use. Unused shelves only restrict access and get in the way. If possible it is a good idea to remove the fittings when you have finished cooking so that when you next come to use the oven you do not inadvertently heat up unnecessary shelves or tins – as well as being more convenient this will even save electricity.

### Position of shelves

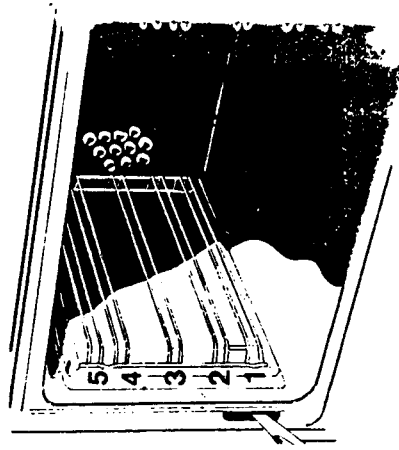

### Conventional Cooking

Turn the Lower Oven Selector to and the Oven Temp Selector to the required temperature.

### Baking

Always place the item you are baking in the centre of the shelf. You will find that shelf position 1 or 2 will give the best results. If you are baking on

15

If using aluminium foil **never** allow the foil to touch the sides of either of the ovens. **Never** cover the interior or shelves with foil.

**Baking**  
Always place the item you are baking in the centre of the shelf and locate the shelf at shelf position 1. If using the flat baking tray supplied always have the sloping edge towards the front.

### Roasting

When roasting shelf position 1 is recommended. If roasting directly in the meat pan use the anti-splash tray so that, during cooking, all the fat drains into the cavity base, this ensures that oven cleaning is kept to a minimum.

Detailed charts covering

temperatures and shelf positions for Conventional Cooking are given in the recipe book supplied.

## Cooking in the Top Oven

The Top Oven can be used for normal cooking, but on a smaller scale. Where necessary it is advisable to stand dishes on a baking tray to avoid spillage on to the floor of the compartment. Most foods will cook at a slightly lower temperature in the smaller Top Oven than in the larger Lower Oven.

### Position of Shelves

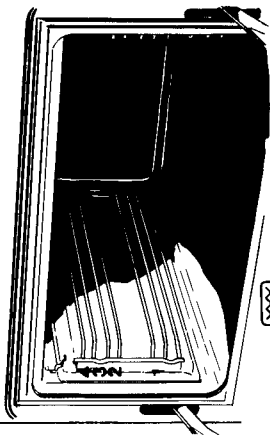

### Grilling

The grilling facility in the Top Oven enables you to use the full width of the grill.

To use the full width of the grill turn the Top Oven Thermostat to 'Grilling'. The grill power can be adjusted by means of the Grill Selector (settings 0-9).

Grilling should be done with the Top Oven door CLOSED. There is no need to pre-heat. Use the grill pan with the anti-splash tray and the reversible grill pan, if necessary, in positions 2-4, according to the thickness of the food. If you find excessive smoke being emitted then turn the Grill Selector to a lower setting and/or move the grill pan to a lower position.

**WARNING. THE GRILL PAN MUST BE CLEANED AFTER EVERY USE. EXCESS FAT BUILD UP IN THE BOTTOM OF THE PAN COULD CAUSE A FIRE HAZARD.**

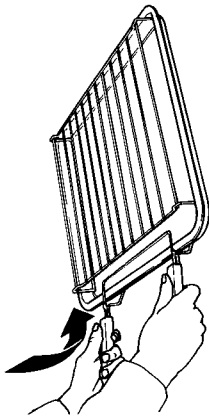

Fix the grill pan handle securely in position. With the grill pan handle in the vertical position, place the chrome section centrally over the grill pan lip. Drop the handle away from the grill pan and ensure that the handle is secure before use (see illustration).

### Conventional Cooking

Turn the Top Oven Selector to the required temperature. The heat for Conventional Cooking is provided by the Grill element and the element under the floor of the oven. Therefore **DO NOT COOK DIRECTLY ON THE FLOOR OF THE OVEN**, or place food too close to the top element.

### Warming Dishes

The Top Oven is ideal for warming dishes and keeping food hot. Dishes should not be placed directly on the floor of the oven and the Top Oven Selector should be turned to 'Plate Warming'.

**WARNING: DO NOT PUT DELICATE CHINA OR ITEMS WHICH COULD BE AFFECTED BY HEAT INTO THE OVEN.**

4. The Oven(s) will automatically switch ON (the middle indicator arrow will disappear) when the pre-selected start time has been reached and switch OFF when the End Time is reached. At that time the arrow above the Cook Time Button will disappear and the Minute Minder will start to sound to remind you that the meal is ready to take out. The Minute Minder will sound for approximately 2 minutes but can be switched off beforehand by pressing any one of the buttons. The arrow above the Manual Button will start to flash.
5. After use turn the appropriate controls to 'O' (Off) and press the Manual button to return the oven(s) to Manual operation (the arrow above the Manual Button will disappear).

### To set the Timer to switch OFF only

The timer may be used to switch the Oven(s) off.

1. Follow step 1 as above.
2. Turn the appropriate Oven Control (or controls if using both ovens) to the required temperature and if using the Lower Oven the Lower Oven Selector to the type of heating required. The Oven thermostat light(s) will come on and the oven(s) start to heat up.
3. The oven(s) will automatically switch OFF when the End Time is reached. At that time the arrow above the End Time Button will disappear and the Minute Minder will start to sound to remind you that the meal is ready to take out.

The Minute Minder will sound for approximately 2 minutes but can be switched off beforehand by pressing any one of the buttons. The arrow above the Manual Button will start to flash.

4. After use turn the appropriate controls to 'O' (Off) and press the Manual Button to return the oven(s) to Manual operation (the arrow above the Manual button will disappear).

### General notes on using the Automatic Timer

1. When setting any part of the timer, always keep the appropriate button pressed in with one hand and turn the Time Control at the same time with the other hand.
2. After a button has been released an arrow will remain above it on the Clock to act as a reminder of what has been selected.
3. If the arrow above the Manual Button flashes this means that the Oven is in the Automatic mode. Press the Manual Button to change the oven to Manual operation (the arrow disappears).
4. If you wish to cancel or change one of the settings simply press the appropriate button and turn the Time Control back to 00.00. Reset the appropriate button as required.
5. If after setting the timer or when the meal has started to cook you want to know how long it will take simply press the Cook Time Button and the length of time will be shown on the Clock.
6. If you want to know when the cooking will come to an end simply press the End Time Button

## Before using your Double Oven for the first time

In some models the shelf racks will have to be inserted. To do this first push the long ends of the racks into the top openings in the side walls and then insert the bottom ends in the holes provided.

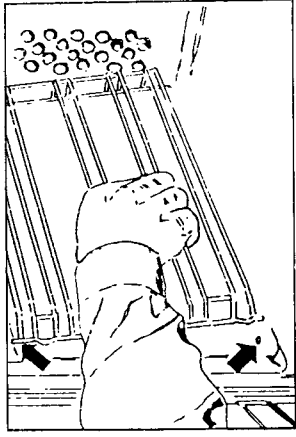

### Make sure the electricity supply is switched ON

Your Double Oven is fitted with an Electronic Clock and Timer. When switching the oven on for the first time or if the power supply has been interrupted the Electronic Clock will flash 0:00. To set the clock to the time of day press both the Cook Time and End Time Buttons and hold them in while turning the Time Control knob until the time of day appears on the Clock. When you have reached the right time release the buttons and the clock will operate. Remember that the clock is a 24-hour one so that 3 o'clock in the afternoon will show on the Clock as 15:00.

- and the finishing time will be shown on the Clock.
- The Minute Minder can be set to come on before the end of automatic cooking, eg. to remind you to put the vegetables on. The Minute Minder will sound a second time at the end of the automatic cooking period.
  - Always remember to press the Manual Button after you have used the Automatic Timer to return the Oven to Manual operation.

**WARNING: CHILDREN SHOULD NOT BE ALLOWED TO PLAY WITH THE CONTROLS OR TAMPER WITH THE APPLIANCE.**

### Manual/Automatic

For normal operation (without automatic timing) the Manual Button must be pressed so that the arrow above the button disappears – this ensures that the oven is in the Manual mode.

To remove the 'new smell', heat up the empty ovens for 30 minutes keeping the doors closed. To heat up the Lower Oven turn the Lower Oven Selector to  – the Mains ON/OFF light and the light inside the oven will come on – and set the Oven Temp Selector to 250. When you do this the Lower Oven Thermostat light on the Control Panel will come on. To heat up the Top Oven turn the Top Oven Selector to 250 – the Top Oven Thermostat Light and the light inside the Top Oven will come on.

The new smell is due to any temporary finish on oven fittings and elements and also any moisture absorbed by the lagging. The odour will cease after a short period of use. Ensure that the area is well ventilated and that persons and pets, who are possibly sensitive to the odour, are removed from the vicinity.

## Free Manuals Download Website

<http://myh66.com>

<http://usermanuals.us>

<http://www.somanuals.com>

<http://www.4manuals.cc>

<http://www.manual-lib.com>

<http://www.404manual.com>

<http://www.luxmanual.com>

<http://aubethermostatmanual.com>

Golf course search by state

<http://golfingnear.com>

Email search by domain

<http://emailbydomain.com>

Auto manuals search

<http://auto.somanuals.com>

TV manuals search

<http://tv.somanuals.com>