

# Hotpoint Service and Spares

FOR SERVICE: If you have a problem with your appliance ring your local Service Office.

FOR SPARES and ACCESSORIES: To purchase spares and accessories send your Accessories Order Form to your Spares Centre. If the accessory or spare part you want is not on the form, contact your Spares Centre for prices and availability.

Please address all correspondence to Hotpoint Spares Centre or Hotpoint Service Office as applicable.

Service Offices are open between 8.00am-8.00pm Monday to Friday.  
8.30am-6.00pm on Saturdays and 10.00am-4.00pm Sundays.

Spares Centres are open between 8.00am-5.00pm Monday-Friday and 8.00am-12.30pm on Saturdays.

**EAST**  
● **ESSEX:** Industrial Buildings, Beehive Lane, Chelmsford, CM2 9TE.  
Post Codes RM & IG Tel: (01245) 492433  
Remainder of Essex Tel: (01245) 269331

● **PETERBOROUGH:** Cella Road, PE2 9JB. Tel: (01733) 64741  
For Spares Spares Administration Dept. Tel: (01733) 556520

● **LONDON**  
● **HARROW:** Unit 10, Crystal Way, Harrow, Middlesex, HA1 2HP.  
Tel: 0181-863 3636  
Tel: 0181-863 4113

**MIDLANDS**  
● **BIRMINGHAM:** Westgate, Aldridge, W Midlands, WS9 8UX.  
Post Codes B Tel: (01922) 743374  
All other Post Codes Tel: (01922) 743376

● **NOTTINGHAM:** For Spares Tel: 0115-986 0387  
Ashing Street, NG2 3UB  
Tel: (0115-986 2431/4322

● **NORTH EAST**  
● **WETHERBY:** Sandbeck Lane, LS22 4TW For Spares Tel: (01937) 581221  
Tel: (01937) 581261/581444

● **NORTH WEST**  
● **MANCHESTER:** 44/46 Station Road, Heaton Mersey, Stockport, SK4 30T.  
For Service All LA Post Codes  
Manchester North Tel: 0161-432 0513  
Manchester South Tel: 0161-442 8677  
Tel: 0161-432 0255

● **SCOTLAND**  
● **RENFREW:** West Lodge Road, Blythswood Estate, PA4 9EN.  
All CA Post Codes  
Tel: 0141-886 6241 For Spares Tel: 0141-886 5611

● **SOUTH**  
● **KENT, SUSSEX AND SURREY:** Larkfield Trading Est, New Hythe Lane, Larkfield, ME20 6SW.  
Tel: (01622) 790707  
Tel: (01622) 716631  
For Service Unit R, S Flampositie Ind Park, Salisbury Rd, Totton, SO40 3SA.  
● **SOUTHAMPTON:** For Spares Tel: (01703) 867933  
Tel: (01703) 861981/867374

● **WALES**  
● **NORTH:** Westgate, Aldridge, West Midlands, WS9 8UX.  
Tel: (01922) 749374  
18 Western Ave, Bridgend Ind. Estate, Bridgend, CF31 3SL.  
● **SOUTH:** Post Codes CF, SA & SY23-25 Tel: (01656) 664721  
For Service Post Codes BS, GL (not 55), HR, SY15-18, LD1-8, NP. Tel: (01656) 655554  
Tel: (01656) 766111

In accordance with its policy of progressive product design, the Company reserves the right to alter specifications. Hotpoint Ltd, Peterborough, PE2 9JB, England

# FULL INSTRUCTIONS FOR INSTALLING AND OPERATING YOUR HOTPOINT DOUBLE OVEN MODEL 6183

- Service Office and Spares Centre
- Service Office only

<p><b>IRELAND</b> ● <b>NORTHERN:</b> 256 Ormeau Road, Belfast, BT7 2FL. Tel: (01232) 647111 49 Airways Ind. Estate, Dublin 17. Tel: Dublin 426088 Tel: Dublin 426836</p> <p>■ <b>EIRE:</b> For Service For Spares</p>	<p><b>CHANNEL ISLANDS</b> – Service provided by Agents. Normal Guarantees apply and all Service Schemes are available.</p> <p>● <b>JERSEY:</b> 19 Don Street, St. Helier. Tel: (01534) 21625 Cloë D’Ormes, Pontac, St Clements. Tel: (01534) 54808</p> <p>or</p> <p>● <b>GUERNSEY &amp; SARK:</b> Valois Stores, Grande Rue, St Martins, Guernsey. Tel: (01481) 38422 Barras Lane, Vale Tel: (01481) 51610 32 High Street Tel: (01461) 822886</p>
<p><b>ISLE OF MAN</b> – Service provided by Agents. Normal Guarantees apply and all Service Schemes are available</p> <p>from 5 Drummond St., Douglas. Tel: (01624) 673233</p> <p>or</p> <p>Troncade Works, Cronkbourne Village, Douglas, Tel: (01624) 678066</p> <p>or</p> <p>17 Ridgeway Street, Douglas, Tel: (01624) 25811/25848</p>	<p><b>SHETLAND, ORKNEY &amp; WESTERN ISLES</b> – Service provided by Agents. Normal Guarantees apply, but Service Schemes are NOT available.</p> <p>● <b>SHETLAND:</b> Fort Road, Lerwick Tel: (01595) 2557 Falsstone Ind. Estate, Kirkwall. Tel: (01856) 5457</p> <p>● <b>ORKNEYS:</b> 27 Bayhead Street, Stornoway, Isle of Lewis Tel: (01851) 3387</p> <p>● <b>WESTERN ISLES:</b> Local Hydro Electric Shops. Which are covered by Hotpoint.</p> <p>● <b>OTHER ISLANDS, EXCEPT ARRAN, BUTE &amp; SKYE</b> –</p>

# Hotpoint®

## Before you operate your new Hotpoint Double Oven

This appliance conforms to the following EEC Directives:

Low Voltage Equipment  
73/23/EEC  
93/68/EEC

Electromagnetic Compatibility  
89/336/EEC  
92/31/EEC  
93/68/EEC



Please read these instructions fully.

### ENSURE THAT THE COOKER IS INSTALLED BY A QUALIFIED ELECTRICIAN FOLLOWING THE INSTRUCTIONS BELOW.

1. Your oven should **not** be located adjacent to a gas hob heater or eye level grill as flames from the burners could cause damage to your oven.
2. For your own safety and to get the best results from your oven it is important to read through this Handbook **before** using your oven for the first time including the Always and Never on pages 8 and 9.

### Electrical Requirements

- Any electrical wiring must be carried out in compliance with the appropriate IEE and Electricity Company regulations by a qualified electrician, eg. your local electricity board or a contractor who is on the roll of the National Inspection Council for Electrical Installation Contracting (NICEIC).

### WARNINGS – INCORRECT INSTALLATION COULD AFFECT THE SAFETY OF THE OVEN.

- THIS APPLIANCE MUST BE EARTHED.
- BEFORE CONNECTING OR INSTALLING THE OVEN THE ELECTRICITY SUPPLY MUST BE SWITCHED OFF.

- **THE INSTALLER MUST** check that the voltage shown on the rating plate corresponds with the house electricity supply.
- The oven must be supplied via a suitable double pole isolating switch, having a contact separation of at least 3 mm in all poles placed in a readily accessible position adjacent to the unit.
- The maximum loading for your oven is 5.5kW.
- If the oven is to be wired into a connector unit this may be positioned behind the oven provided the following requirements are met:
  - i) The connector unit must not project from the wall more than 25 mm.
  - ii) The top of the connector must not be more than 350 mm above the base of the oven recess.
- After unpacking the oven stand it on the packing base in order to avoid damage.
- **Electrical Connections**
  - Remove the terminal cover at the rear base of the oven. Pass the cable through the cable clamp and connect to the appropriate terminals provided. Allow sufficient cable so that the oven can be set down on the floor whilst still connected up. Tighten the screws on the cable clamp and replace the terminal cover. Make mains connections.
  - This appliance conforms to EN55014 regarding suppression of Radio and Television reception interference.
  - Where a double oven is used a 20 amp double pole control switch should be used to feed the unit using a suitable rated cable. We recommend that a minimum of 4mm<sup>2</sup> PVC insulated twin and earth cable conforming to B.S. 6004.
  - Where a hob is fitted adjacent to an oven then a 45 amp Double Pole control switch should be used to feed both units via separate suitably rated cables. We recommend that a minimum of 4mm<sup>2</sup> PVC insulated twin and earth cable conforming to B.S. 6004.

**WARNING: CHILDREN SHOULD NOT BE ALLOWED TO PLAY WITH THE APPLIANCE OR TAMPER WITH THE CONTROLS.**

**PLEASE READ THIS BOOKLET CAREFULLY.**

## **Contents**

	Page
Before you operate your new Hotpoint Double Oven	2
Electrical Requirements	2
Installation Instructions	4-7
For Your Safety - Always	8
Never	9
The main parts of your Double Oven	10
The cooking systems in your Double Oven	11
Before using your Oven for the first time	12
Temperature Conversion Scale	12
Controls	13-14
The Automatic Oven Timer	15-17
Grilling in the Top Oven	18-19
Cooking in the Top Oven - Conventional Cooking	20
Cooking Temperature Charts	21-22
Grilling in the Lower Oven	23
Grilling in the Lower Oven - Temperature Chart	24
Cooking in the Lower Oven - Fan Grilling	24
Lower Oven Temperature Charts - Fan Grilling	25
Cooking in the Lower Oven - Fan Cooking	26
Fan Only	27
Care and Cleaning	28-30
If Something Goes Wrong	31
If It Still Won't Work	31
Hotpoint Service Cover	32
Hotpoint Service and Spares	Back Cover

## **Retention of this Instruction Book**

This Instruction Book must be kept handy for reference as it contains important details on the safe and proper use of the appliance. If you sell or pass the appliance to someone else, or move house and leave it behind, make sure this Book is also provided so the new owner can become familiar with the appliance and safety warnings. If the Book is lost or damaged a copy may be obtained from Hotpoint Ltd, Celta Road, Peterborough, PE2 9JB.

# Installation Instructions

Ensure that the electricity supply is turned off before installing your appliance.

## **IMPORTANT DO NOT LIFT OVEN BY THE DOOR HANDLES.**

This equipment is designed specifically for domestic purposes and Hotpoint Limited cannot accept responsibility if used for any other type of application.

**All electrical installations must be carried out by a NICEIC registered installer.**

**WARNING: THIS APPLIANCE  
MUST BE EARTHED.**

### 1. General

The appliance is designed for mounting at a safe level into an open housing which must be secured to the backing wall.

### 2. Oven Unit Housing Cabinets

- a. The oven unit housing cabinet dimensions must comply with Fig. 4. (See pages 6 and 7.)
- b. An air gap of 50 mm minimum must be provided at the rear of any top or bottom cupboards or shelves. (See Fig. 1 page 6.)
- c. Ventilation must be unobstructed, ie. from adjacent cabinetry. This can be done by either raising the base of the cabinets using the adjusting feet (or spacers) or alternatively by providing a slot in the cabinet plinth to the dimensions shown overleaf.
- d. The air gap at the rear allows the warmed air to pass out of the inner cabinet space, but where it is intended to fit

cupboards above the oven unit to ceiling height it is essential that the warmed air is exhausted through the front of the cabinet Fig. 1. (See page 6.)

- e. If an oven unit is installed adjacent to a tall cabinet, steam escaping from the oven when the door is opened could condense on, and perhaps stain, the adjacent surface. To prevent permanent staining, the adjacent surface should be made of a material that is heat resistant and easy to clean. Adjacent tall cabinets should not be deeper than the oven housing cabinet.

### **IMPORTANT**

It is essential that the lower cupboard is constructed in the manner illustrated see pages 6 and 7 ie. having side, back and roof panels so joined as to provide no apertures which could permit access to the oven unit when installed .

### 3. Final Installation

- a. Using a spirit level, check that the housing cabinet is level from side to side and from front to back in its installed position .
- b. Correct any unevenness by placing wooden packing under the bottom of the cabinet. Make sure that the cabinet rests firmly on the cabinet floor without rocking
- c. Before the oven is fitted, the cabinet must be firmly secured to the backing wall for stability.



## Hotpoint Service Cover

### Satisfaction Guaranteed or Your Money Back

Hotpoint gives you a unique 'Satisfaction Guaranteed' promise - valid for ninety days after you have purchased your Hotpoint product. If there is a problem with your Hotpoint appliance just call your Hotpoint Service Office. If necessary we will arrange for an engineer to call. If the problem is not resolved by us under this Guarantee, Hotpoint will replace your appliance, or, if you prefer, give you your money back. This Guarantee is additional and subject to the terms of Hotpoint's Five Year Parts Guarantee.

### Hotpoint's Free Five Year Guarantee

- From the moment your appliance is delivered Hotpoint guarantees it for **FIVE YEARS**.
- In the Five Years all replacement parts are **FREE** provided they are fitted by our own Service Engineer. During the first year our Engineers time and labour is also free.
- After the first year we will charge for our Engineers time and labour. We do, however operate a range of Service Plans (see opposite) which for an annual payment enables you to cover any repair costs which may be necessary.
- All of our service repairs are guaranteed for twelve months in respect of our labour and any parts fitted.
- The appliance must be used in the United Kingdom and must not be tampered with or taken apart by anyone other than our own Service Engineer.
- You may, however, buy parts which can be safely fitted without specialist knowledge or equipment. The correct fitting of such parts, provided they are genuine Hotpoint spares, will not affect your Guarantee. Parts are available from our main Hotpoint Spares Centres.
- Our Guarantee does not cover the cost of any repair which is needed because of power cuts, accidents or misuse. Nor does it cover the cost of any visit to advise you on the use of the appliance. Please read the instruction book thoroughly.
- If at any time during the Guarantee period we are unable to repair your appliance, we will refund any repair costs paid to us in the previous twelve months. We will also offer you a new appliance at a reduced charge instead of a repair.
- Our Guarantee is in addition to and does not affect your legal rights.
- Should you need independent advice on your consumer rights, help is available from your Consumer Advice Centre, Law Centre, Trading Standards Department and Citizens Advice Bureau.
- All Hotpoint servicing is done by our own Service Organisation located throughout the United Kingdom and Southern Ireland. It will be happy to deal with any problems.

32

## Installation Instructions

- Affix the correct number of self adhesive spacer pads to the outside of the side trims over the fixing holes to make up to the actual cabinet aperture (see Fig. 3 page 7).
- The oven unit should now be lifted (by 2 adults) into the cabinet and pushed fully home. (Care should be taken not to dislodge the spacer pads.)
- Finally the oven unit must be secured to the cabinet by means of the four countersunk screws, two through each side trim.
- REMOVE ALL PACKING MATERIAL FROM THE GRILL AND OVEN INTERIOR.**

### List of Loose Items

- 4 Countersunk Pozi Head No. 6 x 15mm screws.
- 4 3 mm thick self adhesive spacers.
- 12 0.75mm thick self adhesive spacers.

### Hotpoint's Service Care

Whether you have just one or a number of Hotpoint appliances in your kitchen, Hotpoint has a range of Service Schemes to give you complete peace of mind.

### Service Cover

A single payment covers you for all repairs during the period of cover, which can be from 1 to 4 years. There is also an option of Service Cover with Maintenance at an additional cost. This includes an annual Electrical and Safety check and replacement of any parts as necessary. For 1 year contracts this takes place towards the end of the contract period.

### Kitchen Cover

An annual payment covers you for all repairs for all your Hotpoint appliances which are less than 10 years old. It also covers the cost of loss of food up to £250 in our refrigeration and freezer products. There is also the option of Kitchen Cover with Maintenance at an additional cost. Any additional Hotpoint appliances purchased after you have joined Hotpoint Kitchen Cover will automatically be included during the annual period of cover without further charge.

### Appliance Registration

To ensure that you have the opportunity to benefit from any of the above Service Schemes you should complete and return immediately the Appliance Registration Form supplied with your appliance. Full details and costs of our Service Schemes together with an application form will be sent to you at the end of the first year of the guarantee.

### Annual Safety/Maintenance Checks

Hotpoint strongly recommends that all its appliances are regularly checked for electrical and mechanical safety whether or not they are covered by a Service Plan.

### Proof Of Purchase

For future reference please attach your purchase receipt to this booklet and keep it in a safe place.

### Spares and Accessories

Spares and accessories can be ordered from your local Hotpoint Spares Centre (listed on the back page), using the order form enclosed.

**NOTE:** Our Engineer will use every effort to avoid damage to floor coverings and adjacent units when carrying out repairs/service work but in locations where the Engineer advises you that it will be impossible to move the appliance without risk of damage, he will only proceed with your approval that no liability is accepted.

## Installation Instructions (cont'd)

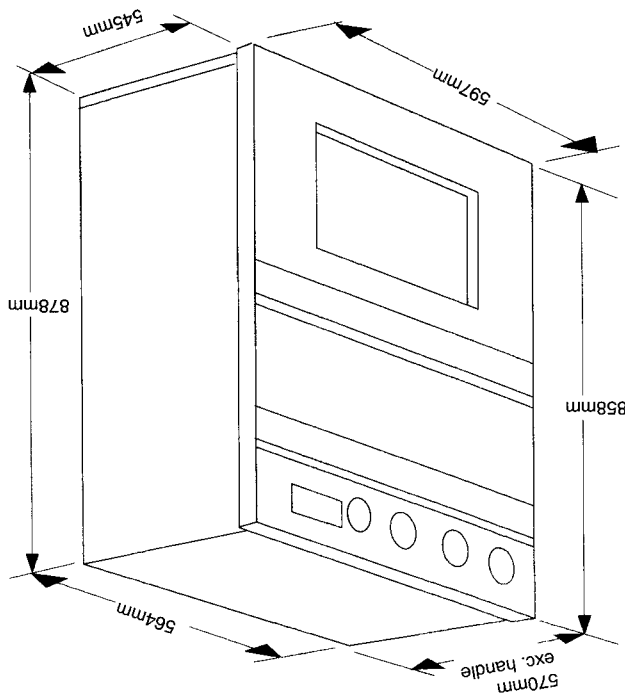

Fig. 2

## If something goes wrong...

First, don't panic! There may be nothing wrong at all. Check the points below before calling your Hotpoint Service Office.

1. Check that the mains supply is switched on.
2. Check that the Timer Control has been set to Manual operation and not left on automatic (see pages 15 to 17).
3. A fan can be heard as soon as the Oven Temperature Control is switched on. This is quite normal when the oven is in operation.

## If it still won't work...

### Contact the Service Office

If there is still a problem with your oven after checking the points above:

1. Switch off the oven at the oven control panel.
2. Call your nearest Hotpoint Service Office or local importer (outside the UK). The telephone number is shown on the back page. Note the number down in the space below:

.....  
When you contact us we will want to know the following:

1. Your name, address and post code .
2. Your telephone number.
3. Clear and concise details of the fault.
4. The model number (6183), the serial number (found on the rating plate on the inner oven

5. The date of purchase. Enter the date here:

6. ....  
if you have taken out one of the Hotpoint Service Schemes.

Please make sure you have these ready when you call.

## Spare Parts

Please remember your new appliance is a complex piece of equipment.

'DIY' repairs or unqualified and untrained service people may put you in danger, could damage the appliance and might mean you lose cover under Hotpoint's Parts Guarantee .

If you do experience a problem with the appliance don't take risks; call in Hotpoint's own Service Engineer. The address and telephone number of your nearest Hotpoint Service Office is in your local telephone directory or see back page of this book.

Our spare parts are designed exclusively to fit only Hotpoint appliances. Do not use them for any other purpose as you may create a safety hazard.

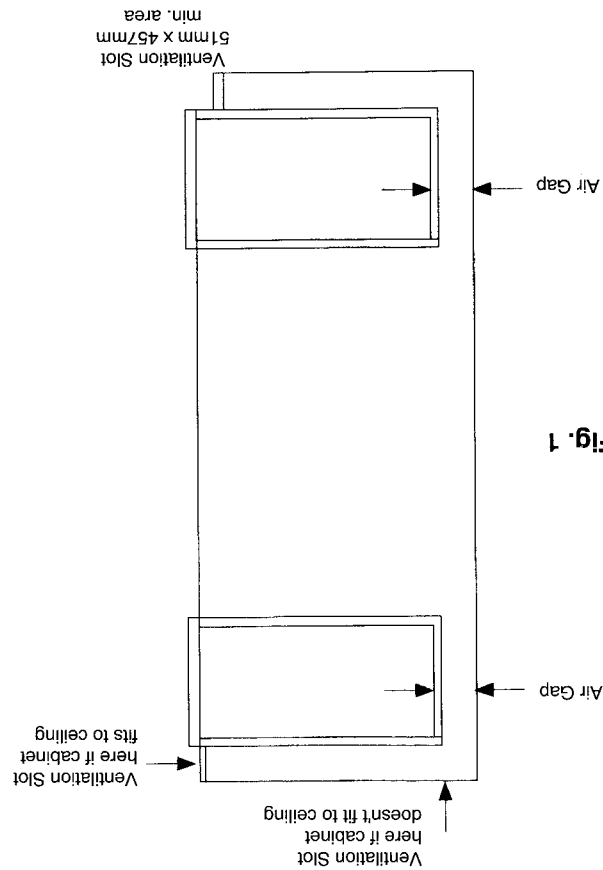

Fig. 1

# Care and Cleaning

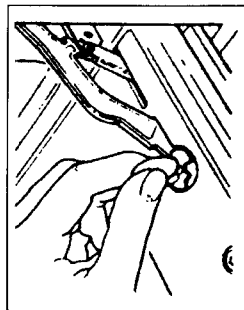

Fig. 8

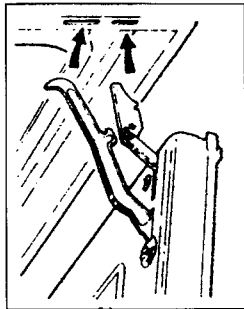

Fig. 9

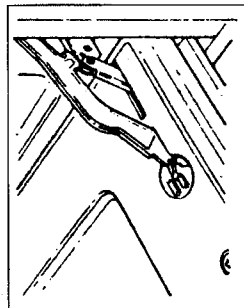

Fig. 10

## Main Oven

**Glass Door:** Remove door as on page 30 and unscrew the two screws securing the glass panel, taking care not to damage the seal. Carefully slide the middle door glass through the aperture at the top of the door (see Fig. 11). The glass panels may now be washed. Stubborn stains can be removed by using a fine steel wool soap pad. **Do not use scouring pads, or abrasive powder, which will scratch the glass.**

Take particular care not to damage the inner surface of the inner door glass which is coated with a heat reflective layer. After cleaning, rinse and dry with a soft cloth, always refit the glass and seal correctly. For slight soiling the inner glass panel may be cleaned, while warm, without removing it from the door.

When replacing the middle door glass, it will be necessary to push in the retaining clips to insert the glass fully.

**NEVER OPERATE THE OVEN WITHOUT THE INNER AND MIDDLE GLASS PANELS CORRECTLY REFITTED.**

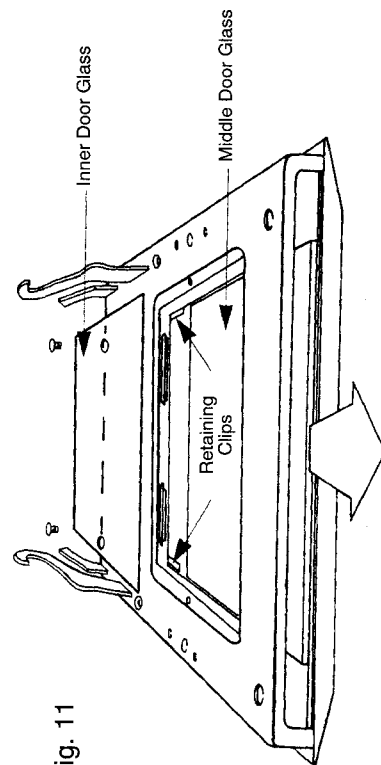

Fig. 11

Fig. 4

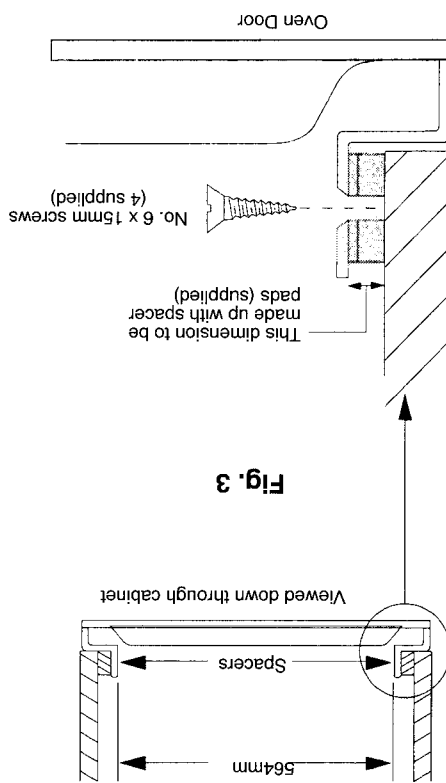
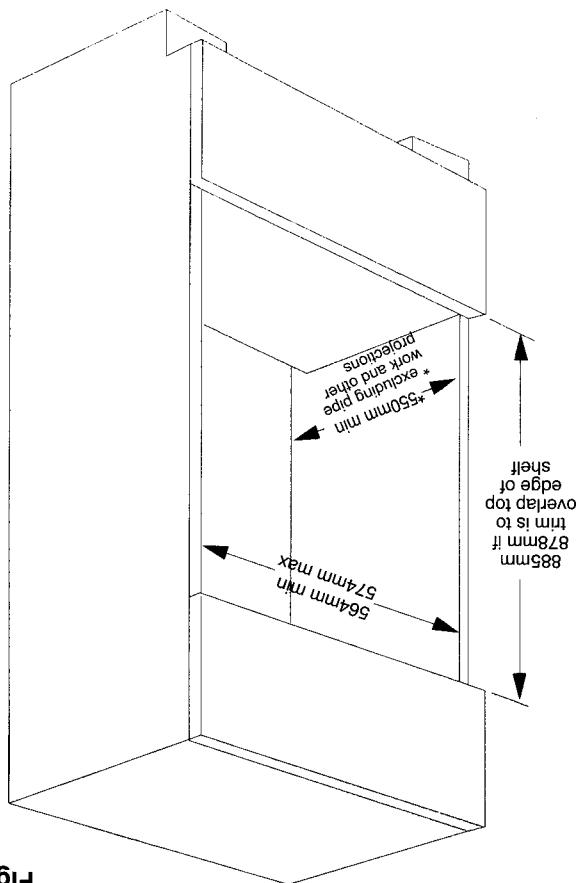

Fig. 3

## For Your Safety, Always ...

**Please read through before operating your appliance.**

- ALWAYS** Have your appliance installed by a competent engineer or electrical contractor.
- ALWAYS** Ensure the appliance has been properly earthed.
- ALWAYS** Remove all transportation packing from inside the oven/grill before switching on for the first time.
- ALWAYS** Make sure you understand the controls prior to using them. (See pages 10 and 11)
- ALWAYS** Keep children away from the oven at all times when oven/grilling as surfaces will get extremely hot.
- ALWAYS** Remember that the oven and utensils will be very hot when in use.
- ALWAYS** Take care when opening the door. Let the steam and hot air escape before removing the food.
- ALWAYS** Use dry quality oven gloves for removing hot food utensils from the oven/grill.
- ALWAYS** Select the correct shelf position before turning the oven or grill on.
- ALWAYS** Turn off the electricity supply at the wall switch before cleaning.
- ALWAYS** Ensure poultry is thoroughly defrosted before cooking well.

- ALWAYS** Check all controls on the appliance are switched off before retiring to bed or after use.
- ALWAYS** Keep ventilation slots clear of obstructions.
- ALWAYS** Reset the oven timer to Manual after completing an Automatic Cooking Programme.
- ALWAYS** Take care on warm days when using the oven for delayed automatic cooking as certain foods can spoil.
- ALWAYS** Use a thick cloth to protect your fingers when replacing the oven lamp.
- ALWAYS** Refer servicing to a qualified appliance service engineer.
- ALWAYS** Follow the guide lines for successful defrosting when using the fan only mode.

## Care and Cleaning

It should not normally be necessary to clean the Stay Clean panels with water. If the user feels it is desirable to do so, wash them down in warm, soapy water, followed by rinsing with clear water: **Do not use biological/enzyme washing powder, harsh abrasives or oven chemical cleaners of any kind.** Replacement oven liners are available should you require them, from your nearest Hotpoint Service Centre (see back page).

### Replacement of Oven Lamp

**WARNING: ISOLATE COOKER FROM SUPPLY BEFORE REPLACING LAMP.**

Open the oven door and remove the rod shelves. Grip the light glass dome, unscrew anti-clockwise and lift out. Reach into the aperture with fingers, and unscrew the faulty lamp anti-clockwise (25W 300°C SES) (Part No. 620601) which can be obtained from your nearest Hotpoint Service Centre. Fit replacement lamp, and refit dome. When screwing and unscrewing the faulty lamp use a thick cloth to protect your fingers should the lamp break.

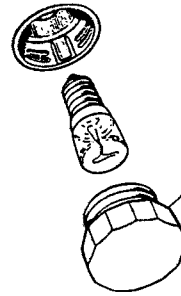

**WARNING: ISOLATE COOKER FROM SUPPLY BEFORE REMOVING DOOR.**

### Oven Door Removal Main (Lower) Oven

Caution: When removing the Lower Oven Door, **DO NOT** turn the door upside down: middle glass may fall out. The door is removable to facilitate occasional cleaning of heavy soiling from the oven floor and from the door itself.

**Please note** that the door is heavy and care should be taken not to pinch your fingers during the removal and replacement.

To remove, open the door fully and, using a coin or screwdriver, turn the two discs clockwise to the position shown below (Fig. 8). Slightly close the door, unhook the lower hinge fingers, then pull the door away from the oven front frame.

To replace, insert the lower fingers and the hooked ends of the door stays, ensuring that the slots in the lower fingers engage with the front frame (Fig. 9). Fully open the door and turn the discs anti-clockwise to their normal working positions (Fig. 10).

Close the door - the hinge will now lock into position.



## Care and Cleaning

### TURN OFF THE MAIN SWITCH BEFORE CLEANING.

Before switching on again, ensure that all controls are in the **OFF** position.

### Cleaning the Exterior

The outside of both ovens can be cleaned, when cooled down, using a cloth which has been rinsed in warm soapy water. The oven can then be wiped down with a clean dry cloth. **Never** use an abrasive powder as this will damage the surface.

### Lower Oven

Remove the rod shelves and meat pan.  
Use a fine steel wool soap pad to remove stubborn stains from the rod shelves, meat pan and the floor of the oven. Refer to the instruction opposite and on page 28 for cleaning the 'Stay Clean' panels.

**Do not use** aerosol cleaners on this oven as they could adversely affect the fan motor unit, and cannot be wiped off the fan blade.

### Decorative Trims

It is advisable to clean the decorative trims regularly to prevent any build up of soiling which may detract from the appearance of the Cooker. The recommended method of cleaning is to wipe over the trims with a soft cloth wrung out in hot water, or mild non-abrasive cleaner. (If in doubt try the cleaner on a small area of trim which is not noticeable in normal use), then after wiping with a cloth wrung out in clear water, dry with a soft clean cloth.

**Do not use scouring pads or abrasive cleaners/powders which may scratch the surface. Under no circumstances should abrasive cleaning materials be used on the Timer Lens.**

### Top Oven

Use a fine steel wool soap pad to remove stubborn stains from the rod shelves, grill pan and floor and roof of the oven.

### Stay Clean Oven Liners

Refer to the instructions below for cleaning the following Stay Clean panels; **Oven** – side and rear panels.

### How Stay Clean Oven Liners Work

The surfaces of the Stay Clean oven liners are treated on the mottled face with a special vitreous enamel which absorbs cooking soils. At temperatures of 220°C (425°F) or above, the special surface enables these soils to be slowly destroyed. The higher the temperature, the more effective it is. In most cases normal cooking operations at this temperature will permit this cleaning operation to proceed during cooking. However if higher cooking temperatures are not used regularly, it may be necessary, in order to prevent heavy soiling, to run the oven without meat pan, at maximum setting for a couple of hours. This may be necessary once a month or every two or three months depending on the type and amount of oven cooking.

## For Your Safety, Never ...

**NEVER** Leave children playing unsupervised where the oven is installed and in use.

**NEVER** Attempt to grill with the grill/oven oven door closed.

**NEVER** Allow children to sit or stand on any part of the appliance.

**NEVER** Store food stuffs in the same cabinet as the oven.

**NEVER** Store items above an oven that children may attempt to reach.

**NEVER** Operate the oven with the inner glass panel removed.

**NEVER** Remove the oven shelves when the oven is hot.

**NEVER** Use water to extinguish oil or fat fires.

**NEVER** Use the oven/grill as a space heater.

**NEVER** Cover oven interior and shelves with aluminium foil.

**NEVER** Heat up unopened food containers as pressure can build up causing the container to burst.

**NEVER** Attempt to clean the oven until the mains supply has been switched off and the oven is cool.

**NEVER** Defrost the meat and poultry by warming through in the oven.

**NEVER** Store any aerosols/flammable liquids etc. in adjacent cabinetry.

**NEVER** Store anything which might catch fire in or near the oven.

# The main parts of your Double Oven

**WARNING: DO NOT TOUCH THE GLASS DOORS AND TRIMS WHEN THE OVEN IS IN USE AS THESE AREAS CAN BECOME HOT.**

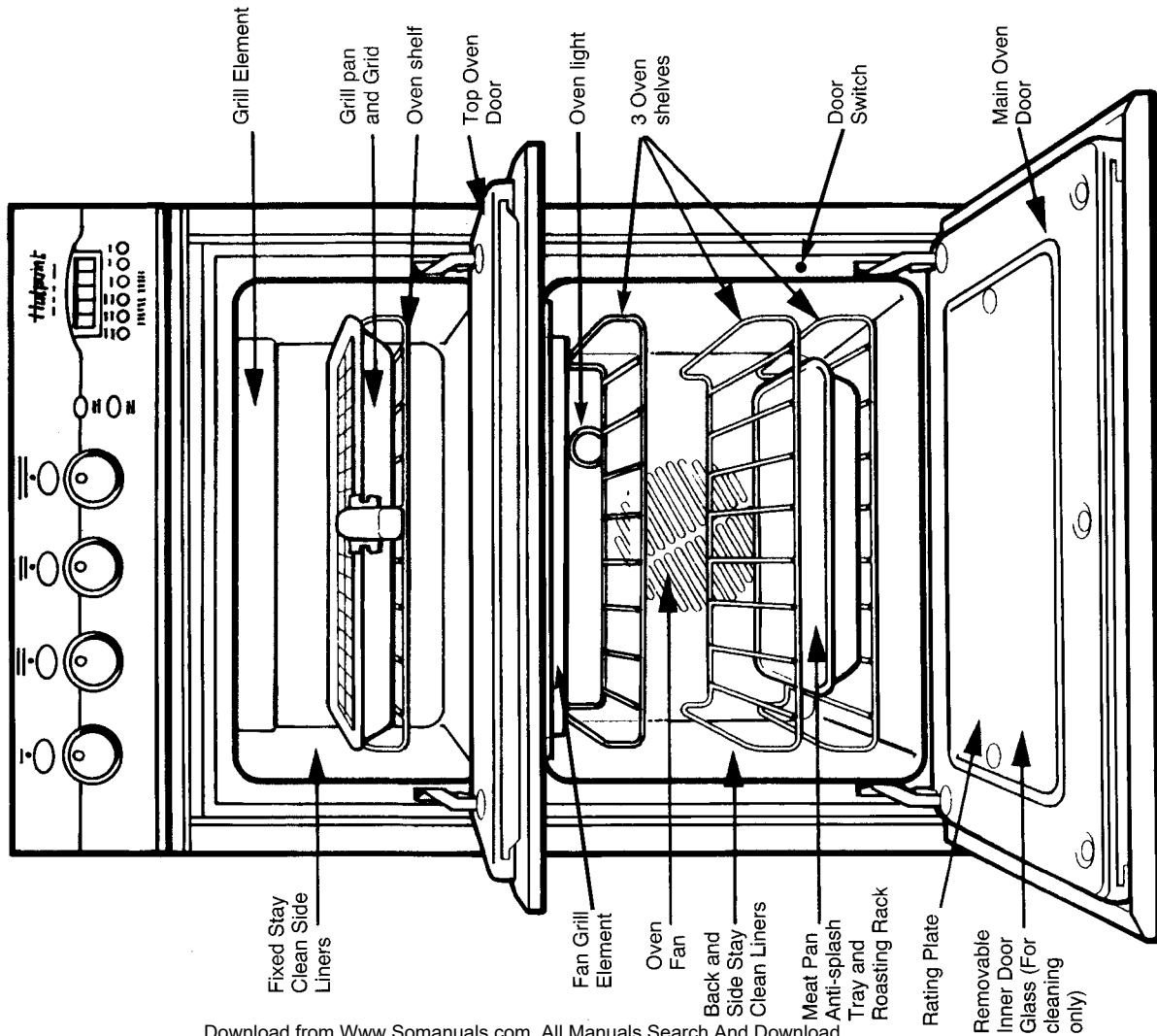

## Fan Only

### Defrosting Frozen Meat and Poultry

Joints of meat and whole birds should be defrosted slowly, preferably in a refrigerator (allowing 5-6 hours per lb), or at room temperature (allowing 2-3 hours per lb).

Frozen meat or poultry must be completely defrosted before placing in the oven.

The Main Oven has a Fan Only position. Set Multifunction Selector switch to Fan Only function - this can be used to assist defrosting by circulating the air around the food, time to defrost will depend on type and size of the food and the room temperature.

**DO NOT turn the temperature control on.**

**DO NOT defrost meat and poultry by warming the food through.**

Foods ideally suited for fan defrosting (without heat) are those which are normally served cold, e.g. cream/cream cakes, butter cream filled cakes, gateaux, cheese cakes, iced cakes, quiches, pastries, biscuits, bread, croissants, fruit and many delicate frozen foods.

If fish, meat and poultry are to be 'fan only' defrosted as selected on the Selector Switch (without heat), then where possible the items of food should be small and thin, eg. fish fillets, peeled shrimp, cubed or ground meat, sliced meat, thin chops, steaks or liver.

The items should be placed so the maximum amount of surface area is exposed to the circulating air and turned regularly to ensure even defrosting.

Fan defrosting without heat is only suitable for meat and poultry joints up to a maximum weight of 4lb.

**It is important to wash both roast and cooking utensils before defrosting.**

It is vitally important to strictly adhere to the basic principles of food handling and hygiene to prevent the possibility of bacterial growth.

### Defrosting

Food can be defrosted in the main oven as though it was thawing at room temperature, with the advantage that it is much quicker. The selector switch should be set at Fan Only and the food for defrosting placed on a tray.

**No heat is required for defrosting.**

## Cooking in the Lower Oven – Fan Cooking



### Operation

Turn the Multifunction Selector switch to the required function. The control panel illumination and oven light will remain on. Then set oven temp control to the required temperature. The oven thermostat light will immediately come on and remain on until the oven reaches the set temperature. This light will then automatically turn on and off during cooking and the oven will operate whilst the oven is switched on and door closed.

**Note:** If the thermostat light does not come on when the Oven Temp Control is turned, check that the Timer is in Manual Operation.

Since a fan oven heats up more quickly, and generally cooks food at a lower temperature than a conventional oven, pre-heating the oven is often unnecessary. However, foods such as bread, scones, Yorkshire pudding, do prefer to be placed in a pre-heated oven.

The charts on pages 21 and 22 are a guide only, giving approximate cooking temperatures and times. To suit personal taste and requirements, it may be necessary to increase or decrease temperatures by 10°C.

### Oven Positions

Since the distribution of heat in fan ovens is very even, most foods will cook satisfactorily on any shelf position, but the shelves should be evenly spaced. To ensure even circulation do not use meat pans larger than 390 x 300mm (15in x 12in) and baking trays no larger than 330 x 255 mm (13in x 10in), these should be positioned centrally on the oven shelf.

## The Cooking Systems in your Double Oven

Your new oven is equipped with five heating systems:

- 1. Conventional Heating (Top Oven)**  
- with upper and lower heat. This system is particularly suitable for roasting and baking on one shelf only.
- 2. Grilling (Top Oven)** - Has a full width, fully controllable grill. The grill also has an economy setting which enables you to use just the left section.  
**NOTE: The Top Oven Door should be fully open when grilling.**
- 3. Fan Cooking (Lower Oven)** - the fan oven operates by constantly blowing heated air from an element wrapped around the fan into the oven. This gives improved efficiency and, in general, allows you to cook at lower temperatures. It also means that there is less need to be particular about shelf positions and that you can bake at more than one level simultaneously (Batch Baking).
- 4. Fan Grilling (Lower Oven)** - controlled by the oven thermostat - this is a combination of heat from the grill element and hot air circulated by the fan. Joints of meat and poultry will be browned as if they were cooked on a rotisserie or spit but more economically as the door is left closed.
- 5. Thermostat Grilling (Lower Oven)** - can be used for conventional grilling with a full grill width. Use the lower oven thermostat control to set the required temperature.

**NOTE: The Lower Oven Door should be open at the detent position when grilling.**

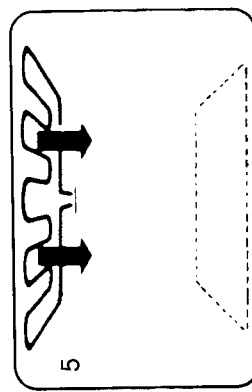
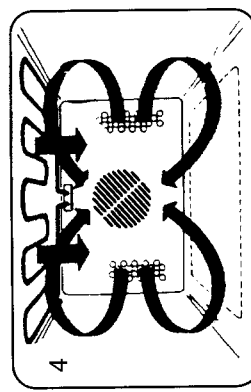
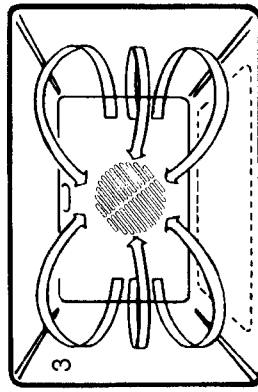
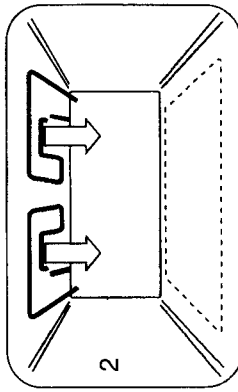
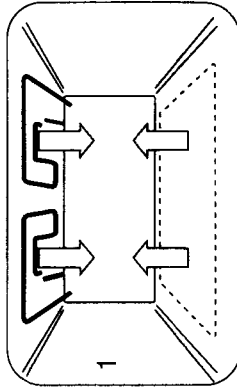

It should be noted that at the end of a cooking period there may be a momentary puff of steam when the oven door is opened. This will disperse in a few seconds and is a perfectly normal characteristic of an oven with a good door seal.

## Before Using the Oven for the First Time

**Make sure the electricity supply is switched ON.**

Please note that when the double oven is used for the first time a slight odour may be emitted due to the 'burning off' of any temporary finish on oven fittings and elements and the removal of moisture absorbed by the lagging. The odour will cease after a short period of use.

To remove the 'new smell', heat up the empty oven for 30 minutes keeping the door closed. Ensure illumination, and cooling fan.

that the room is well ventilated (eg, open a window or door) and that persons who may be sensitive to the odour avoid any fumes. It is suggested that any pets be removed from the room until the new smell has ceased.

Turn the selector switch to fan oven function, then turn oven thermostat to MAX. Also turn Top Oven/Grill selector to MAX

The oven temperature thermostat lights will come on as well as the interior light, oven fan, control panel illumination, and cooling fan.

## Temperature Conversion Scale

The chart below gives details of comparisons of oven settings for gas conventional ovens and fan oven in degrees °F and °C

GAS MARK	CONVENTIONAL OVEN		FAN OVEN
	°F	°C	°C
1/2	250	120	100
1	275	140	120
2	300	150	130
3	325	160	140
4	350	180	160
5	375	190	170
6	400	200	180
7	425	220	20
8	450	230	210
9	475	240	220

## Lower Oven Temperature Chart – Fan Grilling

Shelf positions are counted from the base upwards ie: lowest shelf position is 1.

Type of Meat or Poultry	Weight kg	Temp °C	Time (min/kg)	Plus Extra Time (mins)	Total Cooking Time (mins)	Tips	
PORK Pork Chop - thick		170	25		Dependent on size	Season, grill on shelf position 3. Turn over after 15 mins.	
Gammon Steaks		160	30		Dependent on size	Grill on shelf position 3 Turn after 15 mins.  Score fat with sharp knife and rub on salt. Pork should always be thoroughly cooked. So overcook rather than undercook. Grill on shelf position 1.	
Pork - any type of joint	1.0 1.5 2.0 2.5 over 2.5	160-170 150-170 140-150 140-150 140	60-70 60-70 65-75 65-75 70-75	45 45 50 50 50		Score fat with sharp knife and rub on salt. Pork should always be thoroughly cooked. So overcook rather than undercook. Grill on shelf position 1.	
LAMB Lamb chop - thick		170	25		Dependent on size	Season, Grill on shelf position 3. Turn over after 15 mins.	
Lamb - any type of joint	1.0 1.5 2.0 2.5 over 2.5	160-170 160-170 150-160 150-160 150	30-40 35-40 35-45 40-45 45-50	45 45 50 50 50		Score fat. Season with pepper and rosemary. If you prefer the lamb pink, choose the shorter time. Grill on shelf position 1.	
BEEF Beef - joints which have an outside layer of fat eg. Rib, Rolled, Sirloin	1.0 1.5 2.0 2.5 over 2.5	170-180 170-180 160-170 160-170 160	40-50 40-50 40-50 45-50 45-50	20 20 20 30 40		Season, if joint preferred rare grill for the shorter time, if preferred well done grill for the longer time. Grill on shelf position 1.	
CHICKEN	1.0 1.5 2.0 2.5 over 2.5 less than 1kg each	180 180 170 170 160-170 180	30 30 35 35 40 30	30 30 30 30 30 30		Season and brush over with melted butter to give nicely browned skin. Grill on shelf position 1.  Shelf 1.	
DUCK	1.5 2.0 2.5	180 180 180	30 30 35	30 30 30	75 90 115-130	Dry thoroughly and lightly salt. Grill on shelf position 1.	
GOOSE	up to 4 4-5	170-190 160-170	40 45	40 40		Can be stuffed. Grill on shelf position 1	
TURKEY	up to 5 6-8	170 150	-	-	150-165 165-175	Season and brush over with melted butter to give nicely browned skin. Grill on shelf position 1	
GAME Grouse Partridge Pheasant	Any Any Any	170-180 170-180 170-180	30-50 40-50 40-50	-		Well hung meat will require less cooking time, grill on position 1.	
Beefburgers Sausages Bacon Mixed Grill	450g(lb) 450g (lb) 450g (lb) 170	170 170 170 170	25mins per 450g (lb) 25mins per 450g (lb) 25mins per 450g (lb)		30	Shelf 3. Shelf 3. Prick sausages before cooking. Shelf 3. Roll up bacon before cooking. 4 pieces of steak, sausages, chops, bacon, tomatoes & mushrooms. Cook sausages, chops, bacon for 10 mins, add steak, cook for further 20 mins. Tomatoes & mushrooms should be placed on trivet under roasting rack for total cooktime.	

## Grilling in the Lower Oven Temperature Chart

Food	Preheat for 5 mins	Shelf Position from Base of Oven	Approx. Cooking Time
Toasting of Bread Products	230°C	6	3-10 mins. depending on type of food
Small cuts of meat, sausages, bacon, etc	150°C	5 or 6	5-15 mins
Chops etc	170°C	5	25-30 mins
Fish whole Fillets	170°C	5	10-15 mins
Pre-cooked potato products	200-230°C	6	10 mins
Pizzas	170°C	5	12-15 mins
Browning of Food	230°C	5	10-15 mins depending on type of food

The temperatures below relate to heat settings recommended on food packs

High = 230°C  
 Medium High = 200°C  
 Medium = 175°C  
 Medium Low = 150°C  
 Low = 130°C  
 Very Gentle = 100°C

Fan Grill

## Cooking in the Lower Oven - Fan Grilling

Fan grilling can only be carried out with the door closed. In this method of cooking, the fan and the full width grill element work together and has the same results as if you were cooking on a rotisserie but more economically with the door closed.

You can grill by this method anything from a thick chop to a large turkey or goose and they will be cooked more thoroughly, economically and will require less attention during the actual cooking period. In the case of large pieces of meat, the juices from the meat will drain into the meat pan and will form the basis for making delicious gravy. Furthermore anything cooked by this method as opposed to the more conventional

method of roasting or grilling will result in a cleaner oven.

There is no need to pre-heat the oven. Position the meat pan centrally under the Grill Element (with anti-splash tray and roasting rack in place) at shelf position 3, or shelf position 1 if very large pieces/items of food are being cooked.

Turn the Multifunction Selector Switch to Fan Grill and Thermostat to temperature required as shown in the chart on page 25. Turn the food over approximately halfway through cooking, taking care not to burn yourself.

The fan grilling operation can be selected/timed using the automatic oven timer. See pages 15 to 17. See Fan Grilling Roasting Chart on page 25.

## The Controls

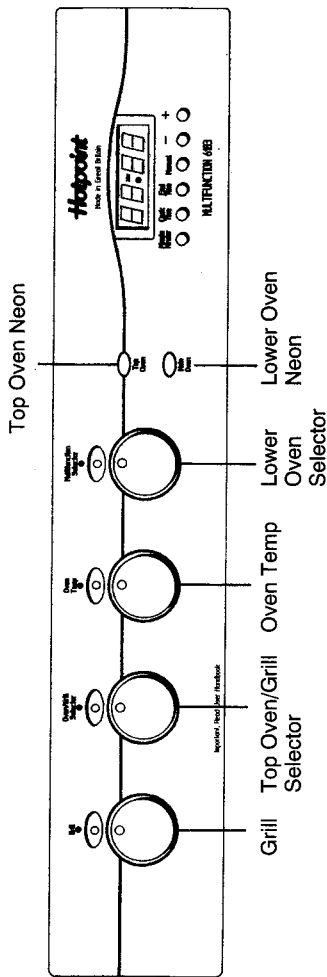

### IMPORTANT

Before using your oven, ALWAYS make sure that the timer has been set to MANUAL operation. Unless this is done, the oven cannot heat up. Before seeking assistance, make sure you have done this.

To select any feature simply press the selector knob centre to release the knob. Rotate the knob in either direction until the required function

appears in the window.

Many of the functions will also require the Oven Thermostat to be set to the required temperature, or Grill to the required setting. After use, both knobs can be returned to the storage/safety position by again pressing in the centre of the knob.

## Lower Oven Selector Switch Functions



**Off.** With the selector in this position the oven will be off with the exception of the Oven Clock display.



**Fan Grill** (Inner and Outer Top Elements and Fan). Use the Oven Temperature control to set the required temperature.



**Oven Light.** In this position the Oven Light will be on.



**Grill** (Top Element). Use the Oven Temperature Control to set the required temperature.



**Fan Only.** The Oven Temperature control must be set to the off position.



**Fan Oven** (Rear Element and Fan). Use the Oven Temperature control to set the required temperature.



# The Controls

## When Using the Top Oven

To use the Top Oven, you must turn the Top Oven/Grill Selector clockwise to the required temperature. The Top Oven thermostat light will immediately come on and remain on until the oven reaches the required temperature. It then cycles off and on during cooking as the thermostat maintains the oven temperature. If the thermostat light does not come on when the top oven is turned on, check that the oven is set to Manual (see pages 15 to 17). Always remember to keep the oven door closed. After use always set the Top Oven/Grill Selector back to 'O' (OFF) position.

## When Using the Grill (Top Oven)

Keep young children away from the appliance when the grill is in use as the surfaces get extremely hot. Grilling should not be undertaken with the grill/Top Oven door closed. Turn the Top Oven/Grill Selector clockwise past the thermostat settings to the half grill or full grill settings depending upon which you require. To set the heat of the grill turn the grill control clockwise to any setting between 1 & 6. After use always turn the Top Oven and grill controls anti-clockwise back to 'O' (OFF) position.

## When Using the Lower Oven

Turn the Multifunction selector switch to the required function (fan oven, fan grill, grill). Then set Oven Temp Control to the required temperature. The thermostat light will come on and remain on until the oven reaches the required temperature. The light will then cycle off and on as the thermostat maintains the oven temperature. If the thermostat light does not come on, check that Timer is set to Manual. (See pages 15 & 17).

## Platwarming

Turn the Top Oven/Grill Selector clockwise to the plate warming setting. Place the dishes to be warmed in the Top Oven (see page 20).

# Grilling in the Lower Oven

**Keep young children away from the appliance when the grill is in use as the surfaces get extremely hot.**

**Grilling should NOT be undertaken with the Oven door closed.**

Turn the Multifunction Selector Switch to Grill and the Oven temperature Control to the required temperature.

Grilling should be carried out with the oven door open (see fig. 6 below). It is advisable to pre-heat grill eg. for 5 mins. The grill pan with grid should be used at shelf position (see page 24) according to the various foods.

Position the grill pan directly under the heating element. For toasting and sealing fast cooking foods leave the oven temperature control at 230°C. For thicker foods requiring longer

## Grill

cooking times turn the Oven Temp. Control down to a lower temperature. The initial sealing of both sides at 230°C and the thicker the food, the lower the temperature on the Oven Temperature Control.

Food that only requires browning should be done on a lower shelf position. If excessive smoke is being emitted then turn the Oven Temp. Control to a lower setting and/or move the grill pan to a lower position.

After use, both controls should be returned to the OFF position.

**NOTE: The grill pan must be cleaned after every use. Excess fat build up in the bottom of the pan could cause a fire hazard.**

The grill will only operate when the oven temperature control and the Main Oven Selector have been set.

**NOTE: Ensure that the oven timer is set at MANUAL**

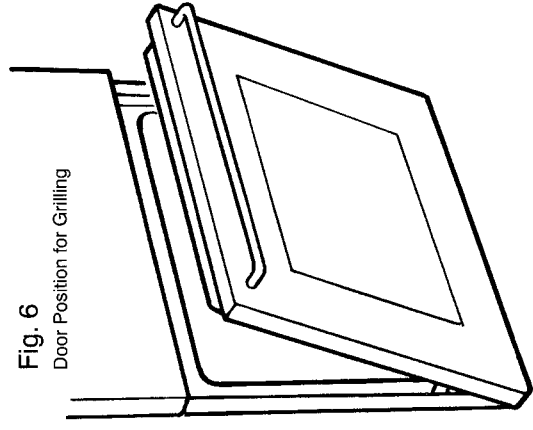
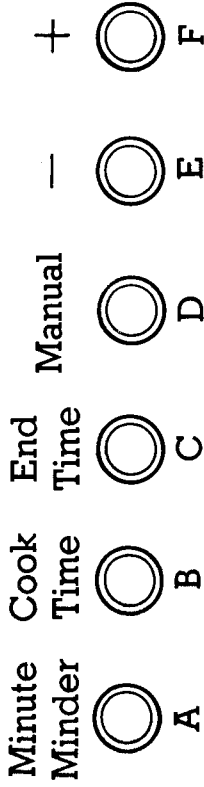
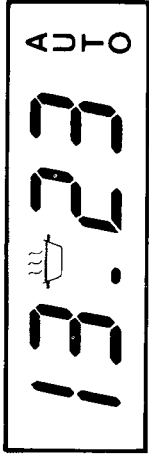

Fig. 6  
Door Position for Grilling

The oven door is designed to remain open at the position shown.

# The Automatic Oven Timer



The oven timer offers you the following features:

1. Time of Day
2. Minute Timer
3. Automatic Cooking with cook and delay cooking functions.

press the + button F and continue to hold until you have set the required cooking time. (If you overshoot the required cooking time press - button E until cooking time is set.) Note: COOK TIME refers to duration of cooking.

**NOTE:** When COOK TIME IS cancelled by pressing the - button E, END TIME is automatically cancelled and AUTO flashes on and off. Press MANUAL button D, to remove AUTO.

2. When the cook time has been set, press and release the **end time** button C and then within 2 seconds press the + button F. (The display will start off by showing the earliest possible end time.) Continue to hold in the button until the time you require the food to be cooked by appears in the display. (If you overshoot the required time press the - button E).
3. Release the buttons, the display will revert to the time of day with the auto symbols lit.

**To set the Timer to switch ON and OFF automatically.**

1. Press and release the **cook time** button B and within 2 seconds

Meat	Top Oven Cooking - Conventional Oven		Lower Oven Cooking - Fan Oven			
	Pre-heat Temperature °C	Time (approx.)	Pre-heat Temperature °C	Time (approx.)		
Meat	Runner 1 from bottom of oven.	Beef/ Lamb (slow roasting)	Yes	170/180	20-25 mins per 450g (1lb) + 35 mins over.	
		Beef/ Lamb (foil covered)	Yes	190/200	35-40 mins per 450g (1lb)	
		Pork (slow roasting)	Yes	170/180	40 mins per 450g (1lb) + 40 mins over	
		Pork (foil covered)	Yes	190/200	40 mins per 450g (1lb)	
		Veal (slow roasting)	Yes	170/180	40-45 mins per 450g (1lb) + 40 mins over	
		Veal (foil covered)	Yes	190/200	40-45 mins per 450g (1lb)	
		Poultry/Game (slow roasting)	Yes	170/180	25-30 mins per 450g (1lb) + 25 mins over	
		Poultry/Game (foil covered)	Yes	190/200	25-30 mins per 450g (1lb)	
		Casserole Cooking	Yes	150	2-2½ hrs	
		Meat	Runner 1 from bottom of oven.	Beef	No	160/180
Lamb	No			160/180	20-30 mins per 450g (1lb) + 25 mins extra	
Pork	No			160/180	25-30 mins per 450g (1lb) + 25 mins extra	
Veal	No			160/170	25-30 mins per 450g (1lb) + 25 mins extra	
Chicken/ Turkey	No			160/180	18-20 mins per 450g (1lb) + 20 mins extra	
Casserole Stews	No			140-150	1 ½ - 2 Hrs	
Turkey 4 to 5.5kg (8 to 12lb)	No				13-15 mins per 450g (1lb) at 150/160°C allow 12 mins per 450g at 150°C	
over 5.5kg (12lb)	No					

The most accurate method of testing the readiness of joints of meat or whole poultry is to insert a meat thermometer into the thickest part of a joint, or the thickest part of poultry thighs, during the cooking period. The meat thermometer will indicate when the required internal temp has been reached.

- Beef - Rare: 60°C, Medium: 70°C, Well Done: 75°C
- Lamb: 80°C, Pork: 90°C, Veal: 75°C
- Poultry: 90°C

4. Turn the Multifunction selector switch to the desired function, ie: (Fan Oven or Fan Grill) Then set the Oven Temp Control to the required temp for the Lower Oven. For the Top Oven turn the Top Oven/Grill Selector to the required temperature. The oven will now automatically switch on at the preselected time and switch off once the cook time has elapsed.

5. On your return to the oven, turn off the oven control and return the timer to Manual by pressing button D. If on your return to the oven **0.00** is showing in the display, this shows that there has been a power failure and the food is unlikely to be cooked. Reset the correct time.

#### To set the Timer to switch OFF automatically.

1. Press and release the cook time button B and within 2 seconds press the + button F and continue to hold until you have set the required cooking time. (If you overshoot the required cooking time press the – button E until cooking time is set.)
2. Release the buttons, the display will revert to the time of day with the auto symbols lit.
3. Turn the Multifunction selector switch to the desired function, ie: (Fan Oven or Fan Grill) Then set the Oven Temp Control to the required temp for the Main Oven. For the Top Oven turn the Top Oven/Grill Selector to the required temperature. The oven will cook now and automatically switch off once the cook time has elapsed.

4. When the food has been cooked always turn the oven control to the **OFF** position and return the timer to Manual by pressing button D.

5. If on your return to the oven **0.00** is showing in the display, this shows that there has been a power failure and the food is unlikely to be cooked. Reset the correct time.

#### To Cancel a Delayed Cooking Programme

An automatic cooking programme, once set, (see items 1 - 5 opposite) may be cancelled as follows:

1. Press the Cook Time button (B) followed by the – button (F) keeping both buttons depressed until the display shows '0.00' with the 'AUTO' symbol still on.
2. On releasing both buttons the oven is returned to manual operation by pressing the Manual (D) button, which also cancels the Automatic Cooking Symbol. The Cooking Symbol  will now show.

#### Minute Minder

1. Press and release Minute Minder button A and within 5 seconds press the + button F and continue to hold until you have set the required time (if you overshoot the required time press the – button E).
2. After releasing the button, the display will revert to the time of day. During the delay period, the time can be checked by pressing the Minute Minder button A.
3. At the end of the set time a tone will sound for a short period of time to cancel press button A.

## Cooking Temperature Charts

Food	Pre-heat	Temperature °C	Top Oven Cooking - Conventional Oven		Lower Oven Cooking - Fan Oven	
			Position in Oven	Time in mins.	Pre-heat	Temperature °C
Scones	Yes	210/220	Runner 1 from bottom of oven.	9-12	Yes	210/220
Small Cakes	Yes	180/190	Runner 1 from bottom of oven.	15-20	No	170/180
Victoria Sandwich	Yes	170/180	Runner 1 from bottom of oven.	20-25	No	160/170
Sponge Sandwich	Yes	180/190	Runner 1 from bottom of oven.	15-20	Yes	170/190
Swiss Roll	Yes	200/210	Runner 1 from bottom of oven.	10-15	Yes	180/200
Semi-rich cakes	Yes	160/170	Sheet placed on shelf of oven.	75-90	No	140/150
Rich Fruit Cakes	Yes	140/150	Dependent on size	Dependent on size	No	130/140
Shortcrust Pastry	Yes	190/200	Dependent on use	Dependent on use	No	190/200
Puff Pastry	Yes	200/210	Dependent on use	Dependent on use	No	190/200
Yorkshire Pudding	Yes	190/200	Runner 1 from bottom of oven.	40-50	Yes	180/190
Indiv. York. Pudd.	Yes	200/210	Runner 1 from bottom of oven.	20-25	Yes	190/200
Milk Pudding	Yes	140/150	Runner 1 from bottom of oven.	120-150	No	130/140
Baked Custard	Yes	140/150	Runner 1 from bottom of oven.	45-50	No	140/150
Bread	Yes	200/210	Sheet placed on floor of oven	25-30	Yes	200/210
Meringues	Yes	100	Runner 1 from bottom of oven.	180-240	No	70-90

Note: If soft margarine is used for cake making, temperatures recommended by the manufacturers should be followed. Temperatures recommended in this chart refer to cakes made with block margarine only.



## Cooking in the Top Oven – Conventional Cooking

The Top Oven can be used to cook small quantities of food or used in conjunction with the Main Oven to provide additional cooking space so often necessary when entertaining.

The oven is designed so that the grill element operates at a reduced heat output (element will not glow), combined with a heating element situated underneath the floor of the oven.

### **Do not place items directly onto the floor of the oven.**

To ensure even cooking of the food it is important that cooking utensils are positioned correctly on the oven shelf directly beneath the element. (As a guide, the front of the utensil should be approximately 100 mm/4 in from the front of the shelf.)

There are two cooking positions, the shelf placed directly on the floor of the oven or runner 1 (from the base).

### **Food or utensils must never be placed directly on the floor of the oven.**

There should always be at least 25mm (1 in) between the top of the food and the grill element. Do not use utensils larger than 300mm x 230mm (12in x 9in). Larger utensils should be used in the Main oven.

### **Operation**

To heat the oven, turn the Top Oven/Grill Selector clockwise, selecting the required temperature between 100°C (200°F) and 220°C (425°F) as recommended in the Top Oven Temperature Charts. The Top Oven indicator light will immediately come on and remain on until the oven

reaches the required temperature. The indicator light will then automatically go off and on during cooking as the thermostat maintains the correct temperature. If the indicator light doesn't come on when the control knob is turned, check that the oven timer is set to Manual as described in 'Oven Timer Operation'.

### **Cooking Meat/Poultry in the Top Oven**

The Top Oven is most useful for the longer slower cooking required for cheaper cuts of meat – casserole cooking, pot roasting, braising etc. Small joints of meat up to 1.5 kg (3lb), or poultry, up to 3.6 kg (8lb) in weight can be roasted in a small meat pan in the Top Oven, but should preferably be 'slow roasted' or covered with a lid of aluminium foil (one or two incisions in the top of the foil will allow the meat or poultry to brown).

Larger joints of meat, and poultry weighing more than 3.6 kg (8lb), should be roasted in the Main Oven.

### **Do not use the Main Oven meat pan or the grill pan as a meat pan in the Top Oven as air circulation will be seriously restricted.**

### **Top Oven as a Warming Compartment for Plates and Dishes**

Place the plates and dishes on the shelf that has been positioned on the floor of the oven and turn on the Top Oven/Grill Selector clockwise to the Platewarming position for 10-15 minutes. **DO NOT** use the grill control.

**NOTE:** To give yourself more time to set each function, press and hold the required function button and at the same time press + or – button. The display will remain in the set mode until all buttons have been released.

### **Automatic Cooking**

The Grill will not function when the oven is set to cook automatically.

### **Hints on Automatic Cooking**

1. Select foods which will take the same time to cook and require approximately the same temperature.
2. Set the oven timer so that the food has just finished or about to finish cooking on your return to the oven. This will ensure the food has not cooled down and does not require reheating before serving.
3. Food should be as cold as possible when it goes into the oven, ideally straight from the refrigerator. Frozen meat and poultry should be thawed thoroughly before it is put into the oven.
4. We advise that warm food should never be placed in the oven if there is to be a delay period. Stews prepared by frying the meat and vegetables should be cooked as soon as possible.
5. We advise dishes containing left over cooked poultry or meat, for example shepherd's pie, should not be cooked automatically if there is to be a delay period.
6. Stews and joints should be cooked by the long slow method, so that the delay period is kept to a minimum.

7. On warm days, to prevent harmful bacteria growth in certain foods (ie: poultry, joints, etc) the delayed start should be kept to a minimum.

8. Wine or beer may ferment and cream may curdle during the delay period, so it is best to add these ingredients just before serving.

9. Foods which discolour should be protected by coating in fat or tossing in water to which lemon juice has been added, prior to placing food in the oven.

10. Dishes containing liquid should not be filled too full to prevent boiling over.

11. Foods should be well sealed (but not airtight) in a container to prevent the loss of liquid during cooking. Aluminium foil gives a good seal.

12. Ensure food is cooked thoroughly before serving.

## Grilling in the Top Oven

Keep young children away from the appliance when the grill is in use as the surfaces get extremely hot.

Grilling should NOT be undertaken with the Grill/Top Oven door closed. (See below)

**Never:** Line the grill pan with aluminium foil.

The grill control provides variable heat control of the grill element and will only operate once the oven control has been set to a grill position (fully clockwise).

The grill regulator is designed to provide variable heat control of either the twin grill elements on together or the single left-hand grill element only, depending on which mode you select:

To select twin grill, first turn the Top Oven/Grill Selector clockwise to Full Grill.

The heat can now be adjusted by setting the grill regulator.

To select single grill turn the Top Oven/Grill Selector clockwise to Half Grill.

Food which requires browning only should be placed under the hot grill directly on the shelf in the first or second runner from the bottom of the oven, according to the depth of the dish.

**Care should be taken when removing the grill pan during or directly after use.**

After use, always return both controls anticlockwise to the OFF position.

**NOTE: The grill pan must be cleaned after every use. Excess fat build up in the bottom of the pan could cause a fire hazard.**

The heat can now be adjusted by setting the grill regulator.

**Please note that the Grill will not operate unless the Top Oven/Grill Selector is in a grill position.**

**After use, turn both controls ANTI-CLOCKWISE to their off positions.**

### Grill Procedure

Ensure oven timer is set to Manual. Pre-heat the grill at setting 6 for approximately 5 minutes.

When toasting/grilling, the rod shelf is placed in either the first or second runner position from base. The grill pan is placed on the shelf and pushed back as far as possible to correctly position it under the grill element. Leave the control at 6 for toast, and for sealing and fast cooking of foods. For thicker foods requiring longer cooking, turn the switch to a lower setting after the initial sealing on both sides at 6. The thicker the food, the lower the control should be set.

### Fixing the Grill Pan Handle

Fix the grill pan handle securely in position before use.

The grill pan handle is detachable from the pan, to facilitate cleaning and storage.

The handle fits onto the grill pan edge with the small recess, Fig. 5.

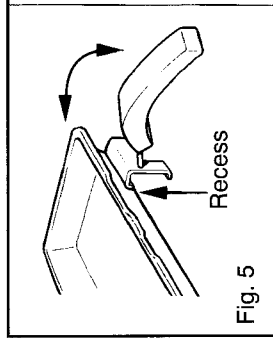

Fig. 5

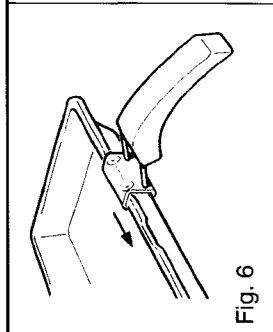

Fig. 6

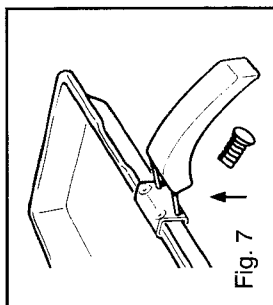
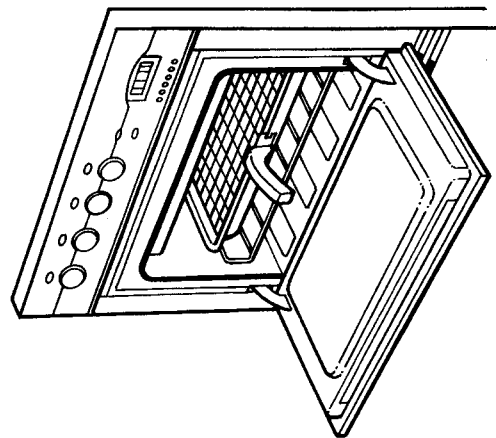

Fig. 7

Tilt the handle over the recess and slide it towards the centre, Fig. 6. Ensure the handle is fully located Fig. 7.

Insert the washer and fixing screw and tighten fully to ensure handle is secured.

Always fit the screw prior to use.



## Free Manuals Download Website

<http://myh66.com>

<http://usermanuals.us>

<http://www.somanuals.com>

<http://www.4manuals.cc>

<http://www.manual-lib.com>

<http://www.404manual.com>

<http://www.luxmanual.com>

<http://aubethermostatmanual.com>

Golf course search by state

<http://golfingnear.com>

Email search by domain

<http://emailbydomain.com>

Auto manuals search

<http://auto.somanuals.com>

TV manuals search

<http://tv.somanuals.com>