

# Service - Hotpoint Electric Cooking

Please carry out the checks detailed on the **Something Wrong** page. If there is a problem with your appliance then contact your Service Centre by using the table below to identify the appropriate phone number.

Please have the following information available when you call :

- (a) Your name.  
(b) Your address and postcode.  
(c) Your telephone number.

2. The date and the name of the shop/retailer where the appliance was purchased.

Shop / Retailer : \_\_\_\_\_ Date : \_\_\_\_\_

3. The Model number and Serial number of your appliance (See Features page for Rating plate location).

Model Number : \_\_\_\_\_ Serial Number : \_\_\_\_\_

4. Clear and concise details of the fault.

5. Details of any Extended Warranty or Service Insurance Schemes.

## Your In-Guarantee Service Telephone Number

The arrangements for In-Guarantee Service depend upon which Retail Outlet you purchased your product from.

Shop / Retailer from where your appliance was purchased	Telephone Number for In-Guarantee Service
Just Rentals	01 443 441 111
Hydro Electric / Scottish Hydro	0800 300 000
Any Other Shop / Retailer - UK	0541 500 500
- Republic of Ireland	1850 302 200

If you have any other queries regarding Service or Parts, our Parts and Service division will be pleased to help. You should write to :

**Hotpoint Service, Customer Service Department, Morley Way, Peterborough. PE2 9JB**

For Parts and Accessories, please telephone our Parts Order Hotline on  
**0541 530 530 (UK) or 01 842 6836 (Republic of Ireland).**

**Note 1 :** If under guarantee, our Engineers will need to see a copy of your purchase receipt when they call.

**Note 2 :** Our Engineers will use every effort to avoid damage to floor coverings and adjacent units when carrying out repair/service work, but in locations where the Engineer advises you that it will be impossible to move the appliance without risk of damage, he will only proceed with your approval that no liability will be accepted.

# FULL INSTRUCTIONS FOR INSTALLING AND OPERATING YOUR HOTPOINT DOUBLE OVEN MODEL BD31/51

# Hotpoint®

# Before you operate your new Hotpoint Double Oven

Please read these instructions fully.

**ENSURE THAT THE OVEN IS INSTALLED BY A QUALIFIED ELECTRICIAN  
FOLLOWING THE INSTRUCTIONS BELOW.**

1. Your oven should not be located adjacent to a gas hob/heater or eye level grill as flames from the burners could cause damage to your oven.
2. For your own safety and to get the best results from your oven it is important to read through this Handbook **before** using your oven for the first time including the Always and Never on pages 8 and 9.

## Electrical Requirements

- For your own safety, we recommend that your cooker is installed by a competent person – such as one who is registered with NICEIC (National Inspection Council for Electrical Installation Contracting). The cooker should be installed in accordance with the latest Edition of the IEE Regulations.

**WARNINGS – INCORRECT INSTALLATION COULD AFFECT THE  
SAFETY OF THE OVEN.  
– THIS APPLIANCE MUST BE EARTHED.  
– BEFORE CONNECTING OR INSTALLING THE OVEN THE  
ELECTRICITY SUPPLY MUST BE SWITCHED OFF.**

- **THE INSTALLER MUST** check that the voltage shown on the rating plate corresponds with the house electricity supply.
- The oven must be supplied via a suitable double pole isolating switch, having a contact separation of at least 3 mm in all poles placed in a readily accessible position adjacent to the unit.
- The maximum loading for your oven is 5.2kW.
- If the oven is to be wired into a connector unit this may be positioned behind the oven provided the following requirements are met:
  - i) The connector unit must not project from the wall more than 25 mm.
  - ii) The top of the connector must not be more than 350 mm above the base of the oven recess.
- After unpacking the oven stand it on the packing base in order to avoid damage.

## Electrical Connections

- Remove the terminal cover at the rear base of the oven. Pass the cable through the cable clamp and connect to the appropriate terminals provided. Allow sufficient cable so that the oven can be set down on the floor whilst still connected up. Tighten the screws on the cable clamp and replace the terminal cover. Make mains connections.  
This appliance conforms to EN55014 regarding suppression of Radio and Television reception interference.  
Where a double oven is used a 32 amp double pole control switch should be used to feed the unit using a suitable rated cable. We recommend that a minimum of 4mm<sup>2</sup> PVC insulated twin and earth cable conforming to B.S. 6004.
- Where a hob is fitted adjacent to an oven then a 45 amp Double Pole control switch should be used to feed both units via separate suitably rated cables. We recommend that a minimum of 4mm<sup>2</sup> PVC insulated twin and earth cable conforming to B.S. 6004.

**WARNING: CHILDREN SHOULD NOT BE ALLOWED TO PLAY WITH THE  
APPLIANCE OR TAMPER WITH THE CONTROLS.**

# Hotpoint Service Cover

## Satisfaction Guaranteed or Your Money Back

Hotpoint gives you a unique 'Satisfaction Guaranteed' promise – valid for ninety days after you have purchased your Hotpoint product. If there is a technical problem with your Hotpoint appliance, just call Hotpoint Service (see back page). If necessary we will arrange for an engineer to call. If the technical problem is not resolved under this Guarantee, Hotpoint will replace your appliance or, if you prefer, give you your money back. Your statutory rights are not affected, and the Guarantee is additional and subject to the terms of Hotpoint's Five Year Parts Guarantee.

## Hotpoint's Free Five Year Guarantee

- From the moment your appliance is delivered Hotpoint guarantees it for **FIVE YEARS**.
- In the Five Years all replacement parts are **FREE** provided that they are fitted by our own Service Engineer. During the first year our Engineer's time and labour is also free.
  - Our guarantee covers loss of food in our refrigeration and freezer products up to £250 during the first year, subject to verification by one of our engineers.
  - After the first year we will charge for our Engineer's time and labour. We do, however, operate a range of Service Plans (see opposite) which, for an annual payment, enables you to cover any repair costs which may be necessary.
  - All our service repairs are guaranteed for twelve months in respect of our labour and any parts fitted.
  - The appliance must be used in the United Kingdom, and must not be tampered with or taken apart by anyone other than our own Service Engineers.
  - You may, however, buy parts which can be safely fitted without specialist knowledge or equipment. The correct fitting of such parts, provided they are genuine Hotpoint spares, will not affect your Guarantee. Parts are available from our Hotpoint Spares Centres (see back page).
  - Our guarantee does not cover the cost of any repair, or loss of food in refrigeration products, due to power failure, accidents or misuse. Nor does it cover the cost of any visits to advise you on the use of your appliance. Please read thoroughly the instruction book supplied with this appliance.
  - If at any time during the Guarantee period we are unable to repair your appliance, we will refund any repair costs paid to us in the previous twelve months. We will also offer you a new appliance at a reduced charge instead of a repair.
  - Our Guarantee is, in addition to and does not affect your legal rights.
  - Should you need independent advice on your consumer rights, help is available from your Consumer Advice Centre, Law Centre, Trading Standards Department and Citizens Advice Bureau.
  - All Hotpoint servicing is carried out by our own Service Organisation located throughout the United Kingdom and Eire. We will be happy to deal with any problems which you may have.

## Hotpoint's Extended Warranties

Whether you have just one or a number of Hotpoint appliances in your kitchen, Hotpoint has a range of Service Plans to give you complete peace of mind. They enable you to extend your one year labour guarantee so that you can have repairs completed **FREE** during the membership period.

### Service Cover

We offer a number of payment methods: cheque, credit card or you can spread the cost and pay by direct debit (full details can be obtained on Free phone 0800 716936). This covers you for all repairs during the period of cover, which can be from 1 to 4 years. Service Cover also includes loss of food, up to the value of £250, in refrigeration appliances. There is also an option of Service Cover with Maintenance at an additional cost. This includes an annual Electrical and Safety check and replacement of any parts as necessary.

### Kitchen Cover

An annual payment covers you for all repairs for all your Hotpoint appliances which are less than ten years old. It also covers the cost of loss of food up to £250 in our refrigeration and freezer products. There is also the option of Kitchen Cover with Maintenance at an additional cost. Any additional Hotpoint appliances purchased after you have joined Hotpoint Kitchen Cover will automatically be included during the annual period of cover without further charge.

### Appliance Registration

To ensure that you have the opportunity to benefit from any of the above Service Schemes and other offers you should complete and return immediately the Appliance Registration Form/Questionnaire supplied with this appliance. Full details and costs of our Service Schemes, together with an application form, will be sent to you at the end of the first year of the guarantee.

### Annual Safety/Maintenance Checks

Hotpoint strongly recommends that all its appliances are regularly checked for electrical and mechanical safety, whether or not they are covered by a Service Plan. Worn door gaskets or hoses may cause a leak on an appliance, which could become dangerous if neglected.

### Proof of Purchase

For future reference please attach your purchase receipt to this booklet and keep it in a safe place.

### Spares and Accessories

Spares and accessories can be ordered from your local Hotpoint Spares Centre (see back page), using the order form enclosed.

**NOTE:** Our Engineers will use every effort to avoid damage to floor coverings and adjacent units when carrying out repairs/service work, but in locations where the Engineer advises you that it will be impossible to move appliances without risk of damage, he will only proceed with your approval that no liability is accepted.

## PLEASE READ THIS BOOKLET CAREFULLY.

## Contents

Before you operate your new Hotpoint Double Oven	2
Electrical Requirements	2
Installation Instructions	4-7
For Your Safety - Always	8
Never	9
The main parts of your Double Oven	10
The cooking systems in your Double Oven	11
Before using your Oven for the first time	12
Temperature Conversion Scale	12
Controls	13-14
The Automatic Oven Timer	15-18
Grilling in the Top Oven	20-21
Cooking in the Top Oven - Conventional Cooking	22
Cooking Temperature Charts	23-24
Cooking in the Lower Oven - Fan Cooking	25
Fan Only	26
Eco Cooking – Lower Oven	27-35
Care and Cleaning	36-38
If Something Goes Wrong	41-41
Hotpoint Service Cover	42
Hotpoint Service and Spares	Back Cover

## Retention of this Instruction Book

This Instruction Book must be kept handy for reference as it contains important details on the safe and proper use of the appliance.

If you sell or pass the appliance to someone else, or move house and leave it behind, make sure this Book is also provided so the new owner can become familiar with the appliance and safety warnings.

If the Book is lost or damaged a copy may be obtained from Hotpoint Ltd, Celta Road, Peterborough, PE2 9JB.

When first using the cooker ensure that the room is well ventilated (e.g. open a window or use an extractor fan) and that persons who may be sensitive to the odour avoid any fumes. It is suggested that any pets be removed from the room until the smell has ceased. This odour is due to temporary finish on oven liners and elements and also any moisture absorbed by the insulation.

## DISPOSAL OF YOUR PRODUCT

To minimise the risk of injury to children please dispose of your product carefully and safely. Remove all doors and lids (where fitted). Remove the mains cable (where fitted) by cutting off flush with the appliance and always ensure that no plug is left in a condition where it could be connected to the electricity supply.

To help the environment, Local Authority instructions should be followed for the disposal of your product.

# Installation Instructions

Ensure that the electricity supply is turned off before installing your appliance.

## **IMPORTANT DO NOT LIFT OVEN BY THE DOOR HANDLES.**

This equipment is designed specifically for domestic purposes and Hotpoint Limited cannot accept responsibility if used for any other type of application.

**All electrical installations must be carried out by a NICEIC registered installer.**

**WARNING: THIS APPLIANCE MUST BE EARTHED.**

### 1. General

The appliance is designed for mounting at a safe level into an open housing which must be secured to the backing wall.

### 2. Oven Unit Housing Cabinets

- a. The oven unit housing cabinet dimensions must comply with Fig. 4. (See pages 6 and 7.)
- b. An air gap of 50 mm minimum must be provided at the rear of any top or bottom cupboards or shelves. (See Fig. 1 page 6.)
- c. Ventilation must be unobstructed, ie. from adjacent cabinetry. This can be done by either raising the base of the cabinets using the adjusting feet (or spacers) or alternatively by providing a slot in the cabinet plinth to the dimensions shown overleaf.
- d. The air gap at the rear allows the warmed air to pass out of the inner cabinet space, but where it is intended to fit

cupboards above the oven unit to ceiling height it is essential that the warmed air is exhausted through the front of the cabinet Fig. 1. (See page 6.)

- e. If an oven unit is installed adjacent to a tall cabinet, steam escaping from the oven when the door is opened could condense on, and perhaps stain, the adjacent surface. To prevent permanent staining, the adjacent surface should be made of a material that is heat resistant and easy to clean. Adjacent tall cabinets should not be deeper than the oven housing cabinet.

### **IMPORTANT**

It is essential that the lower cupboard is constructed in the manner illustrated see pages 6 and 7 ie. having side, back and roof panels so joined as to provide no apertures which could permit access to the oven unit when installed.

### 3. Final Installation

- a. Using a spirit level, check that the housing cabinet is level from side to side and from front to back in its installed position.
- b. Correct any unevenness by placing wooden packing under the bottom of the cabinet. Make sure that the cabinet rests firmly on the cabinet floor without rocking
- c. Before the oven is fitted, the cabinet must be firmly secured to the backing wall for stability.

## If something goes wrong...

### Grilling is uneven

Ensure that Grill pan has been positioned as stated in the Grilling section of this book.

### Oven lamp does not work

The oven lamp is not covered by the guarantee. The part is easily changed (see the section on oven lamp replacement) A new lamp may be obtained from our Spare Parts department by calling: 0541 530530

### Condensation on the wall at the rear of the cooker.

Steam and / or condensation may appear from the vent at the rear of the appliance when using an oven particularly for foods with a high water content e.g. frozen chips, roast chicken etc. This is normal, and any excess should be wiped off.

### Steam / Condensation in the oven after use.

Steam is a by - product of cooking any food with a high water content. To help minimise always:  
a) Try to avoid leaving food in the oven to cool after being cooked.  
b) Use a covered container, wherever possible.

**If you have been through the above list and there is still a problem, You should identify your Service Agent using the list on the back page and contact your Local Service Office.**

## If something goes wrong...

Before calling a Service Engineer, please check through the following lists.  
**THERE MAY BE NOTHING WRONG.**

**Slight odour or small amount of smoke when grill / oven used first time**

This is normal and should cease after a short period.

**Nothing Works**

If you find that the timer display is blank, then it is likely that there is no electricity supply to your oven. Check:

- (i) That the main cooker wall is switched on
- (ii) Other appliances, to see if you have had a power cut
- (iii) The main circuit breaker for the property

**Timer Display shows "0:00" with "Auto" Flashing**

The power supply to your oven has possibly been interrupted, but has now come back on again. Reset the timer to the correct day and "Manual" operation using the instructions given in the timer section of the book.

**Main oven and Top ovens do not work, but the grill works**

Your timer may be set for an Auto Cooking programme: Check the timer to see whether "Auto" is lit or flashing. If it is then please follow the instructions given in the Timer section of this book to return the timer to Manual operation.

**Top oven and grill do not work, but Main oven works.**

Operating the cooker under the following conditions may cause a safety device to operate:

- (a) Grilling with the door closed - Always grill with the door fully open
  - (b) Grilling for an excessively long period at maximum setting - see Grilling guide.
- Switch off appliance and allow to cool for approx 30 mins. Switch the cooker back on and check that the Grill / Top oven is now operating.

**Grill does not work**

Ensure that the top oven control is in the off position.

**Grill keeps turning on and off**

When the Grill control is operating at less than its maximum setting, the Grill will cycle on and off, this is normal and **not** a fault.

**Timer buzzer / bleeper operates continually**

The bleeper will stop automatically after several minutes. To cancel, press the minute minder button to silence.

**Oven temperatures too high or low**

Check temperature and shelf positions are as recommended in the Oven Temperature Charts. It may be necessary to increase or decrease the recommended temperature slightly to suit your taste.

**Oven does not cook evenly**

Check:  
(a) Temperature and shelf positions are as recommended in the Oven Temperature Charts.  
(b) Oven utensils being used allow sufficient air flow around them.

## Installation Instructions

- d. Affix the correct number of self adhesive spacer pads to the outside of the side trims over the fixing holes to make up to the actual cabinet aperture (see Fig. 3 page 7).
- e. The oven unit should now be lifted (by 2 adults) into the cabinet and pushed fully home. (Care should be taken not to dislodge the spacer pads.)
- f. Finally the oven unit must be secured to the cabinet by means of the four pozi wash head screws, two through each side trim.
- g. **REMOVE ALL PACKING MATERIAL FROM THE GRILL AND OVEN INTERIOR.**

### List of Loose Items

- 4 x Pozi Wash Head No. 6 x 15mm screws.

Fig. 2

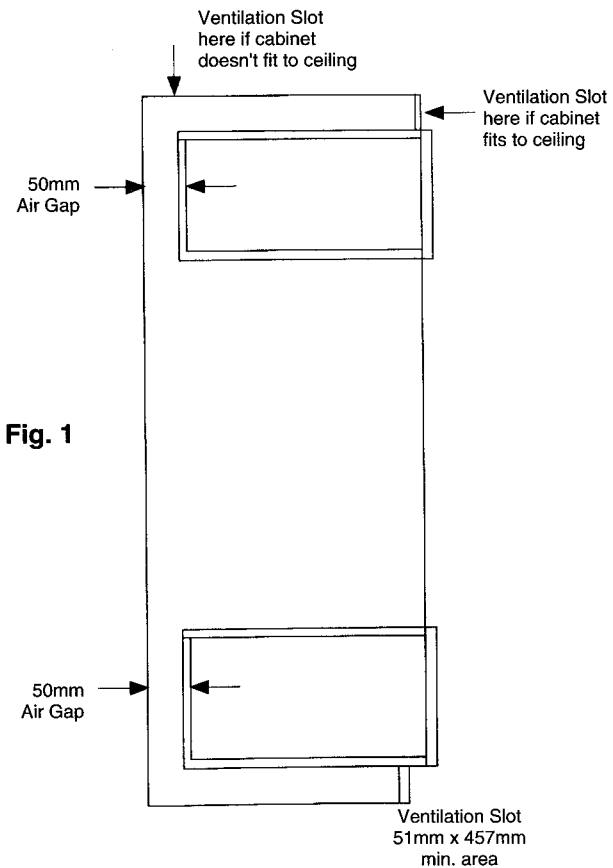
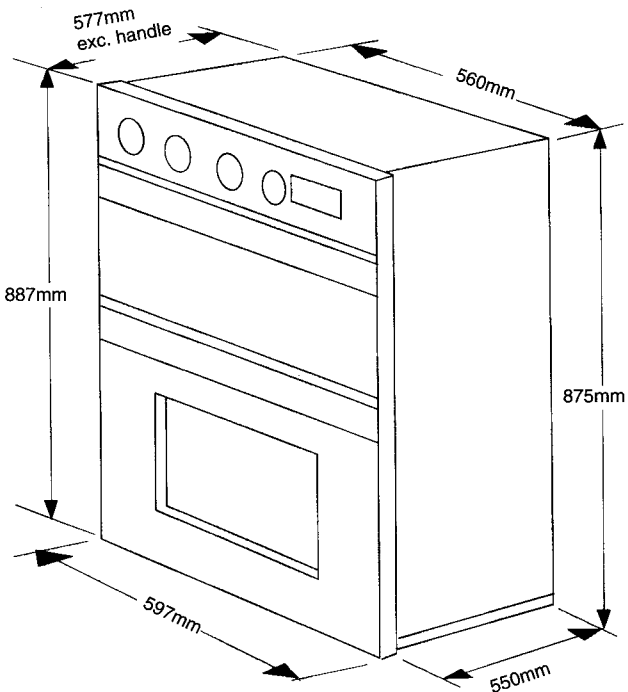

4. Return the inner door panel to the closed position as shown in Fig. 4.

**WARNING: CARE MUST BE TAKEN WHEN CLOSING THE DOOR INNER PANEL AS THE DOOR WILL ATTEMPT TO SNATCH SHUT, WITHOUT THE WEIGHT OF THE HANDLE/ OUTER GLASS ASSEMBLY AVOID TRAPPING YOUR FINGERS.**

Fig. 4

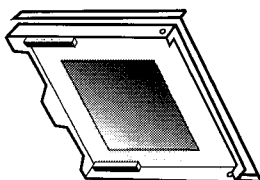

5. The inside of inner and outer door glass can now be cleaned using only warm soapy water and cloth **taking care not to damage the glass screen.**

6. Refit the handle/outer glass assembly by opening the oven door and hold taking care not to trap fingers, see Fig. 3. Hook the handle/outer glass assembly back into the rubber grommets at the bottom of inner door panel, see Fig. 3.

Fit the handle/outer glass assembly back in position at the top ensuring the fixing tags on the handle/outer glass assembly. Fit inside the door inner panel while still holding door together refit the two screws and washers, see Fig. 2.

**NEVER OPERATE THE OVENS WITHOUT THE OUTER GLASS PANELS CORRECTLY REFITTED.**

# Care and Cleaning

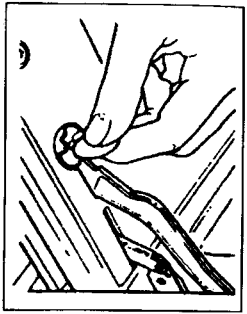

Fig. 8

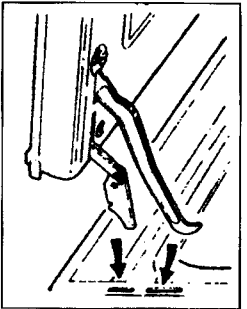

Fig. 9

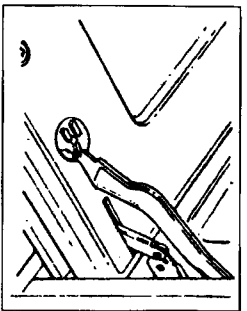

Fig. 10

**WARNING: ALWAYS SWITCH OFF YOUR APPLIANCE AT THE MAINS SUPPLY AND ALLOW TO COOL BEFORE CLEANING.**

## TO CLEAN INSIDE OF OUTER AND INNER GLASS PANELS

1. Position top or main oven door as shown in Fig. 1. **NOTE:** The door can be wedged open using a towel between the door and the side trim thus leaving your hands free.
2. Grip inner door panel and handle/outer glass assembly. Remove two screws and fibre washers (put to one side) as shown in Fig. 2
3. Pull handle/outer glass assembly at the top outwards while still holding the inner door panel and unhook handle/outer glass assembly at the bottom by lifting handle/outer glass assembly upwards as shown in Fig. 3. Take care not to dislodge rubber grommets in bottom of door.

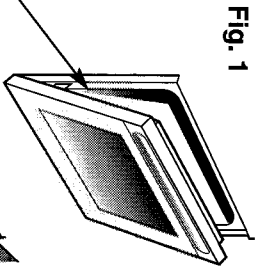

Fig. 1

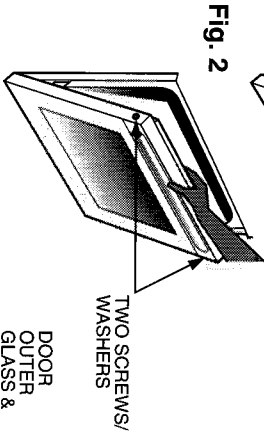

Fig. 2

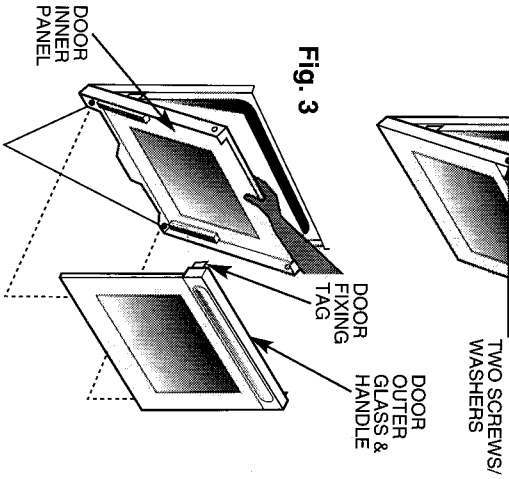

Fig. 3

Fig. 4

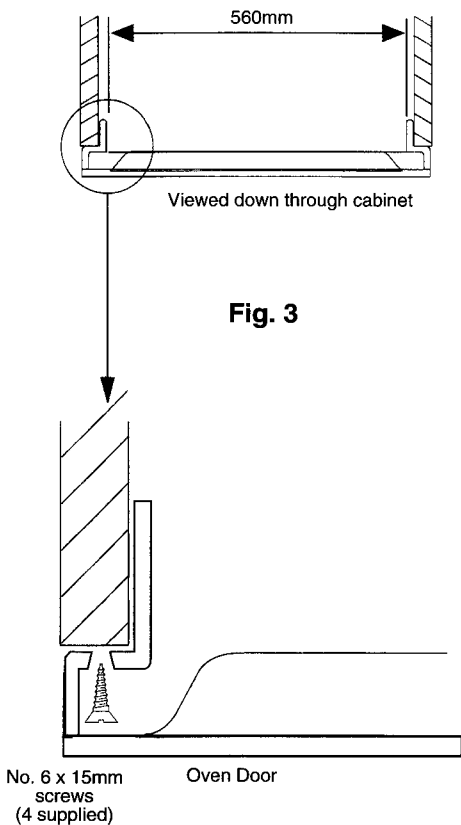
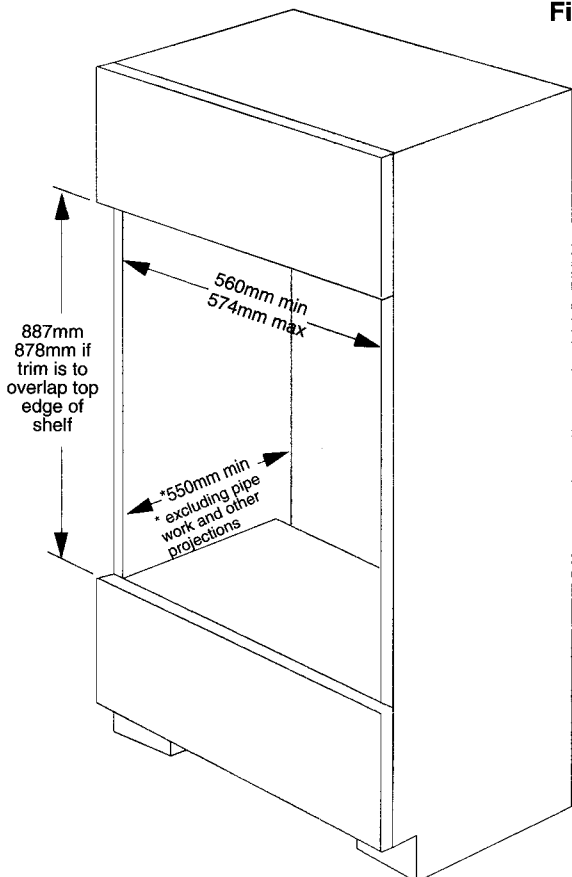

Fig. 3

## For Your Safety, Always ...

- Please read through before operating your appliance.**
- ALWAYS** Have your appliance installed by a competent engineer or electrical contractor.
  - ALWAYS** Ensure the appliance has been properly earthed.
  - ALWAYS** Remove all transportation packing from inside the oven/grill before switching on for the first time.
  - ALWAYS** Make sure you understand the controls prior to using them. (See pages 13 and 14)
  - ALWAYS** Keep children away from the oven at all times when oven/grilling as surfaces will get extremely hot.
  - ALWAYS** Remember that the oven and utensils will be very hot when in use.
  - ALWAYS** Take care when opening the door. Let the steam and hot air escape before removing the food.
  - ALWAYS** Use dry quality oven gloves for removing hot food utensils from the oven/grill.
  - ALWAYS** Select the correct shelf position before turning the oven or grill on.
  - ALWAYS** Turn off the electricity supply at the wall switch before cleaning.
  - ALWAYS** Ensure poultry is thoroughly defrosted before cooking well.
- ALWAYS** Check all controls on the appliance are switched off before retiring to bed or after use.
  - ALWAYS** Keep ventilation slots clear of obstructions.
  - ALWAYS** Reset the oven timer to Manual after completing an Automatic Cooking Programme.
  - ALWAYS** Take care on warm days when using the oven for delayed automatic cooking as certain foods can spoil.
  - ALWAYS** Use a thick cloth to protect your fingers when replacing the oven lamp.
  - ALWAYS** Refer servicing to a qualified appliance service engineer.
  - ALWAYS** Follow the guide lines for successful defrosting when using the fan only mode.

## Care and Cleaning

It should not normally be necessary to clean the Stay Clean panels with water. If the user feels it is desirable to do so, wash them down in warm, soapy water, followed by rinsing with clear water: **Do not use biological/enzyme washing powder, harsh abrasives or oven chemical cleaners of any kind.** Replacement oven liners are available should you require them, from your nearest Hotpoint Service Centre (see back page).

### Replacement of Oven Lamp

**WARNING: ISOLATE COOKER FROM SUPPLY BEFORE REPLACING LAMP.**

Open the oven door and remove the rod shelves. Grip the light glass dome, unscrew anti-clockwise and lift out. Reach into the aperture with fingers, and unscrew the faulty lamp anti-clockwise (25W 300°C SES) (Part No. 620601) which can be obtained from your nearest Hotpoint Service Centre. Fit replacement lamp, and refit dome. When screwing and unscrewing the faulty lamp use a thick cloth to protect your fingers should the lamp break.

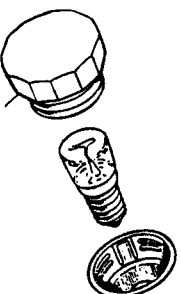

**WARNING: ISOLATE COOKER FROM SUPPLY BEFORE REMOVING DOOR.**

### Oven Door Removal Main (Lower) Oven

The door is removable to facilitate occasional cleaning of heavy soiling from the oven floor and from the door itself.

**Please note** that the door is heavy and care should be taken not to pinch your fingers during the removal and replacement.

To remove, open the door fully and, using a coin or screwdriver, turn the two discs clockwise to the position shown below (Fig. 8). Slightly close the door, unhook the lower hinge fingers, then pull the door away from the oven front frame.

To replace, insert the lower fingers and the hooked ends of the door stays, ensuring that the slots in the lower fingers engage with the front frame (Fig. 9). Fully open the door and turn the discs anti-clockwise to their normal working positions (Fig. 10).

Close the door - the hinge will now lock into position.



## Care and Cleaning

### TURN OFF THE MAIN SWITCH BEFORE CLEANING.

Before switching on again, ensure that all controls are in the **OFF** position.

#### Cleaning the Exterior

The outside of both ovens can be cleaned, when cooled down, using a cloth which has been rinsed in warm soapy water. The oven can then be wiped down with a clean dry cloth. **Never** use an abrasive powder as this will damage the surface.

#### Lower Oven

Remove the rod shelves and meat pan.

Use a fine steel wool soap pad to remove stubborn stains from the rod shelves, meat pan and the floor of the oven. Refer to the instruction opposite and on page 28 for cleaning the 'Stay Clean' panels.

**Do not use** aerosol cleaners on this oven as they could adversely affect the fan motor unit, and cannot be wiped off the fan blade.

#### Decorative Trims

It is advisable to clean the decorative trims regularly to prevent any build up of soiling which may detract from the appearance of the Cooker. The recommended method of cleaning is to wipe over the trims with a soft cloth wrung out in hot water, or mild non-abrasive cleaner. (If in doubt try the cleaner on a small area of trim which is not noticeable in normal use), then after wiping with a cloth wrung out in clear water, dry with a soft clean cloth.

**Do not use scouring pads or abrasive cleaners/powders which may scratch the surface. Under no circumstances should abrasive cleaning materials be used.**

#### Top Oven

Use a fine steel wool soap pad to remove stubborn stains from the rod shelves, grill pan and floor and roof of the oven.

#### Stay Clean Oven Liners

Refer to the instructions below for cleaning the following Stay Clean panels: **Oven** – side and rear panels.

#### How Stay Clean Oven Liners Work

The surfaces of the Stay Clean oven liners are treated on the mottled face with a special vitreous enamel which absorbs cooking soils. At temperatures of 220°C (425°F) or above, the special surface enables these soils to be slowly destroyed. The higher the temperature, the more effective it is. In most cases normal cooking operations at this temperature will permit this cleaning operation to proceed during cooking.

However if higher cooking temperatures are not used regularly, it may be necessary, in order to prevent heavy soiling, to run the oven without meat pan, at maximum setting for a couple of hours. This may be necessary once a month or every two or three months depending on the type and amount of oven cooking.

## For Your Safety, Never ...

**NEVER** Leave children playing unsupervised where the oven is installed and in use.

**NEVER** Attempt to grill with the grill/oven oven door closed.

**NEVER** Allow children to sit or stand on any part of the appliance.

**NEVER** Store food stuffs in the same cabinet as the oven.

**NEVER** Store items above an oven that children may attempt to reach.

**NEVER** Operate the oven with the inner glass panel removed.

**NEVER** Remove the oven shelves when the oven is hot.

**NEVER** Use water to extinguish oil or fat fires.

**NEVER** Use the oven/grill as a space heater.

**NEVER** Cover oven interior and shelves with aluminium foil.

**NEVER** Heat up unopened food containers as pressure can build up causing the container to burst.

**NEVER** Attempt to clean the oven until the mains supply has been switched off and the oven is cool.

**NEVER** Defrost the meat and poultry by warming through in the oven.

**NEVER** Store any aerosols/flammable liquids etc. in adjacent cabinetry.

**NEVER** Store anything which might catch fire in or near the oven.

**NEVER** Operate the grill when the ovens are set to cook automatically.

# The main parts of your Double Oven

**WARNING: DO NOT TOUCH THE GLASS DOORS WHEN THE OVEN IS IN USE AS THESE AREAS CAN BECOME HOT.**

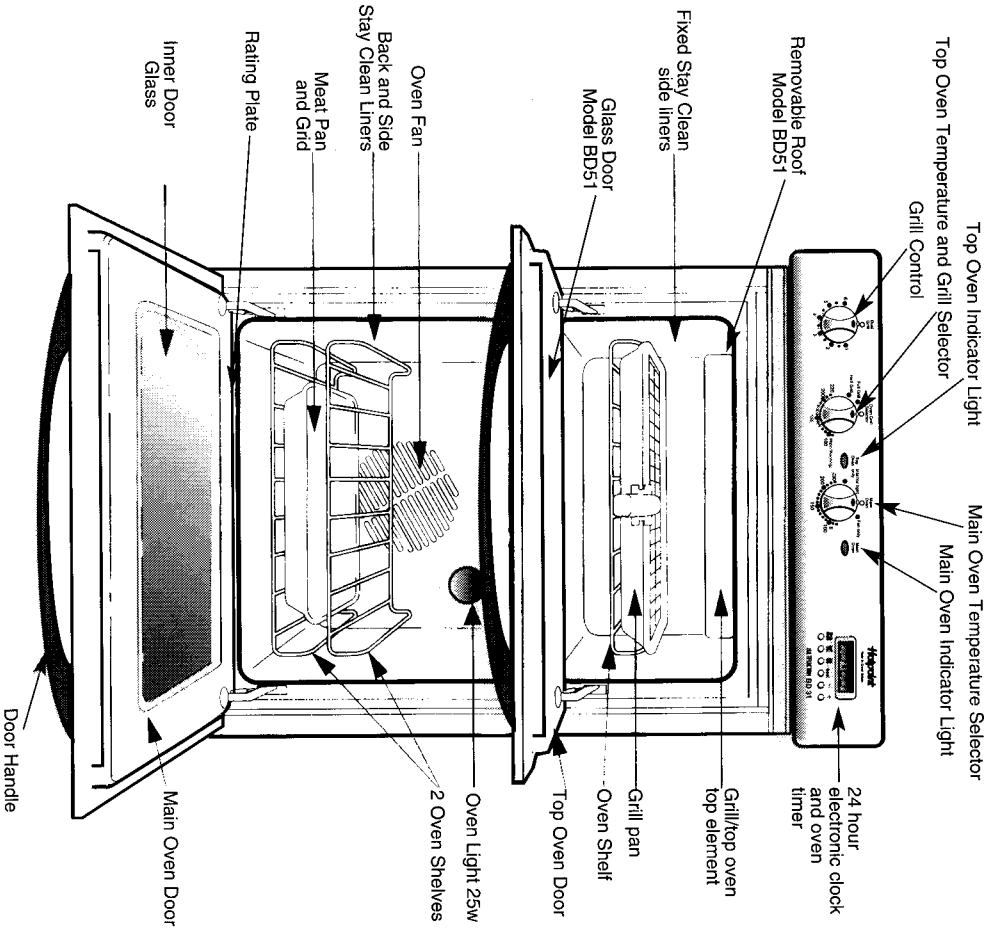

## Menus

### Fruity Chicken Casserole

- 4 chicken joints
- 1 red pepper, de-seeded and sliced
- 2 sticks of celery, chopped
- 1 large onion, peeled and sliced
- 100g (4 oz) mushrooms, sliced
- 400g (14 oz) can sliced peaches
- 3 tablespoons cornflour
- 1 tablespoon soya sauce
- 3 tablespoons malt vinegar
- Salt and pepper

1. Skin chicken joints and place in 2 litre (3 1/2 pint) casserole dish.
2. Fry pepper, onion, celery and mushrooms in oil.
3. Cover chicken with vegetables.
4. Drain fruit, reserving juice, and add to casserole.
5. Blend cornflour with soya sauce, vinegar and reserved juice, bring to the boil in a saucepan, add seasoning and pour into casserole dish.

### Rice Pudding

- 50g (2 oz) pudding rice
- Knob of butter
- 25g (1 oz) sugar
- 500ml (1 pt) milk, warmed
- Grated nutmeg

1. Place the washed rice into a greased dish and dot with butter.
2. Dissolve the sugar in the heated milk and pour over the rice.
3. Sprinkle grated nutmeg over the top.
4. Leave uncovered, place in oven.

# Menus

## Menu 5 continued

- 225g (8 oz) slightly stale bread
- 250ml (1/2 pint) milk
- 2 eggs
- 1 tablespoon brandy, optional
- 175g (6 oz) mixed dried fruit
- 40g (1 1/2 oz) demerara sugar
- 50g (2 oz) melted butter
- 1 teaspoon mixed spice
- Finely grated rind of 1 lemon
- Grated nutmeg
- Caster sugar

## Spiced Bread Pudding

1. Grease shallow ovenproof dish. Line base with greased greaseproof paper.
2. Cut bread into very small pieces.
3. Bring milk to boil and pour over bread. Add pinch of salt, allow to stand for about 20 mins or until pulped.
4. Lightly beat eggs and stir into bread mixture with brandy, dried fruit, sugar, butter, mixed spice and lemon rind. Mix well together.
5. Turn mixture into prepared dish. Sprinkle with little nutmeg and caster sugar.
6. Place in oven.

## Ratatouille

- 375g (12 oz) aubergines
- Salt
- 225g (8 oz) onions, peeled and sliced
- 1-2 cloves of garlic, crushed
- 2 tablespoons vegetable oil
- 375g (12 oz) tomatoes, skinned and roughly chopped
- 375g (12 oz) courgettes, sliced
- 375g (12 oz) red peppers, de-seeded and sliced
- Bunch of fresh herbs
- Salt and pepper
- Chopped parsley

1. Slice aubergines and sprinkle with salt, leave for 30 mins, pat dry.
2. Cook onions gently with garlic, in oil until soft.
3. Add remaining ingredients, and heat thoroughly.
4. Place in casserole dish.
5. Cover tightly with foil and lid.
6. Place in oven.

## Menu 6

- Tomato Soup**
- Fruity Chicken Casserole**
- Rice Pudding**

- 1 medium sized onion, peeled and chopped
- 15ml (1 tbs) vegetable oil
- 675g (1 1/2 lb) tomatoes, roughly chopped
- 500ml (1 pint) vegetable stock
- Salt and pepper
- 5ml (1 level tsp) caster sugar

## Tomato Soup

1. Fry onion gently in oil until soft.
2. Add tomatoes, stock, seasoning and bring to boil.
3. Place in casserole dish cover with foil and lid and place in oven.
4. Before serving, sieve soup.
5. Reheat, adjust seasoning if necessary and stir in sugar.
6. For cream of tomato soup stir in 50 ml (2floz) cream and reheat soup very gently without boiling. Garnish with a swirl of cream.

Cook on 'Eco' setting for 7 hrs.

## Method

# The Cooking Systems in your Double Oven

Your new oven is equipped with three different cooking systems:

1. **Conventional Heating (Top Oven)** - with upper and lower heat. This system is particularly suitable for roasting and baking on one shelf only.

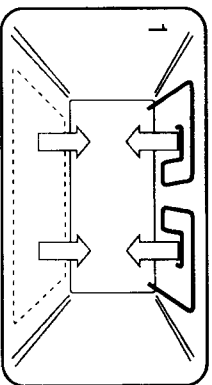

2. **Grilling (Top Oven)** - Has a full width, fully controllable grill. The grill also has an economy setting which enables you to use just the left section.

**NOTE: The oven door should be open when grilling.**  
(See page 18.)

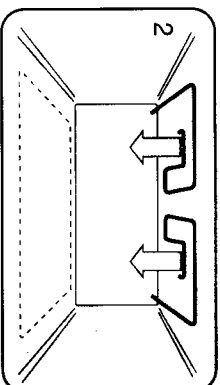

3. **Fan Cooking (Lower Oven)** - the fan oven operates by constantly blowing heated air from an element wrapped around the fan into the oven. This gives improved efficiency and, in general, enables the use of lower temperatures for cooking. It also means that there is less need to be particular about shelf positions and that you can bake at more than one level simultaneously (Batch Baking).

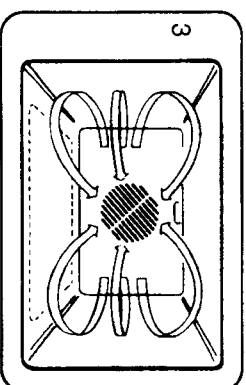

It should be noted that at the end of a cooking period there may be a momentary puff of steam when the oven door is opened. This will disperse in a few seconds and is a perfectly normal characteristic of an oven with a good door seal.

## Before Using the Oven for the First Time

### Make sure the electricity supply is switched ON.

Please note that when the double oven is used for the first time a slight odour may be emitted due to the 'burring off' of any temporary finish on oven fittings and elements and the removal of moisture absorbed by the lagging. The odour will cease after a short period of use.

To remove the 'new smell', heat up the empty oven for 30 minutes keeping the door closed. Ensure

that the room is well ventilated (eg, open a window or door) and that persons who may be sensitive to the odour avoid any fumes. It is suggested that any pets be removed from the room until the new smell has ceased. Turn the selector switch to fan oven function, then turn oven thermostat to MAX. Also turn Top Oven/Grill selector to MAX. The oven temperature thermostat lights will come on as well as the interior light, oven fan, control panel illumination, and cooling fan.

## Temperature Conversion Scale

The chart below gives details of comparisons of oven settings for gas conventional ovens and fan oven in degrees °F and °C

GAS MARK	CONVENTIONAL OVEN		FAN OVEN
	°F	°C	°C
1/2	250	120	100
1	275	140	120
2	300	150	130
3	325	160	140
4	350	180	160
5	375	190	170
6	400	200	180
7	425	220	20
8	450	230	210
9	475	240	220

## Menus

### 4 Large potatoes

#### Jacket Potatoes

1. Scrub the potatoes, prick well.
2. Wrap each potato in a piece of cooking foil.

#### Pear Pudding

- 50g (2 oz) butter } Melted  
 50g (2 oz) dark brown sugar } together  
 100g (4 oz) margarine  
 100g (4 oz) caster sugar  
 2 size 4 eggs  
 100g (4 oz) self raising flour, sieved  
 1/4 teaspoon almond essence  
 3 pears, peeled, cored and cut into 4

1. Coat base of soufflé dish with melted butter and sugar.
2. Cream together margarine and sugar until light and fluffy.
3. Beat in each egg, fold in flour, and stir in almond essence.
4. Place prepared pear slices in base of dish then cover with cake mixture.
5. Cover dish tightly with foil.
6. Place in oven.

### Menu 5

#### Method

Cook on 'Eco,' setting for 7 hrs

- Rich Onion Soup
- Honey Roast Ham
- Ratatouille
- Bread Pudding

#### Rich Onion Soup

- 450g (1 lb) onions, peeled and thinly sliced
- 25g (1 oz) butter
- 1 tablespoon vegetable oil
- 1 teaspoon salt
- 1/2 teaspoon brown sugar
- 40g (1 1/2 oz) plain flour
- 750ml (1 1/2 pint) brown stock
- 125ml (1/4 pint) stout or brown ale

1. Gently cook onions in butter and oil in large saucepan for 5 minutes.
2. Add salt and sugar and cook for 2 minutes.
3. Remove from heat and stir in flour, stock and beer.
4. Bring to boil. Place in casserole dish.
5. Cover tightly with foil and lid.
6. Place in oven.

#### Honey Roast Ham

- 2kg (4 1/2 lb) joint middle cut gammon
- Sauce:
  - 2 tablespoons honey
  - 2 tablespoons sherry
  - 1 tablespoons demerara sugar

1. Soak gammon in cold water overnight. Drain and dry.
2. Coat with sauce, wrap in foil.
3. Place in tin.
4. Cook on 180°C for 30 minutes. Add rest of meal to oven and set to 'Eco' setting for 7 hrs.

# Menus

## Menu 3 continued

- 10 oz (275g) long grain rice
- 3 tablespoons (45ml) oil
- 1 1/4pt (625ml) water

## Long Grain Rice

1. Wash the rice.
2. Fry the rice in oil until lightly browned.
3. Boil the water, add salt and place with rice in casserole dish.
4. Cover dish tightly with foil and lid.
5. Place in oven.

## Fruit Crumble

- 675g (1 1/2 lb) Fruit, prepared
  - 75g (3 oz) Caster sugar
  - 175g (6 oz) Plain flour
  - 75g (3 oz) Butter
  - 75g (3 oz) demerara sugar
1. Place prepared fruit and sugar in dish.
  2. Rub butter into flour until it resembles fine breadcrumbs.
  3. Stir in demerara sugar and mix well.
  4. Sprinkle over fruit.
  5. Place in oven.

## Menu 4

- Salmon Pate
- Roast Lamb
- Jacket Potatoes
- Pear Pudding

## Salmon Pate

- 450g (1 lb) cooked, or canned salmon, pink or red
- 4 x 2.5 cm (1") thick slices of white bread from large loaf
- 250ml (1/2 pint) milk
- 25g (1 oz) butter, softened
- 1 egg yolk
- 2 tablespoons chopped parsley
- Juice of 1/2 lemon
- Salt and Pepper

## Method

Cook on 'Eco' setting for 7 hrs.

1. If using canned salmon, drain. Flake salmon into bowl.
2. Break bread into small pieces and soak in milk for 5-10 mins, or until soft. Stir into fish
3. Add softened butter, egg yolk, parsley, lemon juice and seasoning. Beat together till thoroughly mixed.
4. Turn mixture into 500ml (1 pint) greased overware dish and cover with foil.
5. Place dish in larger dish containing 2.5 cm (1") of hot water.
6. Cover completely with foil. Place in oven, carefully.

## Roast Lamb

- 1.25 kg (2 1/2 lb) Leg of Lamb
  - 1 teaspoon rosemary
  - 1 tablespoon parsley, chopped
  - Salt and pepper
  - Bay leaf
- } Mixed together
1. Wipe meat. Place in piece of foil.
  2. Season well with mixture and wrap tightly in foil.
  3. Place on rack in dish.
  4. Cook in oven at 170°C for 30 minutes before setting to 'Eco'.

# The Controls

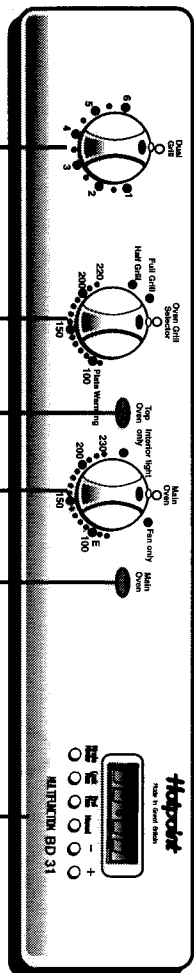

## IMPORTANT

Before using your oven in the ordinary way, **ALWAYS** make sure that the timer has been set to **MANUAL** operation. Unless this is done, the oven cannot heat up. Before seeking assistance, make sure you have done this.

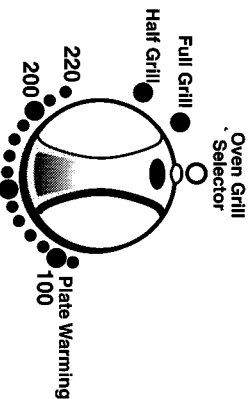

## Top Oven Control

To use the Top Oven, you must turn the Top Oven Temperature Control clockwise to the required temperature. The red Thermostat Light will immediately come on and remain on until the oven reaches the required temperature. It then cycles off and on during cooking as the thermostat maintains the oven temperature. If the thermostat light does not come on when the Top Oven is turned on, check that the oven is set to (Manual) (see page 15). Always remember to keep the oven door closed. After use always set the oven control back to 'O' (Off).

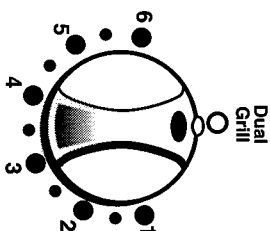

## Grill Control

Keep young children away from the appliance when the grill is in use as the surfaces get extremely hot. Grilling should not be undertaken with the Grill/Top Oven Door closed.

Turn the top oven control clockwise past the temperature settings to the half grill or full grill settings, depending upon which you require. To set the power of the grill turn the Grill Control clockwise to any setting 1-6. After use always turn the top oven and grill controls anti-clockwise back to 'O' (Off).

## Menus

### Lower Oven Controls

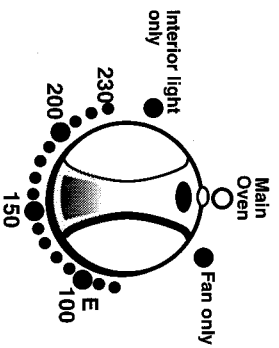

Turn the lower oven control clockwise to the required temperature.

The thermostat light will immediately come on and remain on until the oven reaches the selected temperature. The light will then cycle off and on during cooking as the lower oven maintains the temperature.

#### **Fan Only** (see page 24).

To select 'DEFROST' turn the lower oven control clockwise to the 'FAN ONLY' setting.

After use, always turn the lower oven control anti-clockwise back to 'O' (Off).

#### **Eco Setting**

The lower oven has an economy setting to select turn lower oven control to the Eco setting. See Eco recipe book provided for foods that can be cooked at this setting.

**NOTE:** Eco cooking can be cooked automatically (see pages 15-17).

#### Braised Topside au Poivre

- 450g (1 lb) Topside of beef, cut into 4 slices  
1 tablespoon black peppercorns, crushed  
Salt  
25g (1 oz) butter  
2 tablespoons vegetable oil  
4 small courgettes, thickly sliced  
4 tomatoes, sliced  
125ml (1/4 pint) red wine
1. Sprinkle beef with peppercorns and salt.
  2. Heat butter and oil in frying pan, cook half the courgettes and tomatoes, place in bottom of casserole dish.
  3. Fry meat on both sides and place on top of vegetables, then cook remaining vegetables and place on top of meat in casserole dish.
  4. Add red wine to pan and bring to the boil. Pour into casserole dish.
  5. Cover dish with foil and fit lid tightly.
  6. Place in oven.

#### Rhubarb and Raspberry Crunch Layer

- 100g (4 oz) butter, melted  
100g (4 oz) rolled oats  
100g (4 oz) digestive or ginger biscuits coarsely crushed  
50g (2 oz) mixed chopped nuts  
175g (6 oz) demerara sugar, divided in half  
Good pinch of cinnamon  
450g (1 lb) rhubarb, cut into 2.5cm (1") lengths  
225g (8 oz) frozen raspberries
1. Mix together butter, oats, crushed biscuits, nuts, half sugar and cinnamon.
  2. In another bowl mix remaining sugar and fruits together.
  3. Place half fruit in bottom of a 1.1 litre (2 pint) greased ovenproof dish. Sprinkle with half biscuit mixture.
  4. Repeat layers.
  5. Place in oven.

#### Menu 3

##### **Chilli Con Carne**

##### **Rice**

##### **Fruit Crumble**

- 675g (1 1/2 lb) minced beef  
15ml (1 tbsp) vegetable oil  
1 large onion, skinned and chopped  
1/2 green pepper, seeded and chopped  
2 x 425g (15 oz) can tomatoes, chopped  
Salt and Pepper  
1 tablespoon chilli powder  
1 teaspoon brown sugar  
2 tablespoons tomato puree  
425g (15 oz) can red kidney beans, blended together

##### Chilli Con Carne

1. Fry minced beef in oil until lightly browned, add onion and pepper and fry for 5 mins, until soft.
2. Blend together chilli powder, brown sugar and tomato puree.
3. Stir in tomatoes, chilli paste and seasoning. Bring to boil.
4. Place in casserole dish.
5. Cover tightly with foil and lid.
6. Place in oven.

#### Method

Cook on 'Eco' setting for 7 hrs.

# Menus

## Menu 1 continued

- 225g (8 oz) onion, peeled and chopped
- 2 tablespoons vegetable oil
- 450g (1 lb) red cabbage, finely shred
- 225g (8 oz) cooking apple, peeled, cored and diced
- 225g (8 oz) pear, peeled, cored and diced
- 3 tablespoons brown sugar
- 1/2 teaspoon nutmeg
- Salt and Pepper
- 3 tablespoons cider vinegar
- Juice of 1 orange

## Braised Red Cabbage

1. Place onion and oil in pan and cook for 3 minutes.
2. Add cabbage, apple and pear and cook for 3-4 minutes. Place in casserole dish.
3. Add remaining ingredients to pan and heat to boiling. Pour over vegetables.
4. Cover dish tightly with foil and lid.
5. Place in oven.

## Summer Pudding

- 8-10 slices of bread, crusts removed
- 50g (2 oz) butter melted
- 50g (2 oz) demerara sugar
- 375g (12 oz) prepared fruit, eg. strawberries, raspberries etc.
- 50g (2 oz) caster sugar
- 2 tablespoons water

1. Grease a basin or soufflé dish with butter and sprinkle with sugar.
2. Line with buttered and sugared bread, placing the buttered side towards the out side of the basin.
3. Pack firmly with fruit and add sugar and water.
4. Cover with buttered, sugared bread.
5. Cover dish with foil.
6. Place in oven.

## Menu 2

- Spring Vegetable Soup**
- Braised Topside au Poivre**
- Rhubarb and Raspberry Crunch Layer**

## Spring Vegetable Soup

- 3 medium sized carrots, peeled and sliced
- 2 medium sized onions, peeled and diced
- 2 sticks celery, cut into 1" pieces
- 15g (1/2 oz) butter
- 58g (2 1/4 oz) can tomato puree
- 2 vegetable stock cubes
- Salt and Pepper
- 50g (2 oz) sliced green beans
- 100g (4 oz) shredded white cabbage
- 1 teaspoon cornflour, blended with a little cold water

## Method

Cook on 'Eco' setting for 7 hrs.

1. Melt butter in pan, add carrots, onions and celery and fry gently for 3-4 minutes.
2. Stir in tomato puree, crumbled stock cubes, 1 litre (1 3/4 pints) water and seasoning.
3. Bring to the boil, transfer to large casserole dish.
4. Add remaining ingredients to dish, cover tightly with foil and lid.
5. Place in oven.

# The Automatic Oven Timer

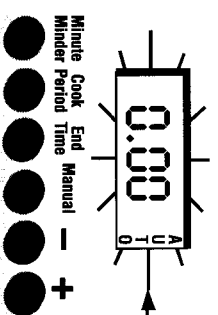

## To Set Time of Day

- Step 1** Make sure all oven controls are turned off.
- Step 2** Check the electricity supply to the cooker is turned on.
- Step 3** When switched on the display will show 0.00 and Auto flashing intermittently.

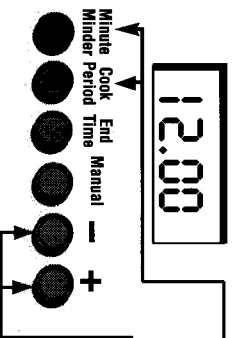

- Step 4** Press and hold the "Minute Minder" and "Cook Period" button together, display shows 12.00.

At the same time press either the "+" or "-" buttons to set the correct time of day.

**THE TIME OF DAY IS NOW SET.**

## To Set Timer To Switch OFF Automatically

**This allows you to cook immediately for a chosen period before the oven switches Off Automatically**

- Step 1** Ensure the time of day is set correctly.
- Step 2** Place food onto the correct shelf position in the oven.
- Step 3** Turn the oven control to the required temperature (Oven should now be operating).

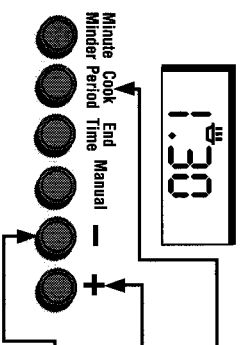

- Step 4** Press and release the cook period button the display will read 0.00 with the cookpot lit.

Within 2 seconds press and hold the "+" button until the required cooking period is set. (Adjustment can be made by pressing the "-" button).



The timer display will revert to the time of day with the Auto symbol and Cookpot lit.

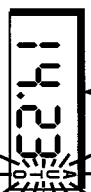

At the end of the cooking period the Auto symbol will Flash and an intermittent bleeping sound will be heard.  
 - This will continue for approximately 2 minutes unless the timer is reset within this period (See Step 6).

**The oven will now no longer operate until the timer has been reset.**  
 (See Steps 5 & 6 on next page)

## To Set Timer To Switch OFF Automatically (cont.)

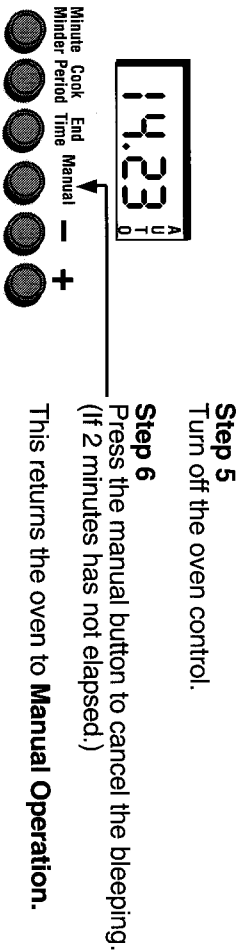

## To Set Timer To Switch ON and OFF Automatically

**This allows you to cook at a specified time for a chosen period before the oven switches Off Automatically.**

- Step 1** Ensure the time of day is set correctly.  
**Step 2** Place food onto the correct shelf position in the oven.

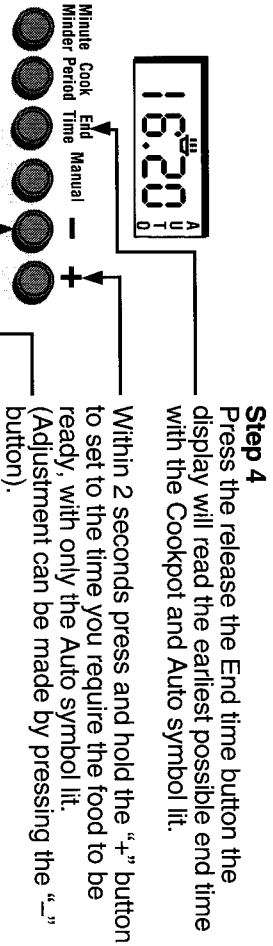
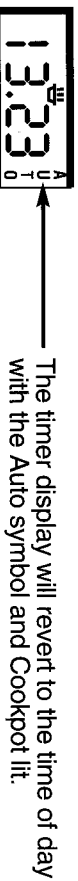
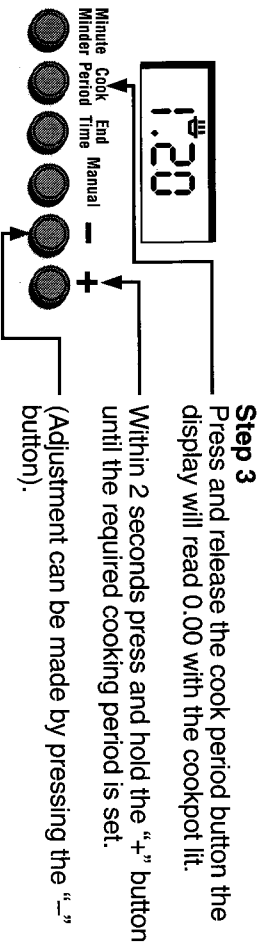

**Step 5**  
Turn the oven control to the required temperature. *The oven will now switch on later in the day for the cooking period required and will cut off automatically at the end time setting.*  
At the end of the cooking period the Auto symbol will flash and an intermittent bleeping sound will be heard. This will continue for approximately 2 minutes unless the timer is reset within the period. (See Step 7 on next page).

## Menus

### Menu 1

**Leek and Potato Soup**  
**Stuffed Peppers**  
**Braised Red Cabbage**  
**Summer Pudding**

### Leek and Potato Soup

450g (1 lb) Leeks, trimmed, washed and cut into rings  
 450g (1 lb) Potatoes, peeled, washed and thinly sliced  
 2 tablespoons vegetable oil  
 500ml (1 pint) hot vegetable stock  
 Salt and Pepper  
 250ml (1/2 pint) single cream  
 250ml (1/2 pint) milk

### Method

Cook on a 'Eco' setting for 6 hrs.

1. Prepare leeks and potatoes.
2. Fry leeks in oil until soft. Add potato slices and cook for 3 minutes.
3. Add stock and seasoning, bring to boil.
4. Transfer to large casserole dish, cover with foil and fit lid tightly. Place in oven.
5. At end of cooking, puree until thick and smooth.
6. Stir in cream and milk and re-heat gently, do not boil.

### Stuffed Peppers

4 Peppers, washed  
 1 tablespoon vegetable oil  
 1 small onion, peeled and diced  
 4 mushrooms, wiped and sliced  
 1 courgette, sliced  
 2 tomatoes, peeled and chopped  
 50g (2 oz) long grain rice, cooked  
 Salt and Pepper

1. Cut tops of peppers, deseed and carefully remove stalks from tops.
2. Blanch in boiling water for 2 minutes, drain.
3. Heat oil in pan, cook onion until soft.
4. Add mushrooms, courgette and tomatoes, cook for 3-4 minutes.
5. Add rice and seasoning, cook for 2 minutes.
6. Place blanched peppers in casserole dish, divide vegetable mixture equally into the peppers. Put lids on peppers.
7. Cover dish tightly with foil and the lid.
8. Place in oven.



## Using The 'Eco' Setting

### Points to bear in mind when preparing food:-

1. Make sure all dishes will fit into the oven before preparing the food.
2. All dishes cooked by the 'Eco' setting should be cooked for a minimum of 6 hours. They will 'hold' at this setting for a further hour but marked deterioration in appearance will be noticed in some cases.
3. Joints of meat and poultry should be cooked at fan oven 170°C for 30 mins before turning to the Eco setting.
4. Meat over 2.7 Kg. (6 lbs) and poultry over 2 Kg. (4 lbs. 8 oz) are unsuitable for the Eco setting.
5. Always stand covered joints on a rack over the meat tin, to allow good air circulation.
6. Pork joints can only be cooked, if by testing with a meat thermometer and internal temperature of at least 88°C is reached.
7. This method is unsuitable for stuffed meat and poultry.
8. Always bring soups, casseroles and liquids to the boil before putting in the oven.
9. When casseroles are used, cover the food first with foil and then the lid to prevent loss of moisture.
10. Always thaw frozen food completely before cooking.
11. Root vegetables will cook better if cut into small even sized pieces.
12. Always adjust the seasoning and thickenings at the end of the cooking time.
13. Egg and fish dishes need only 1-5 hours cooking and should be included in day cooking sessions, where they can be observed from time to time.
14. Dried red kidney beans must be boiled for a minimum of ten minutes after soaking, before inclusion in any dish.

### Storage and Re-heating of Food

1. If food is to be frozen or not served immediately, cool it in a clean container as quickly as possible.
2. Thaw frozen food completely in the refrigerator before re-heating.
3. Re-heat food thoroughly and quickly either on the hotplate or in the fan oven, 170°C and then serve immediately.
4. Only re-heat food once.

## To Set Timer To Switch ON and OFF Automatically (cont.)

The oven will no longer operate until the timer has been reset to manual operation.

### Step 6

Turn off the oven control.

### Step 7

Press the manual button to cancel the beeping sound. (If 2 minutes has not elapsed.)

This returns the oven to **Manual Operation**.



### Other Notes On Timer Operation

1. When cooking Automatically the cook period can be checked at any time simply by pressing the cook period button.
2. When cooking Automatically the End time can be checked at any time by simply pressing the stop time button. (This also can be altered at any time by following step 4 above.)
3. Having set a cooking period and End time an electronic device stores the information. The device within the timer will switch the oven on at the required start time.
4. If a mistake is made and is not readily rectified alter the cook period to show **0:00** (as per Step 3 above) then press the Manual button (see Step 7 above) and start the sequence again.
5. After an Automatic sequence the beeping sound could also be switched off by pressing any of the three buttons  (Minute Minder, Cook Period, End Time).

However the cooker cannot be re-used until the timer has been set to manual operation, this is achieved by pressing the manual button (see Step 7 above).

6. If at any time the display shows three flashing zero's **0:00** it is likely that the electricity supply to the oven has been interrupted. Reset the timer to the correct time of day. *Food in the oven may therefore not have been cooked, before serving check food is thoroughly cooked.*

7. To give yourself more time to set each function press and hold the required function button and at the same time press "+" or "-" button.

**NOTE:** Between the hours of 10.00p.m. and 6.00a.m. the intensity of the display reduces.

## To Set The Minute Minder



**Step 1**  
Ensure the time of day is set correctly.

**Step 2**  
Press and release the Minute Minder Button. Within 5 seconds press and hold the "+" button until the required time is set.

This can be adjusted by pressing the "-" button.

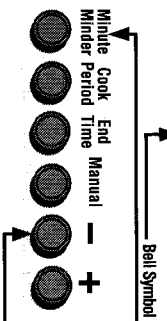

The timer will then revert back to the time of day.  
At the end of the set time a beeping sound will be heard and the bell symbol will flash.

This can be cancelled by pressing the Minute Minder button.

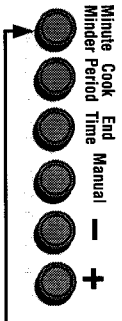

**NOTE:** If necessary the Minute Minder can be cancelled before the tone sounds by pressing the Minute Minder button and then pressing the "-" button until 0.00 appears in the display window.

## The 'Eco' Setting 90°C

This is used for slow cooking, keeping food warm and warming plates for short periods. Extra care must be taken when warming bone china.

### Some advantages of slow cooking are:

The oven stays cleaner because there is less splashing.

Timing of food is not as critical, so there is less fear of overcooking.

Inexpensive cuts of meat are tenderised.

Fully loading the oven can be very economical.

Cooking times can be extended in some cases by up to 2hrs.

The kitchen stays cooler.

Bearing in mind these advantages, it makes sense to cook larger quantities of food than required and store them in a freezer to be used cold or for re-heating. It is important to follow the guidelines given for preparing food using the 'Eco' setting.

# Fan Only

## Defrosting Frozen Meat and Poultry

Joints of meat and whole birds should be defrosted slowly, preferably in a refrigerator (allowing 5-6 hours per lb), or at room temperature (allowing 2-3 hours per lb).

Frozen meat or poultry must be completely defrosted before placing in the oven.

The Main Oven has a Fan Only position. Set lower oven control to Fan Only function - this can be used to assist defrosting by circulating the air around the food, time to defrost will depend on type and size of the food and the room temperature.

### DO NOT turn the temperature control on.

### DO NOT defrost meat and poultry by warming the food through.

Foods ideally suited for fan defrosting (without heat) are those which are normally served cold, e.g. cream/cream cakes, butter cream filled cakes, gateaux, cheese cakes, iced cakes, quiches, pastries, biscuits, bread, croissants, fruit and many delicate frozen foods.

If fish, meat and poultry are to be 'fan only' defrosted as selected on the lower oven control (without heat), then where possible the items of food should be small and thin, eg. fish fillets, peeled shrimp, cubed or ground meat, sliced meat, thin chops, steaks or liver.

The items should be placed so the maximum amount of surface area is exposed to the circulating air and turned regularly to ensure even defrosting.

Fan defrosting without heat is only suitable for meat and poultry joints up to a maximum weight of 4 lb.

### It is important to wash both roast and cooking utensils immediately after defrosting.

It is vitally important to strictly adhere to the basic principles of food handling and hygiene to prevent the possibility of bacterial growth.

### Defrosting

Food can be defrosted in the main oven as though it was thawing at room temperature, with the advantage that it is much quicker. The selector switch should be set at Fan Only and the food for defrosting placed on a tray.

### No heat is required for defrosting.

## Automatic Cooking Never operate the grill when the ovens are set to cook automatically.

### Hints on Automatic Cooking

1. Select foods which will take the same time to cook and require approximately the same temperature.
2. Set the oven timer so that the food has just finished or about to finish cooking on your return to the oven. This will ensure the food has not cooled down and does not require reheating before serving.
3. Food should be as cold as possible when it goes into the oven, ideally straight from the refrigerator. Frozen meat and poultry should be thawed thoroughly before it is put into the oven.
4. We advise that warm food should never be placed in the oven if there is to be a delay period. Stews prepared by frying the meat and vegetables should be cooked as soon as possible.
5. We advise dishes containing left over cooked poultry or meat, for example shepherd's pie, should not be cooked automatically if there is to be a delay period.
6. Stews and joints should be cooked by the long slow method, so that the delay period is kept to a minimum.
7. On warm days, to prevent harmful bacteria growth in certain foods (ie: poultry, joints, etc) the delayed start should be kept to a minimum.
8. Wine or beer may ferment and cream may curdle during the delay period, so it is best to add these ingredients just before serving.
9. Foods which discolour should be protected by coating in fat or tossing in water to which lemon juice has been added, prior to placing food in the oven.
10. Dishes containing liquid should not be filled too full to prevent boiling over.
11. Foods should be well sealed (but not airtight) in a container to prevent the loss of liquid during cooking. Aluminium foil gives a good seal.
12. Ensure food is cooked thoroughly before serving.

## Grilling in the Top Oven

Keep young children away from the appliance when the grill is in use as the surfaces get extremely hot.

**Grilling should NOT be undertaken with the Grill/Top Oven door closed. (See below)**

**Never:** Line the grill pan with aluminium foil.

The grill control provides variable heat control of the grill element and will only operate once the oven control has been set to a grill position (fully clockwise).

The grill regulator is designed to provide variable heat control of either the twin grill elements on together or the single left-hand grill element only, depending on which mode you select:

To select twin grill, first turn the Top Oven/Grill Selector clockwise to Full Grill.

The heat can now be adjusted by setting the grill regulator.

To select single grill turn the Top Oven/Grill Selector clockwise to Half Grill.

Food which requires browning only should be placed under the hot grill directly on the shelf in the first or second runner from the bottom of the oven, according to the depth of the dish.

**Care should be taken when removing the grill pan during or directly after use.**

After use, always return both controls anticlockwise to the **OFF** position.

**NOTE: The grill pan must be cleaned after every use. Excess fat build up in the bottom of the pan could cause a fire hazard.**

The heat can now be adjusted by setting the grill regulator.

**Please note that the Grill will not operate unless the Top Oven/Grill Selector is in a grill position.**

**After use, turn both controls ANTI-CLOCKWISE to their off positions.**

### Grill Procedure

Ensure oven timer is set to Manual. Pre-heat the grill at setting 6 for approximately 5 minutes.

When toasting/grilling, the rod shelf is placed in either the first or second runner position from base.

The grill pan is placed on the shelf and pushed back as far as possible to correctly position it under the grill element. Leave the control at 6 for toast, and for sealing and fast cooking of foods. For thicker foods requiring longer cooking, turn the switch to a lower setting after the initial sealing on both sides at 6.

The thicker the food, the lower the control should be set.

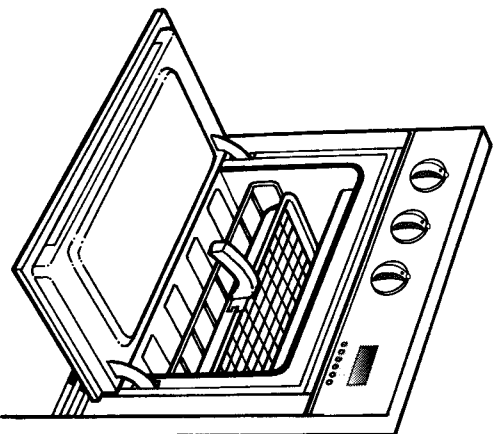

## Cooking in the Lower Oven – Fan Cooking

### Operation

Turn the Lower Oven Control to the required temperature. The oven light will come on. The oven thermostat light will immediately come on and remain on until the oven reaches the set temperature. This light will then automatically turn off and on during cooking and the oven will operate whilst the oven is switched on and door closed.

**Note:** If the thermostat light does not come on when the lower oven control is turned, check that the Timer is in Manual Operation.

Since a fan oven heats up more quickly, and generally cooks food at a lower temperature than a conventional oven, pre-heating the oven is often unnecessary. However, foods such as bread, scones, Yorkshire pudding, do prefer to be placed in a pre-heated oven.

The charts on pages 21 and 22 are a guide only, giving approximate cooking temperatures and times. To suit personal taste and requirements, it may be necessary to increase or decrease temperatures by 10°C.

### Oven Positions

Since the distribution of heat in fan ovens is very even, most foods will cook satisfactorily on any shelf position, but the shelves should be evenly spaced.

To ensure even circulation do not use meat pans larger than 390 x 300mm (15in x 12in) and baking trays no larger than 330 x 255 mm (13in x 10in), these should be positioned centrally on the oven shelf.

Food should not be placed directly on the floor of the oven.

Never use more than 3 shelves in the oven as air circulation will be seriously restricted.

To avoid unnecessary cleaning, rod shelves which are not in use should be removed from the oven.

Allow extra cooking time when batch baking eg. 6 x 150 mm (6 in) Victoria sandwich tins.

### Temperature and Time

When all three shelves are used to cook large quantities of food for home freezing or parties, it may be necessary to increase the cooking times given in the charts on pages 21 and 22 by a few minutes.

**NB.** Recipes in cookery books give times and temperatures for cooking in conventional ovens.

To adapt for fan oven refer to the temperature chart on page 12.

### Oven Interior Light Lower (Main) Oven

To select oven light only, turn the lower oven control to the oven light function. The oven light will come on.

### Cooling Fan

A cooling fan is incorporated to protect the oven controls and oven housing from overheating. It will operate when any of the oven controls are switched **On** and may continue for a time after all controls are **Off**. A gentle flow of air will be projected from below the control panel.

If the controls become too hot, a cut-out comes into operation and the Top Oven/Grill will switch off (cut-out thermostat behind the controls) and only the oven clock will remain on. The cut out will reset automatically and oven switch on.

If this operates frequently there is a fault with your appliance. Contact your local service office.

# Oven Temperature Charts – Meat

24

Meat		Top Oven Cooking			Fan Oven Cooking			
Meat	Pre-heat	Temperature °C	Time (approx.)	Position in Oven	Meat	Pre-heat	Temperature °C	Time (approx.)
Beef/ Lamb (slow roasting)	Yes	170/180	35 mins per 450g (1 lb) + 35 mins over.	Runner 1 from bottom of oven.	Beef	No	160/180	20-25 mins per 450g (1lb) + 20 mins extra
Beef/ Lamb (foil covered)	Yes	190/200	35-40 mins per 450g (1 lb)		Lamb	No	160/180	20-30 mins per 450g (1lb) + 25 mins extra
Pork (slow roasting)	Yes	170/180	40 mins per 450g (1 lb) + 40 mins over		Pork	No	160/180	25-30 mins per 450g (1lb) + 25 mins extra
Pork (foil covered)	Yes	190/200	40 mins per 450g (1 lb)		Veal	No	160/170	25-30 mins per 450g (1lb) + 25 mins extra
Veal (slow roasting)	Yes	170/180	40-45 mins per 450g (1 lb) + 40 mins over		Chicken/ Turkey up to 4kg (8 lb)	No	160/180	18-20 mins per 450g (1lb) + 20 mins extra
Veal (foil covered)	Yes	190/200	40-45 mins per 450g (1 lb)		Turkey 4 to 5.5kg (8 to 12 lb)	No		13-15 mins per 450g (1 lb) at 150/160°C
Poultry/Game (slow roasting)	Yes	170/180	25-30 mins per 450g (1 lb) + 25 mins over		over 5.5kg (12 lb)			allow 12 mins per 450g at 150°C
Poultry/Game (foil covered)	Yes	190/200	25-30 mins per 450g (1 lb)		Casserole Stews	No	140-150	1½ - 2 Hrs
Casserole Cooking	Yes	150	2-2½ hrs					

**If using aluminium foil, never:** 1. Allow foil to touch sides of oven. 2. Cover oven interior with foil. 3. Cover shelves with foil.

The most accurate method of testing the readiness of joints of meat or whole poultry is to insert a meat thermometer into the thickest part of a joint, or the thickest part of poultry thighs, during the cooking period. The meat thermometer will indicate when the required internal temp has been reached.

**Beef -** Rare: 60°C      **Lamb:** 80°C      **Poultry:** 90°C  
 Medium: 70°C      **Pork:** 90°C  
 Well Done: 75°C      **Veal:** 75°C

Always fit the screw prior to use.

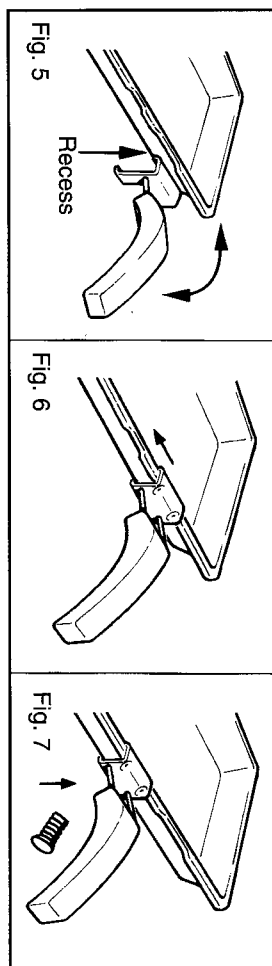

**Fixing the Grill Pan Handle**  
 Fix the grill pan handle securely in position before use.  
 The grill pan handle is detachable from the pan, to facilitate cleaning and storage.  
 The handle fits onto the grill pan edge with the small recess, Fig. 5.

Tilt the handle over the recess and slide it towards the centre, Fig. 6  
 Ensure the handle is fully located Fig. 7.  
 Insert the washer and fixing screw and tighten fully to ensure handle is secured.

21

## Cooking in the Top Oven – Conventional Cooking

The Top Oven can be used to cook small quantities of food or used in conjunction with the Main Oven to provide additional cooking space so often necessary when entertaining.

The oven is designed so that the grill element operates at a reduced heat output (element will not glow), combined with a heating element situated underneath the floor of the oven.

### Do not place items directly onto the floor of the oven.

To ensure even cooking of the food it is important that cooking utensils are positioned correctly on the oven shelf directly beneath the element. (As a guide, the front of the utensil should be approximately 100 mm/4 in from the front of the shelf.)

There are two cooking positions, the shelf placed on runner 1 or 2 (from the base).

### Food or utensils must never be placed directly on the floor of the oven.

There should always be at least 25mm (1 in) between the top of the food and the grill element.

Do not use utensils larger than 300mm x 230mm (12in x 9in).

Larger utensils should be used in the Main oven.

### Operation

To heat the oven, turn the Top Oven/Grill Selector clockwise, selecting the required temperature between 100°C (200°F) and 220°C (425°F) as recommended in the Top Oven Temperature Charts. The Top Oven indicator light will immediately come on and remain on until the oven

reaches the required temperature.

The indicator light will then automatically go off and on during cooking as the thermostat maintains the correct temperature. If the indicator light doesn't come on when the control knob is turned, check that the oven timer is set to Manual as described in 'Oven Timer Operation'.

### Cooking Meat/Poultry in the Top Oven

The Top Oven is most useful for the longer slower cooking required for cheaper cuts of meat – casserole cooking, pot roasting, braising etc. Small joints of meat up to 1.5 kg (3 lb), or poultry, up to 3.6 kg (8 lb) in weight can be roasted in a small meat pan in the Top Oven, but should preferably be 'slow roasted' or covered with a lid of aluminium foil (one or two incisions in the top of the foil will allow the meat or poultry to brown).

Larger joints of meat, and poultry weighing more than 3.6 kg (8 lb), should be roasted in the Main Oven.

**Do not use the Main Oven meat pan or the grill pan as a meat pan in the Top Oven as air circulation will be seriously restricted.**

### Top Oven as a Warming Compartment for Plates and Dishes

Place the plates and dishes on the shelf that has been positioned on runner 1 of the oven and turn on the Top Oven/Grill Selector clockwise to the Platemaking position for 10-15 minutes. **DO NOT** use the grill control.

## Oven Temperature Charts – Baking

Baking Food	Top Oven Cooking				Fan Oven Cooking		
	Pre-heat	Temperature °C	Time in mins.	Position in Oven	Pre-heat	Temperature °C	Time in mins.
Scones	Yes	210/220	10-15	Runner 1 from bottom of oven.	Yes	210/220	8-10
Small Cakes	Yes	180/190	20-25	Runner 1 from bottom of oven.		170/180	15-20
Victoria Sandwich	Yes	170/180	20-30	Runner 1.		160/170	20-25
Sponge Sandwich (fatless)	Yes	180/190	20-25	Runner 1 from bottom of oven.	Yes	170/190	15-20
Swiss Roll	Yes	200/210	10-15	Runner 1 from bottom of oven.	Yes	180/200	12-15
Semi-rich Fruit cakes	Yes	150/160	60-75 7 inch	Runner 1.		140/150	75-90
Rich Fruit Cakes	Yes	140/150	Time Dependent on size	Runner 1.		130/140	Depending on size
Shortcrust Pastry	Yes	190/200	Time Dependent on recipe	Runner 1 from bottom of oven.		190/200	45-50
Puff Pastry	Yes	200/210	Time Dependent on recipe	Runner 1 from bottom of oven.		190/200	Dependent on use
Yorkshire Pudding	Yes	190/200	30-40	Runner 2 from bottom of oven.	Yes	180/190	40-45
Individual Yorkshire Puddings	Yes	200/210	20-30	Runner 2 from bottom of oven.	Yes	190/200	20-25
Milk Pudding	Yes	140/150	90-120	Runner 1.		130/140	105-135
Baked Custard	Yes	150/160	40-50	Runner 1.		140/150	40-50
Bread	Yes	200/210	30-45	Runner 1.	Yes	200/210	45-50
Meringues	Yes	100	150-180	Runner 2 from bottom of oven.	No	80-90	180-240

Note: If soft margarine is used for cake making, temperatures recommended by the manufacturers should be followed. Temperatures recommended in this chart refer to cakes made with block margarine only.

Download from [www.Somanuals.com](http://www.Somanuals.com). All Manuals Search And Download.

## Free Manuals Download Website

<http://myh66.com>

<http://usermanuals.us>

<http://www.somanuals.com>

<http://www.4manuals.cc>

<http://www.manual-lib.com>

<http://www.404manual.com>

<http://www.luxmanual.com>

<http://aubethermostatmanual.com>

Golf course search by state

<http://golfingnear.com>

Email search by domain

<http://emailbydomain.com>

Auto manuals search

<http://auto.somanuals.com>

TV manuals search

<http://tv.somanuals.com>