

## Hotpoint Service Offices

SERVICE CALL: If you have a problem with your appliance ring your local Service Office. SPARES and ACCESSORIES: To purchase spares and accessories send your Accessories Order Form to your Spares Centre. If the accessory or spare part you want is not on the form then contact your Spares Centre for prices and availability. Please address all correspondence to Hotpoint Spares Centre or Hotpoint Service Office as applicable.

Service Offices and Spares Centres are open between 8.30am-5.00pm Monday to Friday, except on Public Holidays. 8.30am-12.30pm Saturdays

### EASTERN

- **NORWICH:**  
92 Upper St. Giles Street, NR2 1LT.  
Tel: **Norwich (0603) 620561.**
- **PETERBOROUGH:**  
Celta Road, PE2 9UB.  
Tel: **Peterborough (0733) 64741.**
- **LUTON:**  
5 Crawley Road, LU1 1HX.  
Tel: **Luton (0582) 452211.**
- **ESSEX:**  
Industrial Buildings,  
Beehive Lane, CM2 9TE.  
For postal codes RM1G  
Chelmsford (0245) 492433  
Remainder of Essex  
Chelmsford (0245) 269331.

### NORTH EAST

- **NEWCASTLE:**  
31 Mosley Street, NE1 1YF.  
Tel: **Newcastle (091) 7321008**
- **HULL:** Custom House Building,  
Whitefriargate, HU1 2EU.  
Tel: **Hull (0482) 224777.**
- **WETHERBY:** Sandbeck Lane, LS22 4TW  
Tel: **Service Office Wetherby**  
**(0937) 581261/581444**  
Spares Centre Wetherby  
**(0937) 581221.**

### SOUTH WEST

- **PLYMOUTH:**  
69 Murtle Plain, PL4 6JH.  
Tel: **Plymouth (0752) 262631.**
- **SOUTHAMPTON:**  
South Hampshire Industrial Park,  
Salisbury Road, Totton, SO4 3SA  
Tel: **Service Office Totton (0703) 861981/**  
**667374**  
Spares Centre Totton **(0703) 867933.**

### EAST MIDLANDS

- **NORTHAMPTON:**  
39B Cambridge Street, NN8 1DW.  
Tel: **Wellingborough (0933) 223669.**
- **NOTTINGHAM:** Ashing Street, NG2 3UB.  
Tel: **Service Office Nottingham**  
**(0602) 862431/864322**  
Spares Centre Nottingham  
**(0602) 860387.**

### NORTH WEST

- **KENDAL:** 29 Highgate, LA9 4SX.  
Tel: **Kendal (0539) 724463.**
- **PRESTON:** 24/25 Cannon Street,  
PR1 3NR. Tel: **Preston (0772) 824311.**
- **MERSEYSIDE:** 40 Cowley Hill Lane,  
WA10 2AD. Tel: **St Helens (0744) 35152.**
- **MANCHESTER:** 44/46 Station Road, Heaton  
Mersey, Stockport, SK4 3OT.  
Tel: **Service Office (061) 442 8677 (South)**  
**061-432 0513 (North)**  
Spares Centre 061-432 0255.

### WALES

- **NORTH WALES:**  
Conwy Road, LL31 9RZ  
Tel: **Deganwy (0492) 582626.**
- **SOUTH WALES:**  
19 Western Avenue, Bridgend Industrial Estate  
CF31 3SL.  
Tel: **(0656) 664121 for postal codes**  
**CF, SA, SY23-25 (0656) 655554 for**  
**BS, GI, (not 55), HR, SY15-18, LD1-4, NP**  
Spares Centre South Wales **(0656) 766111.**

### LONDON and SOUTH EAST

- **SUSSEX:** 1 Kingswood, North Street,  
Hailsham, BN27 1DD.  
Tel: **Hailsham (0323) 842733.**
- **WEMBLEY:** 68 East Lane, HA9 7PQ.  
Tel: **Office for S. Herts and Middlesex**  
**081-904 4399**  
Office for postal codes  
**W, NW, WC, SW 1, 3, 5, 6, 7, 10**  
**081-904 1250**  
**N, E, EC 081-908 4722**  
**SE and rest of SW 081-908 2511**  
Spares Centre 081-904 0201.
- **KENT:** Larkfield Trading Estate,  
New Hythe Lane, Larkfield, ME20 6SW.  
Tel: **Service Office Maidstone (0622) 716571**  
Spares Centre Maidstone  
**(0622) 716631.**

### SCOTLAND

- **ABERDEEN:** Holbeck House,  
68 Garden Place, Aberdeen, AB1 1UL.  
Tel: **Aberdeen (0224) 642283.**
- **EDINBURGH:**  
35 West Bowling Green Street,  
Leith, EH6 5NX.  
Tel: **031-554 1431.**
- **RENFREW:** West Lodge Road,  
Blythswood Estate, PA4 9EN.  
Tel: **Service Office 041-886 6241**  
Spares Centre 041-886 5611.

**CHANNEL ISLANDS** — Service provided by agents  
The normal United Kingdom guarantees apply and all services schemes are available.  
**JERSEY:** 19 Don Street, St. Helier. Tel: **(0534) 216295**  
Clos D'Ormes, Poincaré, St. Clements. Tel: **(0534) 548006**  
**GUERNSEY & SARK:** Valpays Stores, Grande Rue, St Martin, Guernsey. Tel: **(0481) 38422.**  
Lowlands, Braye Road, Vale, Guernsey. Tel: **(0481) 48264.**  
**ALDERNEY:** 32 High Street, Alderney. Tel: **(0481) 822686.**

Spares and accessories may be ordered from Hotpoint Spares Administration Dept., Celta Road, Peterborough, PE2 9UB.  
Tel: **Peterborough (0733) 66496.**  
In accordance with its policy of progressive product design,  
the Company reserves the right to alter specifications.  
Hotpoint Ltd, Peterborough, PE2 9UB, England

# HOTPOINT COMBINATION MICROWAVE OVEN USER HANDBOOK MODEL 6640

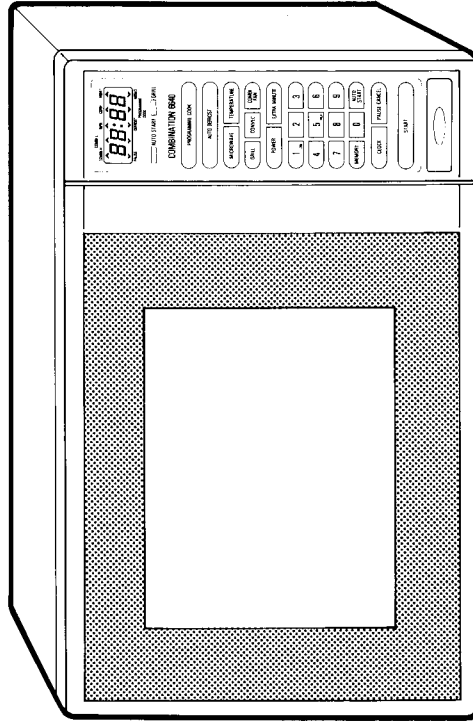

# Hotpoint®

Introduction	3
Specifications	3
Installation Instructions	4-5
Important Safety Instructions	6-10
Know Your Combination Microwave Oven	11
Control Panel	12
Accessories	13
How to Set the Oven Controls	14
<i>Clock</i>	15-16
<i>Microwave cooking</i>	17
<i>Auto defrost</i>	18-19
<i>Grilling</i>	20
<i>Convection cooking</i>	21
<i>Combi cooking</i>	22
<i>Delayed start</i>	23-24
<i>Memory feature</i>	25
<i>Minute plus feature</i>	25-26
<i>Programme cook</i>	27
<i>Programming combination</i>	
Cleaning and Maintenance	28-29
Cooking Utensils	30
Cooking Techniques	31-32
Questions and Answers	33
Before Calling for Service	34
Service Cover	35
Service Offices	36

**HOTPOINT SERVICE COVER**

**Satisfaction Guaranteed or Your Money Back**

Hotpoint gives you a unique 'Satisfaction Guaranteed' promise — valid for ninety days after you have purchased your Hotpoint product. If there is a problem with your Hotpoint appliance just call your Hotpoint Service Office. If necessary we will arrange for an engineer to call. If the problem is not resolved by us under this Guarantee, Hotpoint will replace your appliance or, if you prefer, give you your money back. This Guarantee is additional and subject to the terms of Hotpoint's Five Year Parts Guarantee.

**Hotpoint's Free Five Year Guarantee**  
From the moment your appliance is delivered, Hotpoint guarantees it for **FIVE YEARS**.

- In the Five Years all replacement parts are **FREE** provided they are fitted by our own Service Engineer. During the first year our Engineer's time and labour is also free. Our Guarantee also covers loss of food in our Refrigeration and Freezer products up to £250 during the first year.
- After the first year we will charge for our Engineer's time and labour. We do, however, operate a range of Service Plans (see opposite) which for an annual payment enables you to cover any repair costs which may be necessary.
- All our service repairs are guaranteed for twelve months in respect of our labour and any parts fitted.
- The appliance must be used in the United Kingdom and must not be tampered with or taken apart by anyone other than our own Service Engineer.
- Our Guarantee does not cover the cost of any repair which is needed because of power cuts, accidents or misuse. Nor does it cover the cost of any visit to advise you on the use of the appliance. Please read the instruction book thoroughly.
- If at any time during the Guarantee period we are unable to repair your appliance, we will refund any repair costs paid to us in the previous twelve months. We will also offer you a new appliance at a reduced charge instead of a repair.
- Our Guarantee is in addition to and does not affect your legal rights.
- Should you need independent advice on your consumer rights, help is available from your Consumer Advice Centre, Law Centre, Trading Standards Department and Citizens Advice Bureau.
- All Hotpoint servicing is done by our own Service Organisation located throughout the United Kingdom and Southern Ireland. It will be happy to deal with any problems.

**Hotpoint's Service Care**

Whether you have just one or a number of Hotpoint appliances in your kitchen Hotpoint has a range of Service Schemes to give you complete peace of mind.

**Service Cover**

One annual payment covers you for all repairs for **Individual appliances**.  
Service Cover also covers loss of food up to the value of £250 in our refrigeration and freezer products. If two or more appliances are covered a 20% reduction is made on each fee. There is also the option of **Service Cover with Maintenance** at an additional cost. Service Schemes are renewable each year by mutual agreement.

**Kitchen Cover**

One annual payment covers you for all Repairs and a Maintenance Check for **all Hotpoint appliances owned** which are less than ten years old. Kitchen Cover also covers loss of food up to the value of £250 in our refrigeration and freezer products. Any additional Hotpoint appliances purchased after you have joined **Hotpoint Kitchen Cover** will automatically be included during the current annual period of cover without any further charge.

**Appliance Registration**

To ensure that you have the opportunity to benefit from any of the above Service Schemes you should complete and return immediately the Appliance Registration Form supplied with your appliance. Full details and costs of our Service Schemes together with an application form will be sent to you at the end of the first year of the guarantee.

**Annual Safety/Maintenance Checks**

Hotpoint strongly recommends that all its appliances are regularly checked for electrical and mechanical safety whether or not they are covered by a Service Plan.

**Proof of Purchase**

For future reference please attach your purchase receipt to this booklet and keep it in a safe place.

**Spares and Accessories**

Spares and accessories can be ordered from your local Hotpoint Spares Centre (listed on the back page), using the order form enclosed.

## BEFORE CALLING FOR SERVICE

You can often correct operating problems yourself. If your microwave/grill oven fails to work properly, locate the operating problem in the chart below and try the solutions marked for each problem.

If the microwave/grill oven still does not work properly, contact the nearest Service Centre.

### PROBLEM

#### Oven will not start

1. Is the power supply switched on?
2. Is the door closed?
3. Has a cooking programme been selected and the start button operated?
4. Has the cooking time been set?

#### Arcing or sparking

1. Always use correct cookware.
2. Do not operate an empty oven.

#### Unevenly cooked foods

1. Always use correct cookware.
2. Turntable must be used.
3. Was the food turned or stirred?
4. Was the food completely defrosted?

#### Overcooked foods

1. Has the correct programme and time been used?

#### Undercooked foods

1. Always use correct cookware.
2. Was the food completely defrosted?
3. Has the correct programme and time been used?
4. Check to see that the oven ventilation ports are not restricted.

#### Improper defrosting

1. Always use correct cookware.
2. Turntable must be used.
3. Was the food turned or stirred?
4. Has the correct programme and time been used?

**NOTE:** It is quite normal for steam to be emitted around the door during the cooking cycle. The door is not intended to seal the oven cavity completely but its special design contributes to the complete safety of the appliance.

#### NOTE:

1. Do not attempt to operate the oven while empty as this will cause damage.
2. As an exhaust is located in the rear of the oven, install the oven so as not to block the ventilation ports.

## INTRODUCTION

This instruction book has been carefully designed to help you get the most out of your new microwave oven. You will find that it will take you a little time to become familiar with the functions and facilities which your oven offers you. By taking the time to read these instructions and by following them carefully you will learn more quickly, and make fewer mistakes than if you try to manage without reading them.

### What the instruction book is designed to do

The purpose of this instruction book is to show you what your oven can do. It will help you to understand the control panel and all the functions of the oven. It takes you through all the different things you can do in easy steps.

As well as this instruction book, you have also been given a cookery book specially designed to accompany your oven. However, all the information you will need to get started with your new oven is included in this instruction book. The basic cooking information is complemented by more detailed recipes in the cookery book and the two books are designed to be used together.

Your new oven has been labelled in accordance with the new MAFF labelling scheme. The label is located on the oven door, and it informs you of the power output in watts (800W) and the heating category (D). Most packaged food suitable for microwaving will be marked with these symbols. After heating always check that the food is piping hot throughout.

**Before you do anything with your oven, please read the Important Safety Instructions on pages 6 to 10. This is for your own safety and to make sure you don't damage your new oven.**

## SPECIFICATIONS

AC Line Voltage:

Single phase 240V, 50Hz

AC Power Required:

2.6kW

Output Power:

800W (IEC 705)

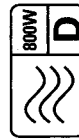

Microwave Frequency:

2450MHz

Outside Dimensions:

527mm (W) x 365mm (H) x 475mm (D)

Cavity Dimensions:

330mm (W) x 229mm (H) x 330mm (D)

Oven Capacity:

25 litres

Cooking Uniformity:

Turntable system (ø 360mm)

Weight:

Approx. 23.5kg

As a part of our policy of continuous improvement, we reserve the right to alter design and specification without notice.

## INSTALLATION INSTRUCTIONS

### HOW TO EXAMINE YOUR MICROWAVE OVEN AFTER UNPACKING

1. Take all of the packing material from inside the oven and remove all the protective film and labels from the oven door.
2. Check the oven for any damage. If you notice any damage please do not use it, contact your dealer.

### WHERE TO PLACE YOUR MICROWAVE OVEN

Place the oven on a flat and level surface, strong enough to take the weight, plus the heaviest item likely to be cooked.

#### IMPORTANT NOTE:

- Take care when lifting the oven, it is heavy.
- The oven must not be located in areas where heat and moisture are generated and not near to easily combustible materials (e.g. curtains).
- Do not install the oven in a humid place, where it could damage the oven.
- Do not store or use the oven outdoors.

#### ELECTRICAL CONNECTION

**WARNING – THIS APPLIANCE MUST BE EARTHED.**

#### REFER TO RATING PLATE FOR VOLTAGE AND CHECK THAT THE APPLIANCE VOLTAGE CORRESPONDS WITH THE SUPPLY VOLTAGE.

**Applicable only if the moulded plug is removed or a plug is not supplied**

The flexible mains lead must be correctly connected, as below, to a three pin plug of not less than 13amp capacity. You must use a 3 pin plug which should be marked with the number BS 1363 and it should be fitted with a BROWN coloured 13 amp fuse marked with the number BS 1362.

We recommend the use of good quality plugs and wall sockets that can be switched off when the machine is not in use.

**IMPORTANT:** The wires in the mains lead fitted to this appliance are coloured in accordance with the following code:

GREEN AND YELLOW — EARTH  
BLUE — NEUTRAL  
BROWN — LIVE

As the colours of the wires in the mains lead of this appliance may not correspond with the coloured markings identifying the terminals in

your plug, proceed as follows:—

The wire which is coloured green and yellow must be connected to the terminal in the plug which is marked with the letter E or by the earth symbol  or coloured green or green and yellow.

The wire which is coloured blue must be connected to the terminal which is marked with the letter N coloured black, or blue.

The wire which is coloured brown must be connected to the terminal which is marked with the letter L or coloured red, or brown.

When wiring the plug, ensure that all strands of wire are securely retained in each terminal. Do not forget to tighten the mains lead sheath clamp. Like most appliances in your house, your oven must be connected to a single phase 240 Volt 50-Hz alternating current supply. If your electricity supply point has only two pin socket outlets, or if you are in doubt, consult a qualified electrician.

If you do not make the proper electrical connections you will damage your microwave oven and possibly injure yourself. Neither the manufacturer nor the supplier are liable if this happens.

#### MOULDED PLUGS (when fitted)

Should it be necessary to remove a moulded on plug from the mains cable, it should be cut off and replaced with a suitable replacement. The moulded plug cannot be used for any other appliance, therefore remove the fuse and dispose immediately and safely to prevent anyone, especially children from plugging it in to a wall socket, which will create a safety hazard.

Should the mains lead ever require replacement, it is essential that this operation be carried out by a qualified electrician and should only be replaced with a flexible cord obtained from the manufacturer.

#### Applicable only if a moulded plug is fitted

After replacement of a fuse in the plug, the fuse cover must be refitted. If the fuse cover is lost, the plug must not be used until a replacement cover is obtained. The colour of the correct replacement fuse cover is that of the coloured insert in the base of the plug or the colour that is embossed in words in the base of the plug recess or elsewhere on the plug. Always state this colour when ordering a replacement fuse cover.

## QUESTIONS AND ANSWERS

#### Q: I accidentally ran my microwave oven without any food in it. Is it damaged?

A: We do not recommend operating the microwave oven without any food. However, running the oven empty for a short time will not damage the oven.

#### Q: Can I open the door when the oven is operating?

A: The door can be opened anytime during the cooking operation. Microwave energy will be instantly switched off and the time setting will maintain until the door is closed.

#### Q: Does microwave energy pass through the viewing screen in the door?

A: No. The metal screen bounces back the energy to the oven cavity. The holes are made to allow light to pass through. They do not let microwave energy pass through.

#### Q: My microwave oven causes interference with my TV. Is this normal?

A: Some radio and TV interference might occur when you cook with the microwave oven. This interference is similar to the interference caused by small appliances such as mixers, vacuums, blow drivers, etc. It does not indicate a problem with your oven.

#### Q: Why does my oven light dim?

A: When cooking with DEF. power, the oven must cycle to obtain the selected power levels. The oven light, dims and clicking noises can be heard when the oven cycles.

#### Q: When is the oven light on and off?

A: The oven light is on during the cooking time.

#### Q: Why does steam accumulate on the oven door?

A: During cooking, steam is given off from the food. Most of the steam is removed from the oven by the air which circulates in the oven cavity. However, some steam will condense on cooler surfaces such as the oven door. This is normal.

#### Q: Sometimes warm air comes from the oven vents. Why?

A: The heat given off from the cooking food warms the air in the oven cavity. This warmed air is carried out of the oven by the air flow pattern in the oven. There are no microwaves in the air. The oven vents should never be blocked during cooking.

#### Q: Why does the smoke come out of the exhaust vent at the back of oven?

A: It is normal for smoke to come out of the vents during cooking. Smoke may be produced when food is overcooked.

## Microwave cooking techniques

You also need to know the important techniques for microwave cooking. The important techniques of the food are:

### Quality of the Food

1. As microwaves will cook quickly, when roasting meat, better cuts should be used.
2. More economical cuts are recommended to be cooked by casseroles, stewing, pot roasting or cooking on a Combination Programme.
3. Vegetables and fish should be as fresh as possible to obtain best results.

### The starting temperature

1. Cold food takes longer to cook than food at room temperature.
2. Recipes assume that food has been stored at its normal storage temperature e.g. fish and chicken from a fridge, vegetables and soup at room temperature.



### The density

1. Dense or solid foods e.g. whole potatoes will take longer to cook than less dense foods e.g. fresh peas.

### The composition

1. Food with high fat or sugar content will heat more quickly than food with a lower content.
2. Take care when you reheat mince pies and Christmas pudding which are both high in sugar and fat.

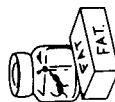

### Size and Shape

1. This affects the overall cooking times.
2. When cooking more than one of a particular food e.g. jacket potatoes — choose items of the same size so they cook evenly.
3. If different sized items are cooked together uneven cooking will occur.

### The arrangement

1. Arrange food so that the thickest part is towards the outside of the dish.
2. A good example is chicken drumsticks where the thinner bony ends won't require as much cooking as the thicker ends.

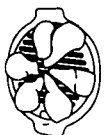

### Covering

1. Certain types of food benefit from being covered during microwave cooking.
2. Covering will prevent splattering and help foods cook evenly.
3. Use a lid or microwave plastic wrap.

### Piercing

1. Always pierce foods which have a skin or membrane. These include: eggs, potatoes, tomatoes, apples, sausages, aubergines.
2. If you don't pierce them, steam will build up inside and they may explode.



### Stirring and turning

1. Always either stir or turn food during cooking wherever possible, for example, casseroles so that the hot food on the outside is mixed with the cooler food.
2. Turn joints of meat or poultry over halfway through their cooking time to ensure even cooking.



### Standing time

This is an essential part of the cooking time to ensure food is completely cooked. This standing time allows the heat to spread evenly through the food. All food needs to stand and the amount of standing time you should allow is usually given in the recipe.

However, as a rough guide you should stand food for about a third to a half of the cooking time. So for example if you cooked some food for 12 minutes you should let it stand for between approx. 4-6 minutes. Food defrosted in the microwave oven must also be left to stand.



Only 13amp replacement fuses which are ASTA approved to BS1362 should be fitted.

- The socket must be readily accessible to allow easy removal of the plug in an emergency.
- When removing the plug from the wall socket, always grip the plug and never pull out by the mains lead as this will damage the mains lead and the connections inside the plug.
- Make sure that the power supply cord is undamaged, and that it does not run under the oven or over any hot surfaces or sharp edges.
- Do not immerse power supply cord or plug, in water.
- Do insert the plug into the socket completely, otherwise the plug may become overheated and catch fire.
- Do not connect another appliance to the same socket using an adapter as it may cause the house wiring to become overheated and may catch fire.
- If the plug or socket is loose or if the power supply cord is damaged, do not operate the oven and contact your dealer or an authorised service agent. The defective plug, power supply cord or socket may become hot and catch fire during operation or cause electrical shock.

**GENERAL** — It is recommended that the microwave oven is attended during the cooking stages. Exceeding the cooking time and too high a power level leads to overheating of food, which may burn and cause a risk of fire.

**WARNING** — To avoid fire, damage to your oven, burns, electric shock or injury:

**To avoid fire**

- 1. Attendance**  
It is recommended that the microwave oven is attended during the cooking operations.
- 2. Times and power**  
Follow the instructions in the attached cookery book supplied.  
Exceeding the specified cooking times and/or the incorrect programming of a microwave power setting could result in overheating of the item of food, and in extreme circumstances the risk of burning your food and damage to the oven.  
Care should be taken when cooking or heating foods with a high sugar or fat content, such as Christmas pudding, mince pies and fruit cakes.
- 3. Risk of fire**  
In the case of overheating the item of food if the food smokes or burns (because of overheating), the following procedure must be carried out.  
1. Keep the oven door closed.  
2. Turn the oven off and disconnect the plug from the socket.  
If you don't follow these instructions, food may catch fire and damage the oven.
- 4. Disposable containers**  
Use only microwave suitable materials. Do not leave the oven in unattended operation when food is heated or cooked in disposable containers of plastic, paper or other combustible materials, see page 31.
- 5. Ventilation**  
1. Do not block or obstruct the air vent openings.  
2. Do not put anything near the air vent openings that may be ignited easily by the hot air coming out of them.
- 6. Roasting bags**  
Plastic and wire twist ties should not be used within the oven as they may melt or catch fire due to an electrical discharge.

**7. Paper products**

Do not use newspaper or re-cycled paper inside the oven, as these may contain materials that could get hot and cause a fire.

**8. Oil and fat**

Never heat oil or fat. You cannot control the temperature of them so they may overheat and catch fire.

**9. Popcorn**

Unless you have a special microwave popcorn popper never cook popcorn in your oven as it can be dangerous and the results are disappointing. Don't use oil unless the manufacturer recommends the use of it and never heat for longer than stated.

**10. Bottle fruit**

Do not try to bottle fruit in your microwave oven as it requires prolonged high temperatures to do so properly.

**11. Storing foods**

Do not keep food or anything inside the oven when it is not being used except in case of the AUTO START cooking conditions.

**12. Food splash shield** (see diagram page 11)

After each use wipe the splash shield cover on the ceiling of the oven with a soft damp cloth to remove any splashes. If you leave grease on the shield it might overheat next time the microwave is used and start to smoke or even catch fire.

**13. Turntable and walls**

Always wipe up spills and splashes on the turntable and inner oven cavity after cooking. If you leave grease on the turntable it might overheat next time the oven is used and start to smoke or even catch fire.

**14. Check**

Please check the setting after you start the oven, to ensure the oven is operating as desired. Exceeding the cooking time or using too high a power level, leads to overheating of food which may burn and could cause a risk of fire.

**The Background to Cooking by microwaves**

**How microwaves cook and heat food**

1. Microwaves are absorbed by the water, sugar and fat which are in the food. The microwaves make the individual particles vibrate very quickly causing the food to heat up by friction, in the same way that your hands get warm when you rub them together. Most parts of the food are heated by microwaves directly as mentioned above. And the rest of it is heated by conduction of heat from hot food next to it. This is why it is very important that you turn food around, rearrange or stir it so that hot and cooler parts are mixed together for even cooking. You must allow the food to stand (the standing time), otherwise some parts may be cool and slightly undercooked and other parts may be very hot.  
Standing guide, see page 32.

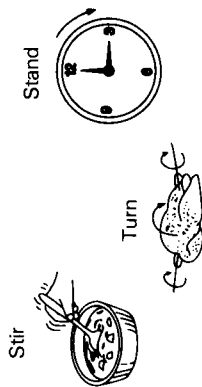









2. Microwaves can pass straight through dishes and utensils which are non-metallic and can then heat the food inside the container. Information about the best type of dishes to use is given on page 30.

3. Microwaves are reflected by metal, which is why the oven is lined with metal and there is a fine metal mesh in the door. This will make sure that there is no danger of the microwaves leaking out.

## MICROWAVE AND COMBINATION COOKING UTENSILS

### Microwave cooking utensils

You can use a variety of cookware in your microwave oven as long as it allows microwaves to pass through into the food. You should try and choose round or oval dishes rather than square or oblong ones. It is very easy to overcook food in the corners of square dishes if they are not shielded during microwave cooking and defrosting.

Utensil	Combination only	Use Microwave only	Advice
	YES	YES	Ideal for cooking, reheating and defrosting.
	NO	YES	Ideal for cooking, reheating and defrosting.
 Microwave bags Roasting bags	NO NO YES	YES YES YES	You should always pierce the bags or wraps to let the steam out. <b>Do not use metal ties to fasten the bags.</b>
	YES/NO	YES/NO	<b>Most ovenproof china and ceramic dishes are suitable, as long as they do not have any gold or silver decoration.</b> These metallic decorations will cause the microwaves to arc (flash). This may cause damage to both your oven and your china. Do not use antique dishes.
	NO	YES	Only suitable for warming food in. Straw and wood are not high temperature resistant material, therefore excessive over heating of these materials may cause a fire in your microwave oven.
	NO	YES	Only suitable for warming food in. Can also be crumpled up and used to absorb fat and splashes when you cook bacon. Paper is not high temperature resistant material, therefore excessive over heating of this material may cause a fire in your microwave oven.
	NO	NO	Reflects microwaves so cannot pass into the food and may cause arcing.
	YES/NO	YES/NO	You can use small pieces of foil to stop overheating of parts of foods you are cooking. But you should not use large pieces of foil, as microwaves are reflected by metal and they must not touch the walls of the oven to avoid arcing. Preferably take food out of foil trays and place in a microwave proof dish. Where microwavable covering or no lid fitted, always remember to stir the product immediately it is defrosted and halfway through the heating cycle. <b>Foil board lids must not be used and must always be removed before heating in microwave oven.</b> <b>Do not place any empty foil container in a microwave oven.</b> If the microwave oven has been used to reheat a product for more than 15 minutes, allow the glass turntable to cool before using again. Care should be exercised when removing any lid or covering from heated food, as hot steam may escape.

NOTE: If you are not sure if a dish is suitable to use, ask the dish manufacturer.

## IMPORTANT SAFETY INSTRUCTIONS

### To avoid damage to your oven

- Visual check**  
Check the oven carefully for any signs of damage. Pay particular attention to:
  - The door, make sure the door closes properly and make sure it is not misaligned or warped.
  - The hinges and safety door latches, check and make sure they are not broken or loose.
  - The door seals and seal surfaces, make sure that they have not been damaged.
  - Inside the oven cavity or on the door, check to be certain that there are no dents or damaged surfaces.

**If there is any damage, please do not operate the oven. Contact your dealer or an authorised service agent, because the damaged oven may cause leakage of microwaves.**

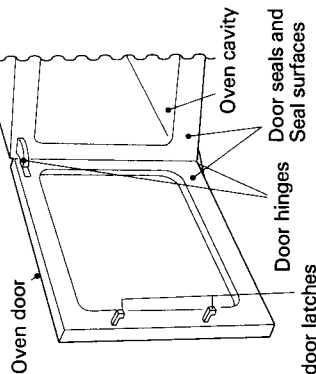

Safety door latches

**It is dangerous for this oven to be adjusted or repaired by anyone except a properly qualified service technician trained by the manufacturer.**

- Door**
  - Do not attempt to operate the oven with the door open. It is important not to deface or tamper with the safety door latches as it could result in exposure to microwave energy with the door open.
  - Do not operate the oven with any object caught in the door seal between the oven front face and the oven door as this may cause microwaves to leak out.
  - Never allow grease or dirt to build up on the door seal and sealing surfaces as this may stop the door working correctly and may cause microwaves to leak out. Wipe the seals and door regularly with a damp cloth, preferably before splashes and grease become dried on to the surface.
- Do not overheat.**
- Stir the liquid before placing the container in oven and again halfway through the heating time.**
- After heating, allow to stand in the oven for a short time, stir again before carefully removing the container.**
- Eggs**  
Never cook eggs in their shells. Steam will build up inside the shell during cooking and the egg will explode. If you want to cook or reheat eggs which have not been broken up by scrambling or mixing, you must always pierce the yolks or these will also explode. You should slice shelled hard boiled eggs before you reheat them in your microwave oven.
- Piercing**  
Always pierce food which has a skin or membrane, for example, potatoes, tomatoes, apples, sausages etc. If you don't pierce them, steam will build up inside and they may explode.

### To avoid electric shock

- Outer cabinet**  
Never remove the outer cabinet, it is very dangerous because there are some high voltage parts inside which can be fatal if touched.
- Holes**  
Do not insert fingers or objects in the holes of the door latches or air vent openings. It may cause an electric shock or damage the oven.

### To avoid explosion and sudden boiling

- Lids**  
Always remove the lids of jars and containers and takeaway food containers, before you microwave them. If you don't, then steam and pressure might build up inside and cause an explosion even after the microwave cooking has stopped.
- Liquids**  
**Warning: When heating liquids, e.g. soups, sauces and beverages in your microwave oven, overheating the liquid beyond boiling point can occur without the evidence of bubbling. This could result in a sudden "boil over" of the hot liquid.**  
To help prevent this happening, the following steps should be followed:
  - Avoid straight sided containers with narrow tops or necks.
  - Do not overheat.
  - Stir the liquid before placing the container in oven and again halfway through the heating time.
  - After heating, allow to stand in the oven for a short time, stir again before carefully removing the container.
- Eggs**  
Never cook eggs in their shells. Steam will build up inside the shell during cooking and the egg will explode. If you want to cook or reheat eggs which have not been broken up by scrambling or mixing, you must always pierce the yolks or these will also explode. You should slice shelled hard boiled eggs before you reheat them in your microwave oven.
- Piercing**  
Always pierce food which has a skin or membrane, for example, potatoes, tomatoes, apples, sausages etc. If you don't pierce them, steam will build up inside and they may explode.

### To avoid burning

- Do not heat baby foods/feeds in a microwave oven. The container may feel cool but the contents could be scalding hot.
- Oven gloves**  
Always use dry, good quality oven gloves to prevent burns when handling utensils that are in contact with hot food. Enough heat from the food can transfer through utensils to cause skin burns.
- Face and hands**  
Avoid steam burns by directing steam away from the face and hands. Slowly lift the farthest edge of a dish's covering and carefully open popcorn and oven cooking bags away from the face.
- Standing back**  
Always stand back when opening the oven door to allow any build-up of heat or steam to disperse. Keep the door closed when the oven is not in use to prevent accidents.
- Foods with filling**  
Cut baked foods with filling after heating to release steam and avoid burns from their jam and liquid contents.
- Temperature**  
**Always** test the temperature of food or drink which has been heated in a microwave oven before you give it to somebody, especially to children or elderly people. This is important because things which have been heated in a microwave oven carry on getting hotter even though the microwave cooking has stopped.
- The temperature of the outside of the container is not a good indication of the temperature of the food or drink inside, so you must test the temperature of the actual contents.

### Guidelines to destroying harmful bacteria

- Check to see if the food is thoroughly cooked. Look for the following signs indicating that cooking temperatures have been reached and food is cooked.
  - Food steams throughout, not just at edge.
  - Centre bottom of dish is very hot to touch.
  - Poultry and thigh joints move easily, poultry juices shows no pinkness.
  - Fish is opaque and flakes easily with a fork.
- To test that the food is cooked fully, insert a meat thermometer in the thickest or densest area, away from areas such as fat and bone. Never leave the thermometer in food during cooking, unless it is approved for microwave oven use.
- Standing time** (see page 32)  
Always allow standing time after microwave cooking/thawing. Standing time is part of the microwave cooking process — it is **not** an optional extra. If you do not leave microwaved food to stand for the time stated in the recipe, there is a chance that it will not be properly cooked.
- Turn over, rearrange and stir**  
**It is important** to turn or rearrange food, and if possible stir it during microwave cooking. If you don't do this, some parts of it may be undercooked or not properly defrosted.
- Bacteria**  
Select, store, and handle food carefully to preserve its high quality and minimise the spread of foodborne bacteria.
- Cook chilled food**  
When reheating Cook Chilled Food, ensure the food is **pipng hot** and if in doubt, extend the heating time declared by the Food Manufacturer.
- Sterilising**  
Do not sterilise baby feeding bottles in microwave ovens, as air bubbles can get trapped, causing incomplete sterilisation. Sterilising solution should not be heated in a microwave oven.
- It is essential to wash meat, poultry products and the cooking utensil before cooking immediately after defrosting.
- It is vitally important to strictly adhere to the basic principles of food handling and hygiene to prevent the possibility of bacterial growth.

### Cleaning

Switch Off and remove plug from socket. It is easier to clean your microwave oven than a conventional cooker as oven surfaces are flat and cool. The daily cleaning procedure is as follows:

Make sure the oven is turned off before cleaning any part.

### Interior

- Do not allow grease, soil and splashes to build up. A build up of grease or food particles on the oven interior can result in damage to the oven as well as loss of cooking power.
- Use only a mild detergent, water and a soft cloth to clean the door surface and interior. **DO NOT** use scouring pads, powder or other abrasive materials.
- To loosen stubborn food particles, place a measuring cup filled with water on the turntable. Operate the oven until the water boils, the steam will help loosen any stubborn particles.
- Odours can be eliminated from the inside of the oven by boiling a solution of one cup of water and several tablespoons of lemon juice in the oven for 5-7 minutes.
- Ensure that the oven door seal and front rim of the oven are kept clean and free from soil.
- Wipe excess moisture from the inside of the oven, including the door and door seal, **AFTER EACH USE.**

**Note:** The moisture on the inside of your microwave oven is normal, and nothing to worry about. It is caused by the steam from the cooking food coming into contact with the cool oven surface.

### Never Pour Water into the Oven

As a safety measure, frequently wipe the inner oven door seal. The turntable is removable. To clean spills, remove and wash in sink or dishwasher. Periodic cleaning under the turntable may be required.

Never try to rapidly cool the turntable (or other cookware) in water while it is still hot. If the turntable is used successively for a long time, it will be heated up to a high temperature. Never dip it into cold water or wipe with a cold dish cloth. Such rapid cooling will possibly cause the turntable to crack or break.

### Exterior

The outer cabinet is painted. Clean with a cloth or sponge, moistened in a mild detergent solution, and then dry with a clean cloth. Do not spill water into the vents. Do not use Petroleum spirit, thinners or any kind of chemical solvent to clean the outer cabinet. The control panel and trim are best wiped with a clean damp cloth, and then wiped immediately with a dry cloth. The door window's outer panel is plastic. Use a damp cloth to wipe clean. Do not use Petroleum spirit, thinners or any kind of chemical solvent to clean the oven door or control panel. **Do not use scouring pads, or abrasive powder.**

### Storage

If you must store your microwave oven, choose a dry, dust-free place. Dust and dampness can affect the oven's working parts.



**To avoid misuse by children**

1. Children should not be allowed to operate or remove items from the oven.
2. **Leaning or swinging**  
Do not allow anyone to lean or swing on the oven door. And do not allow anyone to play with the oven.

**Other warnings**

1. **Repair**  
It is very dangerous for anyone other than a service technician trained by the manufacturer, to perform a repair or service of the oven.  
**Never** adjust or repair the oven by yourself, or never allow anyone who is not a trained service technician to do so.
2. **Modification**  
**Never** attempt to modify the oven in any way.
3. **Working**  
Do not operate the oven if it is not working properly.
4. **Moving**  
**Never** attempt to move the oven while it is operating.
5. **Purpose**  
Only use the microwave oven for cooking/thawing or heating of food. This product is not suitable for any other use.

6. **Domestic use**  
Please note, that the microwave oven is designed for domestic use. The oven is not suitable for commercial, industrial or laboratory use.  
The manufacturer declines any liability for damages caused by improper use.
7. **Keep clean**  
Please clean your microwave oven regularly and remove any stains or fat residues without delay. Failure to do this may affect the quality and safety of the product or prejudice your guarantee.
8. **Plastic wrap**  
Plastic wrap that is specially marked for microwave use can be used for cooking and heating. It is recommended that the plastic wrap does not touch food because it may melt. Vent plastic wrap so steam can escape.
9. **Installation**  
**Never** install the oven at a height where a hazard could be created when removing hot food and liquids.

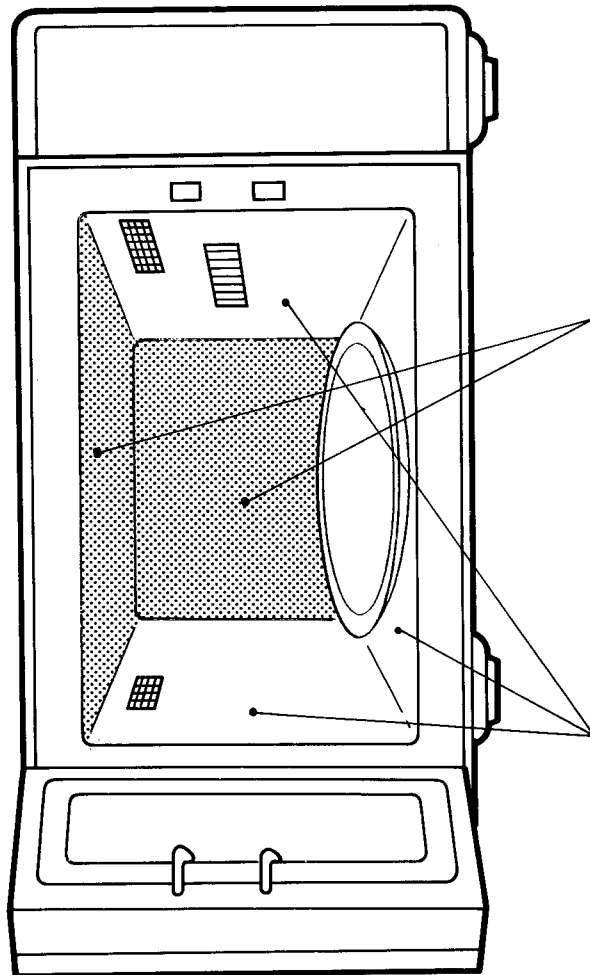

**Stainless steel areas**  
(Two side walls and floor)

**Self-clean areas**  
(Top and back walls)

**CAUTION – To reduce the possibility of trouble with the oven or damaging it:**

1. **Ventilation**
  - a) Do not block the air vent openings of the oven.
  - b) When water or food drops into the inside of the oven through the air vent openings, stop the oven immediately, unplug it and call for the service agent.
2. **Empty oven**  
**Never** use the microwave function with an empty oven as it will damage the oven.
3. **Checking utensils**  
Before you use any dishes or utensils for microwave cooking you must check that they are suitable. Instructions on what kind of dishes and utensils are suitable are found on page 30.
4. **Browning dish**  
Should you wish to use a browning dish, we would suggest that a heat proof plate be placed between turntable and browning dish in order to prevent the glass turntable and roller guide from damage by heat stress. It is important that the recommended preheating time of the dish should not be exceeded.
5. **Self heating material**  
Do not place self heating materials directly onto the turntable (see browning dish above).
6. **Metal**  
Metal utensils should NOT be used for MICROWAVE cooking. Metal reflects microwave energy and may cause an electrical discharge known as arcing.
  - If metal (such as aluminium foil) is used for a special purpose, it must never come into contact with the oven walls during operation, because they may get damaged. **The distance to the oven walls must be kept to at least 2 cm.**
7. **Canned food**  
Never heat cans of food in the microwave oven, (see Metal above).
8. **Turntable**  
For all operations, the roller guide should be correctly installed on the coupling and the turntable should be correctly placed upon it. If you do not do so, the turntable may not turn or may rattle, as a result it may damage the oven. If you operate the oven without the above accessories, the food will not be heated thoroughly.

## IMPORTANT SAFETY INSTRUCTIONS

- Turntable** (continued)  
Do not place food heavier than 10 lbs (5kg) as the turntable motor could become damaged.
- Disposal**  
At the end of the microwave's life, it must be disposed of safely to avoid further use. To make it safe, snap off the door latches, and remove the mains cable. This will prevent the door latching shut and the oven from being powered up.

### NOTE — Information you need to know.

- Guarantee claim (see guarantee card)**  
In the unlikely event of this equipment requiring repair during the guarantee period, you will need to provide proof of date of purchase to the repairing company. Please keep your invoice or receipt, which is supplied at the time of purchase.
- Turntable**  
The turntable will rotate in either direction. The rotary direction of the turntable may change every time you start the oven. The direction of rotation of the turntable does not affect the performance of the oven.
- Oven light**  
The oven light comes on whenever you open the door, and stays on when food is being cooked in the oven.
- Rack**  
When defrosting and/or cooking meat, we recommend the use of a microwave proof roasting rack and dish. This will help to prevent spillage of the juices into the cavity.
- Steam**  
Sometimes food with a high moisture content may give off a lot of steam during cooking. This is quite normal.
- Microwave oven wattage**  
Due to the adoption of the IEC 705 power rating you may find that when following old cook book timings (which have not been rated to IEC 705) they may require adjustment. Either increase or decrease the cooking time according to the condition of the food.
- Door seal**  
The door seal stops microwaves from leaking out of the oven during cooking, but it does not form an airtight seal. This means that you may sometimes see drops of water, light, or feel warm air coming out from around the door. This is quite normal and does not mean that the oven is allowing microwaves to leak out.

## PROGRAMMING COMBINATIONS

This oven has the ability to be programmed to do up to four consecutive functions. These combinations are given below and either the complete programme or part of it can be used.

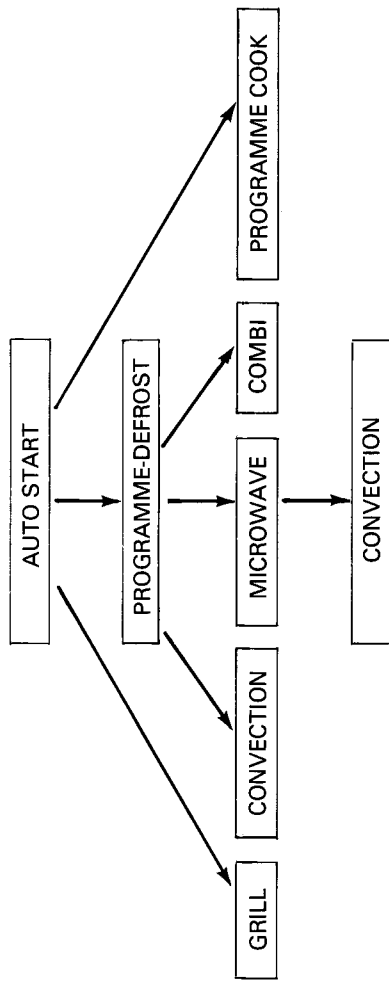

### NOTE:

- The programmes can be set in any sequence.
- Review the programme by touching the function pads before touching START pad.

## PROGRAMME COOK

### DO THIS... THIS HAPPENS...



The oven will now start programmed cook for menu 2. The time of the menu 2, roast beef, is 21 minutes. The timer will start counting down in seconds.

4. Touch **START** pad

5. Three beeps will sound at the end of the cooking time. The indicator light will go off. The display panel will return to the time of day. The oven light will turn off and turntable will stop turning.

#### NOTE:

- The food types and cooking times of the following programmes are: —

#### PC1

1. **Roast Pork up to 1.3kg (2½ lbs)**

Place in suitable dish, position on turntable, select Programme Cook 1. After 15 minutes cooking, turn meat over. At end of cooking, wrap in foil and allow to stand for 10 minutes.

#### PC2

2. **Roast Beef up to 1.3kg (2½ lbs)**

Place in suitable dish, position on turntable, select Programme Cook 2. After 10 minutes cooking, turn meat over. At end of cooking, wrap in foil and allow to stand for 10 minutes.

#### PC3

3. **Roast Chicken up to 1.3kg (2½ lbs)**

Place in suitable dish, position on turntable, select Programme Cook 3. After 12 minutes cooking, turn meat over. At end of cooking, wrap in foil and allow to stand for 10 minutes.

#### PC4

4. **Fish Fillets 450g (1lb)**

Place in suitable dish, cover. Position on turntable, select Programme Cook 4.

#### PC5

5. **Vegetables — Jacket Potatoes 2 x 10oz**

Wash, dry and prick potatoes, wrap in kitchen paper, place on suitable plate, position on turntable, select Programme Cook 5. At end of cooking, wrap in foil and allow to stand for 10 minutes.

#### PC6

6. **Fresh Vegetables 450g (1lb)**

Prepare, slice and wash vegetables, place in container, add 4 tablespoons water, cover. Position on turntable, select Programme Cook 6. At end of cooking, allow to stand 5 minutes before serving.

- The weight of food refers to cooking guide.

#### TO INTERRUPT THE COOKING CYCLE DURING OPERATION — open the door:

- The oven will immediately stop.
- If no further cooking is required, touch PAUSE/CANCEL pad. Touch CLOCK pad and the time of day is displayed.
- To continue cooking, close the oven door and touch START pad. The oven will restart.

## KNOW YOUR COMBINATION MICROWAVE OVEN

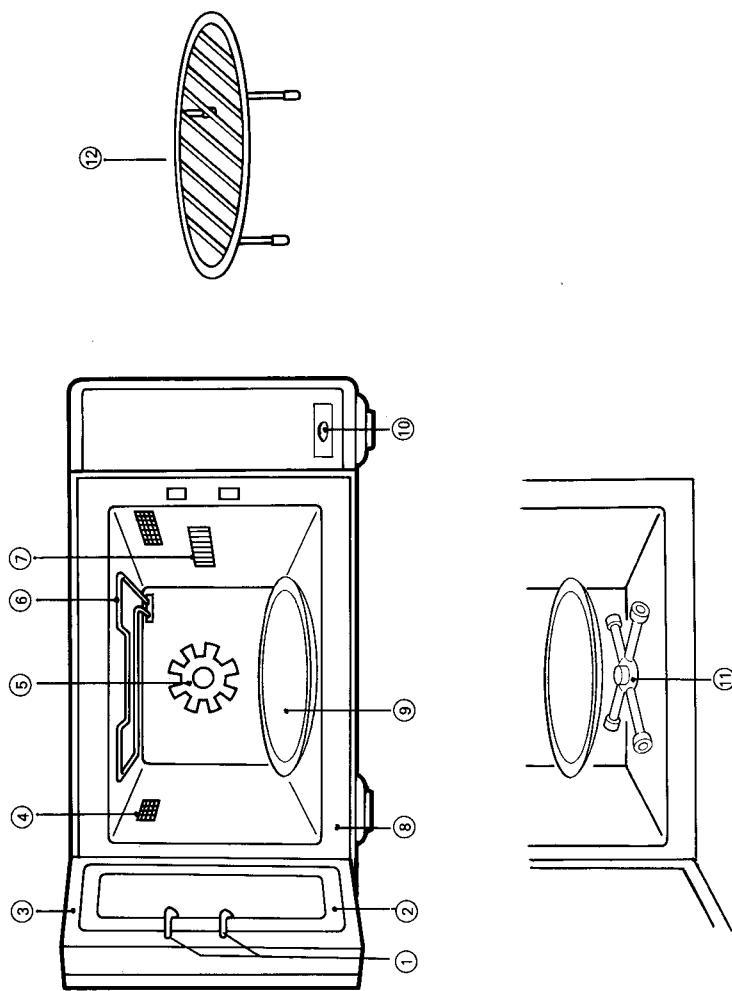

- 1 **Door latch** — When door is closed it will automatically lock shut. If door is opened while the oven is operating, the microwaves will be immediately switched off.
- 2 **Door seal** — The door seal maintains the microwaves with the oven cavity and prevents microwave leakage.
- 3 **Door screen** — Allows viewing of food. Microwaves cannot pass through perforations in screen.
- 4 **Oven lamp** — Automatically turns on during oven operating.
- 5 **Convection fan** — Rotates when convection cooking is selected.
- 6 **Element** — Turns on when convection or grill cooking is selected.
- 7 **Splash shield** — Protects the microwave source from splashes of cooking foods.

- 8 **Oven front seal** — Metal frame surrounding oven opening.
- 9 **Turntable tray** — Rotates during cooking and ensures even distribution of microwaves. It can also be used as a cooking utensil.
- 10 **Door opening button** — To open the door, push the door opening button. When door is closed, it will automatically lock shut. If door is opened while oven is operating, the microwaves will be immediately switched off.
- 11 **Rotating base** — This fits over the shaft in the centre of the oven's cavity floor. This is to remain in the oven for all cooking. It should only be removed for cleaning.
- 12 **Metal rack**

## CONTROL PANEL

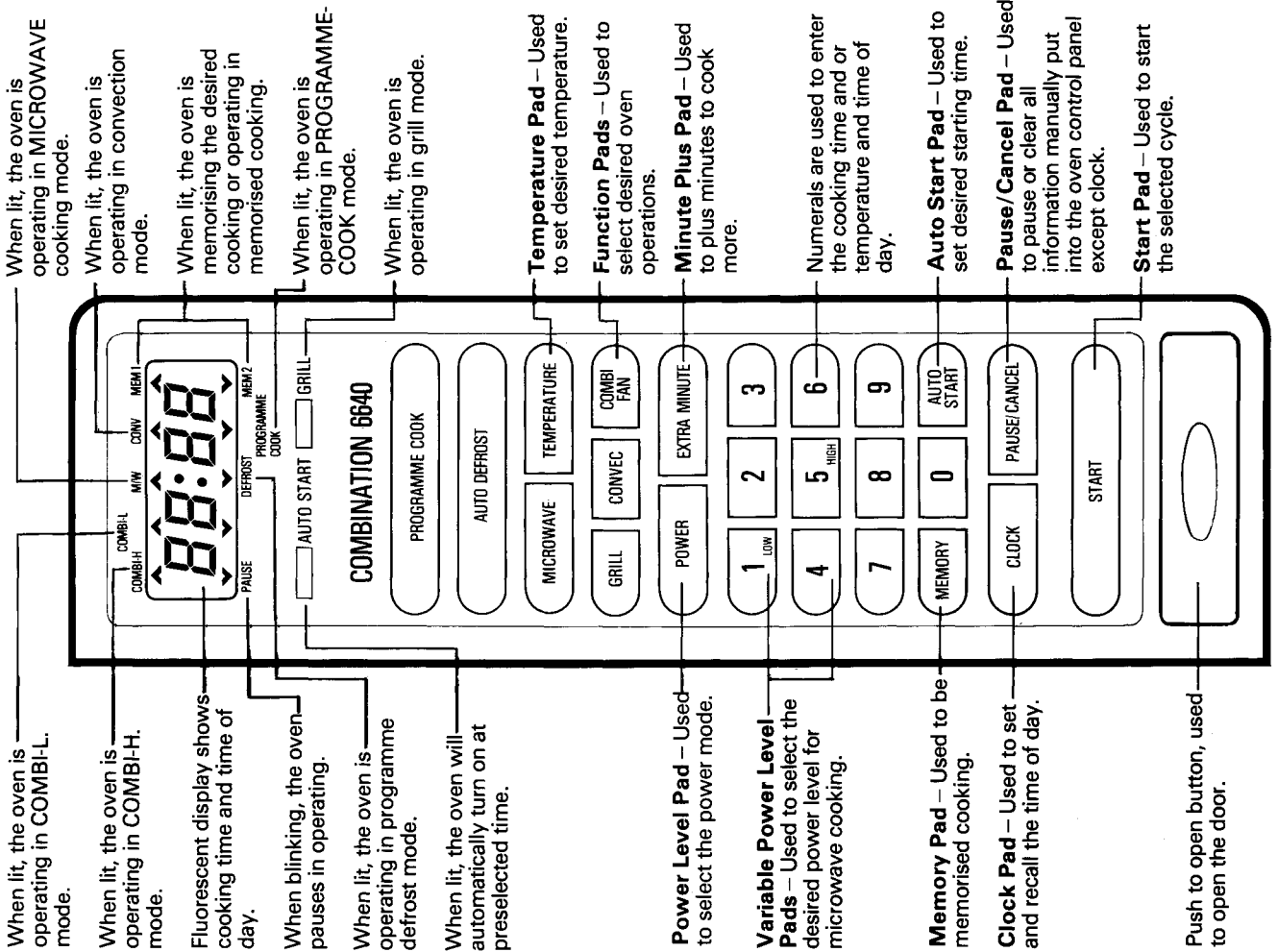

## MINUTE PLUS

### DO THIS ...

#### MINUTE PLUS

2. Touch once MINUTE PLUS pad.

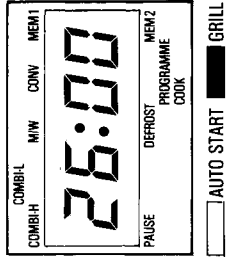

The cooking time will be increased by 1 minute. In this example, 26:00 will show in the display.

## PROGRAMME COOK

### NOTE:

- 6 preprogrammed memories suitable for cooking a wide range of food automatically.
- You don't have to worry about setting cooking times, power or function.

### DO THIS ...

#### PROGRAMME COOK

1. Touch PROGRAMME COOK pad.

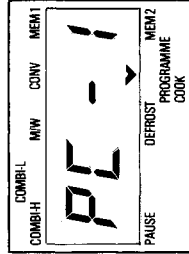

The "PROGRAMME COOK" indicator light will light. "PC-1" will show in the display.

2. Select the desired cooking

For example: roast beef.

#### PROGRAMME COOK

Touch PROGRAMME COOK pad once again.

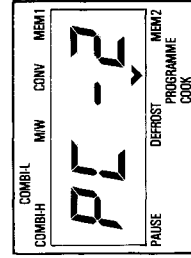

"PC-2" will show in the display.

3. If you want to select other cooking, touch the PROGRAMME COOK pad once again, until display you desired.

## MEMORY

To recall the cooking programme

DO THIS...



1. Touch PAUSE/CLEAR pad.

Clock will show in the display or display will be erased.

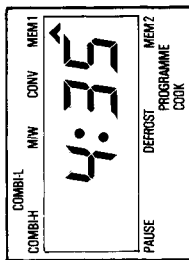

2. Touch to recall the desired memorised cooking.

For example:

MEMORY

1  
LOW

The cooking programme in "MEM 1" will show in the display. In this example, "Defrost for 10 minutes" will show in the display.

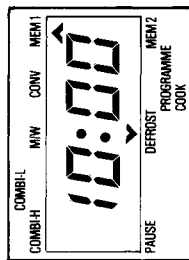

START

3. Touch the START pad.

The oven will now start to defrost for 10 minutes.

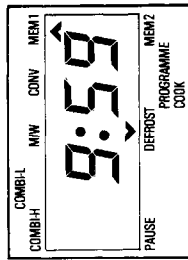

## MINUTE PLUS

NOTE:

- MINUTE PLUS function offers you convenience to increase the desired cooking time by steps of 1 minute.
- Only after selecting the desired cooking function can the MINUTE PLUS function be operated.

DO THIS...

1. Touch to select the desired cooking function and time.

For example:



In this example, The "GRILL" indicator light will light and 25:00 will show in the display.

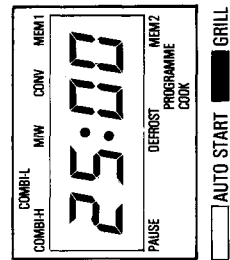

## ACCESSORIES

This oven comes equipped with several accessories. They can be used in various ways to facilitate cooking. Be sure to follow specific directions for their use when given in charts or recipes in the cookbook.

### THE ACCESSORIES AND THEIR USE: ROTATING BASE



This fits over the shaft in the centre of the oven's cavity floor. This is to remain in the oven for all cooking. It should only be removed for cleaning.

### TURNTABLE

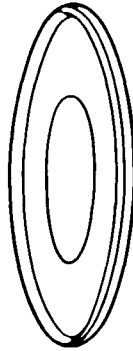

This metal tray fits over the rotating base and locks into place. This is to be used in the oven for all cooking. It also serves as the main cooking surface. It rotates clockwise and counter-clockwise during cooking. It is easily removable for cleaning needs.

**NOTE: The oven should not be operated without the Rotating Base and Turntable Tray in place.**

### METAL RACK

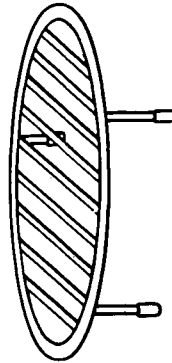

This wire rack is used with the Turntable tray for grilling. When used with the turntable, it facilitates cooking for many food dishes.

**NOTE: The Metal rack is not to be used with the Turntable Tray during microwave-only cooking.**

## HOW TO SET THE OVEN CONTROLS

### TIPS:

- Be sure to read the cookbook's introduction before operating the oven.
- Also remember to read this operating instruction for proper safety information and instruction before using the oven.
- See the cookbook for specific recipes.
- Prior to setting the controls, place one cup of water in the oven, in a heat-proof cup, for testing purposes.
- When setting the controls, every time a pad is pressed, a beep can be heard.

### CLOCK

#### NOTE:

- This is a 12 hour clock.
- When the oven is plugged in, "1:01" appears in the display window.
- The two dots between the hour and minutes are the clock indicator lights. They will start to flash on and off.
- The Time of day will be displayed at all times, except when the oven is operating.
- In the event of a power failure or if the oven is unplugged, the clock will have to be reset for the proper time. Once power is restored or oven is plugged in, the display will show "1:01".
- To reset the time of day, repeat the steps given below.
- To check the time of day while the oven is operating, touch the CLOCK pad and the time will be displayed for 2 seconds.

### SETTING THE CONTROLS

#### DO THIS ... THIS HAPPENS ...

CLOCK

1. Touch the CLOCK pad.

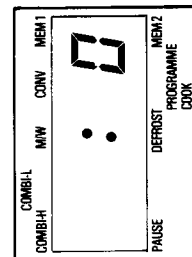

The display will become blank except for the two indicator lights, and a 0 on the right side.

2. Touch the numeral pads for the correct time of day.

For example: 4:35

4 3 5

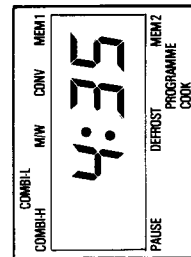

CLOCK

3. Touch the CLOCK pad.

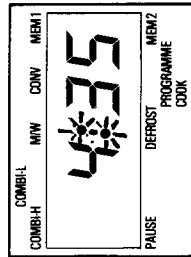

The clock indicator lights will then flash every other second and the clock will start keeping time of day.

## MEMORY

### NOTE:

- When Memory indicator light flashes, then a cooking programme can be stored in the memory.
- When the power supply is interrupted the cooking programme will be erased from the memory.
- Cooking programmes can only be recalled, if previously stored in memory.
- Entering a new cooking programme automatically erases a previously stored memory programme.

### To memorise the desired cooking

#### DO THIS ... THIS HAPPENS ...

1. Select the desired cooking function and time.

For example:

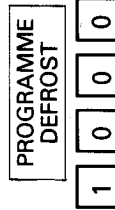

In this example, The "DEFROST" indicator light will light and 10:00 will show in the display.

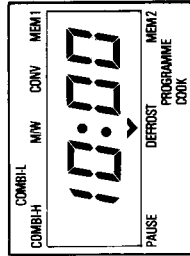

MEMORY

1. Touch MEMORY.

The corresponding two indicators will light on the display and flash every other second.

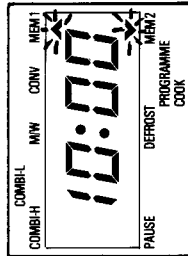

3. Touch the numeral pad.

1 LOW or 2 the desired memory.

For example:

1 LOW

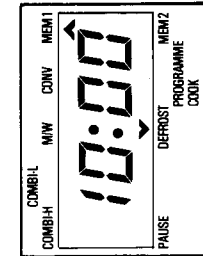

The "MEM 1" indicator light will light on the display and flash every other second.

NOTE: If you touch 2

pad, the "MEM 2" indicator light will light on the display and flash every other second.

START

4. Touch the START pad.

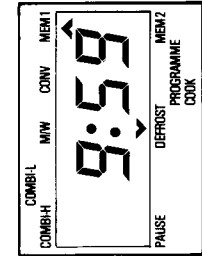

The oven will now defrost for 10 minutes. The cooking programme is automatically stored in the memory.

## ■ AUTO START

### NOTE:

- Auto Start function allows you to set the oven to come on at a later time.
- The clock must be set before the Auto Start function can be set.
- Auto Start function can be set anytime during programming.

### DO THIS . . . THIS HAPPENS . . .

1. Set the clock-or make sure it is set for the correct time of day.

#### AUTOSTART

2. Touch the AUTOSTART pad.

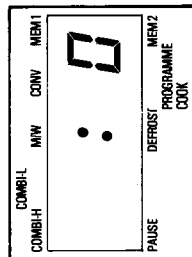

The "AUTO START" indicator light will light.



3. Touch the numeral pads for the desired Start time.

For example: 5:30



In the display, 5:30 will be shown.

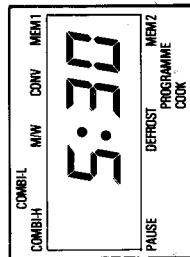

4. Set the cooking programme(s).

#### START

5. Touch the START pad.

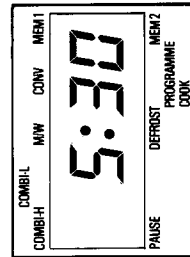

The Auto Start indicator light will now flash. The Delayed Start time is shown in the display. When the time of day reaches the Delayed Start time, the oven will start to cook.

**NOTE:** To cancel or change the Auto Start time and/or programme(s): Touch PAUSE/CANCEL pad, and start the process from the beginning.

## ■ MICROWAVE COOKING

### NOTE:

- To ensure the best microwave and programme Defrost results, be sure to start with a cool oven. This is important if convection or combination was used prior to microwave cooking. Let the oven cool 15-20 minutes with the door slightly open.
- The variable Power Level settings equal the following wattage:

Power level 5	800 Watts
Power level 4	717 Watts
Power level 3	552 Watts
Power level 3	386 Watts
Power level 1	220 Watts

When following recipes from cookbooks it is important to check the wattage against the power levels above.

### DO THIS . . . THIS HAPPENS . . .

#### MICROWAVE

1. Touch the MICROWAVE Pad

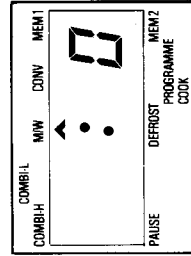

The "MW" indicator light will light.

2. Touch the numeral pads for the desired cooking time.

For example:

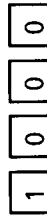

(10 minutes)

10:00 will show in the display.  
**NOTE:** Time can be set up to 99 minutes and 99 seconds.

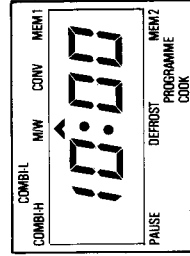

**NOTE:** If steps 3 and 4 are omitted, the oven will cook at full power.

#### POWER LEVEL

3. Touch the POWER LEVEL pad.

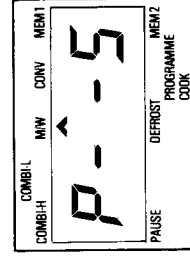

The display will be shown "P-5".

## MICROWAVE COOKING

4. Touch to select the desired microwave power level from

**5** HIGH to **1** LOW

For example

**3** MED

The display will be shown what you touched. This example shows power level 3.

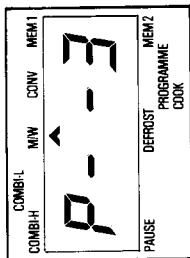

**NOTE:** If steps 3 and 4 are omitted, the oven will cook at full power.

**START**

5. Touch the **START** pad.

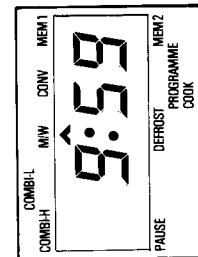

The "M/W" indicator light will light on the display. The timer will start counting down in seconds. The oven will now microwave cook for 10 minutes at MEDIUM power.

6. Three beeps will sound at the end of the cooking time. The indicator light will go off. The display panel will return to the time of day. The oven light will turn off and the turntable will stop turning.

## COMBINATION COMBI COOKING

DO THIS...

**COMBI**

1. Touch the **COMBI** pad.

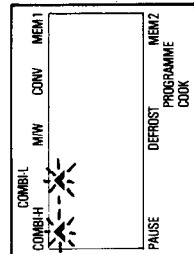

The corresponding two indicators will light on the display and flash every other second.

2. Touch the numeral pad.

**1** LOW or **5** HIGH

for **COMBI** Low or **COMBI** High the desired cooking function.

For example:

**1** LOW

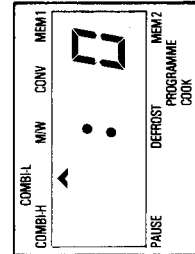

The "COMBI-L" indicator light will light.

**NOTE:** If you touch **5** HIGH pad, the "COMBI-H" indicator light will light.

3. Touch the numeral pads for the desired cooking time.

For example:

**1** **0** **0** **0**

(10 minutes)

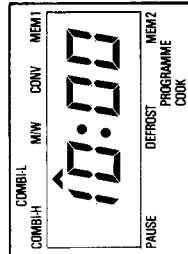

10:00 will show in the display.

**NOTE:** Time can be set up to 99 minutes and 99 seconds.

**TEMP**

4. Touch the **TEMP** pad for cooking temperature setting.

For example: **175°C**

**1** **7** **5**

Touch numeral pads to set the desired temperature.

**NOTE:** It is not necessary to touch the zero for 150, 160, 170, etc.

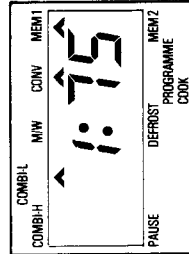

**START**

5. Touch the **START** pad.

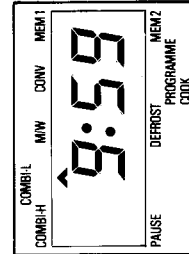

The oven will now start **COMBI-LOW** cooking for 10 minutes at 175°C. The "COMBI-L" indicator lights will light on the display. The timer will start counting down in seconds.

6. Three beeps will sound at the end of the cooking time. The indicator lights will go off. The display panel will return to the time of day. The oven light will turn off and the turntable will stop turning.



## FAN ASSISTED CONVECTION COOKING

### DO THIS ... THIS HAPPENS ...

2. Touch the numeral pads for the desired cooking time.

For example:



(10 minutes)

10:00 will show in the display.  
**NOTE:** Time can be set up to 99 minutes and 99 seconds.

3. Touch the TEMP pad for cooking temperature setting. Touch numeral pads to set the desired temperature.

For example: 175°C



4. Touch START pad.

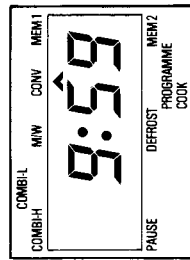

The oven will now start convection cooking for 10 minutes at 175°C. The "CONV" indicator lights will light on the display. The timer will start counting down in seconds.

5. Three beeps will sound at the end of the cooking time. The indicator lights will go off. The display panel will return to the time of day. The oven light will turn off and the turntable will stop turning.

## COMBINATION COMBI COOKING

### NOTE:

- This oven has 2 pre-programmed COMBI settings. COMBI-HIGH has a higher power compared to COMBI-LOW. Foods cooked on COMBI-HIGH include pies, roasts, etc. COMBI-LOW works best with egg dishes, cakes. Please refer to cookbook for further details.
- This oven does the cooking simultaneously with microwave and convection.
- This oven can be set to a minimum temperature of 100°C and a maximum temperature of 250°C.
- For optimum cooking results it is recommended that the oven is pre-heated on the convection mode for 10 minutes prior to use.

## AUTO DEFROST

### NOTE:

This 3 stage automatic system will gently defrost foods. It starts at MED-HIGH power level to begin the defrosting action. It automatically reduces down to MED-LOW and then LOW in equal intervals of time to thoroughly defrost the food. The standing time is greatly reduced after defrosting. For some items, it is entirely eliminated.

### DO THIS ... THIS HAPPENS ...



1. Touch the AUTO DEFROST pad.

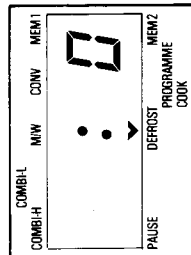

The "DEFROST" indicator light will light.

2. Touch the numeral pads for the desired defrosting time.

For example:



(10 minutes)

10:00 will show in the display.

**NOTE:** Time can be set up to 99 minutes and 99 seconds.

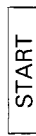

3. Touch the START pad.

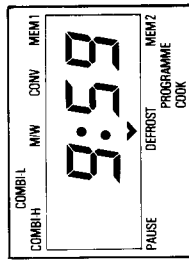

The oven will now start to Programme Defrost for 10 minutes. The "DEFROST" indicator lights will light on the display. The timer will start counting down in seconds.

**NOTE:** As time decreases, the power levels automatically change to MED-LOW and then LOW in equal amounts of time.

4. Three beeps will sound at the end of the defrosting time. The indicator lights will go off. The display panel will return to the time of day. The oven light will turn off and the turntable will stop turning.

## GRILLING

### NOTE:

- (1) Grilling in this oven is similar to conventional grilling. The heating element is located in the top of the oven.
- (2) It is recommended that a 10 minute pre-heat of the oven is given to give optimum cooking results.

### DO THIS . . .

GRILL

1. Touch the GRILL pad.

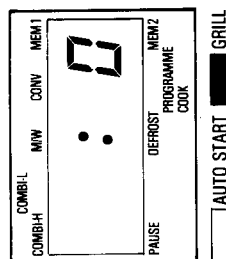

The "GRILL" indicator light will light up on the control display.

### THIS HAPPENS . . .

2. Touch the numeral pads for the desired cooking time.

### For example:

(25 minutes)

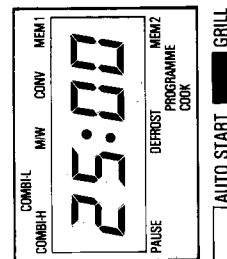

25:00 will show in the display.

**NOTE:** Time can be set up to 30 minutes.

3. Touch the START pad.

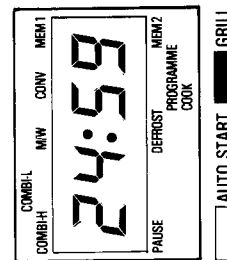

The oven will now start to grill for 25 minutes.

The "GRILL" indicator lights will light on the control panel. The timer will start counting down in seconds.

4. Three beeps will sound at the end of the cooking time. The indicator lights will go off. The display panel will return to the time of day. The oven light will turn off and the turntable will stop turning.

## GRILLING

**EXAMPLE:** To Grill hamburgers, steaks, kebabs, etc., use the trays this way:

METAL RACK

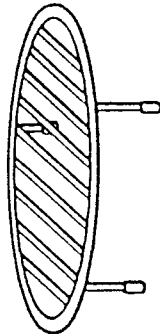

### To use:

- Place food on Metal Rack.
- Place the Metal Rack directly on the Turntable.

**NOTE:** When using Grill mode.

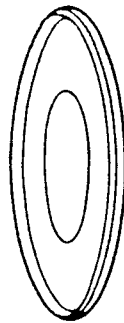

TURNTABLE

### TIPS:

- Coat the Metal Rack with a vegetable coating spray for easy cleaning afterwards.
- While Grilling, be careful as the trays will be hot to the touch. Use oven mitts or pot holders, while handling trays.
- While Grilling meats, be careful when removing the trays from the oven, as hot grease may have accumulated on the turntable.
- Never touch the oven window or metal interior of the oven when adding or removing food. The temperature inside the oven and door is quite high.
- Do not open the door too often, the temperature inside the oven decreases and the cooking may not be complete in the set time.

## FAN ASSISTED CONVECTION COOKING

### NOTE:

- This oven can be set to a minimum temperature of 100°C and a maximum temperature of 250°C.
- There is no pre-heating of the oven for convection cooking. Place food inside the oven when setting the controls.

### DO THIS . . .

CONVECTION

1. Touch the CONVECTION pad.

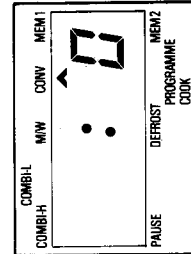

The "CONV" indicator light will light.



## Key Contacts

### **After Sales Service**

Over 1100 trained specialists, directly employed by us, ensure that you have complete confidence in both the appliances and services we offer.

#### **Repair Service**

UK: 08709 066 066

(Open 8 to 8 Mon - Fri, 8 to 6 Sat & 10 to 4 Sun)

[www.theservicecentre.co.uk](http://www.theservicecentre.co.uk)

Republic of Ireland: 1850 302 200

Note: Our Service Operators will require the following information:

Model Number

Serial Number

#### **Extended Warranties**

UK: 08709 088 088

(Open 8 to 6 Mon - Fri)

[www.theservicecentre.co.uk](http://www.theservicecentre.co.uk)

Republic of Ireland: 1850 502 200

#### **Genuine Parts and Accessories**

UK: 08709 077 077

(Open 8-30 to 5-30 Mon - Fri, 8-30 to 12 Sat)

[www.theservicecentre.co.uk](http://www.theservicecentre.co.uk)

Republic of Ireland: (01) 842 6836

General Domestic Appliances Limited, Morley Way, Peterborough, PE2 9JB

## Free Manuals Download Website

<http://myh66.com>

<http://usermanuals.us>

<http://www.somanuals.com>

<http://www.4manuals.cc>

<http://www.manual-lib.com>

<http://www.404manual.com>

<http://www.luxmanual.com>

<http://aubethermostatmanual.com>

Golf course search by state

<http://golfingnear.com>

Email search by domain

<http://emailbydomain.com>

Auto manuals search

<http://auto.somanuals.com>

TV manuals search

<http://tv.somanuals.com>