

*FULL INSTRUCTIONS FOR
INSTALLING AND OPERATING
YOUR HOTPOINT DOUBLE OVEN*

MODEL

BD52

BD62



Before you operate your new Hotpoint Double Oven

Please read these instructions fully.

ENSURE THAT THE OVEN IS INSTALLED BY A QUALIFIED ELECTRICIAN FOLLOWING THE INSTRUCTIONS BELOW.

1. Your oven should **not** be located adjacent to a gas hob/heater or eye level grill as flames from the burners could cause damage to your oven.
2. For your own safety and to get the best results from your oven it is important to read through this Handbook **before** using your oven for the first time including the Always and Never on pages 8 and 9.

Electrical Requirements

- For your own safety, we recommend that your cooker is installed by a competent person – such as one who is registered with NICEIC (National Inspection Council for Electrical Installation Contracting). The cooker should be installed in accordance with the latest Edition of the IEE Regulations.

WARNINGS

- **INCORRECT INSTALLATION COULD AFFECT THE SAFETY OF THE OVEN.**
- **THIS APPLIANCE MUST BE EARTHED.**
- **BEFORE CONNECTING OR INSTALLING THE OVEN THE ELECTRICITY SUPPLY MUST BE SWITCHED OFF.**

- **THE INSTALLER MUST** check that the voltage shown on the rating plate corresponds with the house electricity supply.
- The oven must be supplied via a suitable double pole isolating switch, having a contact separation of at least 3 mm in all poles placed in a readily accessible position adjacent to the unit.
- The maximum loading for your oven is 5.3kW.
- If the oven is to be wired into a connector unit this may be positioned behind the oven provided the following requirements are met:
 - i) The connector unit must not project from the wall more than 25 mm.
 - ii) The top of the connector must not be more than 350 mm above the base of the oven recess.
- After unpacking the oven stand it on the packing base in order to avoid damage.

Electrical Connections

- Remove the terminal cover at the rear base of the oven. Pass the cable through the cable clamp and connect to the appropriate terminals provided. Allow sufficient cable so that the oven can be set down on the floor whilst still connected up. Tighten the screws on the cable clamp and replace the terminal cover. Make mains connections.

This appliance conforms to EN55014 regarding suppression of Radio and Television reception interference.

Where a double oven is used a 32 amp double pole control switch should be used to feed the unit using a suitable rated cable. We recommend that a minimum of 4mm² PVC insulated twin and earth cable conforming to B.S. 6004.
- Where a hob is fitted adjacent to an oven then a 45 amp Double Pole control switch should be used to feed both units via separate suitably rated cables. We recommend that a minimum of 4mm² PVC insulated twin and earth cable conforming to B.S. 6004.

WARNING: CHILDREN SHOULD NOT BE ALLOWED TO PLAY WITH THE APPLIANCE OR TAMPER WITH THE CONTROLS.

PLEASE READ THIS BOOKLET CAREFULLY.

Contents	Page
Before you operate your new Hotpoint Double Oven	2
Electrical Requirements	2
Installation Instructions	4-7
For Your Safety - Always	8
Never	9
The main parts of your Double Oven	10
The cooking systems in your Double Oven	11
Before using your Oven for the first time	12
Temperature Conversion Scale	12
Controls	13-14
The Automatic Oven Timer	15-20
Grilling	21-22
Top Oven - Conventional Cooking	23
Top Oven Temperature Charts	24-25
Main Oven - Fan Grilling	26
Main Oven - Fan Grilling Roasting Chart	27
Main Oven - Fan Only	28
Main Oven - Conventional and Fan oven	29
Main Oven - Fan Oven Cookery Notes	30-33
The Slow Cook Setting	34-35
Half Grill / Full Grill	36
Menus	37-43
Care and Cleaning	44-46
If Something Goes Wrong	47-48
Hotpoint Service Cover	49
Key Contacts	Back Cover

Retention of this Instruction Book

This Instruction Book must be kept handy for reference as it contains important details on the safe and proper use of the appliance.

If you sell or pass the appliance to someone else, or move house and leave it behind, make sure this Book is also provided so the new owner can become familiar with the appliance and safety warnings.

If the Book is lost or damaged a copy may be obtained from General Domestic Appliances Ltd, Morley Way, Peterborough, PE2 9JB.

When first using the cooker ensure that the room is well ventilated (e.g. open a window or use an extractor fan) and that persons who may be sensitive to the odour avoid any fumes. It is suggested that any pets be removed from the room until the smell has ceased. This odour is due to temporary finish on oven liners and elements and also any moisture absorbed by the insulation.

Installation Instructions

Ensure that the electricity supply is turned off before installing your appliance.

**IMPORTANT
DO NOT LIFT OVEN BY THE
DOOR HANDLES.**

This equipment is designed specifically for domestic purposes and Hotpoint Limited cannot accept responsibility if used for any other type of application.

All electrical installations must be carried out by a NICEIC registered installer.

**WARNING: THIS APPLIANCE
MUST BE EARTHED.**

1. General

The appliance is designed for mounting at a safe level into an open housing which must be secured to the backing wall.

2. Oven Unit Housing Cabinets

- a. The oven unit housing cabinet dimensions must comply with Fig. 4. (See page 7.)
- b. An air gap of 50 mm minimum must be provided at the rear of any top or bottom cupboards or shelves. (See Fig. 1 page 6.)
- c. Ventilation must be unobstructed, ie. from adjacent cabinetry. This can be done by either raising the base of the cabinets using the adjusting feet (or spacers) or alternatively by providing a slot in the cabinet plinth to the dimensions shown overleaf.
- d. The air gap at the rear allows the warmed air to pass out of the inner cabinet space, but where it is intended to fit

cupboards above the oven unit to ceiling height it is essential that the warmed air is exhausted through the front of the cabinet Fig. 1. (See page 6.)

- e. If an oven unit is installed adjacent to a tall cabinet, steam escaping from the oven when the door is opened could condense on, and perhaps stain, the adjacent surface. To prevent permanent staining, the adjacent surface should be made of a material that is heat resistant and easy to clean. Adjacent tall cabinets should not be deeper than the oven housing cabinet.

IMPORTANT

It is essential that the lower cupboard is constructed in the manner illustrated see pages 6 and 7 ie. having side, back and roof panels so joined as to provide no apertures which could permit access to the oven unit when installed .

3. Final Installation

- a. Using a spirit level, check that the housing cabinet is level from side to side and from front to back in its installed position.
- b. Correct any unevenness by placing wooden packing under the bottom of the cabinet. Make sure that the cabinet rests firmly on the cabinet floor without rocking
- c. Before the oven is fitted, the cabinet must be firmly secured to the backing wall for stability.

Installation Instructions

- d. The oven unit should now be lifted (by 2 adults) into the cabinet and pushed fully home.
- e. Finally the oven unit must be secured to the cabinet by means of the four pozi wash head screws, two through each side trim.
- f. **REMOVE ALL PACKING MATERIAL FROM THE GRILL AND OVEN INTERIOR.**

List of Loose Items

4 x Pozi Wash Head No. 6 x 15mm screws.

Installation Instructions (cont'd)

Fig. 2

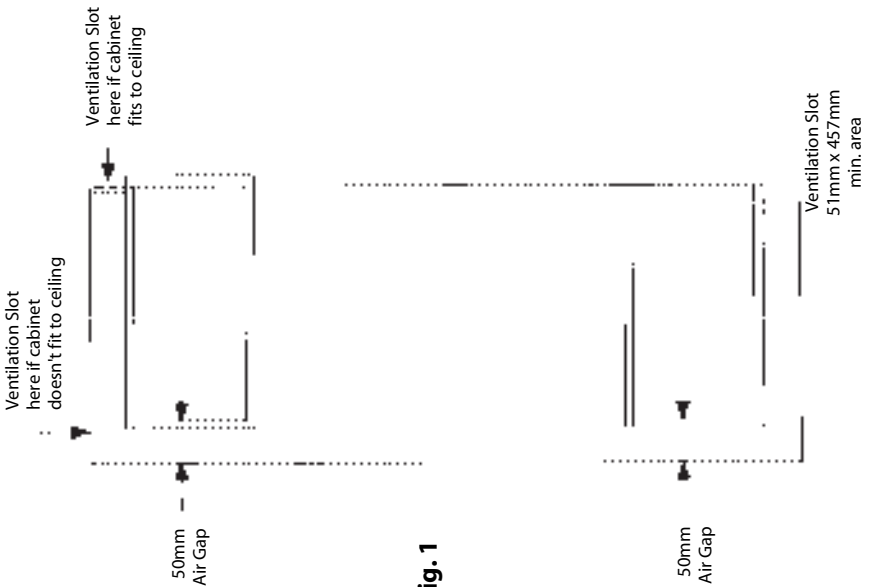
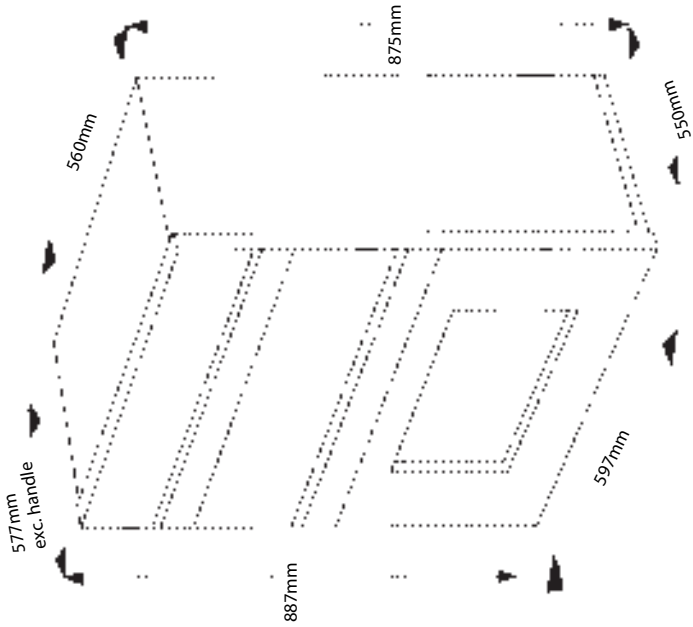
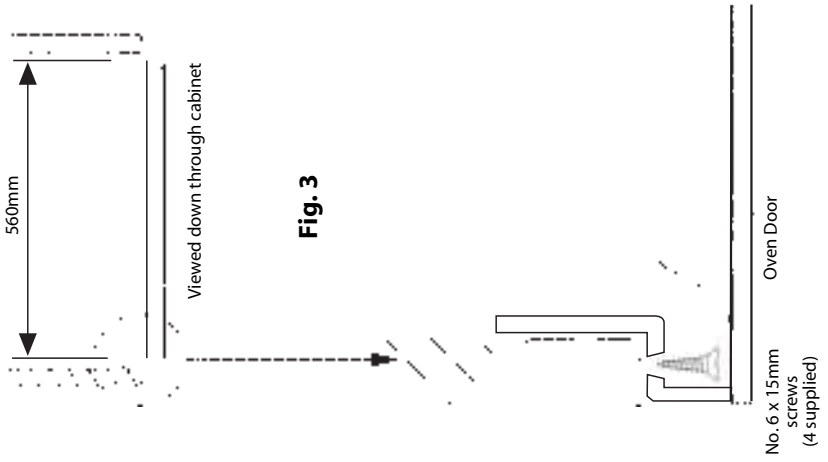
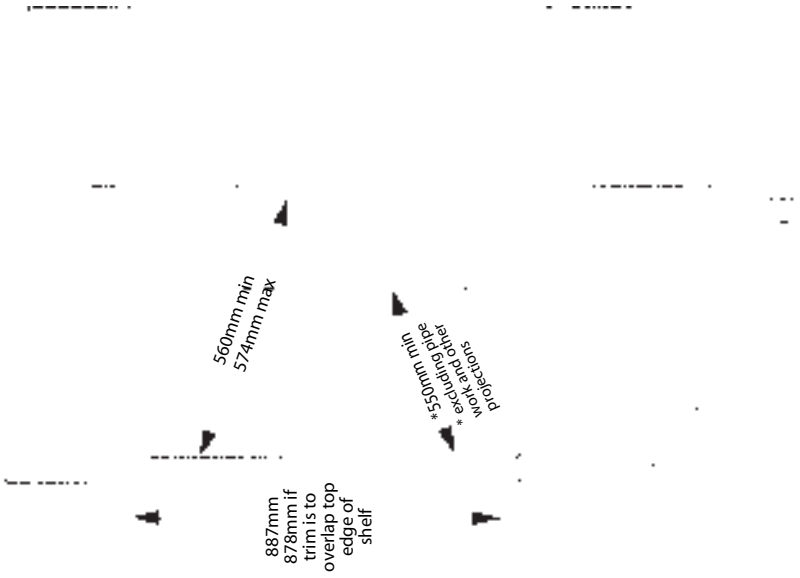

Fig. 1

Fig. 4



For Your Safety, Always ...

Please read through before operating your appliance.

- ALWAYS** Have your appliance installed by a competent engineer or electrical contractor.
- ALWAYS** Ensure the appliance has been properly earthed.
- ALWAYS** Remove all transportation packing from inside the oven/grill before switching on for the first time.
- ALWAYS** Make sure you understand the controls prior to using them.
- ALWAYS** Keep children away from the oven at all times when oven/grilling as surfaces will get extremely hot.
- ALWAYS** Remember that the oven and utensils will be very hot when in use.
- ALWAYS** Take care when opening the door. Let the steam and hot air escape before removing the food.
- ALWAYS** Use dry quality oven gloves for removing hot food utensils from the oven/grill.
- ALWAYS** Select the correct shelf position before turning the oven or grill on.
- ALWAYS** Turn off the electricity supply at the wall switch before cleaning.
- ALWAYS** Ensure poultry is thoroughly defrosted before cooking well.

- ALWAYS** Check all controls on the appliance are switched off before retiring to bed or after use.
- ALWAYS** Keep ventilation slots clear of obstructions.
- ALWAYS** Reset the oven timer to Manual after completing an Automatic Cooking Programme.
- ALWAYS** Take care on warm days when using the oven for delayed automatic cooking as certain foods can spoil.
- ALWAYS** Use a thick cloth to protect your fingers when replacing the oven lamp.
- ALWAYS** Refer servicing to a qualified appliance service engineer.
- ALWAYS** Follow the guide lines for successful defrosting when using the fan only mode.

For Your Safety, Never ...

- NEVER** Leave children playing unsupervised where the oven is installed and in use.
- NEVER** Attempt to grill with the grill/oven oven door closed.
- NEVER** Allow children to sit or stand on any part of the appliance.
- NEVER** Store food stuffs in the same cabinet as the oven.
- NEVER** Store items above an oven that children may attempt to reach.
- NEVER** Operate the oven with the inner glass panel removed.
- NEVER** Remove the oven shelves when the oven is hot.
- NEVER** Use water to extinguish oil or fat fires.
- NEVER** Use the oven/grill as a space heater.
- NEVER** Cover oven interior and shelves with aluminium foil.
- NEVER** Heat up unopened food containers as pressure can build up causing the container to burst.
- NEVER** Attempt to clean the oven until the mains supply has been switched off and the oven is cool.
- NEVER** Defrost the meat and poultry by warming through in the oven.
- NEVER** Store any aerosols/flammable liquids etc. in adjacent cabinetry.
- NEVER** Store anything which might catch fire in or near the oven.
- NEVER** Operate the grill when the ovens are set to cook automatically.
- NEVER** touch any heating elements inside the oven, the appliance becomes hot during use.
- NEVER** Use steam cleaners.

The main parts of your Double Oven

WARNING: DO NOT TOUCH THE GLASS DOORS WHEN THE OVEN IS IN USE AS THESE AREAS CAN BECOME HOT.

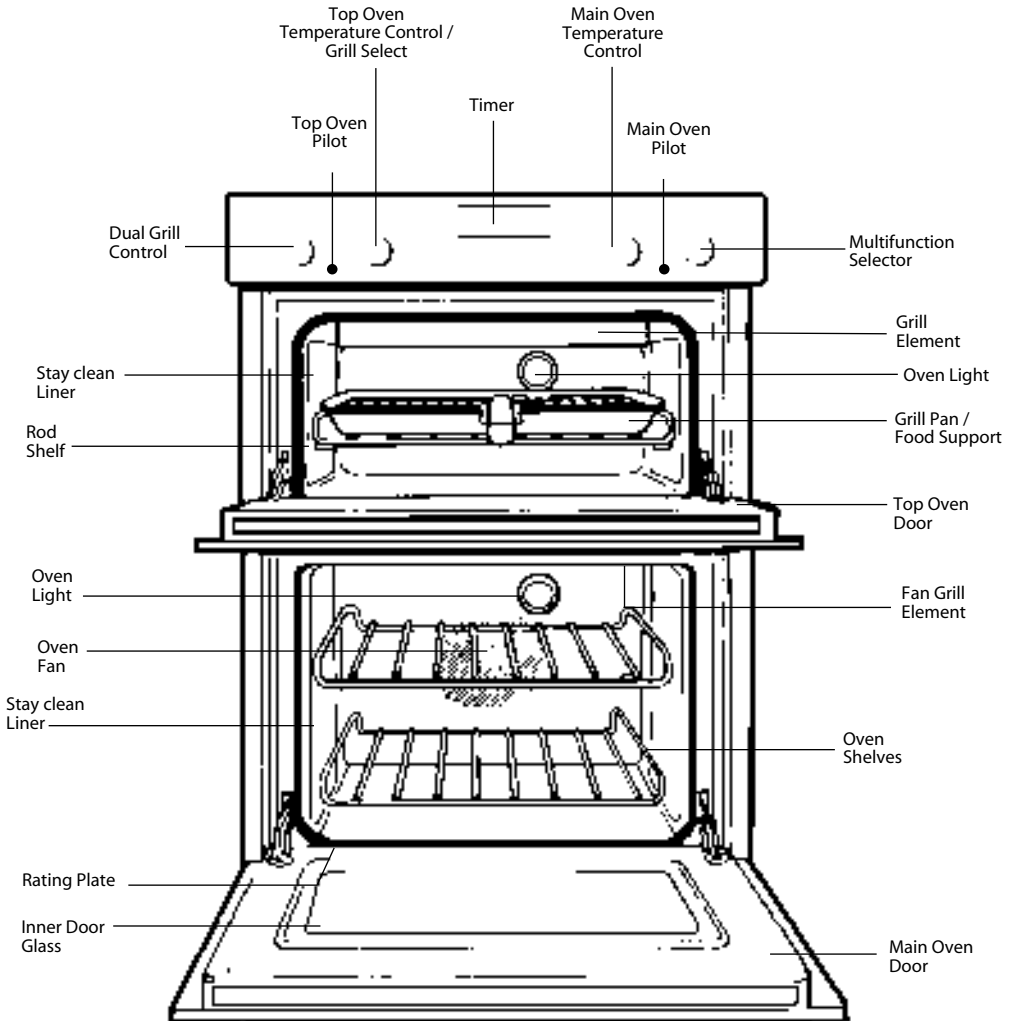

NEVER line the shelves, floor or sides of the oven or grill with aluminium foil as overheating and damage may result.

The Cooking Systems in your Double Oven

Your new oven is equipped with three different cooking systems:

1. **Conventional Heating (Top Oven)** - with upper and lower heat. This system is particularly suitable for roasting and baking on one shelf only.

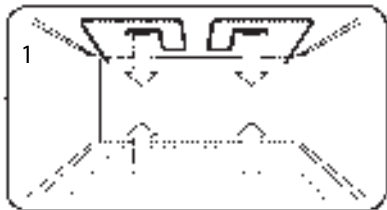

2. **Grilling (Top Oven)** - Has a full width, fully controllable grill. The grill also has an economy setting which enables you to use just the left section.

NOTE: The oven door should be open when grilling.
(See page 21.)

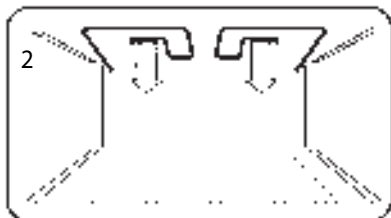

3. **Fan Cooking (Lower Oven)** - the fan oven operates by constantly blowing heated air from an element wrapped around the fan into the oven. This gives improved efficiency and, in general, enables the use of lower temperatures for cooking. It also means that there is less need to be particular about shelf positions and that you can bake at more than one level simultaneously (Batch Baking).

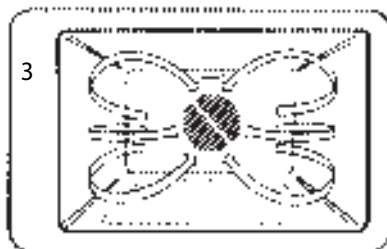

It should be noted that at the end of a cooking period there may be a momentary puff of steam when the oven door is opened. This will disperse in a few seconds and is a perfectly normal characteristic of an oven with a good door seal.

Before Using the Oven for the First Time

Make sure the electricity supply is switched ON.

Please note that when the double oven is used for the first time a slight odour may be emitted due to the 'burning off' of any temporary finish on oven fittings and elements and the removal of moisture absorbed by the lagging. The odour will cease after a short period of use.

To remove the 'new smell', heat up the empty oven for 30 minutes keeping the door closed. Ensure

that the room is well ventilated (eg, open a window or door) and that persons who may be sensitive to the odour avoid any fumes. It is suggested that any pets be removed from the room until the new smell has ceased.

Turn the selector switch to fan oven function, then turn oven thermostat to MAX. Also turn Top Oven/Grill selector to MAX.

The oven temperature thermostat lights will come on as well as the interior light, oven fan, control panel illumination, and cooling fan.

Temperature Conversion Scale

The chart below gives details of comparisons of oven settings for gas conventional ovens and fan oven in degrees °F and °C

GAS MARK	CONVENTIONAL OVEN		FAN OVEN
	°F	°C	°C
1/2	250	120	100
1	275	140	120
2	300	150	130
3	325	160	140
4	350	180	160
5	375	190	170
6	400	200	180
7	425	220	200
8	450	230	210
9	475	240	220

The Controls

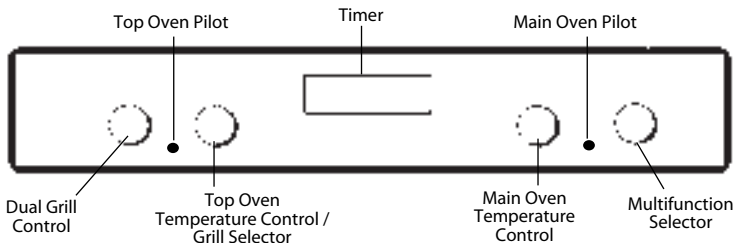

IMPORTANT

Before using your oven in the ordinary way, ALWAYS make sure that the timer has been set to MANUAL operation. Unless this is done, the main oven cannot heat up. Before seeking assistance, make sure this is done (refer to oven timer operation).

Multifunction Selector

Rotate the control knob in either direction until the required function symbol appears in the control window. Many of the functions will also require the main oven thermostat to be set before the oven will heat up.

Main Oven Temperature Control

This is used in addition to the multifunction selector. This is used for the functions: fan oven, fan grill, half grill and full grill and conventional oven.

Turn the control clockwise to set the oven thermostat to the required temperature.

If the timer is set correctly and the selector switch set to a suitable function an indicator light will illuminate. This will remain on until the oven reaches the required temperature. This light will then cycle on and off as the thermostat maintains control of the oven temperature.

Top Oven Temperature Control

Turn the control clockwise to set the top oven thermostat to the required temperature. An indicator light will illuminate. This will remain on until the oven reaches the required temperature. This light will then cycle on and off as the thermostat maintains control of the oven thermostat.

Grill Control

The grill control is designed to provide variable heat control of either both grill elements on together or the single left-hand grill element only. Turn the top oven control clockwise past the temperature settings to the half grill or full grill settings, depending on which you require. To set the grill power, turn the grill control to any setting 1-6. After use always return the controls to their off position "O".

Cooling Fan

A gentle flow of air will be blown below the control panel when any control is used. In some instances this will continue after switching off. This helps to keep the control panel and knobs cool.

After use Always return the controls to their off 'O' position.

Multifunction Selector Switch

The Multifunction selector switch is used when operating the main oven. With the exception of the **O** position the main oven light will remain on when this selector switch is used.

Off 

With the selector in this position the main oven will not heat up. The timer will still operate.

Fan Oven

The oven fan and a rear element are controlled when this function is selected.

Use the main oven thermostat control to set the required temperature.

Conventional Oven

Top and base elements are controlled when this function is selected.

Use the main oven thermostat to set the required temperature.

Half Grill

With this function selected only the left hand side of the grill will be on.

Use the oven thermostat control to set the required temperature.

Oven door must be open for grilling.

Full Grill

Both left and right hand grill elements will be on in this position.

Use the oven thermostat control to set the required temperature.

Oven door must be open for grilling.

Fan Grill

The oven fan and fan grill element are controlled when this function is selected.

Use the oven thermostat control to set the required temperature.

Oven door must be closed for fan grilling.

Fan Only

The oven fan will operate when this function is selected.

The oven thermostat control **must** be set in the **off** position.

Light Only

This function switches on the oven light only.

Oven Timer Operation

The oven timer offers you the following features:

1. Time of Day
2. Automatic Cooking
3. Minute Minder

Automatic Cooking

The main fan oven can be controlled automatically.

Guidance on automatic cooking

1. Select foods which will take the same time to cook.
2. Set the oven timer so that the food has just finished or is just about to finish cooking on your return to the oven. This will ensure the food has not cooled down and does not require reheating before serving.
3. Food should be as cold as possible when it goes into the oven, ideally straight from the refrigerator. Frozen meat and poultry should be thawed thoroughly before it is put in the oven.
4. We advise that warm food should never be placed in the oven if there is to be a delay period. Stews prepared by frying the meat and vegetables should be cooked as soon as possible.
5. We advise dishes containing left-over cooked poultry or meat, for example Shepherds Pie, should not be cooked automatically if there is to be a delay period.
6. Stews and joints should be cooked by the long slow method, so that the delay period is kept to a minimum.
7. On warm days, to prevent harmful bacterial growth in certain foods (ie poultry, joints, etc) the delayed start should be kept to a minimum.
8. Wine or beer may ferment and cream may curdle during the delay period, so it is best to add these ingredients just before serving.
9. Foods which discolour should be protected by coating in fat or tossing in water to which lemon juice has been added, prior to placing food in the oven.
10. Dishes containing liquid should not be filled too full to prevent boiling over.
11. Food should be well sealed (but not airtight) in a container to prevent the loss of liquid during cooking. Aluminium foil gives a good seal.
12. Ensure food is cooked thoroughly before serving.

Oven Timer Operation

CLOCKFACE

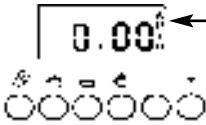



The timer incorporates a 24 hour clock.

Ensure the correct time of day is always set, before using your cooker.
PLEASE NOTE THAT THE DISPLAY WILL DIM BETWEEN 22.00 HOURS AND 06.00 HOURS TO PREVENT GLARE.

However, should you operate the timer during these hours the display will return to normal brightness for a few seconds and then dim again.

SYMBOLS

 will light up when you select a Minute Minder Period and will remain lit for the period set. At the end of the Minute Minder Period, the timer will emit an audible tone for 2 minutes, the  symbol will start to flash and will continue to flash until the Minute Minder function is cancelled.

 This "Cookpot" symbol will light up either:-

- When you press  the Cook Period Button and set a length of time for an Auto Cooking Programme. (It will go out again a few seconds after you release the timer buttons).
- During the actual Cook Period.

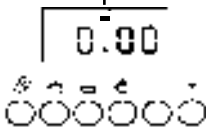

"AUTO" will light up:-

- When the timer is first turned on it will flash. (It will go out when a time of day is set.
- When an Auto Cooking Programme has been set.

The "Auto" symbol will flash at the end of an Auto Cooking programme to indicate that the programme has finished.

(When the "Auto" symbol is flashing, to return the oven to Manual operation, turn the oven controls off, ensure that the correct time of day is set, and press the "Manual" button twice - The "Auto" symbol will go out).

Note: If at any time the display shows a 'KEY' symbol, it is likely that the timer has been set incorrectly. OVEN COOKING IS NOT POSSIBLE. The 'KEY' symbol can be deleted and the cooker returned to manual operation by:

- Simultaneously pressing the Minute Minder and the Cook Period buttons for a period of approximately 8 seconds.
- Releasing the buttons and pressing the '+' button.

TIMER FUNCTION BUTTONS



Minute Minder Button

Here you can set a time period of up to 23 hours 59 minutes, that will count down. When it reaches zero, the timer will emit an audible tone.

For Example: If you set 20 minutes, the audible tone will occur 20 minutes later.

AUTO COOKING PROGRAMME



Cook Period Button

Cook Period is the actual length of time for which, the timer will switch the oven(s) on as part of an "Auto Cooking" programme.

(e.g. if you set 2 hours, the food will be cooked for 2 hours).



End Time Button

The time of day at which you want an "Auto Cooking" programme to **end**.

For Example: If you set a "Cook Period" for 2 hours, and "End Time" of 11:00. The timer will switch the oven(s) on at 9:00 and turn the oven(s) off at 11:00. You will hear a audible tone at 11:00, to indicate that the Auto Cooking Programme has finished.

Notes:

- When setting an Auto Cooking programme you will need to set the oven controls(s) to the required temperature(s) when you set the timer.
- If an Auto Cooking programme has been set the oven(s) will only operate during the pre-programmed time.



Manual Button

Needs to be pressed to cancel an Auto Cooking programme and return the oven(s) to Manual operation.

"+" and "-" Buttons Used to adjust the various timer function settings.

Oven Timer Operation

SETTING THE TIME OF DAY

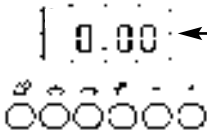

Step 1 Make sure all oven controls are turned Off.

Step 2 Check the electricity supply to the cooker is turned on.

Step 3 When switched on the display will show 0.00 and Auto symbol will be flashing intermittently.

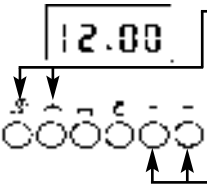

Step 4 Press & hold in both the & buttons together.

Step 5 With the & buttons still held in, press either the "+" or "-" buttons to set the correct time of day.

Step 6 Release all the buttons simultaneously.

THE TIME OF DAY IS NOW SET.

To change the time of day repeat Steps 4, 5 & 6 above.

Note: You cannot adjust the time of day if the timer has been set for an Auto Cooking Programme.

SETTING THE MINUTE MINDER

Step 1 Ensure the time of day is set correctly.

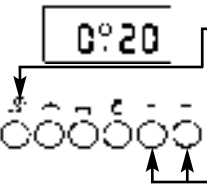

Step 2 Press and hold the button, a symbol will light up.

Step 3 With the button held in, set the required Minute Minder time using the "+" and "-" buttons.

Release all buttons and the timer display will revert back to the time of day. Bell symbol will remain lit to signify that a Minute Minder period has been set.

At the end of the set time a beeping sound will be heard, and the symbol will flash for approximately 2 minutes. After approximately 2 minutes the beeping sound will stop and the symbol will go out automatically.

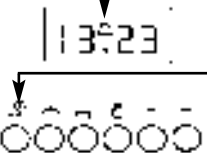

Step 4 To cancel the beeping sound within the two minutes press the button.

Note 1 When the Minute Minder has been set, the time remaining can be checked at any time by simply pressing the Minute Minder button.

Note 2 If necessary the Minute Minder can be cancelled before the tone sounds by pressing and holding the Minute Minder button and then at the same time pressing the "-" button until 0.00 appears in the display window.

Oven Timer Operation

AUTO COOKING PROGRAMMES

There are two Auto Cooking programmes that can be selected using your timer:-

- (a) To set the timer to switch the oven(s) On and Off Automatically
- (b) To set timer to switch on immediately and OFF automatically after a set cook period.

a) TO SET THE TIMER TO SWITCH THE OVEN(S) ON AND OFF AUTOMATICALLY

This allows you to cook at a specified time for a chosen period before the oven switches off Automatically.

- Step 1** Check that the correct time of day is set, if not follow instructions for setting the time of day.
- Step 2** Place food onto the correct shelf position in the oven and close the oven door(s).

Step 3 Press and hold in the button. The display will read 0.00 with the cookpot () symbol lit.

Step 4 With the button still held in, set the required Cook Period using the "+" and "-" buttons.

Release the buttons and the timer display will revert to the time of day with the Auto symbol and Cookpot () symbol lit.

Step 5 Press and hold in the button. The display will read the earliest possible end time for the Cook Period that you have set above. The Auto symbol and Cookpot () symbol lit.

Step 6 With the button still held in, use the "+" and "-" buttons to set the "End Time" (i.e. The time you require the oven to switch off).

Release all the buttons and the timer will revert back to the time of day.

The "Auto" symbol will remain lit to signify that an Auto Cooking Programme has been set. The () symbol will go out.

Step 7 Turn the oven control(s) to the required temperature, and if necessary select the appropriate oven function.

Note: If your appliance has two ovens: When the timer has been set for one oven it is possible to use the other oven only during the same Automatic programme.

At the end of the Automatic Cook Period the Auto Symbol will flash and an intermittent beeping sound will be heard. The beeping sound will continue for approximately 2 minutes unless cancelled. The "Auto" symbol will continue to flash until the timer is returned to Manual operation (see below).

Step 8 Press the button to cancel the beeping sound. (If 2 minutes has not elapsed).

Step 9 Turn the oven control(s) to the OFF position.

Step 10 Press the button again to return the oven(s) to Manual Operation. (The Auto symbol will go out)

Oven Timer Operation

Note 1 When cooking automatically the Cook Period can be checked at any time by simply pressing the Cook Period button.

Note 2 When cooking automatically the End Time can be checked at any time by simply pressing the End Time button.

b) TO SET TIMER TO SWITCH ON IMMEDIATELY AND OFF AUTOMATICALLY AFTER A SET COOK PERIOD

- Step 1** Check that the correct time of day is set, if not follow instructions for setting the time of day.
Step 2 Place food onto the correct shelf position in the oven and close the oven door(s).
Step 3 Turn the oven control(s) to the required temperature, and if necessary select the appropriate oven function.

Step 4 Press & hold in the button, the display will read 0.00 and the cookpot () symbol will light up.

With the button still held set the required Cook Period using the "+" and "-" buttons. Example: 1 hr 30 minutes (as shown).

Note: Cook Period is the length of time the food requires to cook.

Step 5 Release all buttons.

The timer display will revert to the time of day with the Auto symbol lit & Cookpot symbol remaining lit.

NOTE: The Cookpot symbol disappears

At the end of the Cook Period the "Auto" symbol will flash and an intermittent bleeping sound will be heard. The bleeping sound will continue for approximately 2 minutes unless cancelled. The "Auto" symbol will continue to flash until the timer is returned to Manual operation (see below).

Step 6 Press the button to cancel the bleeping. (If 2 minutes has not elapsed)

Step 7 Turn the oven control(s) to the OFF position.

Step 8 Press the button again to return the cooker to Manual operation. (The Auto symbol will go out).

Oven Timer Operation

TO CANCEL AN AUTO COOKING PROGRAMME BEFORE THE COOK PERIOD HAS FINISHED.

Step 1 Turn the oven control(s) to the OFF position.

Step 2 Press and hold in the button.

Step 3 With the button still held in, return the display to 0.00 by pressing the button.

Step 4 Release the and buttons and the display will revert to the time of day and the "Auto" symbol will flash.

Step 5 Press the button to return the oven(s) to "Manual" operation. The "Auto" symbol will go out.

Note 1 When cooking automatically the Cook Period can be checked at any time by simply pressing the Cook Period button.

OTHER NOTES ON TIMER OPERATION

- When cooking Automatically the Cook Period can be checked at any time simply by pressing the Cook Period button.
- When cooking Automatically the End Time can be checked at any time by simply pressing the End Time button.
- Having set a Cook Period and End Time an electronic device stores the information. The device within the timer will switch the oven(s) on and off at the required times.
- When setting an Auto Cooking Programme and a mistake is made, to clear:-
 - Press and hold in the button.
 - With the Cook Period button still held in, return the display to by pressing the button.
 - Release the & buttons, and the display will revert to the time of day and the "Auto" symbol will flash.
 - Press & release the button.
 - Start the sequence again.
- If at any time the display shows three flashing zero's 0.00. It is likely that the electricity supply to the oven has been interrupted. Reset the timer to the correct time of day.
Food in the oven may, therefore, not have been cooked, before serving check food is thoroughly heated and completely cooked.
- To set each function always press and hold the required function button and at the same time press "+" or "-" buttons.

Note: Between the hours of 22.00 & 06.00 the display dims to prevent glare. However, if you should operate a button during this period, the timer will return to normal brightness for a few seconds and then dim again.

Grilling in the Top Oven

Keep young children away from the appliance when the grill is in use as the surfaces get extremely hot.

Grilling should NOT be undertaken with the Grill/Top Oven door closed. (See below)

Never: Line the grill pan with aluminium foil.

The grill control provides variable heat control of the grill element and will only operate once the oven control has been set to a grill position (fully clockwise).

The grill regulator is designed to provide variable heat control of either the twin grill elements on together or the single left-hand grill element only, depending on which mode you select:

To select twin grill, first turn the Top Oven/Grill Selector clockwise to Full Grill.

The heat can now be adjusted by setting the grill regulator.

To select single grill turn the Top Oven/Grill Selector clockwise to Half Grill.

Food which requires browning only should be placed under the hot grill directly on the shelf in the first or second runner from the bottom of the oven, according to the depth of the dish.

Care should be taken when removing the grill pan during or directly after use.

After use, always return both controls anticlockwise to the **OFF** position.

NOTE: The grill pan must be cleaned after every use. Excess fat build up in the bottom of the pan could cause a fire hazard.

The heat can now be adjusted by setting the grill regulator.

Please note that the Grill will not operate unless the Top Oven/Grill Selector is in a grill position. After use, turn both controls ANTI-CLOCKWISE to their off positions.

Grill Procedure

Ensure oven timer is set to Manual.

Pre-heat the grill at setting 6 for approximately 1 minute.

When toasting/grilling, the rod shelf is placed in either the first or second runner position from base. The grill pan is placed on the shelf and pushed back as far as possible to correctly position it under the grill element. Leave the control at 6 for toast, and for sealing and fast cooking of foods. For thicker foods requiring longer cooking, turn the switch to a lower setting after the initial sealing on both sides at 6. The thicker the food, the lower the control should be set.

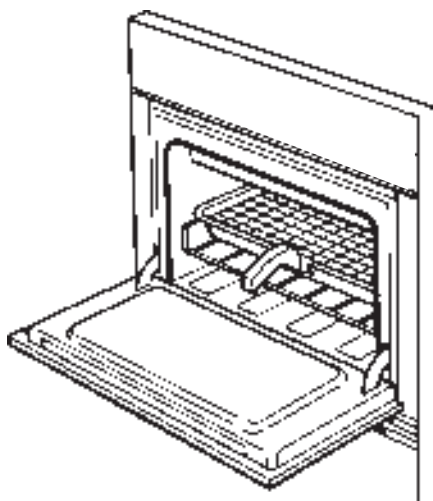

Fixing the Grill Pan Handle

Fix the grill pan handle securely in position before use.

The grill pan handle is detachable from the pan, to facilitate cleaning and storage.

The handle fits onto the grill pan edge with the small recess, Fig. 5.

Tilt the handle over the recess and slide it towards the centre, Fig. 6
Ensure the handle is fully located Fig. 7.

Insert the washer and fixing screw and tighten fully to ensure handle is secured .

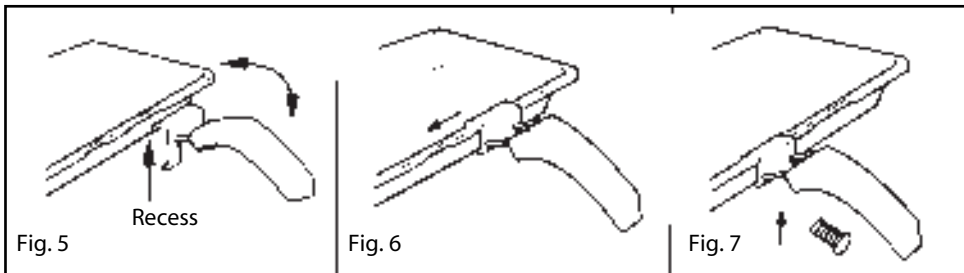

Always fit the screw prior to use.

Cooking in the Top Oven – Conventional Cooking

The Top Oven can be used to cook small quantities of food or used in conjunction with the Main Oven to provide additional cooking space so often necessary when entertaining.

The oven is designed so that the grill element operates at a reduced heat output (element will not glow), combined with a heating element situated underneath the floor of the oven.

Do not place items directly onto the floor of the oven.

To ensure even cooking of the food it is important that cooking utensils are positioned correctly on the oven shelf directly beneath the element. (As a guide, the front of the utensil should be approximately 100 mm/4 in from the front of the shelf.)

There are two cooking positions, the shelf placed on runner 1 or 2 (from the base).

Food or utensils must never be placed directly on the floor of the oven.

There should always be at least 25mm (1 in) between the top of the food and the grill element.

Do not use utensils larger than 300mm x 230mm (12in x 9in).

Larger utensils should be used in the Main oven.

Operation

To heat the oven, turn the Top Oven/Grill Selector clockwise, selecting the required temperature between 100°C (200°F) and 220°C (425°F) as recommended in the Top Oven Temperature Charts. The Top Oven indicator light will immediately come on and remain on until the oven

reaches the required temperature. The indicator light will then automatically go off and on during cooking as the thermostat maintains the correct temperature. If the indicator light doesn't come on when the control knob is turned, check that the oven timer is set to Manual as described in 'Oven Timer Operation'.

Cooking Meat/Poultry in the Top Oven

The Top Oven is most useful for the longer slower cooking required for cheaper cuts of meat – casserole cooking, pot roasting, braising etc. Small joints of meat up to 1.5 kg (3 lb), or poultry, up to 3.6 kg (8 lb) in weight can be roasted in a small meat pan in the Top Oven, but should preferably be 'slow roasted' or covered with a lid of aluminium foil (one or two incisions in the top of the foil will allow the meat or poultry to brown).

Larger joints of meat, and poultry weighing more than 3.6 kg (8 lb), should be roasted in the Main Oven.

Do not use the Main Oven meat pan or the grill pan as a meat pan in the Top Oven as air circulation will be seriously restricted.

Top Oven as a Warming Compartment for Plates and Dishes

Place the plates and dishes on the shelf that has been positioned on runner 1 of the oven and turn on the Top Oven thermostat to 100°C for 10-15 minutes.

DO NOT use the grill control.

Oven Temperature Charts – Baking

Baking	Top Oven Cooking				Fan Oven Cooking		
	Pre-heat	Temperature °C	Time in mins.	Position in Oven	Pre-heat	Temperature °C	Time in mins.
Scones	Yes	210/220	10-15	Runner 1 from bottom of oven.	Yes	210/220	8-10
Small Cakes	Yes	180/190	20-25	Runner 1 from bottom of oven.		170/180	15-20
Victoria Sandwich	Yes	170/180	20-30	Runner 1.		160/170	20-25
Sponge Sandwich (fatless)	Yes	180/190	20-25	Runner 1 from bottom of oven.	Yes	170/190	15-20
Swiss Roll	Yes	200/210	10-15	Runner 1 from bottom of oven.	Yes	180/200	12-15
Semi-rich Fruit cakes	Yes	150/160	60-75 7 inch	Runner 1.		140/150	75-90
Rich Fruit Cakes	Yes	140/150	Time Dependent on size	Runner 1.		130/140	Depending on size
Shortcrust Pastry	Yes	190/200	Time Dependent on recipe	Runner 1 from bottom of oven.		190/200	45-50
Puff Pastry	Yes	200/210	Time Dependent on recipe	Runner 1 from bottom of oven.		190/200	Dependent on use
Yorkshire Pudding	Yes	190/200	30-40	Runner 2 from bottom of oven.	Yes	180/190	40-45
Individual Yorkshire Puddings	Yes	200/210	20-30	Runner 2 from bottom of oven.	Yes	190/200	20-25
Milk Pudding	Yes	140/150	90-120	Runner 1.		130/140	105-135
Baked Custard	Yes	150/160	40-50	Runner 1.		140/150	40-50
Bread	Yes	200/210	30-45	Runner 1.	Yes	200/210	45-50
Meringues	Yes	100	150-180	Runner 2 from bottom of oven.	No	80-90	180-240

Note: If soft margarine is used for cake making, temperatures recommended by the manufacturers should be followed. Temperatures recommended in this chart refer to cakes made with block margarine only.

Oven Temperature Charts – Meat

Meat		Top Oven Cooking			Fan Oven Cooking			
Meat	Pre-heat	Temperature °C	Time (approx.)	Position in Oven	Meat	Pre-heat	Temperature °C	Time (approx.)
Beef/ Lamb (slow roasting)	Yes	170/180	35 mins per 450g (1 lb) + 35 mins over.	Runner 1 from bottom of oven.	Beef	No	160/180	20-25 mins per 450g (1lb) + 20 mins extra
Beef/ Lamb (foil covered)	Yes	190/200	35-40 mins per 450g (1 lb)		Lamb	No	160/180	20-30 mins per 450g (1lb) + 25 mins extra
Pork (slow roasting)	Yes	170/180	40 mins per 450g (1 lb) + 40 mins over		Pork	No	160/180	25-30 mins per 450g (1lb) + 25 mins extra
Pork (foil covered)	Yes	190/200	40 mins per 450g (1 lb)		Veal	No	160/170	25-30 mins per 450g (1lb) + 25 mins extra
Veal (slow roasting)	Yes	170/180	40-45 mins per 450g (1 lb) + 40 mins over		Chicken/ Turkey up to 4kg (8 lb)	No	160/180	18-20 mins per 450g (1lb) + 20 mins extra
Veal (foil covered)	Yes	190/200	40-45 mins per 450g (1 lb)		Turkey 4 to 5.5kg (8 to 12 lb)	No		13-15 mins per 450g (1 lb) at 150/160°C allow 12 mins per 450g at 150°C
Poultry/Game (slow roasting)	Yes	170/180	25-30 mins per 450g (1 lb) + 25 mins over		Casserole Stews	No	140-150	1 1/2 - 2 Hrs
Poultry/Game (foil covered)	Yes	190/200	25-30 mins per 450g (1 lb)					
Casserole Cooking	Yes	150	2-2 1/2 hrs					

If using aluminium foil, never: 1. Allow foil to touch sides of oven. 2. Cover oven interior with foil. 3. Cover shelves with foil.

The most accurate method of testing the readiness of joints of meat or whole poultry is to insert a meat thermometer into the thickest part of a joint, or the thickest part of poultry thighs, during the cooking period. The meat thermometer will indicate when the required internal temp has been reached.

Beef - Rare: 60°C Lamb: 80°C Poultry: 90°C
 Medium: 70°C Pork: 90°C
 Well Done: 75°C Veal: 75°C

Main Oven – Fan Grilling

Fan grilling is a combination of heat from the grill element and the oven fan circulating the hot air around the food.

Joints of meat and poultry will be browned as if they were cooked on a rotisserie or spit but more economically as the door left closed.

If required, fan grilling can be timed using the Oven Auto timer. Follow the timer instructions before selecting fan grill and the required temperature.

If Manual fan grilling is required always ensure the timer is set to Manual.

Do not use the oven without the removable oven roof in position with its front flange facing downwards.

Operating Instruction

1. Open the oven door.
2. Select the correct shelf position, as stated in chart.
3. Turn the selector switch to the Fan grill position.
4. Turn the oven thermostat control to the required temperature (see Fan Grilling Roasting Chart).
5. Position the meat pan centrally under the grill elements.
6. Close the oven door.
7. After use always return both controls to the off position.
8. If the oven timer was used, reset to Manual.

As with the fan oven cooking there is no need to pre-heat the oven – yet another economy feature. Also you can cook more than one thing at a time – even up to 4 small chickens.

Temperatures

These will be similar to those used for the more traditional form of roasting but the guide will give you an indication of which temperature to set the Thermostat. But remember that because of the way the oven is heated this is a more economical way of roasting.

General Recommendations

Most types of meat and poultry cooked by this method will have an all over brownness and crispness on the outside. The only exceptions are very lean joints, such as veal, which, because of its low fat content, is better cooked using conventional heating.

1. Always place the pan on the shelf position recommended. (See Chart).
2. There is no need to preheat the oven before cooking and all fan grilling should be carried out with the oven door closed, this saves energy.
The cooking temperatures and times are calculated from a cold oven.
3. After rinsing and drying meat, place on the food roasting support rack over the pan supplied.
4. Position meat in oven as recommended in the roasting chart.
5. Fan grilling is ideally suited for cooking all types of poultry and larger joints of meat (e.g. stuffed, rolled joints and legs of pork and lamb). Results will be as if you had cooked the food on a rotisserie. If you use frozen meat or poultry it must be completely defrosted before it is cooked.
6. When cooking a joint always grill it with the fat side uppermost in order to crisp it. For bigger joints or where there is little bone, grill at the lower temperature given in the table and cook for a longer time per kg.
7. When cooking any type of poultry, start grilling the underside uppermost and turn breast uppermost about a third to halfway through the cooking period. If cooking stuffed poultry allow slightly longer cooking time.



pan with
food support
rack.

Main Oven - Fan Grilling Roasting Chart

Shelf positions are counted from the base upwards ie: lowest shelf position is 1.

Type of Meat or Poultry	Weight kg	Temp °C	Time (min/kg)	Plus Extra Time (mins)	Total Cooking Time (mins)	Tips
PORK Pork Chop - thick		170	25		Dependent on size	Season. Grill on shelf position 3. Turn over after 15 mins. Grill on shelf position 3 Turn after 15 mins. Score fat with sharp knife and rub on salt. Pork should always be thoroughly cooked. So overcook rather than undercook. Grill on shelf position 1.
Gammon Steaks		160	30		Dependent on size	
Pork - any type of joint	1.0	160-170	60-70	45	105-120	
	1.5	150-170	60-70	45	130-150	
	2.0	140-150	65-75	50	180-230	
	2.5 over 2.5	140-150 140	65-75 70-75	50 50	220-240 -	
LAMB Lamb chop - thick		170	25		Dependent on size	Season. Grill on shelf position 3. Turn over after 15 mins. Score fat. Season with pepper and rosemary. If you prefer the lamb pink choose the shorter time Grill on shelf position 1.
Lamb - any type of joint	1.0	160-170	30-40	45	78-88	
	1.5	160-170	35-40	45	90-110	
	2.0	150-160	35-45	50	120-140	
	2.5 over 2.5	150-160 150	40-45 45-50	50 50	150-170 -	
BEEF Beef - joints which have an outside layer of fat eg. Rib, Rolled, Sirloin	1.0 1.5 2.0 2.5 over 2.5	170-180 170-180 160-170 160-170 160	40-50 40-50 40-50 45-50 45-50	20 20 20 30 40	60-70 80-90 100-110 140-150 -	Season. If joint preferred rare grill for the shorter time. If preferred well done grill for the longer time. Grill on shelf position 1.
CHICKEN	1.0	180	30	30	60	Season and brush over with melted butter to give nicely browned skin. Grill on shelf position 1.
	1.5	180	30	30	75	
	2.0	170	35	30	100	
	2.5	170	35	30	115	
Chicken joints	over 2.5 less than 1kg each	160-170 180	40 30	30 30	- 60	Shelf 1.
	DUCK	1.5 2.0 2.5	180 180 180	30 30 35	30 30 30	75 90 115-130
GOOSE	up to 4 4-5	170-190 160-170	40 45	40 40	- -	Can be stuffed. Grill on shelf position 1
TURKEY	up to 5 6-8	170 150	- -	- -	150-165 165-175	Season and brush over with melted butter to give nicely browned skin. Grill on shelf position 1
GAME Grouse Partridge Pheasant	Any Any Any	170-180 170-180 170-180	30-50 40-50 40-50	- - -	- - -	Well hung meat will require less cooking time. grill on position 1.
Beefburgers	450g(lb)	170	25mins per 450g (lb)			Shelf 3.
Sausages	450g (lb)	170	25mins per 450g (lb)			Shelf 3. Prick sausages before cooking.
Bacon	450g (lb)	170	25mins per 450g (lb)			Shelf 3. Roll up bacon before cooking.
Mixed Grill		170			30	4 pieces of steak, sausages, chops, bacon, tomatoes & mushrooms. Cook sausages, chops, bacon for 10 mins. add steak, cook for further 20 mins. Tomatoes & mushrooms should be placed on trivet under roasting rack for total cooktime.

Main Oven - Fan Only

The oven has a fan only position, which can be used to assist defrosting by circulating unheated air around the food.

Time to defrost will depend on type and size of the food and the room temperature.

Operating Procedure

1. Turn the selector switch to the fan only position.
2. After use always return the control to the off position and close the oven door.

DO NOT turn the oven thermostat control on.

DO NOT defrost meat and poultry by warming the food through.

Foods ideally suited for fan defrosting (without heat) are those which are normally served cold, e.g. cream/cream cakes, butter cream filled cakes, gateaux, cheese cakes, iced cakes, quiches, pastries, biscuits, bread croissants, fruit and many delicate frozen foods.

If fish, meat and poultry are to be "fan only" defrosted then where possible the items should be thin e.g. fish fillets, peeled shrimp, cubed or ground meat, sliced meat, thin chops, steaks or liver.

The items should be placed so the maximum amount of surface area is exposed to the circulating air and turned regularly to ensure even defrosting.

Fan defrosting without heating is only suitable for meat and poultry joints up to a maximum weight of 1.8kg (4 lb).

It is important to wash both roast and cooking utensils before cooking immediately after defrosting.

It is vitally important to strictly adhere to the basic principles of food handling and hygiene to prevent the possibility of bacterial growth.

Main Oven - Conventional Oven

Important

NEVER line the shelves, the floor or the sides of the oven with aluminium foil as overheating and damage may result.

The oven is heated by elements at the top of the oven and underneath the floor of the oven.

Food should not be placed on the floor of the oven.

Do not use the oven without the removable oven roof in position with its front flange facing downwards.

Operating Procedure

1. Ensure Oven Timer is set to Manual.
2. Position rod shelf as recommended in the chart for food being cooked.
3. Position food centrally under grill element.
4. Turn the selector switch to the conventional oven position.
5. Turn the oven thermostat control to the required temperature setting (see oven temperature charts).
The oven light will remain on. The oven indicator light will remain on until the oven reaches the set temperature. This light will then automatically cycle on and off during cooking as the oven temperature is controlled.
6. After use always return both controls to the off position and close the oven door.

Main Oven - Fan Oven

Important

NEVER line the shelves, the floor or the sides of the oven with aluminium foil as overheating and damage may result.

The oven is heated by elements at the rear of the oven.

A fan at the rear of the oven operates to circulate heated air within the oven.

Do not use the oven without the removable oven roof in position with its front flange facing downwards.

Operating Procedure

1. Ensure Oven Timer is set to Manual.
2. Position rod shelf as recommended in the chart for food being cooked.
3. Turn the selector switch to the fan oven position.
4. Turn the oven thermostat control to the required temperature setting (see oven temperature charts).
The oven light will remain on. The oven indicator light will remain on until the oven reaches the set temperature. This light will then automatically cycle on and off during cooking as the oven temperature is controlled.
5. After use always return both controls to the off position and close the oven door.

Main Oven - Fan Oven Cookery Notes

Since a fan oven heats up more quickly, and generally cooks food at a lower temperature than a conventional oven, pre-heating the oven is often unnecessary. However, foods such as bread, scones Yorkshire pudding, do benefit from being placed in a pre-heated oven.

The charts are a guide only, giving approximate cooking temperatures and times. To suit personal taste and requirements, it may be necessary to increase or decrease temperatures by 10°C.

Because the fan oven cooks so efficiently, we recommend that when cooking any recipes not designed for a fan oven, you reduce the temperature by about 25°C and the time by about 10 minutes in the hour. If large quantities are being cooked it will be necessary to increase the cooking time somewhat to compensate for the extra oven load.

Unless otherwise indicated in the charts, food is placed in a cold oven, i.e. without pre-heating. If food is placed in an already hot oven, the suggested cooking time should be reduced, depending on the type and quantity of food being cooked.

It should be noted that at the end of a cooking period there may be a momentary puff of steam when the oven door is opened, this will disperse in a few seconds and is a perfectly normal characteristic of an oven with a good door seal.

Oven Positions

Since the distribution of heat in the fan oven is very even, most foods will cook satisfactorily on any shelf position, but the shelves should be evenly spaced:

To ensure even circulation do not use meat pans larger than 390 x 300mm (15ins x 12ins) and baking trays no larger than 330 x 255mm (13ins x 10ins), these should be positioned centrally on the oven shelf.

- Do not fit shelves upside down.
- Never use more than 3 shelves in the oven as air circulation will be restricted.
- Food or cooking utensils should not be placed on the floor of the oven.

To avoid unnecessary cleaning, rod shelves which are not in use should be removed from the oven.

Main Oven - Fan Oven Cookery Notes

Temperature and Time

The oven is provided with two shelves. A third is available as an optional extra, contact Genuine Parts & Accessories Hotline (see back page) for further information.

If three shelves are used to cook large quantities of food for home freezing or parties, it may be necessary to increase the cooking times given in the charts by a few minutes, to allow for the loss of heat due to the extra time taken to load the oven, and the larger mass of food.

Baking trays should allow an equal gap on all sides of the oven.

To prepare meat and poultry for Roasting in your Fan Oven

- (a) Wipe the meat or poultry, dry well and weigh it. Meat which has for been stored in a refrigerator should be allowed to come to room temperature before cooking, and frozen meat or poultry must be completely defrosted before placing in the oven.
- (b) The weight of any stuffing used should be added before calculating the cooking time.
- (c) Place meat/poultry in the main oven meat pan supplied with your cooker. Small joints weighing less than 1.75kg (3 1/2 lbs) should be roasted in a smaller meat pan/tin – or they may be ‘pot roasted’ – a small joint or a large meat pan causes unnecessary oven splashing and evaporation of meat juices.
- (d) Additional fat should not be added, except for veal, very lean meat or poultry which can either be ‘larder’ with fat bacon or brushed very sparingly with cooking oil or melted fat.

- (e) Beef, lamb, mutton and poultry may be dusted lightly with seasoned flour to give a crisp outer surface. The skin of duck and goose should be pricked to release excess fat during cooking, and the rind of pork should be scored, brushed lightly with oil, and rubbed with salt to give crisp crackling.
- (f) Meat and poultry wrapped in, or covered with a tent of aluminium foil will be juicy and tender. Roasting bags offer the same advantages. Always follow the manufacturer’s pack instructions, and remember to reduce the temperatures given for conventional ovens by approximately 25°C and the time by approximately 10 minutes per hour.
- (g) Potatoes for roasting only require to be brushed with cooking oil or melted fat.
- (h) It is not necessary to baste when roasting in an electric oven and stock or liquid should not be added to the meat pan since this only causes unnecessary soiling, steam and condensation.

Frozen Meat and Poultry

Joints of meat and whole birds should be defrosted slowly, preferably in a domestic refrigerator (allowing 5-6 hours per 450g, 1 lb), or at room temperature (allowing 2-3 hours per 450g, 1 lb).

Frozen meat or poultry must be completely defrosted before placing in the oven.

It is essential to wash thoroughly and cook meat and poultry immediately after defrosting.

Main Oven Temperature Chart

It is not necessary to pre-heat the fan oven before roasting. **Note:** Where times are stated, they are approximate only.

Conventional Oven				Fan Oven				
Meat	Pre-heat	Temperature °C	Time (approx.)	Position in Oven	Meat	Pre-heat	Temperature °C	Time (approx.)
Beef/ Lamb (slow roasting)	Yes	170/180	35 mins per 450g (1 lb) + 35 mins over.	Runner 3 from bottom of oven.	Beef	No	160/180	20-25 mins per 450g (1lb) + 20 mins extra
Beef/ Lamb (foil covered)	Yes	190/200	35-45 mins per 450g (1 lb)		Lamb	No	160/180	20-30 mins per 450g (1lb) + 25 mins extra
Pork (slow roasting)	Yes	170/180	40 mins per 450g (1 lb) + 40 mins over		Pork	No	160/180	25-30 mins per 450g (1lb) + 25 mins extra
Pork (foil covered)	Yes	190/200	40 mins per 450g (1 lb)		Veal	No	160/170	25-30 mins per 450g (1lb) + 25 mins extra
Veal (slow roasting)	Yes	170/180	40-45 mins per 450g (1 lb) + 40 mins over		Chicken/ Turkey up to 4kg (8 lb)	No	160/180	18-20 mins per 450g (1lb) + 20 mins extra
Veal (foil covered)	Yes	190/200	40-45 mins per 450g (1 lb)		Turkey 4 to 5.5kg (8 to 12 lb)	No	150-160 or 150	12-14 mins per 450g (1lb) at plus 12 mins extra *For every 450g (1lb) over 5.5kg (12lb) allow 10 mins per 450g (1 lb) and roast at 150 C
Poultry/Game (slow roasting)	Yes	170/180	25-30 mins per 450g (1 lb) + 25 mins over		Casserole Stews	No	140-150	1 1/2 - 2 Hrs
Poultry/Game (foil covered)	Yes	190/200	25-30 mins per 450g (1 lb)					
Casserole Cooking	Yes	150	2-2 1/2 hrs					

If using aluminium foil, never: 1. Allow foil to touch sides of oven. 2. Cover oven interior with foil. 3. Cover shelves with foil.

The most accurate method of testing the readiness of joints of meat or whole poultry is to insert a meat thermometer into the thickest part of a joint, or the thickest part of poultry thighs, during the cooking period. The meat thermometer will indicate when the required internal temp has been reached.

Beef -	Rare:	60°C	Lamb:	80°C	Poultry:	90°C
	Medium:	70°C	Pork:	90°C		
	Well Done:	75°C	Veal:	75°C		

Main Oven Temperature Chart

Note: Where times are stated, they are approximate only.

Baking	Conventional Oven				Fan Oven		
	Pre-heat	Temperature °C	Time	Shelf Position	Pre-heat	Temperature °C	Time
Scones	Yes	220	10-15 mins.	2nd from bottom	Yes	210/220	9-12 mins. approx.
Small Cakes	Yes	180	15-25 mins.	3rd from bottom	No	170/180	15-20 mins. approx.
Victoria Sandwich	Yes	160	20-30 mins.	3rd from bottom	No	160/170	20-25 mins. approx.
Sponge Sandwich (Fatless)	Yes	170/180	15-20 mins.	3rd from bottom	Yes	170/190	15-20 mins. approx.
Swiss Roll	Yes	190/200	8-12 mins.	3rd from bottom	Yes	180/200	12-15 mins. approx.
Semi-rich Fruit cakes	Yes	150/160	1 1/4 hrs. 7"	2nd from bottom	No	140/150	1 1/4 - 1 1/2 hrs. approx.
Rich Fruit Cakes	Yes	130/140	Depending on recipe and size	2nd or 3rd from bottom	No	130/140	Depending on size.
Shortcrust Pastry	Yes	180/190	Depending on use	2nd or 3rd from bottom	No	190/200	Depending on size.
Puff Pastry	Yes	190/200	Depending on use	2nd or 3rd from bottom	No	190/200	Depending on size
Yorkshire Pudding	Yes	190/200	40-45 mins.	3rd from bottom	Yes	180/190	40-50 mins. approx.
Individual Yorkshire Puddings	Yes	200/210	20-30 mins.	3rd from bottom	Yes	190/200	20-25 mins. approx.
Milk Pudding	Yes	140/150	1 3/4 - 2 hrs.	2nd from bottom	No	130/140	1 1/2 - 2 hrs. approx.
Baked Custard	Yes	130/140	40-50 mins.	3rd from bottom	No	140/150	35-45 mins. approx.
Bread	Yes	190/200	25-35 mins.	3rd from bottom	Yes	200/210	30-35 mins. approx.
Meringues	Yes	80/90	3 - 3 1/2 hrs.	3rd from bottom	No	70-90	3-4 hrs. approx.

Note: If soft tub margarine is used for cake making, we would recommend using the all in one method and to reduce the temperature by 10°C. Temperatures recommended in this chart refer to cakes made with block margarine or butter only.

The Slow Cook Setting

Your Multifunction oven has a 'slow cooking' facility.

This is used for slow cooking, keeping food warm and warming plates for short periods.

Some Advantages of Slow Cooking are:-

The oven stays cleaner because there is less splashing.

Timing of food is not as critical, so there is less fear of overcooking.

Fully loading the oven can be very economical.

Cooking times can be extended in some cases by up to 2hrs. for late comers.

Bearing in mind these advantages, it makes sense to cook larger quantities of food than required and store them in a freezer to be used cold or for re-heating.

It is important to follow the guidelines given for preparing food using the 'Slow' setting.

Slow cooking can only be used with the selector switch set to fan oven position and the oven temperature control to temperature setting 'S'.

Operating Procedure

1. Ensure Oven Timer is set to Manual.
2. Turn the selector switch to the fan oven position.
3. Turn the oven thermostat control to temperature setting S. The oven light will remain on.
The oven indicator light will remain on until the oven reaches the set temperature. This light will then automatically cycle on and off during cooking as the oven temperature is controlled.
4. After use always return both controls to the off position and close the oven door.

Using The Slow Cook Setting

Points to bear in mind when preparing food:-

1. Make sure all dishes will fit into the oven before preparing the food.
2. All dishes cooked by the Slow Cook setting should be cooked for a minimum of 6 hours. They will 'hold' at this setting for a further hour but marked deterioration in appearance will be noticed in some cases.
3. Joints of meat and poultry should be cooked at fan oven 170°C for 30 mins before turning to the Slow Cook setting.
4. Meat over 2.7 Kg. (6 lbs) and poultry over 2 Kg. (4 lbs 8oz) are unsuitable for the Slow Cook setting.
5. Always stand covered joints on a rack over the meat tin, to allow good air circulation.
6. Pork joints can only be cooked, if an internal temperature of at least 88°C is reached. This can be tested using a meat thermometer.
7. This method is unsuitable for stuffed meat and poultry.
8. Always bring soups, casseroles and liquids to the boil before putting in the oven.
9. When casseroles are used, cover the food first with foil and then the lid to prevent loss of moisture.
10. Always thaw frozen food completely before cooking.
11. Root vegetables will cook better if cut into small even sized pieces.
12. Always adjust the seasoning and thickenings at the end of the cooking time.
13. Egg and fish dishes need only 1-5 hours cooking and should be observed from time to time.
14. Dried red kidney beans must be boiled for a minimum of ten minutes after soaking, before inclusion in any dish.

Storage and Re-heating of Food

1. If food is to be frozen or not served immediately, cool it in a clean container as quickly as possible.
2. Thaw frozen food completely in the refrigerator before re-heating.
3. Re-heat food thoroughly and quickly either on the hotplate or in the fan oven, 170°C and then serve immediately.
4. Only re-heat food once.

Main Oven Grilling

DO NOT allow young children near the appliance when the grill is in use as the surfaces can get extremely hot.

GRILLING SHOULD NEVER BE UNDERTAKEN WITH THE DOOR CLOSED.

Do Not line the grill pan with aluminium foil.

Ensure that the grill pan is cleaned after every use. Excess fat build-up in the bottom of the pan could cause a fire hazard.

Preheat the grill on the required setting for 5 minutes

Door position for grilling:

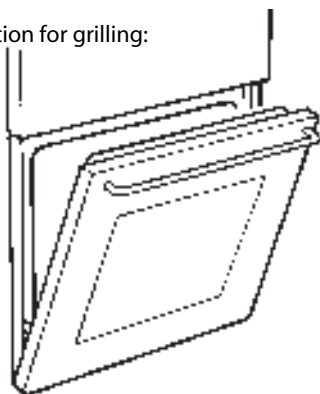

Grilling Procedure:

1. Open the oven door and position the rod shelf as recommended in the grilling chart (see below) for the food being cooked.
2. Turn the multifunction selector switch to Half Grill or Full Grill and then turn the Main Oven temperature control to the required setting to pre-heat for approximately 5 minutes.
3. Position the grill pan centrally under the grill element and push back as far as the location stops on the rod shelf.
4. Leave the oven thermostat at setting 230°C for toast and for fast cooking of foods. For thicker foods requiring longer cooking turn the thermostat to a lower setting, after initial sealing on both sides at 230°C. The thicker the food, the lower the thermostat should be set.
If excessive smoke is emitted, reduce the setting.
5. After use always return both controls to their OFF (O) position.

Food	Shelf Position from base of oven	Setting Required Temp °C	Cooking Time
Toasting of bread products	6	230	2-5 mins
Small cuts of meat, sausages, bacon etc.	5 or 6	230 for 4- 6 mins then reduce to setting 170	10-20 mins
Chips, gammon steaks etc.	5	230 for 6- 8 mins then reduce to setting 170	20-30 mins
Fish: Whole / Fillets Fingers	5 6	170 230	15-20 mins 10-15 mins
Pizza's	5	170	10-15 mins
Browning of food	5	230	5-10 mins

Menus

Menu 1

Leek and Potato Soup
Stuffed Peppers
Braised Red Cabbage
Summer Pudding

Method

Slow Cook for 6 hrs.

Leek and Potato Soup

450g (1 lb) Leeks, trimmed, washed and cut into rings
450g (1 lb) Potatoes, peeled, washed and thinly sliced
2 tablespoons vegetable oil
500ml (1 pint) hot vegetable stock
Salt and Pepper
250ml (1/2 pint) single cream
250ml (1/2 pint) milk

1. Prepare leeks and potatoes.
2. Fry leeks in oil until soft. Add potato slices and cook for 3 minutes.
3. Add stock and seasoning, bring to boil.
4. Transfer to large casserole dish, cover with foil and fit lid tightly. Place in oven.
5. At end of cooking, puree until thick and smooth.
6. Stir in cream and milk and re-heat gently, do not boil.

Stuffed Peppers

4 Peppers, washed
1 tablespoon vegetable oil
1 small onion, peeled and diced
4 mushrooms, wiped and sliced
1 courgette, sliced
2 tomatoes, peeled and chopped
50g (2 oz) long grain rice, cooked
Salt and Pepper

1. Cut tops of peppers, deseed and carefully remove stalks from tops.
2. Blanch in boiling water for 2 minutes, drain.
3. Heat oil in pan, cook onion until soft.
4. Add mushrooms, courgette and tomatoes, cook for 3-4 minutes.
5. Add rice and seasoning, cook for 2 minutes.
6. Place blanched peppers in casserole dish, divide vegetable mixture equally into the peppers. Put lids on peppers.
7. Cover dish tightly with foil and the lid.
8. Place in oven.

Menus

Menu 1 continued

225g (8 oz) onion, peeled and chopped
2 tablespoons vegetable oil
450g (1 lb) red cabbage, finely shred
225g (8 oz) cooking apple, peeled, cored and diced
225g (8 oz) pear, peeled, cored and diced
3 tablespoons brown sugar
1/2 teaspoon nutmeg
Salt and Pepper
3 tablespoon cider vinegar
Juice of 1 orange

Braised Red Cabbage

1. Place onion and oil in pan and cook for 3 minutes.
2. Add cabbage, apple and pear and cook for 3-4 minutes. Place in casserole dish.
3. Add remaining ingredients to pan and heat to boiling. Pour over vegetables.
4. Cover dish tightly with foil and lid.
5. Place in oven.

Summer Pudding

8-10 slices of bread, crusts removed
50g (2 oz) butter melted
50g (2 oz) demerara sugar
375g (12 oz) prepared fruit, eg. strawberries, raspberries etc.
50g (2 oz) caster sugar
2 tablespoons water

1. Grease a basin or souffle dish with butter and sprinkle with sugar.
2. Line with buttered and sugared bread, placing the buttered side towards the out side of the basin.
3. Pack firmly with fruit and add sugar and water.
4. Cover with buttered, sugared bread.
5. Cover dish with foil.
6. Place in oven.

Menu 2

Spring Vegetable Soup
Braised Topside au Poivre
Rhubarb and Raspberry Crunch Layer

Method

Slow Cook for 6 hrs..

Spring Vegetable Soup

3 medium sized carrots, peeled and sliced
2 medium sized onions, peeled and diced
2 sticks celery, cut into 1" pieces
15g (1/2 oz) butter
58g (2 1/4 oz) can tomato puree
2 vegetable stock cubes
Salt and Pepper
50g (2 oz) sliced green beans
100g (4 oz) shredded white cabbage
1 teaspoon cornflour, blended with a little cold water

1. Melt butter in pan, add carrots, onions and celery and fry gently for 3-4 minutes.
2. Stir in tomato puree, crumbled stock cubes, 1 litre (1 3/4 pints) water and seasoning.
3. Bring to the boil, transfer to large casserole dish.
4. Add remaining ingredients to dish, cover tightly with foil and lid.
5. Place in oven.

Menus

Braised Topside au Poivre

450g (1 lb) Topside of beef, cut into 4 slices
1 tablespoon black peppercorns, crushed
Salt
25g (1 oz) butter
2 tablespoons vegetable oil
4 small courgettes, thickly sliced
4 tomatoes, sliced
125ml (1/4 pint) red wine

1. Sprinkle beef with peppercorns and salt.
2. Heat butter and oil in frying pan, cook half the courgettes and tomatoes, place in bottom of casserole dish.
3. Fry meat on both sides and place on top of vegetables, then cook remaining vegetables and place on top of meat in casserole dish.
4. Add red wine to pan and bring to the boil. Pour into casserole dish.
5. Cover dish with foil and fit lid tightly.
6. Place in oven.

Rhubarb and Raspberry Crunch Layer

100g (4 oz) butter, melted
100g (4 oz) rolled oats
100g (4 oz) digestive or ginger biscuits coarsely crushed
50g (2 oz) mixed chopped nuts
175g (6 oz) demerara sugar, divided in half
Good pinch of cinnamon
450g (1 lb) rhubarb, cut into 2.5cm (1") lengths
225g (8 oz) frozen raspberries

1. Mix together butter, oats, crushed biscuits, nuts, half sugar and cinnamon.
2. In another bowl mix remaining sugar and fruits together.
3. Place half fruit in bottom of a 1.1 litre (2 pint) greased ovenproof dish. Sprinkle with half biscuit mixture.
4. Repeat layers.
5. Place in oven.

Menu 3

Chilli Con Carne

Rice

Fruit Crumble

675g (1 1/2 lb) minced beef
15ml (1 tbsp) vegetable oil
1 large onion, skinned and chopped
1/2 green pepper, seeded and chopped
2 x 425g (15 oz) can tomatoes, chopped
Salt and Pepper
1 tablespoon chilli powder
1 teaspoon brown sugar
2 tablespoons tomato puree
425g (15 oz) can red kidney beans, blended together

Method

Slow Cook for 6 hrs..

Chilli Con Carne

1. Fry minced beef in oil until lightly browned, add onion and pepper and fry for 5 mins, until soft.
2. Blend together chilli powder, brown sugar and tomato puree.
3. Stir in tomatoes, chilli paste and seasoning. Bring to boil.
4. Place in casserole dish.
5. Cover tightly with foil and lid.
6. Place in oven.

Menus

Menu 3 continued

10 oz (275g) long grain rice
3 tablespoons (45ml) oil
1 1/4pt (625ml) water

675g (1 1/2 lb) Fruit, prepared
75g (3 oz) Caster sugar
175g (6 oz) Plain flour
75g (3 oz) Butter
75g (3 oz) demerara sugar

Menu 4

Salmon Pate
Roast Lamb
Jacket Potatoes
Pear Pudding

450g (1 lb) cooked, or canned salmon,
pink or red
4 x 2.5 cm (1") thick slices of white
bread from large loaf
250ml (1/2 pint) milk
25g (1 oz) butter, softened
1 egg yolk
2 tablespoons chopped parsley
Juice of 1/2 lemon
Salt and Pepper

1.25 kg (2 1/2 lb) Leg of Lamb
1 teaspoon rosemary
1 tablespoon parsley, chopped
Salt and pepper
Bay leaf

Long Grain Rice

1. Wash the rice.
2. Fry the rice in oil until lightly browned.
3. Boil the water , add salt and place with rice in casserole dish.
4. Cover dish tightly with foil and lid.
5. Place in oven.

Fruit Crumble

1. Place prepared fruit and sugar in dish.
2. Rub butter into flour until it resembles fine breadcrumbs.
3. Stir in demerara sugar and mix well.
4. Sprinkle over fruit.
5. Place in oven.

Method

Slow Cook for 6 hrs..

Salmon Pate

1. If using canned salmon, drain. Flake salmon into bowl.
2. Break bread into small pieces and soak in milk for 5-10 mins, or until soft. Stir into fish
3. Add softened butter, egg yolk, parsley, lemon juice and seasoning. Beat together till thoroughly mixed.
4. Turn mixture into 500ml (1 pint) greased ovenware dish and cover with foil.
5. Place dish in larger dish containing 2.5 cm (1") of hot water.
6. Cover completely with foil. Place in oven, carefully.

Roast Lamb

} Mixed
together

1. Wipe meat. Place in piece of foil.
2. Season well with mixture and wrap tightly in foil.
3. Place on rack in dish.
4. Cook in oven at 170°C for 30 minutes before setting to 'Slow Cook'.

Menus

Jacket Potatoes

4 Large potatoes

1. Scrub the potatoes, prick well.
2. Wrap each potato in a piece of cooking foil.

Pear Pudding

50g (2 oz) butter } Melted
50g (2 oz) dark brown sugar } together
100g (4 oz) margarine
100g (4 oz) caster sugar
2 size 4 eggs
100g (4 oz) self raising flour, sieved
1/4 teaspoon almond essence
3 pears, peeled, cored and cut into 4

1. Coat base of souffle dish with melted butter and sugar.
2. Cream together margarine and sugar until light and fluffy.
3. Beat in each egg, fold in flour, and stir in almond essence.
4. Place prepared pear slices in base of dish then cover with cake mixture.
5. Cover dish tightly with foil.
6. Place in oven.

Menu 5

Rich Onion Soup
Honey Roast Ham
Ratatouille
Bread Pudding

Method

Slow Cook for 6 hrs.

Rich Onion Soup

450g (1 lb) onions, peeled and thinly sliced
25g (1 oz) butter
1 tablespoon vegetable oil
1 teaspoon salt
1/2 teaspoon brown sugar
40g (1 1/2 oz) plain flour
750ml (1 1/2 pint) brown stock
125ml (1/4 pint) stout or brown ale

1. Gently cook onions in butter and oil in large saucepan for 5 minutes.
2. Add salt and sugar and cook for 2 minutes.
3. Remove from heat and stir in flour, stock and beer.
4. Bring to boil. Place in casserole dish.
5. Cover tightly with foil and lid.
6. Place in oven.

Honey Roast Ham

2kg (4 1/2 lb) joint middle cut gammon
Sauce:
2 tablespoons honey
2 tablespoons sherry
1 tablespoons demerara sugar

1. Soak gammon in cold water overnight. Drain and dry.
2. Coat with sauce, wrap in foil.
3. Place in tin.
4. Cook on 180°C for 30 minutes. Add rest of meal to oven and set to 'Slow Cook' setting for 7 hrs.

Menus

Menu 5 continued

225g (8 oz) slightly stale bread
250ml (1/2 pint) milk
2 eggs
1 tablespoon brandy, optional
175g (6 oz) mixed dried fruit
40g (1 1/2 oz) demerara sugar
50g (2 oz) melted butter
1 teaspoon mixed spice
Finely grated rind of 1 lemon
Grated nutmeg
Caster sugar

Spiced Bread Pudding

1. Grease shallow ovenproof dish. Line base with greased greaseproof paper.
2. Cut bread into very small pieces.
3. Bring milk to boil and pour over bread. Add pinch of salt, allow to stand for about 20 mins or until pulped.
4. Lightly beat eggs and stir into bread mixture with brandy, dried fruit, sugar, butter, mixed spice and lemon rind. Mix well together.
5. Turn mixture into prepared dish. Sprinkle with little nutmeg and caster sugar.
6. Place in oven.

Ratatouille

375g (12 oz) aubergines
Salt
225g (8 oz) onions, peeled and sliced
1-2 cloves of garlic, crushed
2 tablespoons vegetable oil
375g (12 oz) tomatoes, skinned and roughly chopped
375g (12 oz) courgettes, sliced
375g (12 oz) red peppers, de-seeded and sliced
Bunch of fresh herbs
Salt and pepper
Chopped parsley

1. Slice aubergines and sprinkle with salt, leave for 30 mins, pat dry.
2. Cook onions gently with garlic, in oil until soft.
3. Add remaining ingredients, and heat thoroughly.
4. Place in casserole dish.
5. Cover tightly with foil and lid.
6. Place in oven.

Menu 6

Tomato Soup
Fruity Chicken Casserole
Rice Pudding

1 medium sized onion, peeled and chopped
15ml (1 tbs) vegetable oil
675g (1 1/2 lb) tomatoes, roughly chopped
500ml (1 pint) vegetable stock
Salt and pepper
5ml (1 level tsp) caster sugar

Method

Slow Cook for 6 hrs..

Tomato Soup

1. Fry onion gently in oil until soft.
2. Add tomatoes, stock, seasoning and bring to boil.
3. Place in casserole dish cover with foil and lid and place in oven.
4. Before serving, sieve soup.
5. Reheat, adjust seasoning if necessary and stir in sugar.
6. For cream of tomato soup stir in 50 ml (2floz) cream and reheat soup very gently without boiling. Garnish with a swirl of cream.

Menus

Fruity Chicken Casserole

4 chicken joints
1 red pepper, de-seeded and sliced
2 sticks of celery, chopped
1 large onion, peeled and sliced
100g (4 oz) mushrooms, sliced
400g (14 oz) can sliced peaches
3 tablespoons cornflour
1 tablespoon soya sauce
3 tablespoons malt vinegar
Salt and pepper

1. Skin chicken joints and place in 2 litre (3 1/2 pint) casserole dish.
2. Fry pepper, onion, celery and mushrooms in oil.
3. Cover chicken with vegetables.
4. Drain fruit, reserving juice, and add to casserole.
5. Blend cornflour with soya sauce, vinegar and reserved juice, bring to the boil in a saucepan, add seasoning and pour into casserole dish.

Rice Pudding

50g (2 oz) pudding rice
Knob of butter
25g (1 oz) sugar
500ml (1 pt) milk, warmed
Grated nutmeg

1. Place the washed rice into a greased dish and dot with butter.
2. Dissolve the sugar in the heated milk and pour over the rice.
3. Sprinkle grated nutmeg over the top.
4. Leave uncovered, place in oven.

Care and Cleaning

TURN OFF THE MAIN SWITCH BEFORE CLEANING.

Before switching on again, ensure that all controls are in the **OFF** position.

Cleaning the Exterior

The outside of both ovens can be cleaned, when cooled down, using a cloth which has been rinsed in warm soapy water. The oven can then be wiped down with a clean dry cloth.

Never use an abrasive powder as this will damage the surface.

Lower Oven

Remove the rod shelves and meat pan. Use a fine steel wool soap pad to remove stubborn stains from the rod shelves, meat pan and the floor of the oven. Refer to the instruction opposite for cleaning the 'Stay Clean' panels. **Do not use** aerosol cleaners on this oven as they could adversely affect the fan motor unit, and cannot be wiped off the fan blade.

Decorative Trims

It is advisable to clean the decorative trims regularly to prevent any build up of soiling which may detract from the appearance of the Cooker. The recommended method of cleaning is to wipe over the trims with a soft cloth wrung out in warm water, or mild non-abrasive cleaner. (If in doubt try the cleaner on a small area of trim which is not noticeable in normal use), then after wiping with a cloth wrung out in clear water, dry with a soft clean cloth.

Door & control panel trims

Regularly wipe with a clean damp cloth and polish with a clean dry cloth.

Do not use scouring pads or abrasive cleaners/powders which may scratch the surface. Under no circumstances should abrasive cleaning materials be used.

Top Oven

Use a fine steel wool soap pad to remove stubborn stains from the rod shelves, grill pan and floor and roof of the oven.

Stay Clean Oven Liners

Refer to the instructions below for cleaning the following Stay Clean panels; **Oven** – side and rear panels.

How Stay Clean Oven Liners Work

The surfaces of the Stay Clean oven liners are treated on the mottled face with a special vitreous enamel which absorbs cooking soils. At temperatures of 220°C (425°F) or above, the special surface enables these soils to be slowly destroyed. The higher the temperature, the more effective it is. In most cases normal cooking operations at this temperature will permit this cleaning operation to proceed during cooking.

However if higher cooking temperatures are not used regularly, it may be necessary, in order to prevent heavy soiling, to run the oven without meat pan, at maximum setting for a couple of hours in Fan Oven mode **ONLY**. This may be necessary once a month or every two or three months depending on the type and amount of oven cooking.

Care and Cleaning

It should not normally be necessary to clean the Stay Clean panels with water. If the user feels it is desirable to do so, wash them down in warm, soapy water, followed by rinsing with clear water: **Do not use biological/enzyme washing powder, harsh abrasives or oven chemical cleaners of any kind.** Replacement oven liners are available should you require them, from your nearest Hotpoint Service Centre (see back page).

Replacement of Oven Lamp

WARNING: ISOLATE THE COOKER FROM THE SUPPLY BEFORE REPLACING THE LAMP, TO AVOID ELECTRIC SHOCK.

Open the oven door and remove the rod shelves. Grip the light glass dome, unscrew anti-clockwise and lift out. Reach into the aperture with fingers, and unscrew the faulty lamp anti-clockwise (15W 300°C SES) which can be obtained from your nearest Hotpoint Service Centre. Fit replacement lamp, and refit dome. When screwing and unscrewing the faulty lamp use a thick cloth to protect your fingers should the lamp break.

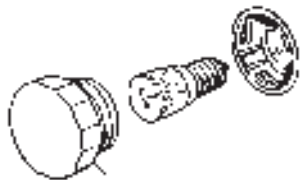

WARNING: ISOLATE COOKER FROM SUPPLY BEFORE REMOVING DOOR.

Oven Door Removal Main (Lower) Oven

The door is removable to facilitate occasional cleaning of heavy soiling from the oven floor and from the door itself.

Please note that the door is heavy and care should be taken not to pinch your fingers during the removal and replacement.

To remove, open the door fully and, using a coin or screwdriver, turn the two discs clockwise. Slightly close the door, unhook the lower hinge fingers, then pull the door away from the oven front frame.

To replace, insert the lower fingers and the hooked ends of the door stays, ensuring that the slots in the lower fingers engage with the front frame.

Fully open the door and turn the discs anti-clockwise to their normal working positions.

Close the door - the hinge will now lock into position.

Care and Cleaning

Take particular care not to damage the inner surface of the door inner glass that is coated with a heat reflective layer. Do not use scouring pads, or abrasive powder, which will scratch the glass. Ensure that the glass panel is not subjected to any sharp mechanical blows.

Stubborn stains can be removed by using a fine steel wool pad. For slight soiling the inner glass panel may be cleaned, while still warm, without removing it from the door. After cleaning, rinse and dry with a soft cloth.

CLEANING THE DOORS

SIDE OPENING DOORS

Cleaning the door glass is the same as the drop down doors, except take care to support the weight of the inner glass when removing and refitting.

DROP DOWN DOORS

Remove the door inner glass as follows.

1. Open the door fully and unscrew the two screws securing the glass panel so that the securing brackets can be turned. There is no need to remove the screws completely.
2. Turn the brackets so that the glass can be removed and cleaned at the sink (Fig. 1.)

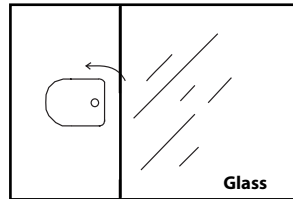

Fig. 1.

3. The inside of the outer door glass can now be cleaned while still fitted to the cooker.

NEVER OPERATE THE COOKER WITHOUT THE INNER DOOR GLASS IN POSITION.

Refit the door inner glass as follows.

1. **NOTE:** The inner door glass has a special reflective coating on one side. Replace the door inner glass so that the statement: "**IMPORTANT THIS FACE TOWARDS THE OVEN**" can be read from the inner side of the door.
2. Turn the two securing brackets back to their original position to retain the glass and tighten the screws. (Fig. 2.)

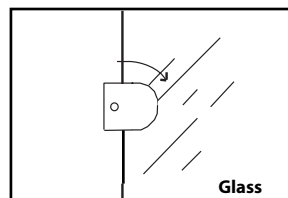

Fig. 2.

If something goes wrong...

**Before calling a Service Engineer, please check through the following lists.
THERE MAY BE NOTHING WRONG.**

- Slight odour or small amount of smoke when grill / oven used first time** This is normal and should cease after a short period.
- Nothing Works** If you find that the timer display is blank, then it is likely that there is no electricity supply to your oven. Check:
(i) That the main cooker wall is switched on
(ii) Other appliances, to see if you have had a power cut
(iii) The main circuit breaker for the property
- Timer Display shows "0:00" with "Auto" Flashing** The power supply to your oven has possibly been interrupted, but has now come back on again. Reset the timer to the correct day and "Manual" operation using the instructions given in the timer section of the book.
- Main oven and Top ovens do not work, but the grill works** Your timer may be set for an Auto Cooking programme: Check the timer to see whether "Auto" is lit or flashing. If it is then please follow the instructions given in the Timer section of this book to return the timer to Manual operation.
- Top oven and grill do not work, but Main oven works.** Operating the cooker under the following conditions may cause a safety device to operate:
(a) Grilling with the door closed - Always grill with the door fully open
(b) Grilling for an excessively long period at maximum setting - see Grilling guide.
Switch off appliance and allow to cool for approx 30 mins. Switch the cooker back on and check that the Grill / Top oven is now operating.
- Grill does not work** Ensure that the top oven control is set to the Full or Half grill position and set the grill control to the required setting.
- Grill keeps turning on and off** When the Grill control is operating at less than its maximum setting, the Grill will cycle on and off, this is normal and **not** a fault.
- Timer buzzer / bleeper operates continually** The bleeper will stop automatically after several minutes. To cancel, press the minute minder button to silence.
- Oven temperatures too high or low** Check temperature and shelf positions are as recommended in the Oven Temperature Charts. It may be necessary to increase or decrease the recommended temperature slightly to suit your taste.
- Oven does not cook evenly** Check:
(a) Temperature and shelf positions are as recommended in the Oven Temperature Charts.
(b) Oven utensils being used allow sufficient air flow around them.

If something goes wrong...

Grilling is uneven

Ensure that Grill pan has been positioned as stated in the Grilling section of this book.

Oven lamp does not work

The oven lamp is not covered by the guarantee. The part is easily changed (see the section on oven lamp replacement) A new lamp may be obtained from Genuine Parts & Accessories (see Back Page).

Condensation on the wall at the rear of the cooker.

Steam and / or condensation may appear from the vent at the rear of the appliance when using an oven particularly for foods with a high water content e.g. frozen chips, roast chicken etc. This is normal, and any excess should be wiped off.

Steam / Condensation in the oven after use.

Steam is a by - product of cooking any food with a high water contact. To help minimise always:

- a) Try to avoid leaving food in the oven to cool after being cooked.
- b) Use a covered container, wherever possible.

If you have been through the above list and there is still a problem, contact Service (see Back Page).

DISPOSAL OF YOUR PRODUCT

To minimise the risk of injury to children please dispose of your product carefully and safely. Remove all doors and lids (where fitted). Remove the mains cable (where fitted) by cutting off flush with the appliance and always ensure that no plug is left in a condition where it could be connected to the electricity supply.

To help the environment, Local Authority instructions should be followed for the disposal of your product.

Hotpoint Service Cover

Satisfaction Guaranteed or Your Money Back

Hotpoint gives you a unique 'Satisfaction Guaranteed' promise – valid for ninety days after you have purchased your Hotpoint product. If there is a technical problem with your Hotpoint appliance, just call Hotpoint Service (see back page). If necessary we will arrange for an engineer to call. If the technical problem is not resolved under this Guarantee, Hotpoint will replace your appliance or, if you prefer, give you your money back. Your statutory rights are not affected, and the Guarantee is additional and subject to the terms of Hotpoint's Five Year Parts Guarantee.

Hotpoint's Free Five Year Guarantee

From the moment your appliance is delivered Hotpoint guarantees it for **FIVE YEARS**.

- In the Five Years all replacement parts are **FREE** provided that they are fitted by our own Service Engineer. During the first year our Engineer's time and labour is also free.
- Our guarantee covers loss of food in our refrigeration and freezer products up to £250 during the first year, subject to verification by one of our engineers.
- After the first year we will charge for our Engineer's time and labour. We do, however, operate a range of Service Plans (see opposite) which, for an annual payment, enables you to cover any repair costs which may be necessary.
- All our service repairs are guaranteed for twelve months in respect of our labour and any parts fitted.
- The appliance must be used in the United Kingdom, and must not be tampered with or taken apart by anyone other than our own Service Engineers.
- You may, however, buy parts which can be safely fitted without specialist knowledge or equipment. The correct fitting of such parts, provided they are genuine Hotpoint spares, will not affect your Guarantee. Parts are available from our Hotpoint Spares Centres (see back page).
- Our guarantee does not cover the cost of any repair, or loss of food in refrigeration products, due to power failure, accidents or misuse. Nor does it cover the cost of any visits to advise you on the use of your appliance. Please read thoroughly the instruction book supplied with this appliance.
- If at any time during the Guarantee period we are unable to repair your appliance, we will refund any repair costs paid to us in the previous twelve months. We will also offer you a new appliance at a reduced charge instead of a repair.
- Our Guarantee is in addition to and does not affect your legal rights.
- Should you need independent advice on your consumer rights, help is available from your Consumer Advice Centre, Law Centre, Trading Standards Department and Citizens Advice Bureau.
- All Hotpoint servicing is carried out by our own Service Organisation located throughout the United Kingdom and Eire. We will be happy to deal with any problems which you may have.

Hotpoint's Extended Warranties

Whether you have just one or a number of Hotpoint appliances in your kitchen, Hotpoint has a range of Service Plans to give you complete peace of mind. They enable you to extend your one year labour guarantee so that you can have repairs completed FREE during the membership period.

Service Cover

We offer a number of payment methods; cheque, credit card or you can spread the cost and pay by direct debit (full details can be obtained on Free phone 0800 716356). This covers you for all repairs during the period of cover, which can be from 1 to 4 years. Service Cover also includes loss of food, up to the value of £250, in refrigeration appliances. There is also an option of Service Cover with Maintenance at an additional cost. This includes an annual Electrical and Safety check and replacement of any parts as necessary.

Kitchen Cover

An annual payment covers you for all repairs for all your Hotpoint appliances which are less than ten years old. It also covers the cost of loss of food up to £250 in our refrigeration and freezer products. There is also the option of Kitchen Cover with Maintenance at an additional cost. Any additional Hotpoint appliances purchased after you have joined Hotpoint Kitchen Cover will automatically be included during the annual period of cover without further charge.

Appliance Registration

To ensure that you have the opportunity to benefit from any of the above Service Schemes and other offers you should complete and return immediately the Appliance Registration Form/Questionnaire supplied with this appliance. Full details and costs of our Service Schemes, together with an application form, will be sent to you at the end of the first year of the guarantee.

Annual Safety/Maintenance Checks

Hotpoint strongly recommends that all its appliances are regularly checked for electrical and mechanical safety, whether or not they are covered by a Service Plan. Worn door gaskets or hoses may cause a leak on an appliance, which could become dangerous if neglected.

Proof of Purchase

For future reference please attach your purchase receipt to this booklet and keep it in a safe place.

Spares and Accessories

Spares and accessories can be ordered from your local Hotpoint Spares Centre (see back page), using the order form enclosed.

NOTE: Our Engineers will use every effort to avoid damage to floor coverings and adjacent units when carrying out repairs/service work, but in locations where the Engineer advises you that it will be impossible to move appliances without risk of damage, he will only proceed with your approval that no liability is accepted.

Key Contacts

Service

Hotpoint has the largest appliance manufacturer's service team in Europe, trained specialists directly employed by us to ensure your complete confidence.

Repair Service

UK: 08709 066 066

Republic of Ireland: 1850 302 200

You will be asked for the following information:-

Name, address and postcode.

Telephone number

Model / Serial number of the appliance

Clear and concise details of the query or fault

Place and Date of purchase

(Please keep the receipt as evidence will be required when the engineer calls).

Extended Warranty

To join: UK 08709 088 088

Republic of Ireland: 1850 502 200

Genuine Parts & Accessories Mail Order Hotline

UK: 08709 077 077

Republic of Ireland: (01) 842 6836

For further product information 08701 506070

All Hotpoint Services are offered as an extra benefit and do not affect your statutory rights.



General Domestic Appliances Limited, Morley Way, Peterborough, PE2 9JB

Free Manuals Download Website

<http://myh66.com>

<http://usermanuals.us>

<http://www.somanuals.com>

<http://www.4manuals.cc>

<http://www.manual-lib.com>

<http://www.404manual.com>

<http://www.luxmanual.com>

<http://aubethermostatmanual.com>

Golf course search by state

<http://golfingnear.com>

Email search by domain

<http://emailbydomain.com>

Auto manuals search

<http://auto.somanuals.com>

TV manuals search

<http://tv.somanuals.com>