

Use and Installation Instructions

CH60DTXF S CH60DPCF S CH60DPXF S CH60DTCF S

This appliance must be installed in accordance with the regulations in force and only used in a well ventilated space.

Read these instructions before installing or using the appliance and retain them for future reference.



Please phone us on
08448 24 24 24
to activate your
guarantee

PLEASE PHONE US TO REGISTER YOUR APPLIANCE AND ACTIVATE YOUR PARTS GUARANTEE ON 08448 24 24 24

CONTENTS

	PAGE
Warnings	3
Introduction	4
Safety Information	5
Installation	7
Features	14
The Controls	15
The Cooking Modes in your Cooker	18
Electronic Clock and Automatic Cooking Feature	20
Temperature Conversion Chart	23
Hotplate	24
Solar Plus Twin Grill	26
Top Oven - Conventional Cooking	28
Top Oven Cooking Temperature Charts	29
Main Oven - The Precision Cooking System	31
Main Oven Cooking Temperature Charts	32
Care and Cleaning	35
Something wrong with your Cooker	38
Disposal of the appliance	39
Guarantee Information	40
Service Information	41

Retention of this Instruction Book

This Instruction Book must be kept handy for reference as it contains important details on the safe and proper use of the appliance.

If you sell or pass the appliance to someone else, or move house and leave it behind, make sure this Book is also provided so the new owner can become familiar with the appliance and safety warnings.

PLEASE PHONE US TO REGISTER YOUR APPLIANCE AND ACTIVATE YOUR PARTS GUARANTEE ON 08448 24 24 24

WARNINGS

WARNING: The appliance and its accessible parts become hot during use. Care should be taken to avoid touching heating elements. Children less than 8 years of age shall be kept away unless continuously supervised.

This appliance can be used by children aged from 8 years and above and persons with reduced physical, sensory or mental capabilities or lack of experience and knowledge if they have been given supervision or instruction concerning use of the appliance in a safe way and understand the hazards involved. Children shall not play with the appliance. Cleaning and user maintenance shall not be made by children without supervision.

WARNING: Unattended cooking on a hob with fat or oil can be dangerous and may result in fire.

NEVER try to extinguish a fire with water, but switch off the appliance and then cover flame e.g. with a lid or a fire blanket. Do not use harsh abrasive cleaners or sharp metal scrapers to clean the oven door glass since they can scratch the surface, which may result in shattering of the glass.

The internal surfaces of the compartment (where present) may become hot. Never use steam cleaners or pressure cleaners on the appliance. Remove any liquid from the lid before opening it.

Do not close the glass cover (if present) when the gas burners or electric hotplates are still hot.

WARNING: Ensure that the appliance is switched off before replacing the lamp to avoid the possibility of electric shock.

CAUTION: the use of inappropriate hob guards can cause accidents.

! When you place the rack inside, make sure that the stop is directed upwards and in the back of the cavity .

INTRODUCTION

To help you make the best use of your cooker, PLEASE READ THIS BOOKLET CAREFULLY.

Your new cooker is guaranteed and will give lasting service. The guarantee is only applicable if the cooker has been installed in accordance with the Installation Instructions.

The cooker is designed specifically for domestic use and responsibility will not be accepted for use in any other installation.

When first using the cooker ensure that the room is well ventilated (e.g. open a window or use an extractor fan) and that persons who may be sensitive to the odour avoid any fumes. It is suggested that any pets be removed from the room until the smell has ceased. This odour is due to any temporary finish and also any moisture absorbed by the insulation.

Our policy is one of continual improvement in design and development, therefore strict accuracy of illustrations and descriptions cannot be guaranteed.



This appliance conforms with the following European Economic Community directives:

- 2006/95/EC of 12/12/06 (Low Voltage) and subsequent modifications;
- 2004/108/EC of 15/12/04 (Electromagnetic Compatibility) and subsequent modifications;
- 90/396/EEC of 29/06/90 (Gas) and subsequent modifications (only for models which use gas);
- 93/68/EEC of 22/07/93 and subsequent modifications.
- 2002/96/EC
- 1275/2008 (Stand-by/Off mode)

Technical Characteristics

Top Oven	Usable Volume: 39 Litres
----------	--------------------------

ENERGY LABEL - Top Oven

Directive 2002/40/EC on the label of electric ovens

Norm EN 50304

Declared energy consumption for

Natural convection Class

heating mode: Conventional

Main Oven

Usable Volume: 67 Litres

ENERGY LABEL - Main Oven

Directive 2002/40/EC on the label of electric ovens

Norm EN 50304

Declared energy consumption for

Natural convection Class

heating mode: Fan Oven

Voltage and Frequency

230-240V~ 50Hz

PLEASE PHONE US TO REGISTER YOUR APPLIANCE AND ACTIVATE YOUR PARTS GUARANTEE ON 08448 24 24 24

FOR YOUR SAFETY

Please read the precautions below before using your cooker.

ALWAYS . . .

- ALWAYS make sure you understand the controls before using the cooker.
- ALWAYS check that all controls on the cooker are turned off after use.
- ALWAYS stand back when opening an oven door to allow heat to disperse.
- ALWAYS use dry, good quality oven gloves when removing items from the ovens.
- ALWAYS take care when removing items from the top oven/grill when the main oven is on, as the contents may be hot.
- ALWAYS keep the oven and grill doors closed when the cooker is not in use.
- ALWAYS place pans centrally over the hotplate burners and position them so that the handles cannot accidentally be caught or knocked or become heated by other burners.
- ALWAYS keep the cooker clean, as a build up of grease or fat from cooking can cause a fire.
- ALWAYS allow the cooker to cool before cleaning.
- ALWAYS follow the basic principles of food handling and hygiene to prevent the possibility of bacterial growth.
- ALWAYS keep ventilation slots clear of obstructions.
- ALWAYS turn off the electricity supply before cleaning or replacing an oven lamp.
- ALWAYS refer servicing to Gas Safe registered appliance service engineers.

- The appliance should not be operated by people (including children) with reduced physical, sensory or mental capacities, by inexperienced individuals or by anyone who is not familiar with the product. These individuals should, at the very least, be supervised by someone who assumes responsibility for their safety or receive preliminary instructions relating to the operation of the appliance.
- The appliance must be used by adults only for the preparation of food, in accordance with the instructions outlined in this booklet. Any other use of the appliance (e.g. for heating the room) constitutes improper use and is dangerous. The manufacturer may not be held liable for any damage resulting from improper, incorrect and unreasonable use of the appliance.
- This product complies with the requirements of the latest European Directive on the limitation of power consumption of the standby mode.
If no operations are carried out for a period of 2 minutes, the appliance automatically switches to the standby mode.
The standby mode is visualised by the high luminosity "Watch Icon".
As soon as interaction with the machine resumes, the system's operating mode is restored.

FOR YOUR SAFETY

NEVER . . .

- NEVER leave children unsupervised where the cooker is installed as all surfaces will get hot during and after use.
- NEVER allow anyone to sit or stand on any part of the cooker.
- NEVER store items that children may attempt to reach above the cooker.
- NEVER heat up unopened food containers as pressure can build up causing the container to burst.
- NEVER store chemicals, food stuffs, pressurised containers in or on the cooker, or in cabinets immediately above or next to the cooker.
- NEVER fill a deep fat frying pan more than 1/3 full of oil, and never use a lid. **DO NOT LEAVE UNATTENDED WHILE COOKING.**
- NEVER place flammable or plastic items on or near the hotplate.
- NEVER use proprietary spillage collectors on the hotplate.
- NEVER use the cooker as a room heater.
- NEVER dry clothes or place other items over or near to the hotplate or oven/grill doors.
- NEVER wear garments with long flowing sleeves whilst cooking.

NOTE: The use of a gas cooking appliance results in the production of heat and moisture in the room in which it is installed. Always ensure that the kitchen is well ventilated; keep natural ventilation holes open or install a mechanical ventilation device (mechanical extractor hood).

In particular when using the grill or more than one hotplate burner, open a window if a mechanical ventilation device is not operating.

! The appliance should not be operated by people (including children) with reduced physical, sensory or mental capacities, by inexperienced individuals or by anyone who is not familiar with the product. These individuals should, at the very least, be supervised by someone who assumes responsibility for their safety or receive preliminary instructions relating to the operation of the appliance.

PLEASE PHONE US TO REGISTER YOUR APPLIANCE AND ACTIVATE YOUR PARTS GUARANTEE ON 08448 24 24 24

INSTALLATION INSTRUCTIONS

Prior to installation, ensure that the local distribution conditions (nature of the gas and gas pressure) and the adjustment conditions are compatible. The adjustment conditions for this appliance are stated on the data badge which is fitted on the back panel.

This appliance is not designed to be connected to a combustion products evacuation device. It must be installed and connected in accordance with current installation regulations. Particular attention should be given to the relevant requirements regarding ventilation.

MODEL NUMBERS:

CH60DTXF S CH60DPCF S CH60DPXF S CH60DTCF S

Category II2H3+ (GB)

These models are set to burn NATURAL GAS (G20) at 20 mbar but can be converted for use on BUTANE (G30) at 28-30mbar or PROPANE (G31) at 37mbar with the use of the LPG conversion kit that can be obtained free of charge, if you contact our Genuine Parts and Accessories department (see Key Contacts, back page).

GAS SAFETY (INSTALLATION & USE) REGULATIONS

It is the law that all gas appliances are installed by competent persons in accordance with the current edition of the above regulations. It is in your interest and that of safety to ensure compliance with the law. In the UK, Gas Safe registered installers work to safe standards of practice. The cooker must also be installed in accordance with BS 6172. Failure to install the cooker correctly could invalidate the warranty liability claims and could lead to prosecution.

LOCATION

The cooker may be located in a kitchen, kitchen/diner or a bed-sitting room, but not in a room containing a bath or shower. The cooker must not be installed in a bed-sitting room of less than 20m³.

When adjusted for use on Butane (G30) or Propane (G31), the cooker must not be installed in a room or internal space below ground level, e.g. in a basement.

PROVISION FOR VENTILATION

The room containing the cooker should have an air supply in accordance with BS 5440: Part 2.

The room must have an opening window or equivalent; some rooms may also require a permanent vent. If the room has a volume between 5 and 10m³, it will require an air vent of 50cm² effective area unless it has a door which opens directly to outside. If the room has a volume of less than 5m³, it will require an air vent of 100cm² effective area. If there are other fuel burning appliances in the same room, BS 5440: Part 2 should be consulted to determine air vent requirements.

Safety Chain

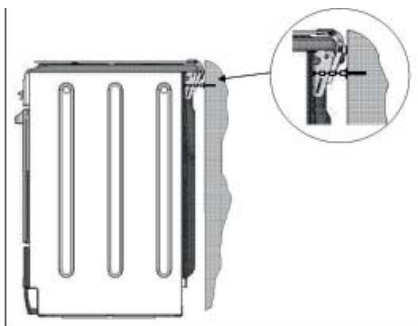

! In order to prevent accidental tipping of the appliance, for example by a child climbing onto the oven door, the supplied safety chain **MUST** be installed!

Choose the screw and the screw anchor according to the type of material of the wall behind the appliance. If the head of the screw has a diameter smaller than 9mm, a washer should be used. Concrete wall requires the screw of at least 8mm of diameter, and 60mm of length.

Ensure that the chain is fixed to the rear wall of the cooker and to the wall, as shown in figure, so that after installation it is tensioned and parallel to the ground level.

The cooker is fitted with a safety chain to be fixed by means of a screw (not supplied with the cooker) to the wall behind the appliance, at the same height as the chain is attached to the appliance.

INSTALLATION INSTRUCTIONS

TECHNICAL DATA

Gas connection	Rp 1/2 (1/2" BSP female)
Pressure test point	Front left hotplate injector
Gas rate adjustment	None
Aeration adjustment	None
Electrical connection	4mm ² twin and earth 230/240V a.c. 50Hz.

Professional 60 CH60DPCF S CH60DPXF S	G20 at 20mbar		G30 at 28-30mbar G31 at 37mbar	
	HEAT INPUT	INJECTOR	HEAT INPUT	INJECTOR
HOTPLATE Front Left	4.1 kW	100+72+100	3.8 kW (275g/h)	63+42+63
HOTPLATE Rear Right	3.05 kW	116	3.0 kW (220g/h)	86
HOTPLATE Front Right and Rear Left	2.0 kW	103	2.0 kW (145g/h)	70
TOTAL LOAD	4.5 / 4.9 kW			

Traditional 60 CH60DTXF S S CH60DTCF S	G20 at 20mbar		G30 at 28-30mbar G31 at 37mbar	
	HEAT INPUT	INJECTOR	HEAT INPUT	INJECTOR
HOTPLATE Front Left and Rear Right	3.05 kW	116	3.0 kW (220g/h)	86
HOTPLATE Front Right and Rear Left	2.0 kW	103	2.0 kW (145g/h)	70
TOTAL LOAD	4.5 / 4.9 kW			

PLEASE PHONE US TO REGISTER YOUR APPLIANCE AND ACTIVATE YOUR PARTS GUARANTEE ON 08448 24 24 24

INSTALLATION INSTRUCTIONS

SPACE FOR FIXING

The cooker can be close fitted below hotplate level. This requires a minimum distance of 600mm between cupboard units of hotplate height.

When installing next to a tall cupboard, partition or wall, for a minimum distance of 400mm above hotplate level, allow a side clearance of at least 65mm.

The diagram below illustrates the minimum clearance between the cooker and adjacent walls, cupboards etc.

The wall behind the cooker, 50mm below and 450mm above, and the width of the cooker, must be a non-combustible material such as ceramic wall tiles.

If the cooker is to be fitted close to a corner on the left hand side, ensure that there is a clearance of at least 50mm to allow the main oven door to open fully for when removing oven shelves.

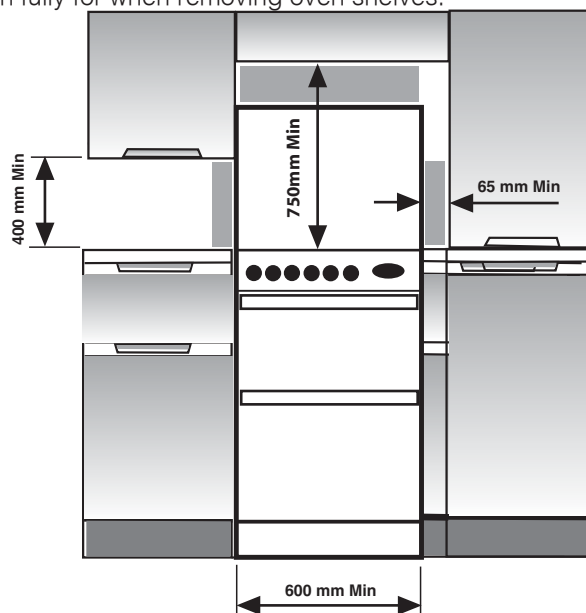

COOKER HOODS

If a cooker hood is to be installed, refer to the cooker hood manufacturers' instructions regarding fixing height.

INSTALLATION INSTRUCTIONS

SPACE FOR FIXING

The cooker can be close fitted below hotplate level. This requires a minimum distance of 600mm between cupboard units of hotplate height.

When installing next to a tall cupboard, partition or wall, for a minimum distance of 400mm above hotplate level, allow a side clearance of at least 65mm.

The diagram below illustrates the minimum clearance between the cooker and adjacent walls, cupboards etc.

The wall behind the cooker, 50mm below and 450mm above, and the width of the cooker, must be a non-combustible material such as ceramic wall tiles.

If the cooker is to be fitted close to a corner on the left hand side, ensure that there is a clearance of at least 50mm to allow the main oven door to open fully for when removing oven shelves.

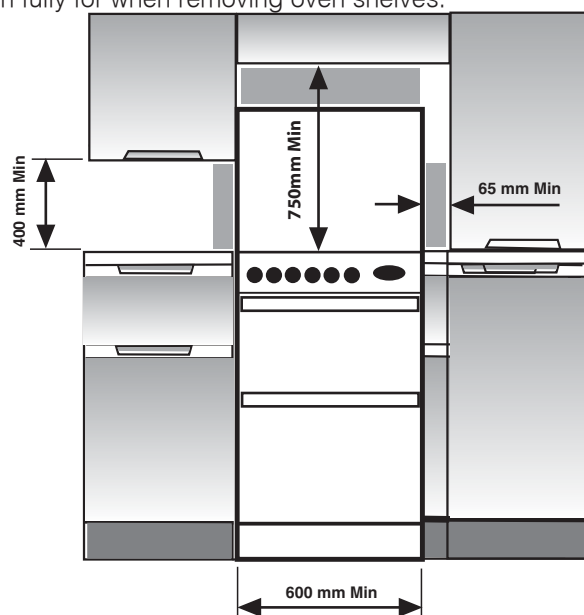

COOKER HOODS

If a cooker hood is to be installed, refer to the cooker hood manufacturers' instructions regarding fixing height.

INSTALLATION INSTRUCTIONS

UNPACKING THE COOKER

Unpack the components from inside the grill and oven. Check that the following parts are present:

Grill pan and grid	Aluminium burner bodies (4)
Baking dish	Pan supports
Main oven shelves (2)	Enamelled burner caps (4)
Top oven/grill shelf (1)	Literature

LEVELLING

Four skid feet are fitted which can be adjusted up or down to level the cooker.

CONVERSION FOR USE ON BUTANE (G30) OR PROPANE (G31)

Each burner requires the injector to be replaced and bypass screws adjusted or replaced as follows:

1. Remove the loose hotplate burner parts.
2. Using a 7mm socket, replace the hotplate injectors as appropriate (see table on previous page).
3. Re-position the loose burner parts.
4. Carefully pull off the hotplate control knobs.
5. Using a narrow flat bladed screwdriver rotate the bypass screws fully clockwise. The hotplate tap bypass screws are located down the centre of the spindle.
6. Re-assemble the control panel parts.
7. Secure the self-adhesive LPG conversion label over the gas details on the data badge.

Connection of the hose

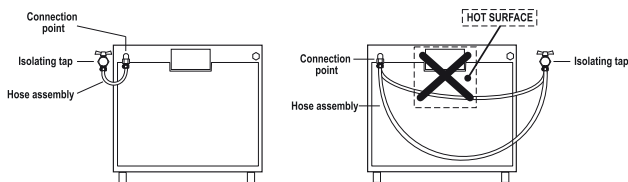

INSTALLATION INSTRUCTIONS

STABILITY CHAIN

A hole in the gas inlet valve bracket can be used to engage a stability chain.

CONNECTING TO GAS SUPPLY

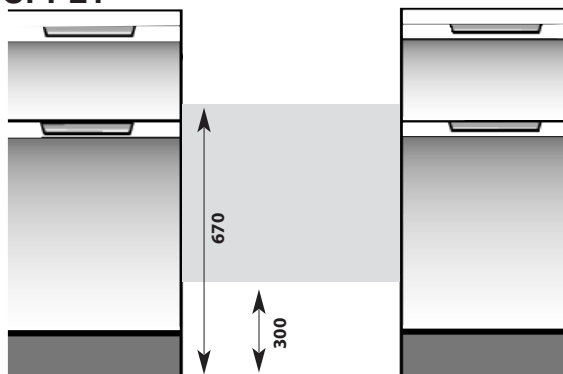

Connection to the cooker should be made with an approved appliance flexible connection to BS 669. A length of 0.9 to 1.25m is recommended. The length of hose chosen should be such that when the cooker is in situ, the hose does not touch the floor.

Those cookers converted to use on LPG should be connected with a hose suitable for LPG and capable of withstanding a pressure of 50 mbar.

An adaptor backplate should be fitted within the shaded area shown, to allow the cooker to be pushed fully to the wall and to ensure that the flexible hose is only likely to come into contact with areas at the rear of the cooker that do not exceed a temperature rise of 70°C.

ELECTRICAL CONNECTION

WARNING - THIS APPLIANCE MUST BE EARTHED.

The cooker must be connected by a qualified electrician to a suitable double - pole control unit with a minimum rating of 32A and a minimum contact clearance of 3mm, which should be fitted adjacent to (but not above) the cooker, in accordance with IEE regulations.

The power supply cable should conform to BS6004 with a conductor size of 4mm².

The control unit should be easily accessible in the event of an emergency.

This appliance conforms to EN55014 regarding suppression of radio and television interference.

The cooker terminals are behind the cover at the rear. The mains cable must pass through the cable clamp and the screws must be fully tightened. Sufficient cable should be used to allow the cooker to be pulled out for servicing. Ensure that the cover is fully closed and secure afterwards.

Take care not to trap the mains cable when pushing the cooker into its final position.

INSTALLATION INSTRUCTIONS

OPERATIONAL CHECKS

After installation, check for gas soundness. The supply pressure can be checked at one of the hotplate burner injectors.

Check that the hotplate burners ignite correctly and burn with a steady flame. Check for a steady flame at the low setting.

Instruct the user on the operation of the cooker.

FEATURES

WARNING: DO NOT touch the oven doors when the oven is in use as these areas can become hot.

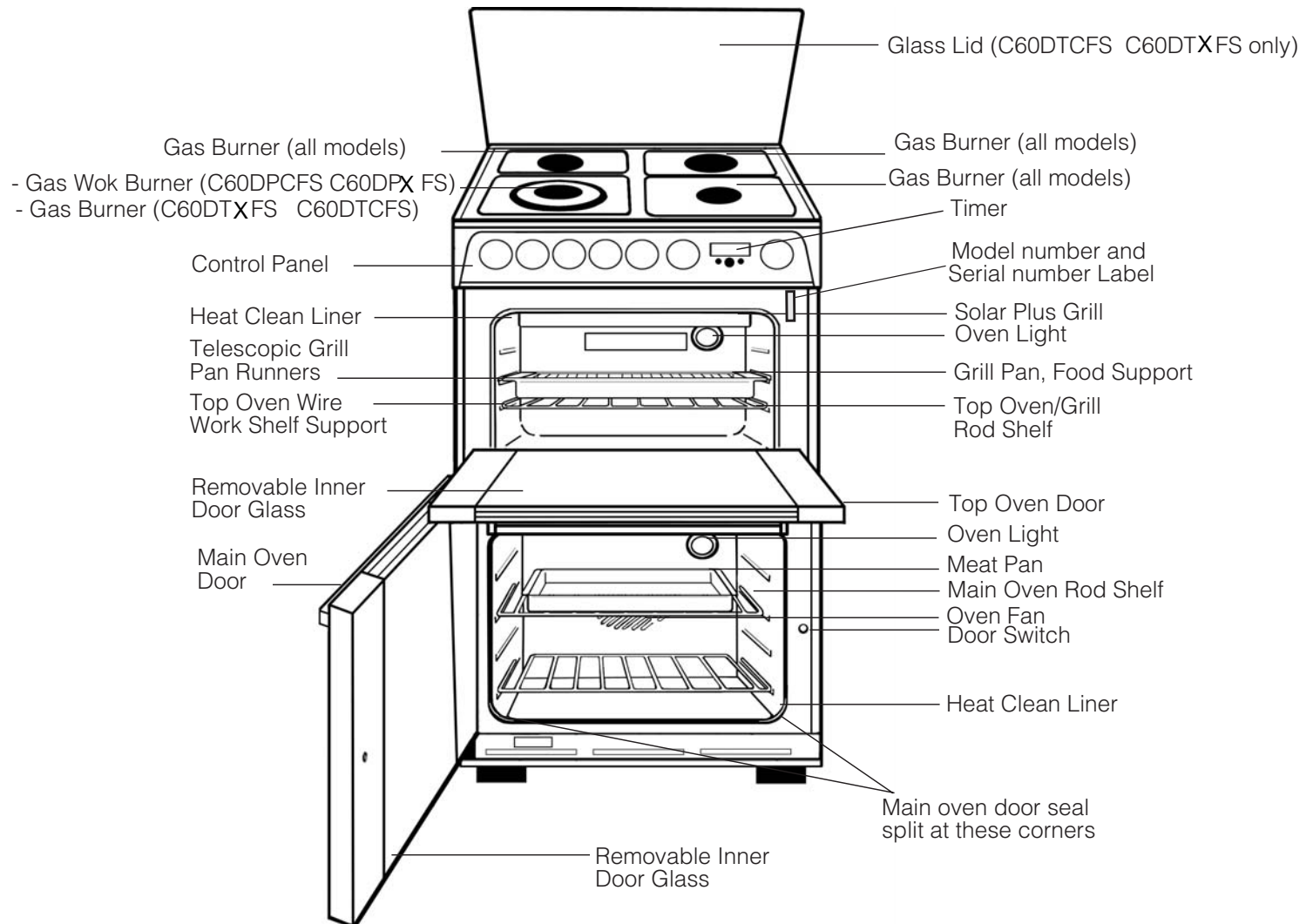

NOTE: To keep the controls cool when the appliance is used, a gentle flow of air may be blown from beneath the control panel. If the appliance is still warm, this cooling fan may run on or restart itself when all controls have been turned off.

This is normal and is not a fault.

The fan will stop once the appliance has cooled.

NOTE: Children should not be allowed to play with the appliance or tamper with the controls.

PLEASE PHONE US TO REGISTER YOUR APPLIANCE AND ACTIVATE YOUR PARTS GUARANTEE ON 08448 24 24 24

THE CONTROLS

Switch on the electricity supply to the cooker at the Cooker Control Unit.

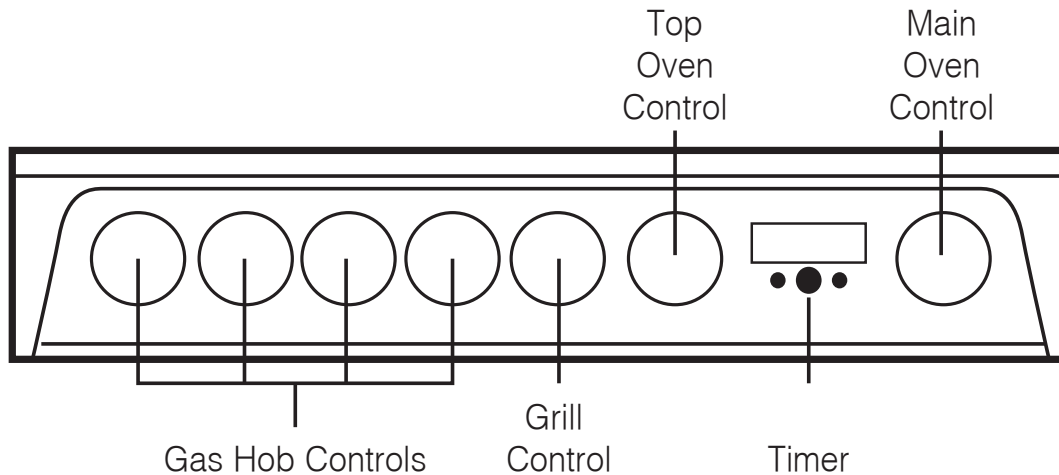

Gas Hob Controls

Push in and turn the control knob anti-clockwise to the large flame symbol. Continue to push in the control until the sparks light the gas.

Turn the control knob anti-clockwise to reduce the heat input.

Only turn the control between the large flame symbol and the small flame symbol when adjusting the setting.

To turn off, turn the control knob fully clockwise to the symbol 'O', its off position.

Main Oven Light

The main oven light can be switched on, when the oven is not in use, by pressing the oven light button on the display. The oven light will also operate whenever the main oven door is opened.

NOTE: The oven light can be switched off when the door is opened by pressing the oven light button on the display, or by closing the door.

Cooling Fan

The cooling fan operates with the ovens and grill. The fan will operate at full speed for a few seconds and then reduce to a lower speed. The cooling fan will only increase to full speed if the temperature inside the cooker reaches above a certain limit.

THE CONTROLS

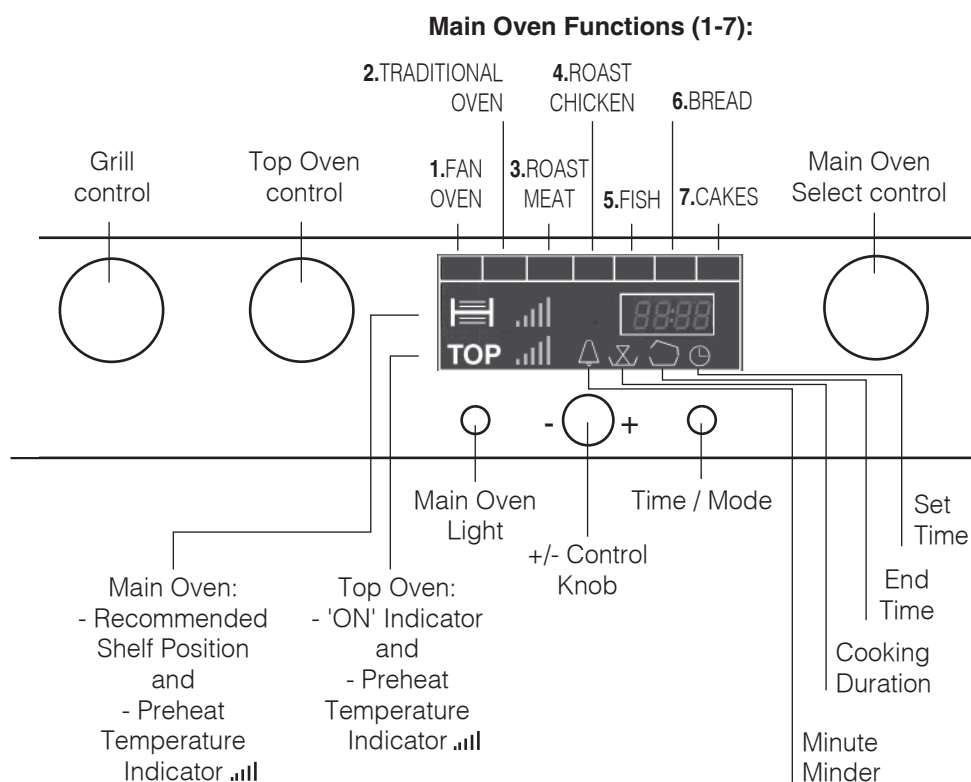

Grill Control - Top Oven

The grill control will not operate unless the top oven control is in the 'O' off position. The grill control provides fully variable heat control for either the twin grill or single (left hand side) grill by selecting any number between 1 & 4. When turned clockwise the twin grill will be switched on and any power setting from 1 - 4 can be selected. The power level numbers are indicated on the control knob. When turned anti-clockwise the single grill will be switched on and any power setting from 1 - 4 can be selected. The power level numbers are indicated on the control knob. The off position is identified by an 'O'.

Top Oven Control

This control switches on the top and bottom heating elements in the top oven. The temperature in the oven can be set anywhere between 100°C and 220°C. The top oven ON indicator (TOP) and the top oven preheat temperature indicator (four vertical bars symbol) will be on the display (bottom left hand corner). The top oven preheat temperature indicator (four vertical bars symbol) will switch OFF and an audible tone will sound when the top oven has reached the required temperature. When in operation the oven light will be illuminated. The off position is identified by an 'O'.

Notes

If both the top oven and grill controls are turned on together, the (TOP) and (four vertical bars symbol) will flash on the display. The cooker will continue to operate in the function which was selected first.

THE CONTROLS

Main Oven Control

This control switches on the top and rear heating elements at various times in the main oven, dependent on which mode has been set.

The temperature of the main oven can be set anywhere between 80°C and 230°C in cooking modes 1 - 5.

The main oven preheat temperature indicator (⏱️ symbol) will be on the display (middle, left hand side).

The main oven preheat temperature indicator (⏱️ symbol) will switch OFF and an audible tone will sound when the main oven has reached the required temperature.

The Main Oven Cooking Functions

The main oven has eight cooking functions. Use the main oven control to select the cooking mode you require. The display will show the function you have selected, across the top (1 - 7) with the eighth function being shown on the clock display as '(RISE)'.

Adjusting the Main Oven Temperature

When a program is set (position 1 - 5), the display will automatically suggest a cooking temperature. If you wish you can use the +/- control knob to change the suggested temperature to one of your own choice, within a range which is suitable for the particular cooking mode.

THE COOKING MODES IN YOUR COOKER

Your new cooker is equipped with a number of different cooking modes:



Conventional Heating (Top Oven)

- with upper and lower heat. This system is particularly suitable for roasting and baking on one shelf only.



Variable Grilling (Top Oven)

- the oven can also be used for conventional grilling with a full or half width fully controllable grill.

Note: The Top Oven door should be open when grilling.



Fan Oven (Main Oven)

- the fan oven operates by constantly blowing heated air, from an element wrapped around the fan, into the oven. This gives improved efficiency and in general, enables the use of lower temperatures for cooking. It also means that there is less need to be particular about shelf positions and that you can bake at more than one level simultaneously (Batch Baking).



Traditional (Main Oven)

- the upper and rear heating elements are switched on in this position. The traditional oven brings an outstanding level of temperature distribution and reduced consumption. In traditional cooking use only one rack to ensure good heat distribution. By using the various shelf positions available you can balance the quantity of heat between the upper and lower part. If cooking requires more heat from below or above, use the lower or higher shelves respectively.



Roast Meat (Main Oven)

- specially created for cooking joints of meat. This mode raises the temperature in the oven to a very high heat for the first part of the cooking cycle, to seal the outside of the joint and retain the juices of the meat throughout cooking. After this the temperature is reduced to the set temperature using each heating element in turn to guarantee a homogeneous temperature for the cooking period. A temperature is suggested on this mode but this can be altered using the '+/-' control knob.



Roast Chicken (Main Oven)

- specially created for cooking excellent roast poultry. This mode can be used to roast chickens, duck, turkey and other poultry to perfection. Each heating element is used in the cycle to guarantee a homogeneous temperature within the oven. A temperature is suggested on this mode but this can be altered using the '+/-' control knob.

PLEASE PHONE US TO REGISTER YOUR APPLIANCE AND ACTIVATE YOUR PARTS GUARANTEE ON 08448 24 24 24

THE COOKING MODES Hotpoint IN YOUR COOKER



Fish (Main Oven)

- this mode provides gently pulsing top and rear heat to lightly poach fish dishes without overcooking or drying out. A temperature is suggested on this mode but this can be altered using the ,+/-' control knob.



Rising (Main Oven)

- this mode heats and holds the oven at 40°C. It is ideal for proving bread and yeast based dough mixtures. When this mode is selected a cooking duration of 14 minutes is automatically set, this can be altered by pressing the ,time/mode' button until the cooking duration icon flashes. Then use the ,+/-' control knob to adjust the cooking duration.



Bread cycle - Auto

- this mode is fully automatic and lasts for 1 hour. When this mode is selected the time and temperature cannot be adjusted. It is suitable for baking bread weighing up to 1.5kg, either in a tin or on a baking tray. This mode includes a proving cycle and a baking cycle. If an initial proving cycle is needed this can be done using the RISE mode (8).



Cake cycle - Auto

- this mode is fully automatic and lasts for 1 hour. When this mode is selected the time and temperature cannot be adjusted. It is suitable for baking sponge based cakes that take between 30 minutes and 1 hour to cook.

! After selecting any of the oven programs, the parameter setting of the product is activated. It optimizes the performance of cooking, but could result in a delayed ignition of fan and heating elements.

WARNING! The oven is provided with a stop system to extract the racks and prevent them from coming out of the oven.(1)

As shown in the drawing, to extract them completely, simply lift the racks, holding them on the front part, and pull (2).

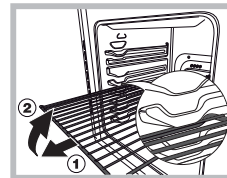

ELECTRONIC CLOCK & AUTOMATIC COOKING FEATURE

When you first switch on the appliance you will be prompted to set the 'Time of Day' on the display. You must ensure you have done this before attempting to use the automatic cooking feature.

AUTOMATIC COOKING

The main oven can be controlled automatically.

HINTS ON AUTOMATIC COOKING

- Select food which will require the same cooking time and temperature.
- To ensure food does not cool down and require reheating, set the end time so the food is ready when you require it.
- Always ensure that meat and poultry is defrosted before placing in the oven.
- Whenever possible, take food out of the refrigerator and keep it as cool as possible.
- If cooking food that requires frying before placing in the oven for automatic cooking, keep the delay time to a minimum.
- Never place hot or warm food in the oven for delayed start cooking as it could cause the oven to be warm and produce harmful bacteria in the food.
- We advise that dishes containing left-over cooked poultry and meat, eg. shepherds pie, should not be cooked automatically if there is to be a delay period.
- Ensure that delay start times are kept to a minimum to prevent bacterial growth in food.
- Wine or beer may ferment and cream may curdle during the delay period, so it is best to add these ingredients just before serving.
- Foods which discolour should be protected by coating in fat or tossing in water to which lemon juice has been added, prior to placing food in the oven.
- Dishes containing liquid should not be filled too full to prevent boiling over.
- Food should be well sealed (but not airtight) in a container to prevent the loss of liquid during cooking. Aluminium foil gives a good seal.
- Always ensure that food is piping hot and cooked thoroughly before serving.
- Only reheat food once.

SETTING THE TIME OF DAY:

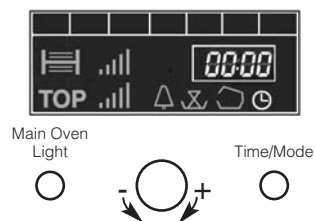

STEP 1. Check the electricity supply to the cooker is turned on.

STEP 2. When switched on the display will show both 00:00 and the 'set time' symbol flashing. Wait until these stop flashing.

STEP 3. Press the Time/Mode button once, so that the 'Set Time' symbol and the display are flashing. Turn the +/- control knob until the correct hour is set.

STEP 4. Press the Time/Mode button once, so that the 'Set Time' symbol and the display are flashing. Turn the +/- control knob until the correct minutes are set. Press the Time/Mode button again.

TIME OF DAY IS NOW SET.

To alter the time of day after the first setting, simply press the Time/Mode button. The 'Set Time' symbol and the display will flash. Repeat STEPS 3 and 4.

PLEASE PHONE US TO REGISTER YOUR APPLIANCE AND ACTIVATE YOUR PARTS GUARANTEE ON 08448 24 24 24

ELECTRONIC CLOCK & Hotpoint AUTOMATIC

COOKING FEATURE

SETTING THE MINUTE MINDER:

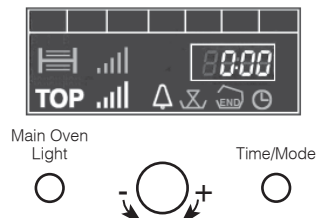

STEP 1. Press the Time/Mode button, until the 'bell' symbol is flashing.

STEP 2. Turn the +/- control knob to set the duration in minute increments until the required time is set. After a few seconds the 'bell' symbol will stop flashing and the time will count down.

THE MINUTE MINDER IS NOW SET.

At the end of the set time an audible tone will be heard and the 'bell' symbol will go out. After a few seconds the audible tone will stop and after a few seconds the display will revert back to the time of day.

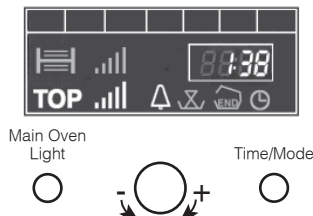

The minute minder can be cancelled at any time by following STEPS 1 and 2, setting the time period to zero using the +/- control knob. The display will revert back to the time of day.

The display shows HOURS and MINUTES eg. 1 hour 38 minutes

AUTO COOKING TIMER

There are two Auto Cooking programmes for the main oven, that can be selected using the display:

- (a) To set the main oven to switch ON immediately and OFF automatically after a time of your choice.
- (b) To set the main oven to switch ON and OFF automatically, at the times of your choice.

(a) To set the main oven to switch ON immediately and OFF automatically:

This allows you to cook for a specified duration, after which the oven will automatically switch off.

To adjust the duration of the cooking cycle press the Set timer button once. Adjust the present time by rotating the Set Temperature/Time knob to the required time. Once the desired duration of time is displayed press the Set Time button once to activate the programme.

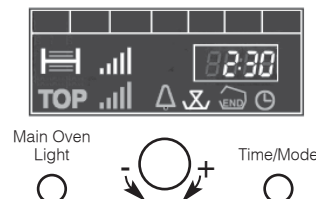

STEP 1. Check that the correct time of day is set, if not follow instructions for setting the time of day.

STEP 2. Place food to be cooked on shelf in the oven.

STEP 3. Switch the main oven control to the desired mode. The display will automatically suggest a cooking temperature. This can be changed by turning the +/- control knob. (The oven will start).

STEP 4. Press the Time/Mode button, until the 'cooking duration' symbol is flashing.

STEP 5. Turn the +/- control knob to set the cooking duration you require. After a few seconds the 'cooking duration' symbol will stop flashing and the display will show the temperature that has been set. This will change every few seconds when the display will show the cooking duration remaining.

THE COOKING DURATION IS NOW SET.

PLEASE PHONE US TO REGISTER YOUR APPLIANCE AND ACTIVATE YOUR PARTS GUARANTEE ON 08448 24 24 24

ELECTRONIC CLOCK & AUTOMATIC COOKING FEATURE

At the end of the set cooking duration, 'End' will show in the display and an audible tone will be heard for a few seconds.

Turn the main oven control to 'O', the OFF position to switch the oven off. The display will revert back to the time of day.

To cancel the automatic mode at any time turn the main oven control to 'O', the OFF position.

Note: During the cooking period the cooking duration will be shown in the display for a few seconds and then revert to the temperature set.

(b) To set the main oven to switch ON and OFF immediately:

This allows you to cook for a specified duration and additionally choose the time you wish the cooking cycle to finish. From this information the system works out when the cooking cycle will need to start and automatically switches the oven on at the required time.

- Follow STEPS 1 to 5 in the previous section (a) entitled: 'To set the main oven to switch ON immediately and OFF automatically', then continue as below:

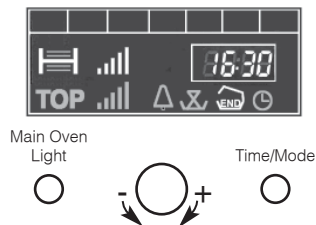

STEP 6. Press the Time/Mode button, until the 'end time' symbol is flashing. The display will show a default cooking end time (this will be the current time plus the cooking duration you set in STEP 5). The 'end time' symbol will flash.

STEP 7. Turn the +/- control knob to set the time you wish the cooking to end. After a few seconds the display the temperature, cooking duration and end time in turn.

THE COOKING DURATION AND END TIME IS NOW SET.

The display will show the temperature and cooking duration when the programme has started.

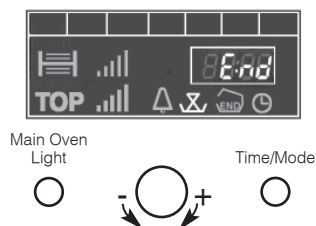

At the end of the cooking duration, 'End' and the 'cooking duration' symbol will show in the display and an audible tone will be heard for a few seconds.

Turn the main oven control to 'O', the OFF position to switch the oven off. The display will revert back to the time of day.

To cancel the automatic mode at any time turn the main oven control to 'O', the OFF position.

Note: At any time up to the start of cooking, the cooking end time, cooking duration and the temperature will be shown in the display.

TEMPERATURE Hotpoint CONVERSION CHART

Gas Mark	°F	Main Conventional Oven	Top Conventional Oven	Main Fan Oven
½	250	120	110	100
1	275	140	130	120
2	300	150	140	130
3	325	160	150	140
4	350	180	170	160
5	375	190	180	170
6	400	200	190	180
7	425	220	210	200
8	450	-	220	210
9	475	-	-	220

Temperatures

The recommended temperatures given are for conventional and fan ovens. When using a fan oven it will be necessary to reduce the cooking time by 10 minutes per hour and lower the temperature by up to 20°C. Also, in the majority of cases, it is not necessary to pre-heat the oven. However, pre-heating is recommended when cooking items such as Yorkshire puddings, whisked sponges and bread. Your experience with the cooker will enable you to select the cooking time and temperature best suited for your recipe.

Condensation

Condensation may become evident on the inner door and water may drip through the vent. This is normal when heat and moisture are present and may be a result of any of the following:

1. Kitchen temperature and ventilation.
2. The moisture content of the food eg. meat, roast potatoes, Yorkshire pudding, roasting meat, etc.
3. The quantity of the food being cooked at any one time.

HOTPLATE

The hotplate lid is fitted with a safety device which cuts off the gas supply to the hotplate burners unless the lid is fully open. Do not use the safety device as a means of controlling the hotplate burners.*

The hotplate has two high speed burners and two simmering burners which will accommodate pans between 100mm (4") and 240mm (9 ½") diameter. All pans should be positioned centrally over the burners.

TO USE THE HOTPLATE

1. Remove any items or spillage from the top of the lid and then raise it to its fully open position.*
2. Press the ignition button and then push in and turn the control knob of the chosen burner anti-clockwise to the large flame symbol. Continue to press the ignition button until the sparks light the gas.
3. Turn the control knob anti-clockwise to reduce the heat input. Only turn the control knob between the large flame symbol and the small flame symbol when adjusting the setting.
4. To turn off, turn the control knob fully clockwise to the symbol **O**.

DO NOT use the hotplate unless all pan supports are in position.

DO NOT use mis-shapen pans which may be unstable.

DO NOT use round base woks directly on the pan supports.

DO NOT use the glass lid as a working surface.*

Each burner is fitted with a spark ignitor for lighting the gas. To ensure rapid lighting of the burners every time they are used, the ignitors must be kept **clean and dry**. Remove any food spillage or cleaning materials from the ignitor using a small nylon brush such as a tooth brush. Access to the ignitor can be achieved by lifting off the loose burner parts carefully when the burners are cool.

When the hotplate burner bodies and caps are removed for cleaning, be careful not to drop any food particles or cleaning materials into the burner bases, to avoid the possibility of blocking the gas jets.

If aluminium based pans are used, a silvery deposit may appear on the top edge of the pan support fingers. See 'Care and Cleaning' section for cleaning information.

Models with Hob Gas Burner Safety Devices to Prevent Leaks *

These models can be identified by the presence of the device itself.

! Since the hob burners are equipped with a safety device, you must hold the control knob in for about 3-7 seconds after the burner has been lighted to allow the gas to pass until the safety thermocouple has heated.

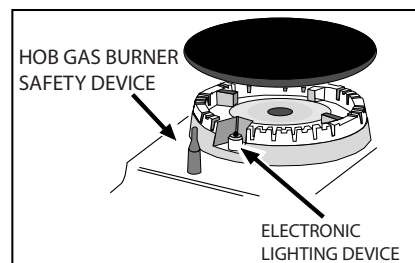

* (only available on certain models)

PLEASE PHONE US TO REGISTER YOUR APPLIANCE AND ACTIVATE YOUR PARTS GUARANTEE ON 08448 24 24 24

24

HOTPLATE

SAFETY REQUIREMENTS FOR DEEP FAT FRYING

1. Never fill chip pans more than one third full with oil or fat.
2. Never leave oil or fat unattended during the heating or cooling period.
3. Never heat fat or fry with a lid on the pan.
4. Always dry food thoroughly before frying, and lower it slowly into the hot oil or fat. Frozen foods in particular will cause frothing and spitting if added too quickly.
5. Always keep the outside of the pan clean and free from streaks of oil or fat.

HOW TO DEAL WITH A FAT FIRE

1. **Do not** move the pan.
2. Turn off the hotplate burners.
3. Smother the flames with a fire blanket or damp cloth to extinguish the fire. **Do not** use water or a fire extinguisher as the force of it may spread the burning fat or oil over the edge of the pan.
4. Leave the pan for at least 60 minutes before moving it.

SOLAR PLUS GRILL

CAUTION: Accessible parts may become hot when the grill is in use - children should be kept away.

Your cooker is not fitted with a conventional type of grill. The **solar plus** grill is designed to reduce your grilling times. It is quicker because it takes less time to warm up from cold. Conventional grills require 5 minutes pre-heat before food is placed beneath them, but for normal grilling the **solar plus** grill can be used from cold without any pre-heat. However, when toasting, optimum performance is achieved by preheating the grill for about 1 minute.

Note:

You will notice that the grill elements are protected by a wire mesh. This stops you from touching live parts.

DO NOT under any circumstances insert objects into the grill mesh as this could damage or break the element tubes OR if the grill is on cause an electric shock.

During use the mesh may become soiled. Do not attempt to clean it while the grill is still on. Turn the cooker off at the control unit and wait until it has cooled down before cleaning.

Care must be taken to ensure the grill mesh is not distorted - DO NOT store the grill pan handle on the grill pan grid when the rod shelf is in the top runner position.

There are two halves to the grill, one on the left and one on the right. You can choose to have both sides on or just the left side on. Turning the control knob clockwise, will switch both sides on. Turning it anticlockwise, will only switch the left side on. The numbers which are displayed indicate the heat setting.

Number **4** is the hottest and number **1** the coolest.

GRILLING SHOULD NOT BE UNDERTAKEN WITH THE GRILL/TOP OVEN DOOR CLOSED - This will cause overheating.

The grill will not operate unless the top oven control is in the ,0' **Off** position.

Grilling procedure

1. Open the grill/top oven door fully.
2. Position the telescopic runners and grill pan as recommended for the food being cooked (see the ,Guide to Grilling' chart, next page).
3. Place the grill pan into the telescopic runners, position centrally under the element.
4. Never line the grill pan with aluminium foil as this may cause overheating of fat in the grill pan.

NOTE: As the grill pan will be hot when the grill is in use, ALWAYS use oven gloves when removing the grill pan.

SOLAR PLUS GRILL

Guide to grilling successfully

Food	Pre-heat	Shelf Position from base of oven	Setting	Approx. Cooking Time	Comments
Toasting of Bread Products	1 min.	3 or 2	Maximum	3-5 minutes. Grill pan and grid.	Always use the grill pan in conjunction with the telescopic runner and ensure it is located correctly.
Small cuts of meat – Sausages, Bacon	None	3 or 2	Maximum for 4 minutes, then reduce to 3	10-15 minutes. Grill pan and grid.	
Chops, etc. Gammon Steaks, Chicken pieces	None	2	Maximum for 6-8 minutes. reduce to 3-2½	25-30 minutes. Grill pan and grid.	
Fish Whole:	None	2	Maximum	6-8 minutes.	
Fillets:	None	3 or 2	Maximum	In base of grill pan.	
Fish in breadcrumbs	None	3 or 2	3	10-15 minutes. Grill pan and grid.	
Pre-cooked Potato Products	None	3 or 2	3	10-12 minutes.	
Pizzas	None	3 or 2	3	10-15 minutes. Grill pan and grid.	
Browning of Food	1 min.	2	Maximum	5-7 minutes. Dish placed directly on shelf.	

NOTE:

Position 1 is bottom runner from the base of the oven

TOP OVEN - CONVENTIONAL COOKING

The heat for conventional cooking in the top oven is provided by the grill element and the element under the floor of the oven. It is ideal for the slow cooking of cheaper cuts of meat in casseroles etc. but can also be used for small joints of meat up to 1.5kg (3lb).

The operation of the controls is covered on "The Controls".

See cooking charts for temperatures and shelf positioning.

The top oven can be used either independently to cook small quantities of food or in conjunction with the main oven to provide additional cooking space.

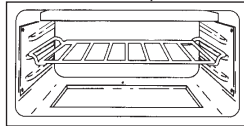

- The shelf should be positioned on the first or second runner from the bottom.

To use the oven proceed as follows:

- Set the top oven control to the required temperature, the top oven light will come on and wait for the thermostat light to go off, indicating that the oven has reached the right temperature.
- The food to be cooked should be placed in the centre of the shelf with a gap of at least 25mm (1in) between it and the grill element. This should avoid burning and ensure even cooking.
- **Do not place food or dishes on the floor of the oven.**

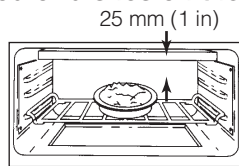

Platwarming in the top oven

Plates and dishes placed on shelf 1 of the top oven will be heated when the main oven is in use.

When the main oven is not in use, for instance when a meal is being cooked on the hob, place the plates and serving dishes on the shelf using the bottom runner and turn the top oven control to approximately 100°C. A maximum time of 10-12 minutes is all that is required to heat the plates and dishes.

NEVER operate the grill control when using the top oven for cooking or warming plates and dishes.

WARNING: DO NOT put delicate items china or items which could be affected by heat into the oven.

TOP OVEN TEMPERATURE CHARTS - MEAT



Meat	Pre-heat	Temperature °C	Time (approx.)	Position in Oven
Beef/ Lamb (slow roasting)	Yes	170/180	35 mins per 450g (1lb) + 35 mins over.	Runner 1 from bottom of oven.
Beef/ Lamb (foil covered)	Yes	190/200	35-40 mins per 450g (1lb)	
Pork (slow roasting)	Yes	170/180	40 mins per 450g (1lb) + 40 mins over	
Pork (foil covered)	Yes	190/200	40 mins per 450g (1lb)	
Veal (slow roasting)	Yes	170/180	40-45 mins per 450g (1lb) + 40 mins over	
Veal (foil covered)	Yes	190/200	40-45 mins per 450g (1lb)	
Poultry/Game (slow roasting)	Yes	170/180	25-30 mins per 450g (1lb) + 25 mins over	
Poultry/Game (foil covered)	Yes	190/200	25-30 mins per 450g (1lb)	
Casserole	Yes	150	2-2 1/2 hrs	

If using aluminium foil, never:

1. Allow foil to touch sides of oven.
2. Cover oven interior with foil.
3. Cover shelves with foil.

The most accurate method of testing the readiness of joints of meat or whole poultry is to insert a meat thermometer into the thickest part of a joint, or the thickest part of poultry thighs, during the cooking period. The meat thermometer will indicate when the required internal temp has been reached.

Beef - Rare:	60°C	Lamb:	80°C	Poultry:	90°C
Medium:	70°C	Pork:	80°C		
Well Done:	75°C	Veal:	75°C		

TOP OVEN TEMPERATURE CHARTS - BAKING

Food	Pre-heat	Temperature °C	Time in mins.	Position in Oven
Scones	Yes	210/220	10-15	Runner 2 from bottom of oven.
Small Cakes	Yes	180/190	20-25	Runner 2 from bottom of oven.
Victoria Sandwich	Yes	170/180	20-30	Runner 2 from bottom of oven.
Sponge Sandwich (fatless)	Yes	180/190	20-25	Runner 2 from bottom of oven.
Swiss Roll	Yes	200/210	10-15	Runner 2 from bottom of oven.
Semi-rich Fruit cakes	Yes	150/160	60-75 7 inch	Runner 1 from bottom of oven.
Rich Fruit cakes)	Yes	140/150	Time Dependent on size	Runner 1 from bottom of oven.
Shortcrust Pastry	Yes	190/200	Time Dependent on recipe	Runner 1 or 2 from bottom of oven.
Puff Pastry	Yes	200/210	Time Dependent on recipe	Runner 1 from bottom of oven.
Yorkshire Pudding	Yes	190/200	30-40	Runner 1 or 2 from bottom of oven.
Individual Yorkshire Puddings	Yes	200/210	20-30	Runner 2 from bottom of oven.
Milk Pudding	Yes	140/150	90-120	Runner 1 from bottom of oven.
Baked Custard	Yes	150/160	40-50	Runner 1 from bottom of oven.
Bread	Yes	200/210	30-45	Runner 1 from bottom of oven.
Meringues	Yes	100	150-180	Runner 2 from bottom of oven.

Note: If soft margarine is used for cake making, temperatures recommended by the manufacturers should be followed. Temperatures recommended in this chart refer to cakes made with block margarine only.

MAIN OVEN - THE PRECISION COOKING SYSTEM



The main oven of your new cooker is equipped with an intelligent electronic cooking system that gives you additional cooking performance, flexibility and features over traditional cooking products. The operation of the controls is covered on "the controls". See cooking charts for temperatures and shelf positioning.

Cooking temperature ranges

The intelligent cooking system will automatically suggest a suitable cooking temperature for several cooking modes. It is possible however to modify the suggested temperature within a range specific to each cooking mode.

Cook charts

All times and temperatures can be adjusted to suit personal taste. The information in the following charts is only a guide.

User adjustable temperature ranges by cooking mode:			
Mode	Minimum	Back Left	Maximum
Fan oven	200°C	80°C	230°C
Traditional	190°C	80°C	230°C
Roast meat	160°C	80°C	230°C
Roast chicken	190°C	80°C	230°C
Fish	180°C	80°C	230°C

MAIN OVEN - THE PRECISION COOKING SYSTEM

COOK CHART - Fan oven mode: 			
Meat	Pre-heat	Temperature	Cooking Time
Beef	No	160/180°C	20-25 minutes per 450g (1lb) + 20 minutes extra
Lamb	No	160/180°C	25 minutes per 450g (1lb) + 25 minutes extra
Pork	No	160/180°C	25 minutes per 450g (1lb) + 25 minutes extra
Chicken/Turkey (up to 4kg/8lb)	No	160/180°C	18-20 minutes per 450g (1lb) + 20 minutes extra
Turkey (4-5.5kg/8-12lb)	No	150/160°C	12-14 minutes per 450g (1lb) + 15 minutes extra
Notes: Internal Temperatures:			
	Beef	rare	60°C
		medium	70°C
		well done	75°C
	Lamb		80°C
	Pork		80°C
	Poultry		90°C
BAKING	Preheat	Temperature	Cooking Time
Scones	yes	210/220°C	10-15 minutes
Small cakes	no	170/180°C	15-25 minutes
Victoria sandwich	no	160/170°C	20-30 minutes
Fatless sponge sandwich	yes	180/190°C	10-20 minutes
Swiss roll	yes	190/200°C	10-15 minutes
Semi rich fruit cake	no	140/145°C	60-75 minutes
Rich fruit cake	no	130/140°C	depending on size
Shortcrust pastry	no	190/200°C	depending on recipe
Puff pastry	no	190/200°C	depending on recipe
Yorkshire pudding	yes	180/190°C	30-45 minutes
Yorkshire pudding:			
Individual	yes	190/200°C	20-25 minutes
Bread	yes	200/210°C	30-45 minutes
Meringues	no	80/90°C	180-240 minutes
Notes: Use up to 2 shelves when cooking (ensure they are evenly spaced) It is not necessary to preheat the oven for some items.			

PLEASE PHONE US TO REGISTER YOUR APPLIANCE AND ACTIVATE YOUR PARTS GUARANTEE ON 08448 24 24 24

MAIN OVEN - THE PRECISION COOKING SYSTEM





COOK CHART - Traditional mode: <input type="checkbox"/>				
Meat	Pre-heat	Temperature	Shelf Position	Cooking Time
Beef	yes	190/200°C	2 or 3	20-25 minutes per 450g (1lb) + 20 minutes extra
Beef (foil covered)	yes	190/200°C	2 or 3	35-45 minutes per 450g (1lb)
Lamb	yes	190/200°C	2 or 3	25-30 minutes per 450g (1lb) + 25 minutes extra
Lamb (foil covered)	yes	190/200°C	2 or 3	35-45 minutes per 450g (1lb)
Pork	yes	190/200°C	2 or 3	30-35 minutes per 450g (1lb) + 30 minutes extra
Pork (foil covered)	yes	190/200°C	2 or 3	40 minutes per 450g (1lb)
Poultry	yes	190/200°C	2 or 3	20-25 minutes per 450g (1lb) + 20 minutes extra
Poultry (foil covered)	yes	190/200°C	2 or 3	25-30 minutes per 450g (1lb)
Notes: Internal Temperatures:				
	Beef	rare		60°C
		medium		70°C
		well done		75°C
	Lamb			80°C
	Pork			80°C
	Poultry			90°C
BAKING	Preheat	Temperature		Cooking Time
Scones	yes	220°C	3	10-15 minutes
Small cakes	yes	180/190°C	3	15-25 minutes
Victoria sandwich	yes	170/180°C	3	20-30 minutes
Fatless sponge sandwich	yes	190/200°C	3	15-20 minutes
Swiss roll	yes	200/210°C	3	10-15 minutes
Semi rich fruit cake	yes	150/160°C	2	60-75 minutes
Rich fruit cake	yes	130/140°C	2	depending on size
Shortcrust pastry	yes	190/200°C	2 or 3	depending on recipe
Puff pastry	yes	190/200°C	2 or 3	depending on recipe
Yorkshire pudding	yes	190/200°C	3	35-45 minutes
Yorkshire pudding: Individual	yes	200/210°C	3	20-30 minutes
Bread	yes	200/210°C	3	30-45 minutes
Meringues	yes	80/90°C	3	180-240 minutes
Notes: For best results use one shelf. Preheat the oven before use.				

PLEASE PHONE US TO REGISTER YOUR APPLIANCE AND ACTIVATE YOUR PARTS GUARANTEE ON 08448 24 24 24

MAIN OVEN - THE PRECISION COOKING SYSTEM

COOK CHART - Roast Chicken mode: 				
Meat	Pre-heat	Temperature	Shelf Position	Cooking Time
Chicken	no	170°C	2 or 3	20 minutes per 450g (1lb)
Turkey	no	170°C	2 or 3	15-20 minutes per 450g (1lb)
Notes: Internal Temperatures:				
Poultry 90°C				
If the poultry is covered with foil, the cooking time will need to be extended.				

COOK CHART - Roast Meat mode: 				
Meat	Pre-heat	Temperature	Shelf Position	Cooking Time
Beef	no	170°C	2 or 3	20-25 minutes per 450g (1lb) + 20 minutes extra
Lamb	no	170°C	2 or 3	25 minutes per 450g (1lb) + 25 minutes extra
Pork	no	170°C	2 or 3	25 minutes per 450g (1lb) + 25 minutes extra
Notes: Internal Temperatures:				
Beef rare 60°C				
medium 70°C				
well done 75°C				
Lamb 80°C				
Pork 80°C				
If the meat is covered with foil, the cooking time will need to be extended..				

COOK CHART - Fish mode: 				
FISH	Pre-heat	Temperature	Shelf Position	Cooking Time
Fish steaks (open roasted)	yes	170°C	3	15-25 minutes
Whole fish (foil baked)	yes	180°C	2 or 3	20-25 minutes per 450g (1lb)
Whole stuffed fish (foil baked)	yes	180°C	2 or 3	25-30 minutes per 450g (1lb)

PLEASE PHONE US TO REGISTER YOUR APPLIANCE AND ACTIVATE YOUR PARTS GUARANTEE ON 08448 24 24 24

CARE AND CLEANING

WARNING: BEFORE CLEANING, SWITCH THE COOKER OFF AT THE MAINS COOKER CONTROL PANEL AND ALLOW IT TO COOL. IT IS ESSENTIAL THAT THE OVENS ARE CLEANED AND KEPT FREE FROM FATS, OIL AND GREASE.

- ! Never use steam cleaners or pressure cleaners on the appliance.
- ! Clean the glass part of the oven door using a sponge and a non-abrasive cleaning product, then dry thoroughly with a soft cloth. Do not use rough abrasive material or sharp metal scrapers as these could scratch the surface and cause the glass to crack.
- ! The accessories can be washed like everyday crockery (even in your dishwasher).

,Heat Clean' Liners

,Heat Clean' liners are covered with a special enamel which absorbs cooking soils. At higher temperatures the soiling is slowly destroyed. In most cases normal cooking at higher temperatures will permit this cleaning to take place automatically. However, if higher cooking temperatures are not used regularly then it may be necessary, in order to prevent heavy soiling, to run the oven at maximum temperature for at least two hours, from time to time.

The ,Heat Clean' liners can be washed in warm soapy water followed by rinsing in clear water. Dry well with a soft cloth.

NOTE: Do not use enzyme washing powder, harsh abrasives or chemical oven cleaners of any kind.

Oven Fittings

The oven shelves can be cleaned either in a dishwasher or by using a fine steel wool soap pad. The grill and meat pans can be cleaned in warm soapy water using a fine steel wool soap pad to remove stubborn stains or in a dishwasher.

They should be cleaned after each use.

Oven Interiors

To clean the oven interiors remove all the oven fittings and where applicable the ,Heat Clean' liners.

All types of oven cleaners can be used, but do not allow abrasive cleaners or oven spray to come into contact with the ,Heat Clean' liners.

Use a fine steel wool soap pad to remove stubborn stains.

Oven Door Cleaning

The inner door glass panel can be removed for easy cleaning, see CLEANING THE DOORS section of "Care and Cleaning".

Hotplate, Burner Caps and Pan Supports

To clean, use a cloth wrung out in soapy water. Stubborn stains can be removed with a cream paste, liquid cleaner or by rubbing with fine steel wool soap pads.

NOTE: Check that the cleaning agent is approved by the Vitreous Enamel Association.

Hotplate Burner Bodies

Use a nylon brush to remove any cleaning materials, water or dirt from the hotplate burner bodies.

Cooker Exterior

CARE AND CLEANING

The outside of the cooker should be cleaned regularly to keep it looking like new. Wipe over with a soft cloth wrung out in warm water and dry with a soft clean cloth. You can use mild non abrasive cleaners but always read the manufacturer's instructions first. Always test their suitability on a small area of the cooker not noticeable in normal use.

NOTE: DO NOT use scouring pads or abrasive cleaners as they may scratch the surface.

Wear protective gloves when cleaning any part of your cooker.

Door and Control Panel (Glass)

Regularly wipe with a clean, damp cloth and polish with a clean, dry cloth.

Door and Control Panel Trims (Stainless Steel)

Regularly wipe with a clean, damp cloth and polish with a clean, dry cloth.

Solar Plus Grill

To clean the solar plus grill, use a clean, damp, soapy cloth and wipe over. If stubborn stains remain, gently clean with a well soaped nylon scouring pad and wipe over with a damp cloth.

NOTE: DO NOT use metal cleaning utensils, wire wool or proprietary oven cleaners on the grill element mesh.

WARNING: TO AVOID ELECTRIC SHOCK, BEFORE REPLACING THE OVEN LIGHT, SWITCH THE COOKER OFF AT THE COOKER CONTROL UNIT (and allow to cool if the oven has been used).

Replacement of the Oven Light

Unscrew the glass cover, using a suitable cloth to protect the fingers and remove carefully. Unscrew the existing light bulb, and remove. Screw the new bulb into position and replace the glass cover, with metal washer, until positioned securely.

Do not use the oven lamp as/for ambient lighting.

CARE AND CLEANING

CLEANING THE DOORS

Take particular care not to damage the inner surface of the door inner glass that is coated with a heat reflective layer. Do not use scouring pads, or abrasive powder, which will scratch the glass.

Ensure that the glass panel is not subjected to any sharp mechanical blows.

Stubborn stains can be removed by using a fine steel wool soap pad. For slight soiling the inner glass panel may be cleaned, while still warm, without removing it from the door. After cleaning, rinse and dry with a soft cloth.

SIDE OPENING DOORS

Cleaning the door glass is the same as the drop down doors, except take care to support the weight of the inner glass when removing and refitting.

DROP DOWN DOORS

Remove the door inner glass as follows.

1. Open the door fully and remove the extrusion end caps (This should be done by hand but if it proves too difficult, simply lift the inner glass to ease the end caps out of position).

NOTE: If you need to use a tool - be careful not to damage the extrusion or end cap.

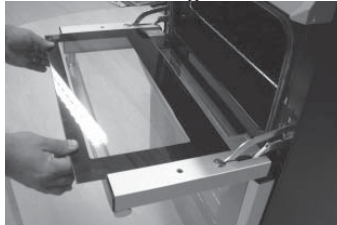

2. Carefully slide the inner glass towards you and withdraw it from its locating slots. Ensure that the door is not allowed to slam shut, due to the reduction in door weight. Clean the glass as described above.
3. The inside of the outer door glass can now be cleaned while still fitted to the cooker.

Refit the door inner glass as follows.

1. Open the door fully.
2. Locate the inner door glass into its slots, so that the printing is readable from the face nearest the oven in the closed position and the widest black band is towards the bottom of the door. The inner door glass has a special reflective coating on one side, in order to minimise surface temperatures and energy consumption during use, it is important it is fitted correctly.
3. Carefully slide the glass into its slots as far as it will go and replace the end caps.

NEVER OPERATE THE COOKER WITHOUT THE INNER DOOR GLASS IN POSITION.

SOMETHING WRONG WITH YOUR COOKER

Before contacting your nearest Service Centre/Installer, check the problem guide below; there may be nothing wrong with your cooker.

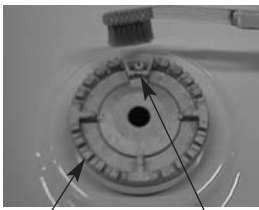
PROBLEM	CHECK
<p>Burner will not light:</p> <p style="text-align: center;"><i>Hotplate burner:</i></p>  <p style="text-align: center;">Burner ports Ignitor</p>	<p>If all burners fail to ignite: Check that sparks appear at the burners; a clicking noise should be heard. If not;</p> <p>Check that the electricity supply is turned on. If the electricity supply has failed, all burners can be lit by a match.</p> <p>If only one burner fails to ignite: Check that the burner is dry and that spillage of food or cleaning fluid remains are not affecting the ignitor or burner ports. Clean away any debris with a dry nylon brush such as an old toothbrush. If a wire wool pad has been used for cleaning around the burner ensure the ignitor is free from any stray strands. Any water on the burner should be dried with a cloth or kitchen towel.</p> <p>On the hotplate make sure that all the burner parts are correctly seated.</p>
<p>Slight odour or small amount of smoke when grill / oven used first time.</p>	<p>This is normal and should cease after a short period.</p>
<p>Nothing works</p>	<p>If you find that the timer display is blank, then it is likely that there is no electricity supply to your oven. Check: (i) That the main cooker wall is switched on (ii) Other appliances, to see if you have had a power cut (iii) The main circuit breaker for the property</p>
<p>Top oven, grill and main oven do not work</p>	<p>Operating the cooker under the following conditions may cause a safety device to operate: (a) Grilling with the door closed - Always grill with the door fully open (b) Grilling for an excessively long period at maximum setting - see Grilling guide. Switch off appliance and allow to cool for approx 30 mins. Switch the cooker back on and check that the Grill, Top oven and Main Oven are now operating.</p>
<p>Grill keeps turning on and off.</p>	<p>When the Grill control is operated, the Grill will cycle on and off, this is normal and not a fault.</p>
<p>The oven is not working and showing F01 to F68 code in the display</p>	<p>Your appliance has developed a fault which will require assistance from our service department.</p>

PLEASE PHONE US TO REGISTER YOUR APPLIANCE AND ACTIVATE YOUR PARTS GUARANTEE ON 08448 24 24 24

SOMETHING WRONG WITH YOUR COOKER



PROBLEM	CHECK
Timer is flashing '00.00' 	The power supply to your oven has possibly been interrupted, but has now come back on again. Reset the timer to the correct time of day using the instructions given in the timer section of the book.
Oven temperatures too high or low	Check temperature and shelf positions are as recommended in the Oven Temperature Charts. It may be necessary to increase or decrease the recommended temperature slightly to suit your taste.
Oven does not cook evenly	Check: (a) Temperature and shelf positions are as recommended in the Oven Temperature Charts (b) Oven utensils being used allow sufficient air flow around them.
Oven light does not work	The oven light is not covered by the guarantee. The part is easily changed (see section 'Replacement of Oven Light'). A new light bulb may be obtained from our Parts department see Key Contacts, back page.
Draught from beneath control panel	A gentle flow of air will be blown from beneath the control panel when the appliance is used. If the appliance is still warm, this cooling fan may run on, or restart itself when all controls have been turned off. The fan will stop once the appliance has been cooled. This is normal and not a fault.
Steam / Condensation in the oven after use.	Steam is a by - product of cooking any food with a high water content. To help minimise always: (a) Try to avoid leaving food in the oven to cool after being cooked. (b) Use a covered container, wherever possible.
The oven is not working and showing F01 to F68 code in the display	Your appliance has developed a fault which will require assistance from our service department.

Disposal of your product

To minimise the risk of injury to children please dispose of your product carefully and safely. Remove all doors and lids. Remove the mains cable (where fitted) by cutting off flush with the appliance and always ensure that no plug is left in a condition where it could be connected to the electricity supply.

To help the environment, Local Authority instructions should be followed for the disposal of your product.



Disposal of old electrical appliances

The European Directive 2002/96/EC on Waste Electrical and Electronic Equipment (WEEE), requires that old household electrical appliances must not be disposed of in the normal unsorted municipal waste stream. Old appliances must be collected separately in order to optimise the recovery and recycling of the materials they contain and reduce the impact on human health and the environment.

The crossed out „wheeled bin” symbol on the product reminds you of your obligation, that when you dispose of the appliance it must be separately collected.

Consumers should contact their local authority or retailer for information concerning the correct disposal of their old appliance.

PLEASE PHONE US TO REGISTER YOUR APPLIANCE AND ACTIVATE YOUR PARTS GUARANTEE ON 08448 24 24 24



After Sales Service

No one is better placed to care for your Hotpoint appliance during the course of its working life than us - the manufacturer.

Essential Contact Information

Hotpoint Service

We are the largest service team in the country offering you access to 400 skilled telephone advisors and 1100 fully qualified engineers on call to ensure you receive fast, reliable, local service.

UK: 08448 224 224

Republic of Ireland: 0818 313 413

www.hotpoint.co.uk

Please note: Our advisors will require the following information:

Model number

Serial number

Parts & Accessories

We supply a full range of genuine replacement parts as well as accessory products that protect and hygienically clean your appliance to keep it looking good and functioning efficiently throughout its life.

UK: 08448 225 225

Republic of Ireland: 0818 313 413

www.hotpointservice.co.uk

Appliance Registration

We want to give you additional benefits of Hotpoint ownership. To activate your FREE 5 year parts guarantee you must register your appliance with us.

UK 08448 24 24 24

Republic of Ireland: 01 230 0800

www.hotpointservice.co.uk

As part of Hotpoint's continued commitment to helping the environment, Hotpoint reserves the right to use quality, recycled components to keep down customer costs and minimise material wastage.

Indesit Company UK Limited, Morley Way, Peterborough, PE2 9JB

Indesit Company, Unit 49 Airways Industrial Estate, Dublin 17

PLEASE PHONE US TO REGISTER YOUR APPLIANCE AND ACTIVATE YOUR PARTS GUARANTEE ON 08448 24 24 24



Guarantee

12 months Parts and Labour Guarantee

Your appliance has the benefit of our manufacturer's guarantee, which covers the cost of breakdown repairs for twelve months from the date of purchase.

This gives you the reassurance that if, within that time, your appliance is proven to be defective because of either workmanship or materials, we will, at our discretion, either repair or replace the appliance at no cost to you.

The guarantee is subject to the following conditions:

- The appliance has been installed and operated correctly and in accordance with our operating and maintenance instructions.
- The appliance is only used on the electricity or gas supply printed on the rating plate.
- The appliance has been used for normal domestic purposes only.
- The appliance has not been altered, serviced, maintained, dismantled or otherwise interfered with by any person not authorised by us.
- Any repair work must be undertaken by us or our appointed agent.
- Any parts removed during repair work or any appliance that is replaced become our property.
- The appliance is used in the United Kingdom or Republic of Ireland.

The guarantee does not cover:

- Damage resulting from transportation, improper use, neglect or interference or as a result of improper installation.
- Replacement of any consumable item or accessory. These include but are not limited to: plugs, cables, batteries, light bulbs, fluorescent tubes and starters, covers and filters.
- Replacement of any removable parts made of glass or plastic.

THE GUARANTEE WILL NOT APPLY IF THE APPLIANCE HAS BEEN USED IN COMMERCIAL OR NON-DOMESTIC PREMISES.

5 Year Parts Guarantee

Hotpoint also offers you a FREE 5 year parts guarantee. This additional guarantee is conditional on you registering your appliance with us and the parts being fitted by one of our authorised engineers. There will be a charge for our engineer's time. To activate the extra parts warranty on your appliance, simply call our registration line on **08448 24 24 24 (ROI 01 230 0800)**

Extended Guarantees

We offer a selection of protection plans that enable you to fully cover yourself against the expense of repair bills for the life of your policy. To find the ideal plan for you please call our advice line on **08448 226 226 (ROI 01 230 0233)**

Free Helpdesk Service

We have a dedicated team who can provide free advice and assistance with your appliance if you experience any technical difficulties within the first 90 days of ownership. Simply call our Hotpoint Service Hotline on **08448 224 224 (ROI 0818 313 413)** for telephone assistance, or, where necessary, to arrange for an engineer to call.

PLEASE PHONE US TO REGISTER YOUR APPLIANCE AND ACTIVATE YOUR PARTS GUARANTEE ON 08448 24 24 24

PLEASE PHONE US TO REGISTER YOUR APPLIANCE AND ACTIVATE YOUR PARTS GUARANTEE ON 08448 24 24 24

Free Manuals Download Website

<http://myh66.com>

<http://usermanuals.us>

<http://www.somanuals.com>

<http://www.4manuals.cc>

<http://www.manual-lib.com>

<http://www.404manual.com>

<http://www.luxmanual.com>

<http://aubethermostatmanual.com>

Golf course search by state

<http://golfingnear.com>

Email search by domain

<http://emailbydomain.com>

Auto manuals search

<http://auto.somanuals.com>

TV manuals search

<http://tv.somanuals.com>