



Instructions for Installation and Use

Model no.
MWHZ33

To the Installer

**Before installation fill in the product details on the back cover of this book.
The information can be found on the rating plate.**

To the User

**You must read the instructions prior to installing and using the appliance and
then retain them for future reference.**

Data and instruction for Performance Tests according to IEC 60705 and EN 60705 (1999-04)

The International Electrotechnical Commission SC 59H, has developed a Standard for comparative testing of heating performances of microwave ovens.

We recommend the following for this oven:

Test Nr. on standard	Item	Duration	Function	Power Level	Oven temp.	Weight	Standing time	Note
12.3.1	Egg custard	16 min.	only mw	1000 W	-	750 gr	5 min	The upper surface shall be evaluated after the standing time. The inner custard evaluation shall be conducted after two hours.
12.3.2	Sponge cake	6 min.	only mw	1000 W	-	475 gr	5 min	Use the borosilicate glass container stated in the Standard (max. dia. 210 mm) or a Pyrex® glass container dia. 210 mm, height 50 mm and wall thick 6 mm. Put the container on the low wire rack placed on the turntable.
12.3.3	Meat loaf	20 min.	only mw	750 W	-	900 gr	5 min	Cover the container with cling film and pierce the film. Use the rectangular borosilicate glass container stated in the Standard or the Arcopal® Cat. nr. Z1/B8 (01)10460-1.
13.3	Defrosting minced meat	11 min.	only mw		-	500 gr	15 min	Place the frozen load directly on the turntable (1). Turn the load upsidedown after half of the defrosting time.
12.3.4	Potato gratin	20 min.	combi mw + fan (simult.)	750 W	190°C	1100 gr	5 min	Use the borosilicate glass container stated in the Standard (max. dia. 210 mm) or a Pyrex® glass container dia. 210 mm, height 50 mm and wall thick 6 mm. Put the container on the lower wire rack (F) placed on the turntable. Do not preheat the oven.
12.3.5	Cake	30 min.	combi mw + fan (simult.)	150 W	160°C	710 gr	5 min	Use the borosilicate glass container stated in the Standard (max dia. 210 mm) or a Pyrex® glass container dia. 210 mm, height 50 mm and wall thick 6 mm. The oven shall be preheated (in FAN ONLY function) with the lower rack (F) placed on the turntable. Once preheated, place the container on the lower rack (F).
12.3.6	Chicken	40 min.	combi mw + fan (simult.)	750 W	190°C	1200 gr	5 min	The following instruction shall be strictly observed for this type of load: put the chicken in a pyrex® glass container dia 210 mm, height 50 mm and wall thickness of 6 mm. Put the container on the lower wire rack (F) placed on the turntable.

CONTENTS

CHAP. 1 – GENERAL	1.1 Description.....page	4
	1.2 Description of the control pannelpage	5
	1.3 Building-inpage	6
	1.4 Important safety warnings.....page	9
	1.5 Technical data.....page	10
	1.6 Installation and Electrical Connectionpage	10
	1.7 Accessories supplied.....page	11
	1.8 Ovenware to use.....page	12
	1.9 General rules / suggestions for using the oven.....page	13
CHAP. 2 – USING THE CONTROLS AND SETTING THE MODES		
	2.1 Setting the clock.....page	14
	2.2 Programming the cooking.....page	15
	2.3 Automatic sequence for defrosting and cooking.....page	17
	2.4 Recalling the pre-memorised recipes ("Automatic Functions" keys).....page	18
	2.5 Quick Reheat.....page	18
	2.6 Child lock-out feature.....page	18
	2.7 Turntable stop key.....page	18
	2.8 Function "Memotime".....page	18
CHAP. 3 – USING THE PASTA FUNCTION		
	3.1 Introduction.....page	20
	3.2 Using the cooker and setting the controlspage	20
	3.3 Important warningspage	23
CHAP. 4 – USING THE OVEN: SUGGESTIONS AND COOK CHARTS		
	4.1 Defrosting.....page	24
	4.2 Reheating.....page	25
	4.3 Cooking starters, pasta and entrees.....page	26
	4.4 Cooking meat.....page	26
	4.5 Cooking side dishes and vegetables.....page	27
	4.6 Cooking fish.....page	28
	4.7 Cooking desserts and cakes.....page	28
	4.8 Reheating/cooking using the "Automatic Functions" keys.....page	29
	4.9 Simultaneous cooking on 2 levels.....page	30
CHAP. 4 – CLEANING AND MAINTENANCE		
	4.1 Cleaning.....page	32
	4.2 Maintenance.....page	33

CHAPTER 1 – GENERAL

1.1 DESCRIPTION

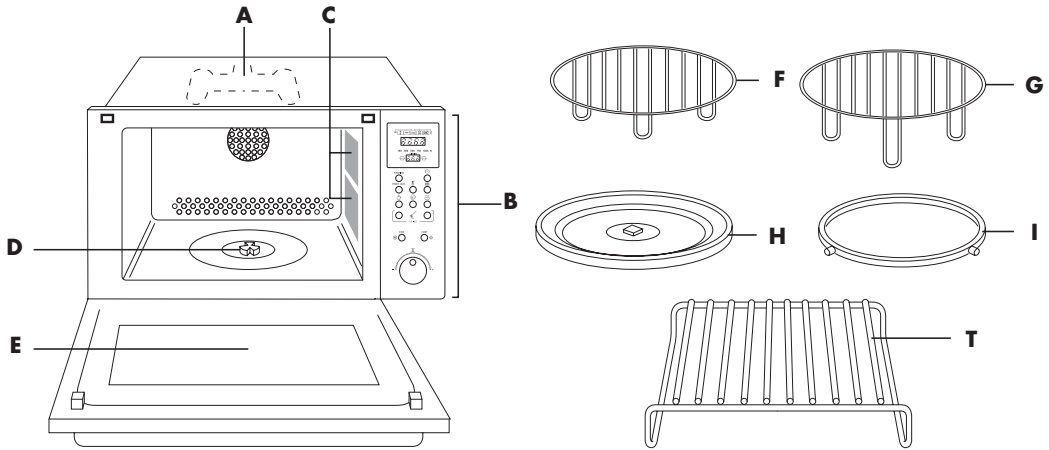

- A Grill heating element
- B Control panel
- C Microwave outlet cover
- D Turntable spindle
- E Inside of door
- F Low wire rack

- G High wire rack
- H Turntable
- I Turntable support
- L Rectangular grill

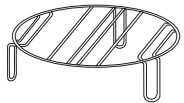

Spacer wire rack at medium height level that makes it possible to cook, defrost and reheat with microwave only function, two food dishes at the same time (simultaneous insertion of two plates or pans). Consult the instructions given on page 55.

PASTA COOKER

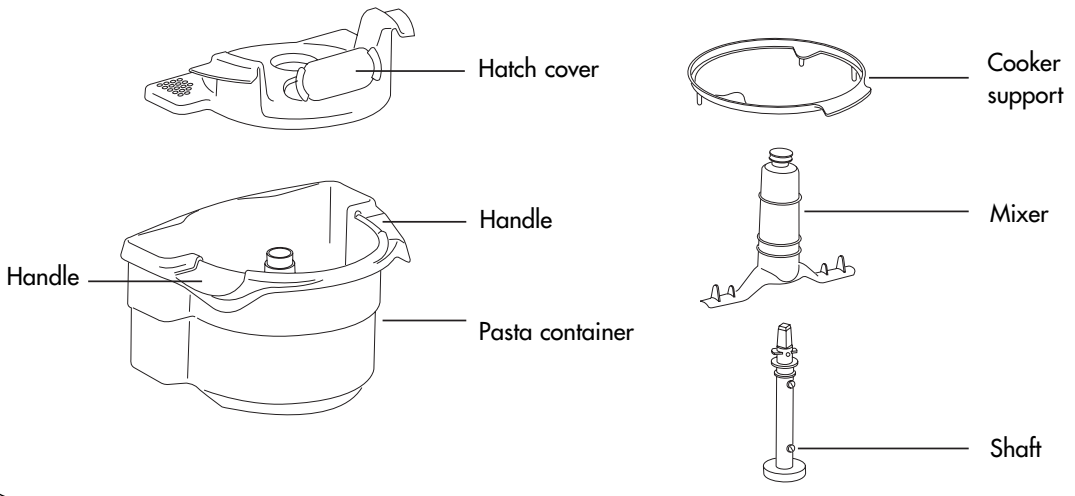

1.2 DESCRIPTION OF THE CONTROL PANEL

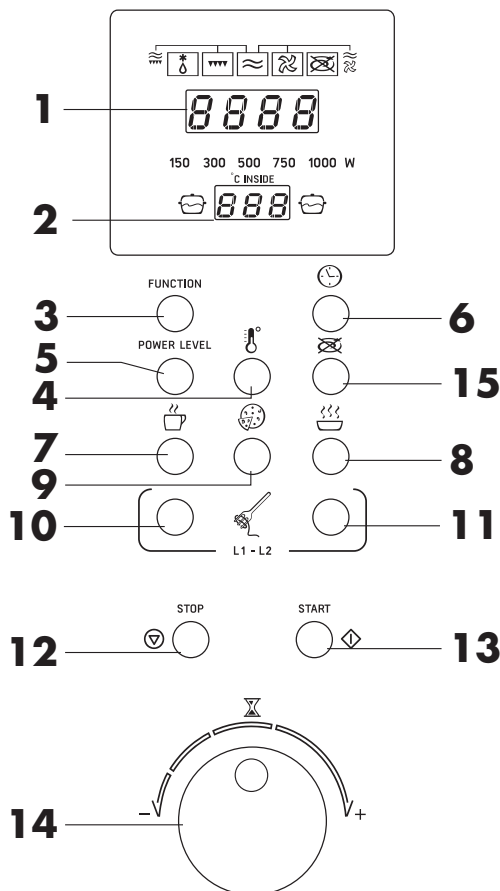

1. Time and mode display
2. Oven temperature display
3. **FUNCTION** key: mode selection
4. key: oven temperature selection
5. **POWER LEVEL** key: microwave power level selection
6. key: setting the clock
- 7 - 8 - 9 "Automatic Functions" keys: pre-memorised rapid cooking
- 10 - 11 "Pasta" buttons
12. **STOP** key: interruption of cooking and cancellation of settings
13. **START** key: start of cooking and rapid reheating
14. knob: setting of time and length of cooking
15. Turntable stop key

1.3 BUILDING-IN

Inside the oven there is a plastic bag with fixing material. Take this bag out of the oven.

1. Remove the two screws (X) from the fastening bar under the microwave oven.
2. Fasten metal strip (A) using the two screws (X) that have just been removed.

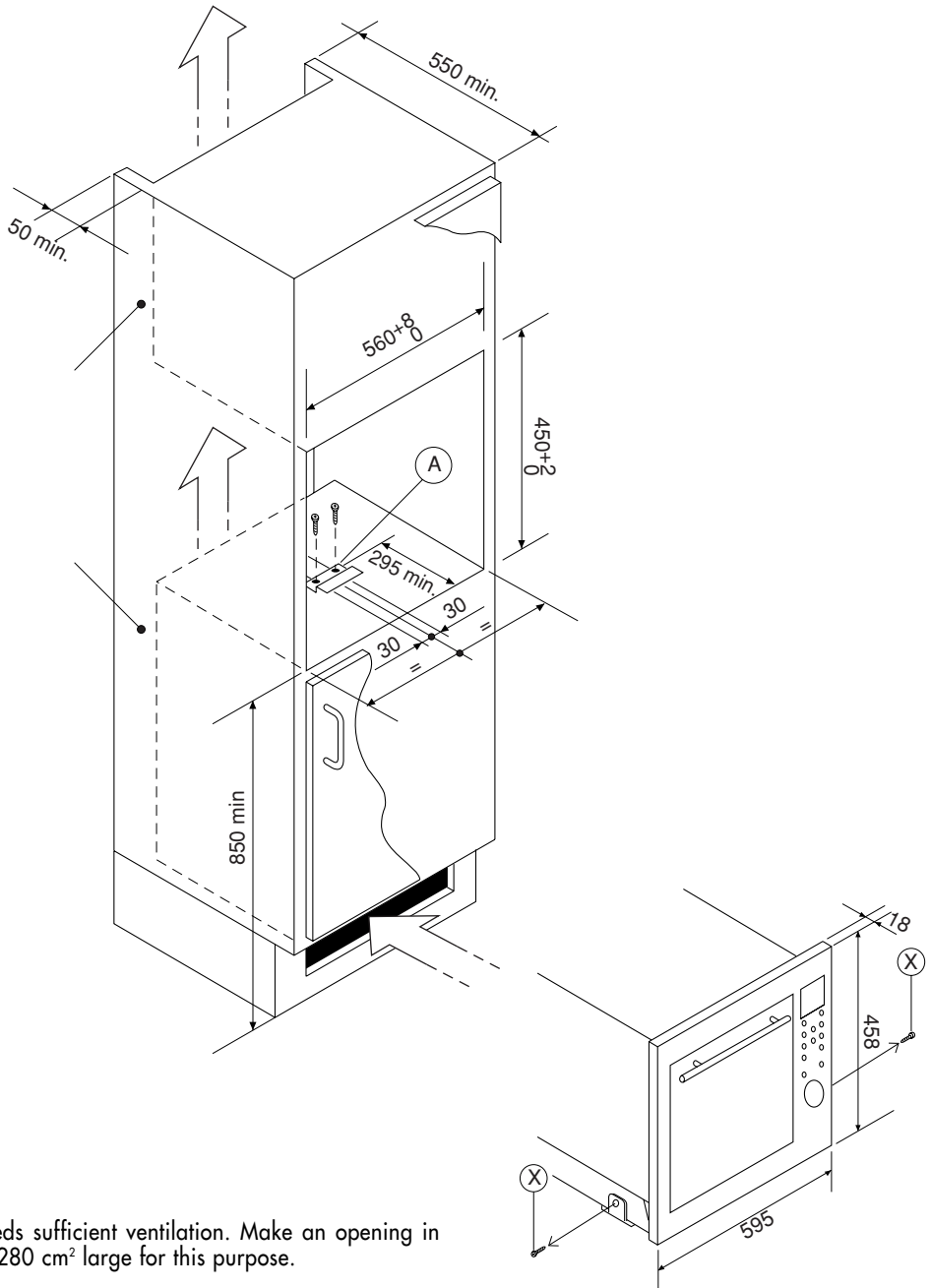

The appliance needs sufficient ventilation. Make an opening in the plinth at least 280 cm² large for this purpose.

3. Fit the fastening bar (**B**) at the correct position in the recess. Make sure that there is the same amount of free space at each side of the fastening bar. Fasten the bar with the screws (**H**).

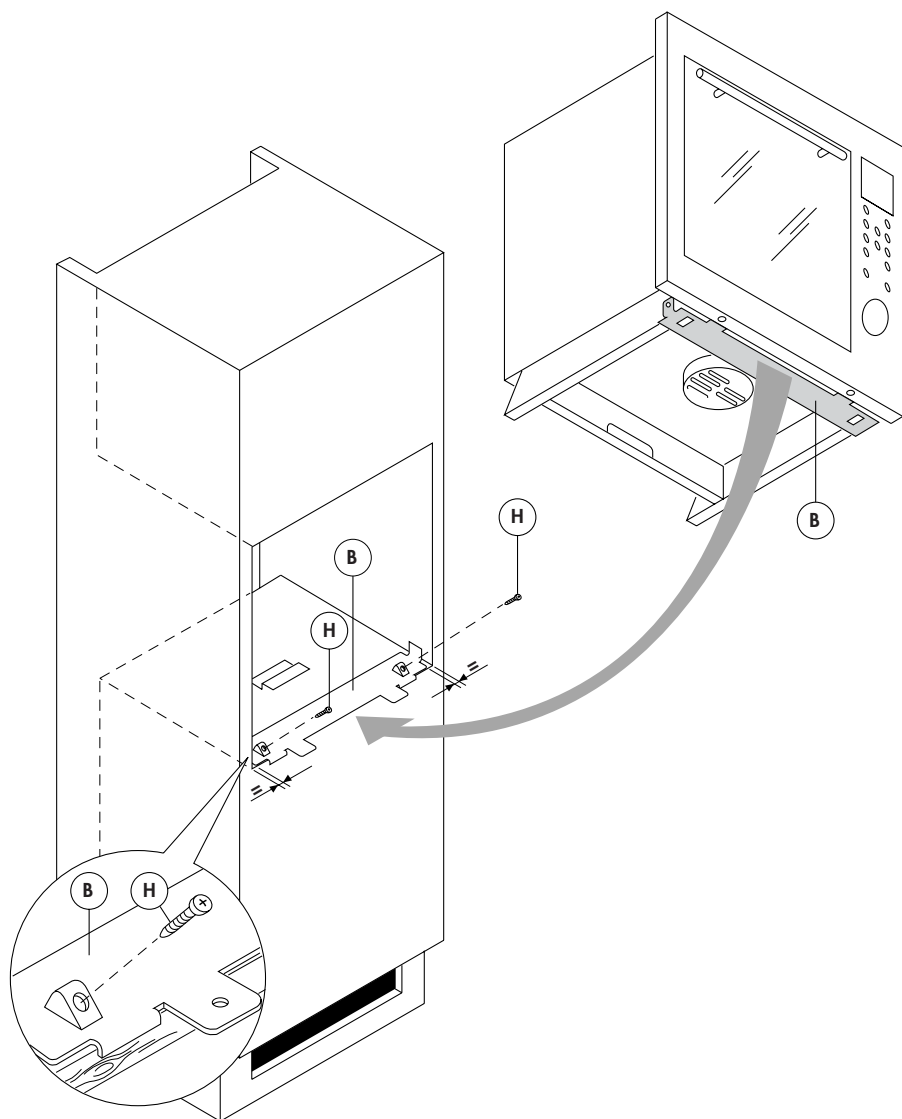

Fix the fastening bar such that the two lips stick out over the edge of the bottom of the recess and rest against it at the front.

4. Open the lid of the smoke discharge (C) fully.
5. Slide the appliance into the recess. Slide the front of the appliance over the fastening bar (B). Keep sliding it until the front of the oven (G) is resting against the cupboard and the holes (D) under the oven are aligned with the holes (E) in the fastening bar (B).
6. Fasten the appliance to the fastening bar (B) using the screws (F).

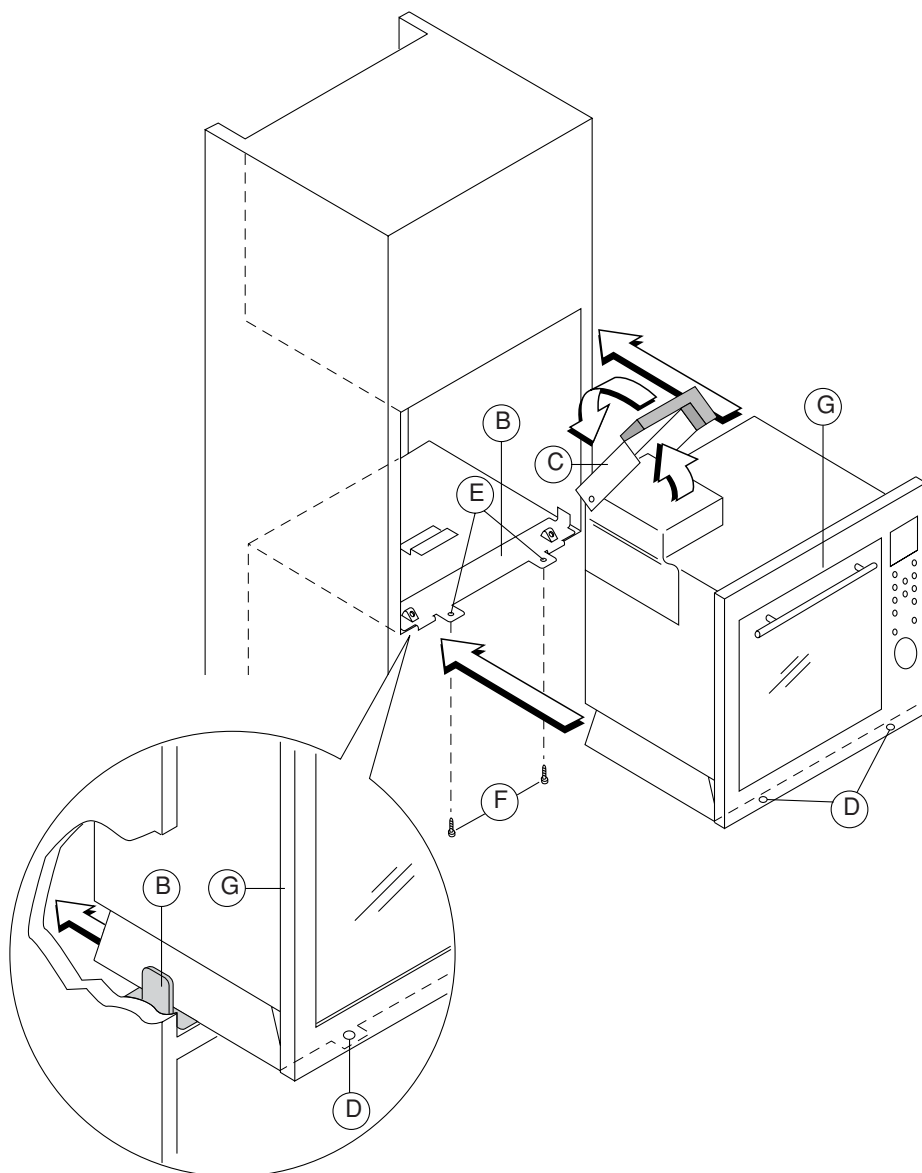

Important: After the installation has been performed, the power supply cable and the power socket must be easy to access.

1.4 FOR YOUR SAFETY

Read these instructions carefully and keep for future reference.

N.B. This oven has been designed to defrost, heat and cook food in the home. It must never be used for other purposes, modified or tampered with in any way.

- 1) **WARNING:** If the door or door seals are damaged, the oven must not be operated until it has been repaired by a competent person (trained by the manufacturer or by its Customer Service).
- 2) **WARNING:** It is hazardous for anyone other than a competent person to carry out any service or repair operation which involves the removal of a cover which gives protection against exposure to microwave energy.
- 3) **WARNING:** Liquids and other foods must not be heated in sealed containers since they are liable to explode. Eggs in their shell and whole hard-boiled eggs should not be heated in microwave ovens since they may explode even after microwave heating has ended.
- 4) **WARNING:** Children should not be allowed to play with the appliance or tamper with its controls. Do not allow children near the oven when it is in operation, as this may result in severe burns.
- 5) Do not attempt to operate the oven with the door open by tampering with the safety devices.
- 6) Do not operate the oven if objects for any kind get stuck between the front panel of the oven and the door. Always keep the inside of the door (E) clean, using a damp cloth and non-abrasive detergents. Do not allow dirt or remains of food to accumulate between the front panel of the oven on the door.
- 7) The following warnings must be observed when the door is open: Do not place heavy objects on the door or pull the handle downwards any further. Never place hot containers or pans (e.g. just taken off the stove) on the door.
- 8) If the power cable becomes damaged, this must be substituted only by specialised personnel authorised or by the manufacturer.
- 9) If smoke is observed, switch off or unplug the appliance and **KEEP THE DOOR CLOSED** in order to stifle any flames.
- 10) Only use utensils that are suitable for use in microwave ovens. In order to avoid overheating and the consequent risk of fire, it is advisable to supervise the oven when cooking food in disposable containers made of plastic, cardboard or other inflammable materials, and when heating small quantities of food.
- 11) Never place the turntable in water after it has been heated for a long time. The high thermal shock resulting would break the turntable.
- 12) You must not either preheat or operate the microwave oven in any way without food in the oven. Sparking can occur if you were to ignore this warning.
- 13) Before using this oven, make sure that the utensil and containers chosen are suitable for microwave oven use (see the section on "Glassware and Similar Items").
- 14) When heating liquids (water, coffee, milk, etc.) it is possible that the contents may suddenly start to boil and spill violently as a result of delayed boiling, causing scalding. To avoid this happening, you should place a heat-resistant plastic spoon or a glass rod in the container before starting to heat liquids. Anyway, care should be taken when handling the container.
- 15) Do not heat spirit with a high alcohol content, nor large quantities of oil, as these could catch fire !
- 16) The contents of feeding bottles and baby food jars should be stirred or shaken and the temperature should be checked before consumption in order to avoid burns. It is also advisable to stir or shake the food in order to ensure that it has an even temperature. When using commercially available bottle sterilisers, before turning the oven on, **ALWAYS** make sure the container is filled with the quantity of water indicated by the manufacturer.

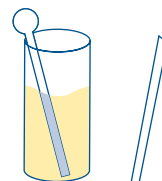
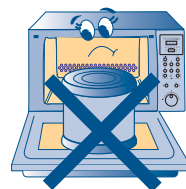

When the oven is used for the first time it is possible that, for a period of approx. 10 minutes, it may produce a "new" smell and a small amount of smoke. This is only a result of protective substances applied to the heating element.

1.5 TECHNICAL DATA

ENERGY CONSUMPTION ventilated oven only function (CENELEC HD 376 norms)

To reach 200°C	0,35 kWh
To maintain a temperature of 200°C for an hour	1,15 kWh
Total consumption	1,5 kWh

• **OUTPUT POWER - MICROWAVE: 1000 W (IEC705)**

For additional data, consult the data plate placed on the front side of the appliance.

This appliance complies to E.E.C. directive no. 89/336 and 92/31 regarding Electromagnetic Compatibility, and to directive 89/109/E.E.C. regarding materials which come into contact with food.

OUTPUT POWER

The microwave output power is written on the rating plate placed on the control panel (see "MICRO OUTPUT"). When you consult the tables, always look up your oven's output power. It will be useful also when you are consulting cook-books intended for use with microwave ovens.



ONLY FOR SOME MODELS: The microwave output power is also indicated inside this symbol, placed on the door.

(ONLY FOR U.K.) The letter indicates the heating category to which your oven belongs: some pre-cooked food packages (frozen or chilled) give heating instructions corresponding to the various categories. Follow those instructions related to the category indicated for your oven.

1.6 INSTALLATION AND ELECTRICAL CONNECTION

- 1) Remove all the accessories and wash them.
- 2) Clean the inside with a soft, damp cloth.
- 3) Check that there is no damage as a result of transportation, and in particular that the door opens and closes properly.
- 4) Place the support (I) in the centre of the circular groove and fix the turntable (H) to it. The spindle (D) should be inserted in the corresponding groove in the centre of the turntable.
- 5) After the installation has been performed, the power supply cable and the power socket must be easy to access.
- 6) Only a qualified electrician may install or relocate a socket outlet.
- 7) Only connect the appliance to a power socket with a power capacity of at least 16A. Also make sure that the main switch installed in your home has a minimum power capacity of 16A in order to avoid it suddenly tripping while the oven is on.
- 8) Before use, check that the power supply voltage is the same as the one shown on the rating label and that the power outlet is properly earthed: the manufacturer disclaims any liability in the event of non-compliance with this safety regulation.

ELECTRICAL CONNECTION (U.K. ONLY)

- A) If your appliance comes fitted with a plug, it will incorporate a 13 Amp fuse. If it does not fit your socket, the plug should be cut off from the mains lead, and an appropriate plug fitted, as below.
WARNING: Very carefully dispose of the cut off plug after removing the fuse: do not insert in a 13 Amp socket elsewhere in the house as this could cause a shock hazard.
With alternative plugs not incorporating a fuse, the circuit must be protected by a 15 Amp fuse.

**WARNING - THIS APPLIANCE MUST BE EARTHED
IMPORTANT**

The wires in the mains lead are coloured in accordance with the following code:

Green and yellow:	Earth
Blue:	Neutral
Brown:	Live



If the plug is a moulded-on type, the fuse cover must be re-fitted when changing the fuse using a 13 Amp Asta approved fuse to BS 1362. In the event of losing the fuse cover, the plug must NOT be used until a replacement fuse cover can be obtained from your nearest electrical dealer. The colour of the correct replacement fuse cover is that as marked on the base of the plug.

- B) If your appliance is not fitted with a plug, please follow the instructions provided below:

As the colours of the wires in the mains lead may not correspond with the coloured markings identifying the terminals in your plug, proceed as follows:

The green and yellow wire must be connected to the terminal in the plug marked with the letter E or the earth symbol  or coloured green or green and yellow.
The blue wire must be connected to the terminal marked with the letter N or coloured black.
The brown wire must be connected to the terminal marked with the letter L or coloured red.

1.7 ACCESSORIES SUPPLIED

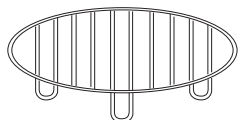

LOW WIRE RACK

Fan Oven Only mode:

for all types of traditional cooking, especially cakes.

Combined microwave and fan oven mode and microwave + grill:

for rapid cooking of meat, potatoes, some leavened cakes and desserts and gratinéed dishes (for example, baked lasagne).

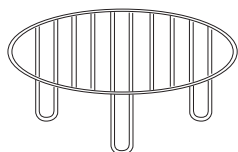

HIGH WIRE RACK

Grill Only mode:

for all types of grilled food.

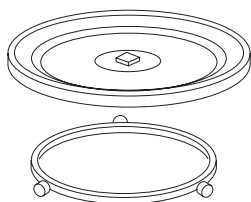

TURNTABLE and TURNTABLE SUPPORT

The turntable and its support are used for all the modes, except for the pasta mode.

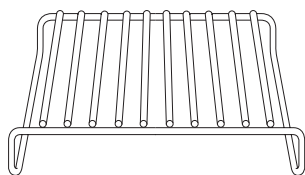

RECTANGULAR RACK

Only for ventilated oven:

For all types of traditional cooking in large sized rectangular casserole dishes. Naturally, the food must be stirred and turned during the cooking process. Position this rack directly on the bottom of the oven. The rotating plate (H) can be left in place. This rack cannot be used for microwave cooking.

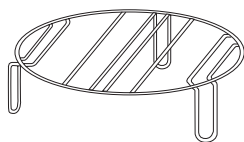

MEDIUM WIRE RACK

Microwave-only function:

For all types of cooking on two levels AT THE SAME TIME (e.g., large amounts of food or different foods).

See the instructions on page 30

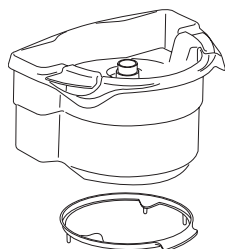

PASTA COOKER and COOKER SUPPORT

Support to be used with pasta cooker only.

Note: The round metal racks supplied are protected by a special chrome plating which allows them to be used safely in your microwave.

1.8 OVENWARE TO USE

In the "Microwave Only" and "Microwave Combined" modes, all types of containers in glass (preferably Pyrex), ceramics, china and clay may be used provided that they are undecorated and free of metal parts (i.e. gilt trimmings, handles, feet etc.). Heat resistant plastic containers can also be used, but only for "Microwave Only" cooking. If you are still doubtful about using a particular container, you can perform a simple test. Place the empty container in the oven for 30 seconds at maximum power ("Microwave Only" function).

If the container is still cold or only slightly warm, it is suitable for microwave cooking.

If it is very hot or gives out sparks, it is not suitable.

Paper napkins, cardboard trays and disposable plastic plates can also be used for short cooking times. The size and shape of the containers must be such as to allow them to rotate properly inside the oven.

Metal, wood, cane and crystal containers are not suitable for microwave cooking.

It is worth remembering that - since microwaves heat the food, not the dish - it is possible to cook the food directly on the plate on which it is to be served. This means that you do not need to use, and wash up, saucepans. However, remember that heat may be transferred from the food itself to the plate, making it necessary to use an oven glove.

If the oven has the "Fan Oven Only" or "Grill only" settings, all types of ovenware may be used.

In any case, observe the guidelines shown in the following table:

	Glass	Pyrex	Glass-ceramics	Clay	Silver foil	Plastic	Paper or cardboard	Metal containers
Mode: "Microwave Only"	YES	YES	YES	YES	NO	YES	YES	NO
Modes: "Combined"	NO	YES	YES	YES	NO	NO	NO	NO
Mode: "Fan Only" "Grill Only"	NO	YES	YES	YES	YES	NO	NO	YES

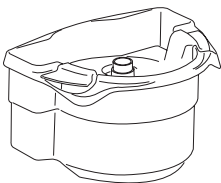

Important: Do not use this accessory with the "Grill Only", "Fan Only", "Combi Fan" or "Combi Grill" mode as the high temperatures could cause damage.

1.9 GENERAL RULES FOR MICROWAVE COOKING

Microwaves consist of electromagnetic radiation found in nature under the form of light waves (e.g., sunlight). Inside the oven, these waves penetrate food from all directions and heat up the water, fatty and sugar molecules.

Heat is produced very quickly only in the food itself, whereas the container being used warms up indirectly by means of heat given off by the heated food. This prevents food from sticking to its container, so you can use very little fatty substance or, in some cases, no fat at all during the cooking process.

Therefore cooking in a microwave oven is considered to be healthy and good for one's diet. And in contrast to traditional methods, cooking in a microwave foodstuffs are less dehydrated, lose less of their nutritional value, and retain more of their original flavour.

Basic rules for correct cooking with a microwave oven

- 1) In order to set cooking times correctly, remember (in referring to the charts on the following pages) that when you increase the amount of foodstuffs the cooking temperature must likewise be proportionately increased and vice-versa. It is important to respect the "standing" times: **standing time** means that period during which the food must be left to "rest" after being cooked so as to allow an even greater spreading of the temperature within. The temperature of meat, for example, will rise about 5°-8° C. (approx. 9°-15° F.) during the standing time. Standing times may be observed either inside or outside the oven.
- 2) One of the main things you must do is **stir** the food several times while it is being cooked. This helps make the temperature distribution more uniform and thus shortens the cooking time.
- 3) It is also advisable to **turn** the foodstuff **over** during its cooking process: this applies especially for meat, whether it is in large pieces (roasts, whole chickens, etc.) or small (chicken breasts, etc.).
- 4) **Foods having a skin, shell or peel (e.g., apples, potatoes, tomatoes, frankfurters, fish) must be pierced with a fork in several points so as to permit steam to escape and to prevent those items from exploding.**
- 5) If you are preparing a large number of portions of the same food item (e.g., boiled potatoes), **place** those portions in a Pyrex dish in order to have them cook in a uniform manner.
- 6) The lower the temperature at which a foodstuff is placed in a microwave oven, the longer the cooking time required. Food having a room temperature will cook more quickly than food having a refrigerator temperature.
- 7) Always do your cooking by placing the food container in the centre of the turntable.
- 8) It is perfectly normal for **condensation to form** inside the oven and near the air outlet. **To reduce such condensation, cover the foodstuffs with clear-sheet, wax paper, a glass lid or simply an overturned plate.** Foods having a water content (e.g., greens and vegetables) cook better when covered. The covering of food also helps keep the oven clean on the inside. Use clear-sheet made expressly for microwave ovens.
- 9) **Do not cook eggs in their shells:** the pressure which builds up on the inside would cause the egg to explode, even after cooking has finished. Do not heat up eggs which have already been cooked, unless they are scrambled.
- 10) Do not forget to open containers which are air-tight or sealed, before heating or cooking food in the oven. The pressure on the inside of the container would rise, causing them to explode even after cooking has finished.

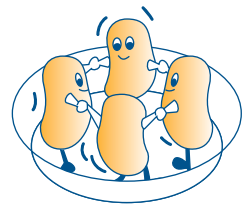
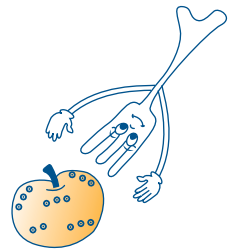

CHAPTER 2 – USING THE CONTROLS AND MODES

2.1 SETTING THE CLOCK (for key references see page 5)

- When the appliance is connected to the domestic power supply for the first time, or after a power cut, four dashes will appear on the display (----).
In order to set the clock, proceed as described below:

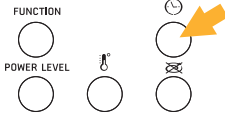

- 1** Press the  key (6).
(The hours flash on display 1)

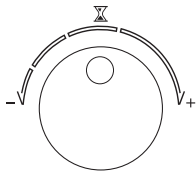
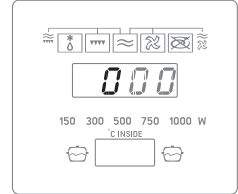

- 2** Set the desired time by turning the  knob (14).
(The hours flash on display 1)

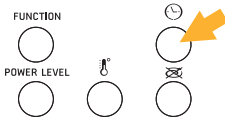
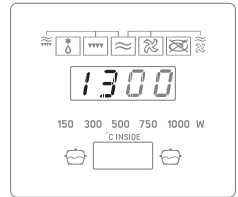

- 3** Press the  key (6) again.
(The minutes flash on display 1)

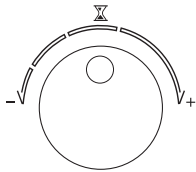

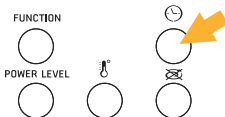

- 4** Set the desired minutes by turning the  knob (14).
(The minutes flash on display 1)



- 5** Press the  key (6) again.
(The display shows the time set)



- If you wish to change the hour on the dial once it has been set, press the  key (6) before proceeding to set the new time as described above.
- It is possible to display the current time even after starting the mode set, by pressing the  key (6) (the time is displayed for 2 seconds).

2.2 PROGRAMMING THE COOKING (for key references see page 5)

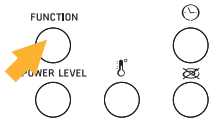

- 1** Press the **FUNCTION** key (3) (mode selection) and select the desired mode, which will be shown by the corresponding indicators coming on, on display 1. The available modes are:

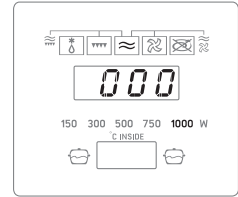

INDICATOR	MODE SELECTED
	Microwave Only
	Automatic Defrosting
	Combined Microwave and Fan Oven

INDICATOR	MODE SELECTED
	Combined Microwave and Grill
	Fan Oven Only
	Grill Only
	Countdown

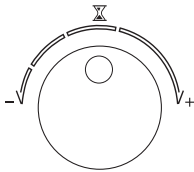

- 2** Set the length of cooking time, in minutes, by turning the knob (14). In order to choose the length of cooking time, always refer to the tables shown in Chapter 3.

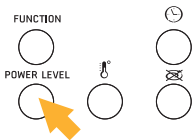
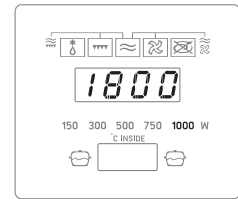

- 3** In the modes:
Microwave Only
Combined Microwave + Fan Oven
Combined Microwave + Grill

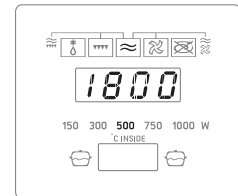

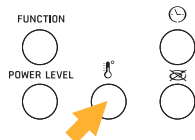

Select the power level of the microwave by repeatedly pressing the **POWER LEVEL** (5) key, until it begins to flash the power desired, expressed in numbers (Watt) above the display 2 (on the bottom). In order to select the power, always refer to the tables shown in Chapter 3.

- Note**
- it is not necessary to select any level of power for the **Automatic Defrosting mode**.
 - in the **Combined Microwave + Fan Oven** mode the maximum microwave power which can be selected is 750 Watts.
 - it is possible to modify the power set even during cooking, simply by pressing the **POWER LEVEL** key (5).

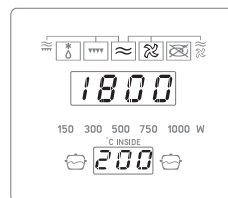

- 4** In the modes:
Combined microwave + fan oven
Fan oven only



Select the cooking temperature by repeatedly pressing the  key (4) until display 2 (below) shows the desired temperature. In order to select the temperature, always refer to the tables shown in Chapter 3.

- Note**
- once the cooking has started, display 2 will show the increase in real temperature inside the oven.
 - once the temperature set has been reached, a signal will be emitted (3 beeps). The temperature set will then remain shown on display 2.
 - it is possible to modify the power set during cooking, simply by pressing the  key (4).





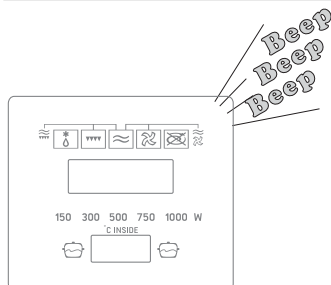

- 5** Start the cooking process by pressing the **START**  key (13). The count-down of the remaining cooking time will appear on the display 1, and if included in the mode, the oven temperature on the display 2.

Note: Should the cooking process for any reason fail to start, all the settings will be automatically cancelled after 2 minutes.



- 6** When cooking finishes, a signal is emitted (3 beeps) and the word "END" will appear on the display. Open the door and take out the food (the clock will appear, or if the oven is hot, the word "COOL" – see note below).

Note:

- It is possible to check the progress of the cooking at any time, by opening the door and inspecting the food. This interrupts the emission of microwaves and the oven stops working until the door is closed again and the  **START** key (13) is pressed.
- Should it be necessary for any reason to suspend the cooking without opening the door, you only need to press the  **STOP** key (12).
- In order to complete the cooking, proceed as follows:
 - if the oven door is open, press the  **STOP** key (12) once;
 - if the door is closed and cooking is underway, press the  **STOP** key (12) twice; the display will go back to showing the clock.
- this model is equipped with an automatic cooling cycle which comes into action whenever the oven is very hot (for example after something has been cooked for a long time). During this cycle the word "COOL" will appear on display 1. The fans and the oven light will come on (they will go off automatically).

While the word "COOL" is displayed, the oven will accept each commands except the "Pasta" keys.

At the end of each cooking cycle, the oven light and the cooling fan will remain in operation until the oven door is opened.

2.3 AUTOMATIC DEFROSTING AND COOKING SEQUENCE (for key references see page 5)

In order to programme an automatic defrosting and cooking sequence proceed as follows:

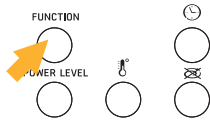

- 1** Set the automatic defrosting mode by pressing the **FUNCTION** key (3) twice (mode selection). The indicator corresponding to the automatic defrosting will appear on the display.

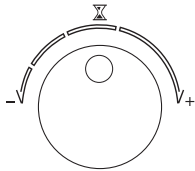
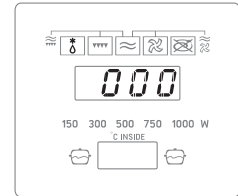

- 2** Set the length of time required for the defrosting (in minutes) by turning the Σ knob (14).

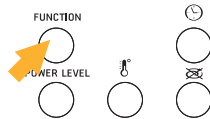
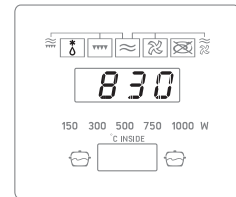

- 3** Set the cooking by selecting the desired mode with the **FUNCTION** key (3) (mode selection) until the corresponding indicators appear. (ex. Combined microwave + fan function)

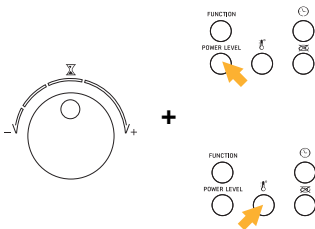
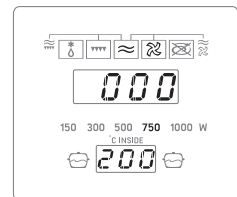

- 4** Adjust the length of cooking time and, if included in the mode, the microwave power level and the oven temperature as shown in the preceding paragraph (par. 2.2).

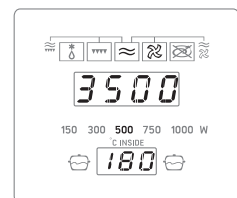

- 5** Press the \diamond **START** key (13). The passage from defrosting to cooking will be signalled by a signal.

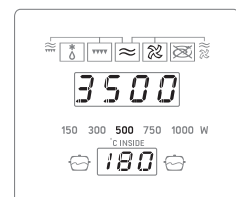
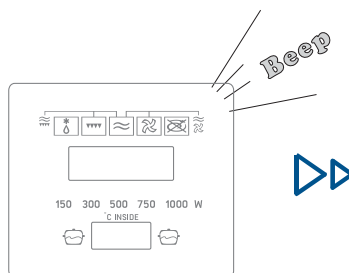
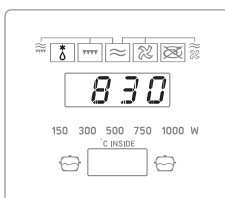

2.4 RECALLING THE PRE-MEMORISED RECIPES ("AUTOMATIC FUNCTIONS" KEYS) (for key references see page 5)



- 1 Press the desired "**Automatic Functions**" key.
(The indicators of the length and temperature set will flash on the display and the pre-memorised mode and power level indicators will come on.)
Refer to paragraph 4.8 in order to choose the most suitable menu.



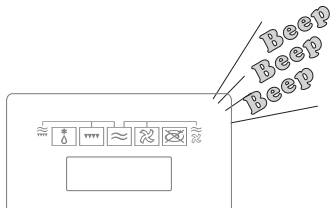

- 2 Press the  **START** key (13) in order to start cooking.



- 3 At the end of the time set 3 long beeps will be heard and the word "**END**" will appear on the display.

2.5 QUICK REHEAT

This mode is very useful for heating small quantities of food or drink.



- Press the  **START** key (13); the oven will come on for 30 seconds at full power. By pressing the  **START** key again the time will extend by 30 seconds intervals, up to 3 minutes.
 - This mode is activated only if it is carried out within 1 minute after the food has been placed in the oven.
- The Quick Reheat is also useful to complete unfinished cooking.

Once the cooking procedure has begun, the programmed time can be modified with the  (14) knob to a maximum time limit of 60 minutes.

2.6 CHILD LOCK-OUT FEATURE

The oven is equipped with a safety device which prevents pre-set cooking times from being tampered with while the cooking is underway, in order to avoid accidental and dangerous extensions to the cooking time which might cause the food to burn.

To activate the safety device:

- Keep the  **STOP** key (12) pressed down for 5 seconds.
- A short beep is emitted: from this point it will no longer be possible to alter the times during all cooking.
- In order to deactivate the safety device once it has been previously activated, keep the  **STOP** key (12) pressed until the beep is heard.



2.7 TURNTABLE STOP KEY

When using large sized containers/recipient (or containers with handles) that are not able to rotate, the movement of the turntable can be stopped. Press the  **TURNTABLE STOPPER** key (15), after having first set a cooking function: the LED in the top right will start flashing.

After having pressed  **START**, the LED will flash a further 5 times, and will then remain on for the entire set time; for best results, the food should be mixed/stirred a number of times during cooking. The **TURNTABLE STOPPER** function will remain on when the oven is used again, that is until the **TURNTABLE STOPPER** key is pressed again. For the microwave-only function, the maximum power available is 750W (reduced automatically by the electronic controller when pressing the **TURNTABLE STOPPER** key).

2.8 "MEMOTIME" FUNCTION

This function allows for the use of the timer, with the oven **NOT** functioning, for up to 60 minutes.

- Press the **FUNCTION** key until 3 dashes appear on display 2, then select the time desired by turning the  (14) knob and start the timer by pressing the  **START** (13) key.
- At the end, 3 beeps will sound and the "end" warning will appear on display 1.

CHAPTER 3 - USING THE PASTA COOKER

Pasta cooking using the exclusive accessory Pasta with this oven has been analysed by sensory and chemical tests at the University of Bologna, Italy, as confirmed by the accompanying certificate:

PRELIMINARY RESULTS OF ONGOING COLLABORATION WITH UNIVERSITY OF BOLOGNA (SITE OF CESENA)

Introduction

Object of the agreement was the comparative evaluation of pasta quality submitted to traditional cooking (in boiling water) and cooked using the microwave equipment (Patent MI2001A002147).

Description of tested technology

During the experimental study, a microwave (MW) oven, suitable for domestic use, equipped with an originally designed and patented container, was used to cook spaghetti samples.

The quality parameters of MW cooked pasta have been compared, using strictly standardised procedures, with similar pasta samples obtained from traditional cooking cycles in boiling water, following the directions suggested by the pasta producer.

Having thoroughly tested the innovative MW equipment, subjected to critical evaluation in the present study, it was possible to automatically cook pasta just by placing a well defined amount of uncooked dry pasta in the container supplied with the oven, adding the right quantity of water (tap water or pre-heated water), and starting the oven.

Methodology

Analytical methodologies have been used to evaluate some characteristic aspects of cooked pasta as absolute values through a comparison between MW oven cooked pasta and traditional cooked pasta, following cooking directions generally used in both domestic and industrial cooking in catering service.

Analytical controls

Analytical evaluations were carried out in laboratory about the behaviour of pasta during cooking (water increase, weight increase, release of starch), instrumental test of pasta rheology and quality (superficial stickiness, firmness, colour, volume increase, etc.), and sensorial evaluation by a trained panel test.

Furthermore, structures of samples from both MW and traditionally cooked pasta were examined by scanning electronic microscopy (SEM).

Most of the methodologies have been chosen on the basis of national and international literature on pasta quality evaluation.

To perform the comparative study was used the same batch of pasta coming from the largest pasta manufacturer in Italy.

Results

On the basis of the performed research, it has been shown that the two methods of cooking are statistically equivalent for quality parameters, i.e. water absorption, weight increase, stickiness, firmness, colour and volume increase during cooking. The rate of release of organic material (mainly starch) from the pasta sample into the cooking water and the rate of gelatinisation of starch in the samples, resulted significantly ($p < 0.05$) lower for MW cooked samples. These results could mean a higher level of retention of original starch in the pasta structure.

This could be explained by the temperature profile of the cooking cycle that, in MW cooking, reaches the boiling point of water only at the end of the cooking time.

Sensorial analysis by panel test showed that the two samples (MW and traditional cooked pasta) are not significantly different taking into account most of the sensory descriptors, such as firmness, superficial stickiness, sauce adhesion, etc.

Judgement on MW pasta cooking apparatus

The obtained results allow to confirm that the use of the innovative MW pasta cooking equipment, by following manufacture directions, is suitable to cook a good quality pasta in a domestic environment.

In witness whereof

Prof. Marco Dalla Rosa

*Visiting Professor of Food Technology Processes
Food Sciences and Technologies, University of Bologna.*



3.1 - INTRODUCTION

The pasta cooker accessory can be used to cook all types of pasta, maintaining its nutritional value. This new and exclusive system reduces cooking time and simplifies preparation, avoiding the need to add the pasta once the water has come to the boil, mix it during cooking or raise the cover to avoid the foam boiling over.

Before using for the first time, wash all pasta cooker accessories with water and washing up liquid or in a dishwasher.

3.2 - USING THE COOKER AND SETTING THE CONTROLS

- 1 Remove the turntable (H) and turntable support with wheels (I) from the oven.

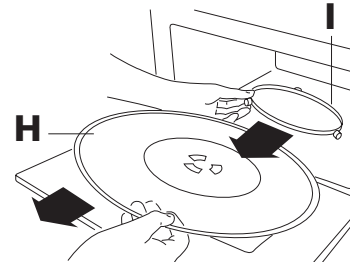

- 2 Position the pasta cooker support as shown in the figure, inserting the three pins into the three holes in the bottom of the cavity (the word PASTA should face the front).

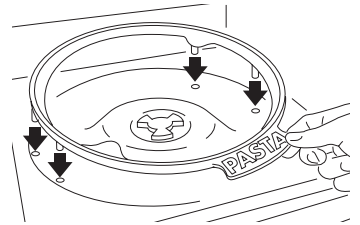

- 3 Insert the shaft into the hole in the bottom of the container. To lock the shaft, push upwards and rotate until the two teeth protrude from the slots (this can be facilitated by looking from the inside of the container). Insert the mixer into the central housing, making sure the blades are in contact with the bottom and not raised excessively.

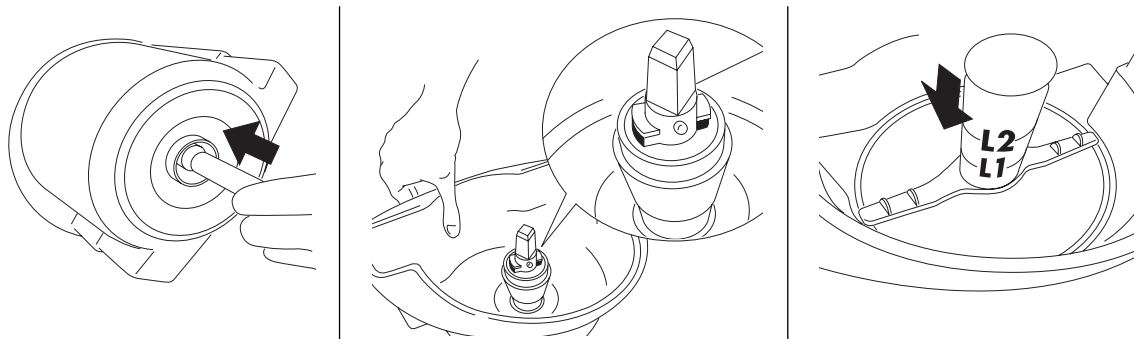

- 4 Add the pasta to the container (max. 400 g), taking care not to exceed the L2 level on the mixer. Whole spaghetti must be positioned in the special compartment illustrated in the figure. Make sure the spaghetti are not raised.

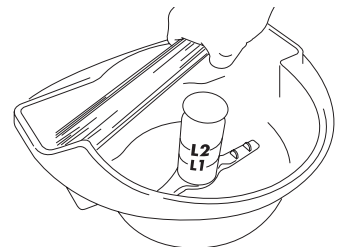

- 5** Level the pasta by shaking the container gently. Pour in the water (*) required to cover the pasta completely **until it reaches one of the two levels (L1 or L2)** on the mixer as shown in the pictures below:

RIGHT:

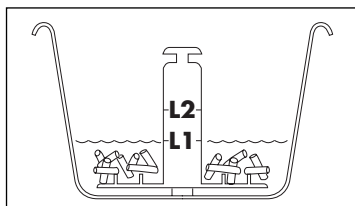
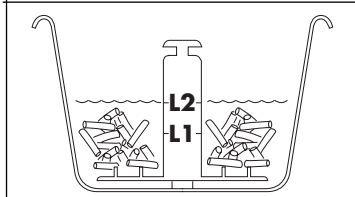
	<p>The pasta is completely covered by the water at the L1 level (min).</p>
	<p>The pasta is completely covered by the water at the L2 level (max).</p>

WRONG:

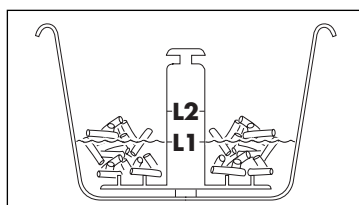
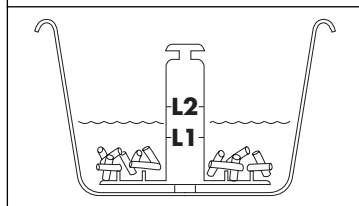
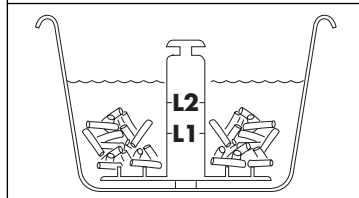
	<p>The pasta is not properly covered by the water.</p>
	<p>Water level is between L1 and L2 (it must be either L1 or L2 level)</p>
	<p>The level of water exceeds the maximum amount of water allowed for the PASTA function (over the L2 level)</p>

Remember that the level of water must **ALWAYS** reach either Level L1 or Level L2 and must never be between the two.

IMPORTANT:

- **REMEMBER TO PUT IN THE PASTA FIRST AND THEN THE WATER.**
- **THE PASTA MUST BE COMPLETELY COVERED BY THE WATER OR PASTA EMERGING FROM THE WATER COULD BE OVERCOOKED AND ASSUME A BURNT COLOUR.**

Remember that pasta increases considerably in volume during cooking. If level 1 provides only minimal coverage of the pasta (eg. pasta with high volume formats), you are recommended to increase the water to L2.

(*) *The water may be either at room temperature (about 20°C) or hot (about 50°C).
The hotter the water, the shorter the cooking time.*

- 6** Add salt (10 g. salt for each liter of water) and cover the container with the cover. Make sure the hatch is free to open. Place inside the oven, making sure the handles are facing the door as shown in the figure. The container must be positioned on the pasta cooker mount inserted previously (see point 2); the word PASTA will appear on the display. Close the door.

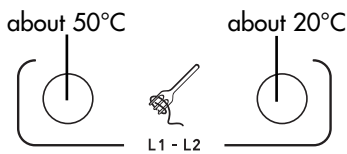
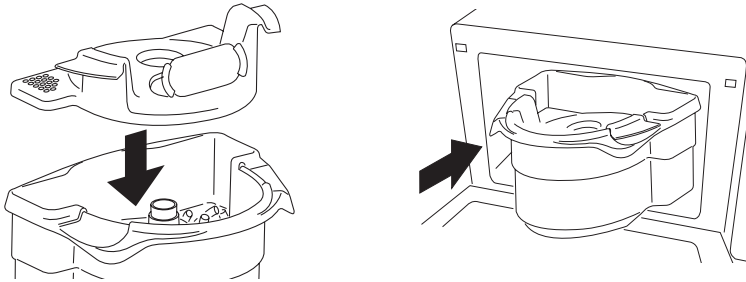

- 7** Select the key corresponding to the water temperature - red if the water you have added is hot (about 50°C) or blue for water at room temperature (about 20°C). Set the level of water in the container (L1 or L2) by pressing the same key a number of times.

The lower display will show the corresponding key selected (hot water or cold water)

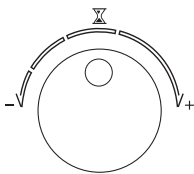
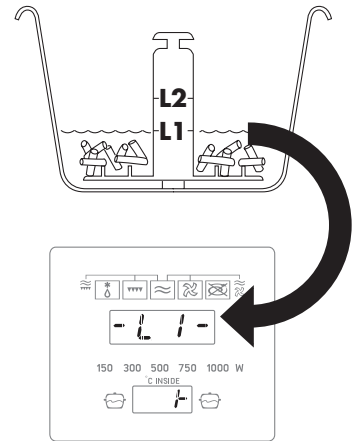

- 8** Select the cooking time written on the pack for the pasta used (eg. 8 minutes) by rotating the  knob (14).

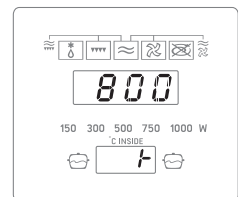



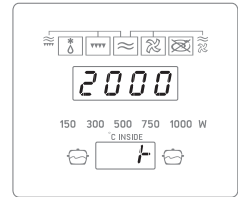

9 Press the  **START** key (13) to start cooking.





The oven will automatically calculate the TOTAL time required to heat the water and complete cooking. This will be immediately displayed.

At the start of cooking, the mixer is stationary. It begins rotating automatically about halfway through cooking.

One minute from the end, the oven will emit a "beep". This indicates that the time is nearly over and you are recommended to remove the container and taste the pasta (through door). Pay attention to the escaping steam.

If the pasta is already cooked, press the  **STOP** key (12) to interrupt the remaining cooking programme. If the pasta is still hard, finish cooking for the remaining minute by pressing the  **START** key (13).

At the end of the minute, the oven will emit three beeps and the word "END" will be displayed. You can then remove the container to drain the pasta or check whether it is cooked again:

If the pasta is already cooked, press the  **STOP** key (12), drain the pasta keeping the handles firmly pressed and sloping the container forwards and leftwards to allow the water to drain out of the holes on the left side of the cover (see figure alongside). Remove the cover, lifting it by the handles (take care to avoid escaping steam), remove the mixer, pour out the pasta and add the sauce. If the pasta is still not cooked to your taste, the cooking time can be prolonged by replacing the container, closing the door ("000" will flash on the display) and setting additional minutes by rotating the  knob (14) and pressing the  **START** key (13).

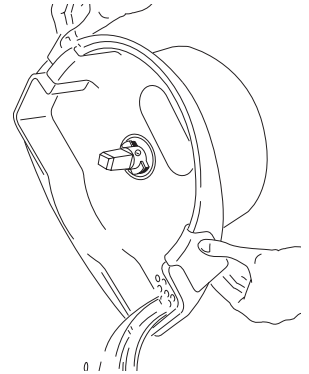

3.3 - IMPORTANT WARNINGS

When using the pasta cooker accessory, pay attention to the following:

- Take care when removing the container from the oven and draining the pasta. the plastic may seem cold, but escaping steam could cause burns. **You are recommended to use oven gloves.**
- Never place the accessory above sources of heat or the oven when in operation.
- Do not cook pasta immediately after using the oven in combi or grill mode. The temperature of the oven could be too high, thus damaging the container.

While the word "COOL" is displayed, the oven will accept each commands except the "Pasta" keys.

- Make sure the hatch in the cover is always clean and free to open.
- The pasta cooker must be used to cook pasta according to the instructions in this book. It must never be used for other purposes.
- Never use the pasta cooker empty without water and pasta.
- While the pasta cooker is in the oven, other modes cannot be set.

To clean the accessory, see page 57.

CHAPTER 4 – USING THE OVEN: SUGGESTIONS AND COOK CHARTS

4.1 DEFROSTING

- Frozen food in plastic bags, plastic film or cardboard packets can be placed directly in the oven for defrosting as long as the packet has no metal parts (e.g. metal twist ties or staples).
- Certain foods, such as vegetables and fish, do not require complete defrosting before cooking.
- Boiled foods, stews and meat sauces defrost better and more quickly if they are stirred from time to time, turned over and/or separated.
- Meat, fish and fruit lose a certain amount of liquid during defrosting. Defrost these foods in a bowl.
- It is advisable to separate each individual piece of meat into its own bag before putting it into the freezer. This will enable you to save precious preparation time.
- It is important to observe the standing times immediately after defrosting, before cooking; the standing time (in minutes) is the length of time for which the food must be left to stand to allow the heat to continue spreading evenly in the food.

TABLE OF DEFROSTING TIMES IN “AUTOMATIC DEFROSTING” MODE

TYPE	QUANTITY	TIME (minutes)	NOTES/SUGGESTIONS	WIRE RACK TO BE USED	STANDING TIME
MEAT					
• Roasts (pork, beef, veal etc.)	1 kg	19 - 21	Turn over halfway through defrosting	None	20
• Steaks, chops, rashers	200 gr	4 - 6		None	5
• Stew, goulash	500 gr	10 - 12	See note *	None	10
• Minced	250 gr	5 - 7		None	15
	500 gr	10 - 12		None	15
• Hamburgers	200 gr	5 - 7		None	10
• Sausages	300 gr	6 - 8		None	10
POULTRY					
• Duck, turkey	1,5 kg	25 - 27	Turn the poultry over halfway through defrosting. When the standing time is over, wash under warm water to remove any ice.	None	20
• Whole chicken	1,5 kg	25 - 27		None	20
• Pieces of chicken	700 gr	13 - 15		None	10
• Chicken breast	300 gr	8 - 10		None	10
VEGETABLES					
			Frozen vegetables do not need to be defrosted before cooking.		
FISH					
• Fillets	300 gr	7 - 9	Turn the fish over halfway through defrosting	None	7
• Slices	400 gr	8 - 10		None	7
• Whole	500 gr	10 - 12		None	7
• Prawns	400 gr	8 - 10		None	7
MILK/DAIRY PRODUCTS					
• Butter	250 gr	4 - 6	Remove the silver foil or the metal parts. Cheese should not be completely defrosted. Respect the standing time. The cream should be removed from its container and placed in a dish.	None	10
• Cheese	250 gr	5 - 7		None	15
• Cream	200 ml	7 - 9		None	5
BREAD					
• 2 medium-sized rolls	150 gr	1 - 2	Put the bread directly onto the turntable.	None	3
• 4 medium-sized rolls	300 gr	2 - 4		None	3
• Sliced bread	250 gr	2 - 4		None	3
• Sliced wholemeal bread	250 gr	2 - 4		None	3
FRUIT					
• Strawberries, plums, cherries, redcurrants, apricots	500 gr	8 - 10	Stir 2-3 times	None	10
• Raspberries	300 gr	5 - 7	Stir 2-3 times	None	10
• Blackberries	250 gr	3 - 5	Stir 2-3 times	None	6

* These indications are suitable for performing the minced meat defrosting test according to Regulation 60705, Par. 13.3 (see page 2). Turn over halfway through the set time. Place directly on the turntable.

Further information, including on other performance tests according to Regulation 60705, is given in the table on page 2.

4.2 REHEATING

Reheating food is one of the modes in which your microwave oven displays all its usefulness and efficiency. Compared to traditional methods, using a microwave obviously saves time and therefore electricity.

- It is advisable to reheat food (especially if it is frozen) to a temperature of at least 70°C (it must be piping hot). This means the food will not be ready to eat immediately because it is too hot!) but it will be completely sterilised.
- In order to reheat pre-cooked or frozen food, always observe the following rules:
 - always remove the food from metal containers
 - cover it with transparent film (of the kind suitable for microwave ovens) or grease proof paper so that all the natural flavour is preserved and the oven will stay cleaner; the food may also be covered with an upturned plate;
 - if possible, stir or turn the food frequently in order to speed up the reheating process and to make it cook more evenly;
 - follow the cooking times shown on the packet with considerable caution; remember that, under certain conditions, the times shown must be increased.
- Frozen food must be defrosted before being reheated. The lower the initial temperature of the food, the longer the reheating time will have to be.

Note: some dishes can also easily be reheated by using the "Automatic Functions" pre-memorised recipes (see table on page 54).







TABLE OF REHEATING TIMES

TYPE	QUANTITY	FUNCTION	POWER LEVEL	TIME minutes	NOTES/SUGGESTIONS
SOFTENING AND MELTING FOOD					
• Chocolate/icing	100 gr	☞	500	4 - 5	Put in a dish. Mix the icing once. To melt butter, add one minute.
• Butter	50-70 gr	"	1000	0'.10"-0'.15"	
CHILLED FOODS (5/8°C) up to 20/30°C					
• Yoghurt	125 gr	"	1000	0'.15"-0'.20"	Remove the metal top. Heat the baby's bottle without the teat and mix it immediately after heating to make the temperature uniform. Check the temperature of the contents before use. With milk at room temperature the heating time is lower. To avoid risk of fire when using dried milk please stir evenly. Please use already sterilized milk.
• Feeding bottle	240 gr	"	"	0'.30"-0'.35"	
PRE-COOKED CHILLED FOODS (initial temp. 5/8°C) up to approx. 70°C					
• Packet of lasagne or stuffed pasta	400 gr	"	1000	3 - 5	Packets of any type of pre-cooked food available in the shops, to be reheated to 70°C. Remove the food from any metal container and put it directly onto the plate from which it is to be eaten. For best results the food should always be covered.
• Packet of meat with rice and/or vegetables	400 gr	"	"	3 - 5	
• Packet of fish and/or vegetables	300 gr	"	"	2 - 4	Plate of meat and/or vegetables Portions of any type of cooked food to be reheated to 70°C. The food should be placed directly onto the plate from which it is to be eaten and should always be covered either with transparent film or with an upturned plate.
• Plate of meat and/or vegetables	400 gr	"	"	4 - 6	
• Plate of pasta, cannelloni or lasagne	400 gr	"	"	4 - 6	
• Plate of fish and/or rice	300 gr	"	"	3 - 5	
FROZEN FOOD TO BE REHEATED/COOKED (initial temp. -18/-20°C) up to approx. 70°C					
• Packet of lasagne or stuffed pasta	400 gr	"	1000	5 - 7	All kinds of pre-cooked frozen food to be reheated to 70°C directly in the packet. For metal containers, place the food directly onto the dish from which it is to be eaten and increase the cooking time by a few minutes.
• Packet of meat with rice and/or vegetables	400 gr	"	"	4 - 6	
• Packet of pre-cooked fish and/or vegetables	300 gr	"	"	2 - 4	Remove raw food from the packets, place it in a container suitable for microwaves and cover. Portions of cooked frozen food to be heated to 70°C. Place the frozen food onto the dish from which it is to be eaten and cover it with an upturned plate or Pyrex lid. Make sure that it is thoroughly heated in the centre; if possible, stir the food.
• Packet of fish and/or raw vegetables	300 gr	"	"	6 - 8	
• Portion of meat and/or vegetables	400 gr	"	"	5 - 7	
• Portion of pasta, cannelloni or lasagne	400 gr	"	"	6 - 8	
• Portion of fish and/or rice	300 gr	"	"	3 - 5	
CHILLED DRINKS (5/8°C) up to approx. 70°C					
• 1 cup of water	180 cc	"	1000	1'.30" - 2'	All drinks should be shaken after reheating to spread the temperature evenly. We recommend covering clear soup with an upturned plate.
• 1 cup of milk	150 cc	"	"	1'.15" - 1'.45"	
• 1 cup of coffee	100 cc	"	"	1'.15" - 1'.45"	
• 1 bowl of clear soup	300 cc	"	"	3 - 4	
DRINKS AT ROOM TEMPERATURE From 20/30°C up to approx. 70°C					
• 1 cup of water	180 cc	"	1000	1'.15" - 1'.45"	All drinks should be shaken after reheating to spread the temperature evenly. We recommend covering clear soup with an upturned plate.
• 1 cup of milk	150 cc	"	"	1 - 1'.30"	
• 1 cup of coffee	100 cc	"	"	0'.45" - 1'.15"	
• 1 bowl of clear soup	300 cc	"	"	2 - 3	

4.3 - COOKING STARTERS, PASTA AND ENTREES

















Vegetable soups and other soups in general require less liquid because in a microwave oven evaporation is rather minimal. Salt must be added only at the end of cooking or during standing time as it dehydrates the food.

It is fair to say that the time needed to cook rice in the microwave oven (as indeed for pasta) is more or less equal to that needed to cook it on a stove in the traditional manner. The advantage of preparing a risotto in a microwave oven is that it does not need stirring continually (this only needs to be done 2 or 3 times).

TYPE	QUANTITY	FUNCTION	POWER LEVEL	TEMPERATURE	TIME minutes	NOTES/SUGGESTIONS	WIRE RACK TO USE
• Lasagne	1100 gr		1000 1000	- -	8 + 8	Suitable times for uncooked pasta. If the pasta is pre-cooked, 8 minutes of Combined MICROGRILL cooking is enough.	Low
• Gnocchi alla romana	600 gr		1000	-	12	Avoid piling them up too heavily	Low
• Macaroni	1500 gr		1000	-	8	The pasta should have previously been boiled separately.	Low
• Risotto	300 gr. of rice		1000	-	12-15	The ingredients should all be placed together in a container suitable for microwaves and covered with transparent film (750 g of clear soup is needed for 300 g of rice with the microwaves on full power for approx. 10-12 minutes). Spread the pizza on oven paper resting on a shelf for cakes or on the detachable base of metal baking sheet for cakes. Preheat the oven to 200°C.	None
• Pizza	800 gr		-	200°C	30	Use a cake tin with a handle (the oven should be pre-heated).	Low
• Fresh Quiche Lorraine	800 gr		-	160°C	40	Place on the bottom of a metal baking sheet (the oven should be pre-heated).	Low
• Frozen Quiche Lorraine	550 gr		-	190°	45		Low

4.4 - COOKING MEAT

Cooking is closely linked to the size and uniformity of the food which is to be cooked: kebabs cook faster than a roast because they consist of smaller, more evenly-sized pieces of meat. To keep roasts, chicken and kebabs moist, it is advisable to add 1 or 2 cups of water at the start of cooking.

TYPE	QUANTITY	FUNCTION	POWER LEVEL	TEMPERATURE	TIME minuti	NOTES/SUGGESTIONS	WIRE RACK TO USE
• Roasts (pork, beef)	1000 gr	 	500	190°C	35-40	Leave on a little fat to avoid it drying out. Do not add much sauce.	Low
• Meatloaf	800 gr	 	500	180°C	22-25	Mix 500 g of minced beef with egg, ham, Bread crumbs, etc. Add a touch of oil and a little white wine.	Low
• Meatloaf	900 gr		750	-	20	See note *	None
• Whole chicken	1200 gr	 	750	190°C	40	Prick the skin to allow the fat to run off. See note **	Low
• Pieces of chicken	850 gr	 	750	190°C	25	Stir once during cooking	Low
• Kebabs	600 gr	 	500	180°C	17-20	Turn halfway through cooking	Low
• Goulash	1500 gr		1000	-	30-35	Cook uncovered and stir 2-3 times	None
• Chicken breast	500 gr		700	-	10-15	Turn halfway through cooking	None
• Veal or pork chop	3 pieces		-	-	16-18	Preheat the oven for 3 minutes. Turn through cooking, as the heating element only irradiates heat from the upper part of the oven.	High
• Sausages	3 pieces		-	-	10-12	Preheat the oven for 3 minutes. Turn through cooking, as the heating element only irradiates heat from the upper part of the oven.	High
• Hamburgers	3 pieces		-	-	10-12	Preheat the oven for 3 minutes. Turn through cooking, as the heating element only irradiates heat from the upper part of the oven.	High

* These indications are suitable for performing the minced meat cooking test according to Regulation 60705, Para. 12.3.3. Cover the container with clear film for microwave use. Further information, including on other performance tests according to Regulation 60705, is given in the table on page 2.

** These indications are suitable for performing the cooking test according to Regulation 60705, Para. 12.3.6. Further information, including on other performance tests according to Regulation 60705, is given in the table on page 2.

4.5 - COOKING SIDE DISHES AND VEGETABLES

Vegetables cooked in a microwave oven preserve their colour and nutritional value better than in traditional cooking.

Wash and peel the vegetables before starting to cook.

Larger vegetables should be cut into evenly-sized pieces.

Add approx. 5 spoonfuls of water for every 500g of vegetables (vegetables which have a high fibre content require more water).

The vegetables should always be covered with transparent film.

Stir at least once halfway through cooking and add a little salt only at the end.

Warning: the cooking times in the table are purely intended as guidelines and are on the basis of the food's weight and initial temperature as well as its texture and structure.

TYPE	QUANTITY	FUNCTION	POWER LEVEL	TEMPERATURE	TIME minutes	NOTES/SUGGESTIONS	WIRE RACK TO USE
• Asparagus	500 gr	≈	1000	-	8-9	Cut into 2 cm pieces	None
• Artichokes	300 gr	≈	1000	-	10-11	It would be better to use artichoke bottoms	None
• Green beans	500 gr	≈	1000	-	10-11	Cut in pieces	None
• Broccoli	500 gr	≈	1000	-	6-7	Separate into single "florets"	None
• Brussels sprouts	500 gr	≈	1000	-	6-7	Leave whole	None
• White cabbage	500 gr	≈	1000	-	6-7	Leave whole	None
• Red cabbage	500 gr	≈	1000	-	6-7	Leave whole	None
• Carrots	500 gr	≈	1000	-	8-9	Cut into evenly-sized pieces	None
• Cauliflower	500 gr	≈	1000	-	10-11	Separate into "florets"	None
• Cauliflower in béchamel sauce	1000 gr	≈ + ▼▼▼	1000	-	7 + 10	Same cooking time as for raw cauliflower. If pre-cooked, needs only 10 minutes with grill in Combined mode	Low
• Celery	500 gr	≈	1000	-	6-7	Separate into pieces	None
• Aubergines	800 gr	≈	1000	-	5-6	Cut into cubes	None
• Grilled aubergines	4 slices	▼▼▼	-	-	9-11	Preheat for 3 minutes. Turn halfway through cooking	High
• Aubergines "parmigiana"	1300 gr	≈ ▼▼▼	1000	-	7-9	The aubergines may be first grilled or fried	Low
• Leeks	500 gr	≈	1000	-	5-6	Leave whole	None
• Button mushrooms	500 gr	≈	1000	-	5-6	Leave whole and cover. No need for water	None
• Onions	250 gr	≈	1000	-	4-5	Whole if even-sized. No need for water	None
• Spinach	300 gr	≈	1000	-	5-6	Cover after washing and draining	None
• Peas	500 gr	≈	1000	-	9-10		None
• Fennel	500 gr	≈	1000	-	11-12	Cut into quarters	None
• Grated tomatoes	800 gr	≈ ▼▼▼	500	-	9-11	It is preferable for them to be even-sized	Low
• Peppers	500 gr	≈	1000	-	8-9	Cut into pieces	None
• Grilled peppers	4 quarters	▼▼▼	-	-	9-11	Preheat for 3 minutes. Turn halfway through cooking	High
• Stuffed peppers	1400 gr	≈ + ≈ ▼▼▼	1000 1000	- -	8 + 9	Preferably the short, broad kind	Low
• Potatoes	500 gr	≈	1000	-	7-8	Cut into evenly-sized pieces	None
• Roast potatoes (fresh)	500 gr	≈ ☞	500	190°C	25-30	Stir 2-3 times	Low
• Roast potatoes (frozen)	900 gr	≈ ☞	500	200°C	35-40	Stir 2-3 times	Low
• Potato gratin	1100 (total) gr	≈ ☞	750	190°C	20	See note *	Low
• Courgettes	500 gr	≈	1000	-	6-7	Leave whole	None

*These indications are suitable for performing the cooking test according to Regulation 60705, Para. 12.3.4. Further information, including on other performance tests according to Regulation 60705, is given in the table on page 2.

4.6 - COOKING FISH

Fish cooks very quickly and with excellent results. It can be dressed with a little butter or oil (or even left without). Cover it with transparent film. Naturally if it has its skin, this must be scored or cut; the fillets should be arranged evenly. It is not advisable to cook fish breaded with egg.

TYPE	QUANTITY	FUNCTION	POWER LEVEL	TEMPERATURE	TIME minutes	NOTES/SUGGESTIONS	WIRE RACK TO BE USED
• Fillets	300 gr	≈	750	-	5-7	Cover with film	None
• Pieces	300 gr	≈	750	-	7-9	Cover with film	None
• Whole	500 gr	≈	750	-	8-10	Cover with film	None
• Whole	250 gr	≈	750	-	5-7	Cover with film	None
• Slices	400 gr	≈	750	-	7-9	Cover with film	None
• Prawns	500 gr	≈	750	-	7-9	Cover with film	None
• Oven cooked	600 gr	≈ ☼	150	190°	30	Add oil, a clove of garlic and drop of white wine and water. Do not cover.	Low

4.7 - COOKING DESSERTS AND CAKES



For cooking all cakes the oven must be preheated to the temperature shown in the table. Only after reaching the temperature set (signalled by 5 beeps) may the cake be placed in the oven

TYPE	QUANTITY	FUNCTION	POWER LEVEL	TEMPERATURE	TIME minutes	NOTES/SUGGESTIONS	WIRE RACK TO BE USED
• Hazelnut cake	1100 gr	≈ ☼	150	170°C	25-30	Use a heat-resistant container	Low
• Cheese cake	1500 gr	≈ ☼	500	160°C	35-40	Use a heat-resistant container	Low
• Jam tart	700 gr	☼	-	160°C	40	Use a metal cake tin	Low
• Plum cake	950 gr	☼	-	160°C	90	Use a rectangular mould	Low
• Light sponge cake	700 gr	☼	-	160°C	40	Use a metal cake tin	Low
• Walnut cake	650 gr	☼	-	160°C	40	Use a metal cake tin	Low
• Egg custard	750 gr	≈	1000	-	16	See note *	None
• Sponge cake	475 gr	≈	1000	-	6	See note **	Low
• Cake	710 gr	≈ ☼	150	160°C	30	See note ***	Low

- * These indications are suitable for performing the cooking tests according to Regulation 60705, Para. 12.3.1. Further information, including on other performance tests according to Regulation 60705, is given in the table on page 2.
- ** These indications are suitable for performing the cooking tests according to Regulation 60705, Para. 12.3.2. Further information, including on other performance tests according to Regulation 60705, is given in the table on page 2.
- *** These indications are suitable for performing the cooking tests according to Regulation 60705, Para. 12.3.5. Remember to preheat the oven in fan only mode with the low wire rack in place. Further information, including on other performance tests according to Regulation 60705, is given in the table on page 2.

4.8 - REHEATING/COOKING USING THE "AUTOMATIC FUNCTIONS" KEYS

The "Automatic Functions" keys are 3 different programmes with "pre-memorised" length of cooking time, power level and oven temperature; they afford excellent results for the dishes described in the following table.

KEY	WHAT TO DO	SUGGESTIONS
(7)  <ul style="list-style-type: none"> • Press once • Press twice • Press 3 times • Press 4 times 	<ul style="list-style-type: none"> • Reheat 1 small coffee cup (50 cc) at room temperature. • Reheat 1 coffee cup (125 cc) starting from room temperature. • Reheat one large cup (200 cc) starting from chilled • Reheat 1 soup dish (300 cc) starting from chilled 	<p>After reheating the liquid, stir well to spread the temperature evenly.</p>
(8)  <ul style="list-style-type: none"> • Press once • Press twice 	<p>Warning: at the end of the reheating the food and the containers may be very hot. Use tweezers or oven gloves.</p> <ul style="list-style-type: none"> • Reheat 1 portion (250-350 g) • Reheat 2 portions (450-550 g) 	<p>Suitable for cooked portions of food, stored in the refrigerator on the plate (the one from which the food is to be eaten). In the case of pre-cooked food products, remove the food from any aluminium packaging/containers and place it on an ovenproof plate.</p>
(9)  <ul style="list-style-type: none"> • Press once • Press twice • Press 3 times 	<p>Warning: at the end of the reheating the food and the containers may be very hot. Use tweezers or oven gloves.</p> <ul style="list-style-type: none"> • Reheat 1 frozen pizza (250-500 g) • Reheat 1 portion (250-350 g) • Reheat 2 portions (450-550 g) 	<p>Place the pizza directly on the low wire rack.</p> <p>Place the packet on the turntable, being careful to remove any covers (film, bags). If the packet is not suitable for microwaves, however, (e.g. metal pans), remove the food from the packet on to the serving dish, placing it uncovered on the turntable.</p>

4.9 - SIMULTANEOUS COOKING ON 2 LEVELS

By using the spacer wire rack at medium height with the microwave-only function, you can defrost, reheat and cook foods at the same time, even different dishes on two levels. The special double-microwave-emission system makes possible, in fact, a perfect distribution of energy.

When you wish to cook two food dishes at the same time, all you have to do is keep these basic rules in mind:

- 1) The cooking times for food dishes cooked at the same time are different from those for the cooking of single dishes. So always consult the reference table on page 56.

<i>Times for simultaneous cooking</i>	
Potatoes (above)	16 min
Goulash (below)	40 min

<i>Cooking times for single dishes</i>	
Potatoes	7 - 8 min
Goulash	30 - 35 min

- 2) Be careful to ALWAYS place on the MEDIUM WIRE RACK food which requires less cooking time: it will thus be easier to remove the upper pan.
Take the grill out and finish cooking the food underneath.

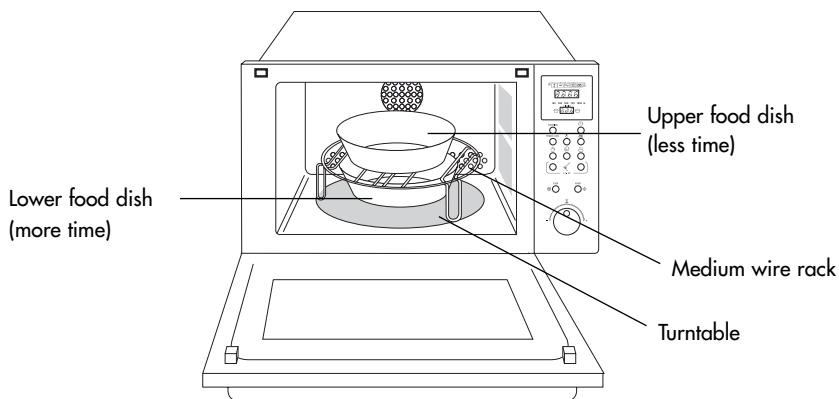

- 3) Pay strict attention to the indications and recommendations in the tables. In particular, always check to be sure that the food being reheated is very hot before removing it from the oven.

REFERENCE TABLES FOR COOKING ON TWO LEVELS

Defrosting times

Type	Pan position	Quantity (grams)	Power level	Minutes	Notes
• Ground meat	above	500	* 0	20	Turn the meat over after 10 min. When the cooking is finished, let the meat sit for 15 min.
• Ground meat	below	500	* 0	20	
• Chicken in pieces	above	500	* 0	24	During the defrosting, pull the pieces apart. When the cooking is finished, let the meat sit for 15 min.
• Stew	below	500	* 0	24	
• Cauliflower	above	450	* 0	22	At the end, let sit for 5 to 10 min.
• Whole fish	below	500	* 0	22	At the end, let sit for 5 to 10 min.

Reheating times

Type	Pan position	Quantity (grams)	Power level	Minutes	Notes
• Meat, single serving	above	150	1000	6	Cover the food with plastic wrap
• Vegetables, single serving	below	250	1000	6	Cover the food with plastic wrap
• Plate of lasagne	above	500	1000	9	Cover the food with plastic wrap
• Plate of lasagne	below	500	1000	9	Cover the food with plastic wrap
• Meat, single serving	above	150	1000	6	Cover the food with plastic wrap
• Plate of lasagne	below	500	1000	8	Cover the food with plastic wrap

Cooking times

Type	Pan position	Quantity (grams)	Power level	Minutes	Notes
• Potatoes	above	500	1000	16	Cut in equal-size pieces and cover with plastic wrap.
• Potatoes	below	500	1000	16	Cut in equal-size pieces and cover with plastic wrap.
• Carrots	above	500	1000	18	Cut in equal-size pieces and cover with plastic wrap.
• Carrots	below	500	1000	18	Cut in equal-size pieces and cover with plastic wrap.
• Zucchini	above	475	1000	14	Leave whole and cover with plastic wrap. After 14 min., take out the rack.
• Sliced fish	below	400	1000	16	Cover with plastic wrap.
• Zucchini	above	475	1000	13	Leave whole and cover with plastic wrap. After 13 min., take out the rack.
• Whole fish	below	200	1000	14	Cover with plastic wrap.
• Whole fish	above	200	1000	14	Cover with plastic wrap.
• Whole fish	below	200	1000	14	Cover with plastic wrap.
• Potatoes	above	500	1000	16	Cut in equal-size pieces and cover with plastic wrap.
• Goulash	below	1500	1000	40	After 16 min., take out the grill. Stir 2 or 3 times.
• Cabbage	above	500	1000	14	Leave whole and cover with plastic wrap. After 14 min., take out the rack.
• Rice	below	300	1000	20	Cover with plastic wrap and stir 2 times
• Brussels sprouts	above	500	1000	14	Cover with plastic wrap. After 14 min., take out the rack.
• Peas	below	500	1000	18	Cover with plastic wrap.

CHAPTER 5 - CARE AND CLEANING

5.1 - CLEANING

Always switch off at the power socket, disconnect the plug and wait for the appliance to cool down, before any cleaning and maintenance is carried out.

The internal cavity of your oven is covered with a special non-stick finish to which splashes and food particles do not stick, making cleaning particularly simple. Always keep the microwave outlet cover (C) clean and free from grease and splashes of fat.

Do not use abrasive detergents, wire sponges and sharp metal tools when cleaning the external surface of the oven. Also be careful to ensure that water or liquid detergent does not penetrate the air and steam vent grilles on the top of the appliance. It is also advisable not to use alcohol, abrasive detergents or ammonia-based detergents to clean the internal and external surfaces of the door.

Always keep the inside of the door clean to ensure that it closes properly, so that dirt and food residues do not become trapped between the door and the front panel of the oven.

It is necessary to remove the turntable (H) and its corresponding support (I) periodically in order to clean them; the bottom of the oven should also be cleaned.

Wash the turntable and its support in soapy water using mild soap. They can also be washed in a dishwasher.

Do not immerse the turntable in cold water after prolonged heating; the sudden change in temperature would cause it to crack.

To make the cleaning of the inside of the oven easier, the upper heating element can be lowered by turning the ceramic hook.

IMPORTANT: After cleaning, reposition and refasten the electrical element. The oven must not be used with the element in the lowered positioned.

The turntable motor is sealed. When cleaning the bottom, you should nevertheless take care to avoid water penetrating under the turntable spindle (D) or leaking from the holes in the bottom of the oven (see figure).

How to clean the pasta cooker accessory.

The container, cover and mixer can be washed in a dishwasher.

You are recommended to remove the central shaft from the container.

The central shaft is fixed in the container. However, it can be removed for cleaning by rotating it until the tongues match the relative holes and pressing lightly downwards.

Make sure the hatch in the cover is always clean and free to rotate/open. The water drain holes should also be kept clean.

Make sure the accessories are completely dry before repeating the cooking cycle.

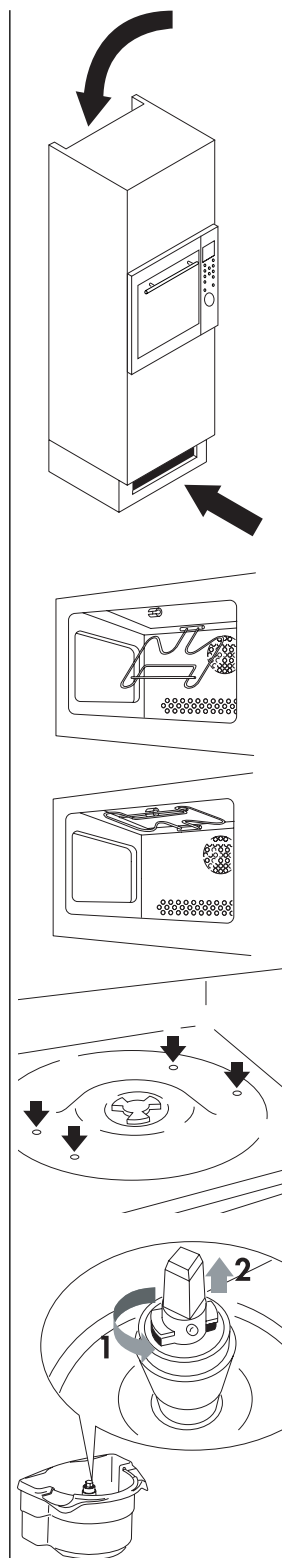

5.2 - MAINTENANCE

Before calling Service for assistance, check through the following list, there may be nothing wrong:

PROBLEM	CAUSE/SOLUTION
The appliance does not work	<ul style="list-style-type: none">• The door is not closed properly.• The plug is not correctly inserted.• No power at the socket No power at the socket (check the fuse box)
Condensation on the work surface, inside the oven or around the door.	<ul style="list-style-type: none">• When food is cooked which contains water it is quite normal for the steam which is generated inside the oven to escape and condense inside the oven, on the cooking surface or around the doorframe.
Sparks inside the oven	<ul style="list-style-type: none">• Do not turn the oven on without food in Microwave and Combined cooking modes.• Do not use metal containers for the above cooking modes or bags or packets with metal parts.
The food does not heat or cook properly	<ul style="list-style-type: none">• Select the correct cooking mode or reduce the cooking time.• The food has not been completely defrosted before being cooked.
The food burns	<ul style="list-style-type: none">• Select the correct cooking mode or reduce the cooking time.
The food does not cook evenly	<ul style="list-style-type: none">• Stir the food during cooking. Remember that food cooks better when cut in evenly-sized pieces.• The turntable does not rotate.
PASTA mode cannot be set, PASTA is not displayed	<ul style="list-style-type: none">• Make sure the pasta support is correctly inserted in the bottom of the oven and that the pins correspond to the relative holes. The container must be correctly positioned over the pasta support.

NOTE: The oven may be used safely even if the light bulb is not working. Contact an authorised Service Centre for bulb replacement.



After Sales Service

“No company is better positioned to offer an after sales service on a Hotpoint appliance than us - the manufacturer”

As part of our commitment to you, all Hotpoint appliances have the added benefit of a fully inclusive parts and labour guarantee for the first 12 months. In addition to this you also have the advantage of **free replacement parts for the first 5 years** when fitted by a Hotpoint engineer. When the 12 months parts and labour guarantee expires we offer the following after sales service options:

Repair Service and Information Help Desk

UK: 08709 066 066

www.hotpointservice.co.uk

Republic of Ireland: 1850 302 200

Note: Our operators will require the Model number and the Serial number of your appliance.

Available 364 days of the year with a fast, effective and value for money service. We have the largest white goods repair service in the UK, with over 1000 of our own fully trained engineers. All repairs include a parts and labour guarantee for 12 months from the date of repair.

If you require any information or have any questions about your appliance, our operators are on hand with help and advice.

All this ensures that you will receive the best available after sales service possible.

Extended Warranties

UK: 08709 088 088

www.hotpointservice.co.uk

Republic of Ireland: 1850 502 200

Whether you have just one or a number of Hotpoint appliances in your kitchen, we offer two service cover plans to give you total peace of mind.

- Repair Protection Plan - FREE service repairs for a single Hotpoint appliance during the period of cover.
- Kitchen Cover - FREE service repairs for all your Hotpoint appliances less than 8 years old.

Genuine Parts and Accessories

UK: 08709 077 077

www.hotpointservice.co.uk

Republic of Ireland: (01) 842 6836

A wide range of genuine parts and accessories are available from our hotline or through our web site. **Genuine parts and accessories, extended warranties and service repairs are all available on our web-site at:**

www.hotpointservice.co.uk

Hotpoint

Guarantee

“Satisfaction guaranteed or your money back”

We give you a unique ‘satisfaction guaranteed’ promise - **valid for 90 days** - after you have purchased your Hotpoint appliance. If there is a technical problem simply call Hotpoint Repair Service or visit our web-site at www.hotpointservice.co.uk and where necessary, we will arrange for an engineer to call. If the technical problem is not resolved under this guarantee, **we will replace your appliance or, if you prefer, give you your money back.**

All Hotpoint appliances carry a fully inclusive 12 months parts and labour guarantee as well as free replacement parts for the first 5 years (except microwaves, selected integrated appliances and cooker hoods, which have a one year guarantee) provided that they are fitted by a Hotpoint engineer.

Guarantee terms and conditions

Your guarantee is only applicable in the United Kingdom or Republic of Ireland and is subject to the following provisions that your appliance:

- Has been installed and used correctly in accordance with this instruction booklet.
- Has been used solely for domestic purposes and is located on domestic premises (ie. not for commercial or trade use).
- Has been properly connected to a suitable electrical supply voltage as stated on the appliance rating plate.
- Has not been subject to misuse, accident, modified or repaired by anyone other than one of our own service engineers.



For pre-purchase information on any other Hotpoint product call: 08701 50 60 70
or visit: www.hotpointservice.co.uk



Recycling & Disposal Information

As part of Hotpoint’s continued commitment to helping the environment, Hotpoint reserves the right to use quality recycled components to keep down customer costs and minimise material wastage.

Please dispose of packaging and old appliances carefully.

To minimise risk of injury to children, remove the door, plug and cut mains cable off flush with the appliance. Dispose of these parts separately to ensure that the appliance can no longer be plugged into a mains socket, and the door cannot be locked shut.



Key Contacts

After Sales Service

Over 1000 trained specialists, directly employed by us, ensure that you can have complete confidence in both the appliances and services we offer.

Repair Service and Information Desk

UK: 08709 066 066

(Open 8 to 8 Mon-Fri, 8 to 5,30 Sat, 10 to 4 Sun & Bank Holidays)

www.hotpointservice.co.uk

Republic of Ireland: 1850 302 200

Note: Our operators will require the following information:

Model number:

Serial number:

Extended Warranties

UK: 08709 088 088

(Open 8 to 8 Mon-Sun)

www.hotpointservice.co.uk

Republic of Ireland: 1850 502 200

Genuine Parts and Accessories

UK: 08709 077 077

(Open 8.30 to 5.30 Mon-Fri, 9 to 12 Sat)

www.hotpointservice.co.uk

Republic of Ireland: (01) 842 6836

Merloni elettrodomestici UK Ltd, Morley Way, Peterborough, PE2 9JB

Free Manuals Download Website

<http://myh66.com>

<http://usermanuals.us>

<http://www.somanuals.com>

<http://www.4manuals.cc>

<http://www.manual-lib.com>

<http://www.404manual.com>

<http://www.luxmanual.com>

<http://aubethermostatmanual.com>

Golf course search by state

<http://golfingnear.com>

Email search by domain

<http://emailbydomain.com>

Auto manuals search

<http://auto.somanuals.com>

TV manuals search

<http://tv.somanuals.com>