



Instructions for Installation and Use

Electric Oven Models: SE1002X

To the Installer

Before installation fill in the product details on the back cover of this book.
The information can be found on the rating plate.

To the User

You must read the instructions prior to installing and using the appliance and
then retain them for future reference.

GB

Retention of this Instruction Book

This Instruction Book must be kept handy for reference as it contains important details on the safe and proper use of the appliance.

If you sell or pass the appliance to someone else, or move house and leave it behind, make sure this Book is also provided so the new owner can become familiar with the appliance and safety warnings.

If the Book is lost or damaged a copy may be obtained from:

Merloni Elettrodomestici LTD., Morley Way,
Peterborough, PE2 9JB

Contents

Introduction, 3

Installation, 4

Positioning

Electrical connection, 5

Data plate

Description of the appliance, 6

Overall view

Control panel

Start-up and use, 7

Setting the clock and timer

Starting the oven

Control Panel Lock

DEMO mode

Cooking modes, 8-10

Cooking modes

Programming your cooking

Practical cooking advice

Cooking advice table

Precautions and tips, 11

General safety

Disposal

Respecting and conserving the environment

Maintenance and care, 12

Switching the appliance off

Cleaning the appliance

Cleaning the oven door

Replacing the light bulb

Sliding Rack Kit assembly, 13

After Sales Service, 14

Hotpoint Guarantee, 15

Key Contacts, Back Cover

Introduction

Your new electric oven is guaranteed* and will give lasting service. This guarantee is only applicable if the appliance has been installed in accordance with the installation instructions detailed in this booklet.

To help make best use of your cooking equipment, please read this booklet carefully.

The oven is designed specifically for domestic use and responsibility will not be accepted for use in any other installation.

! When the oven is first used, an odour may be omitted - this will cease after a short period of use.

To help remove the 'new' smell, heat the empty oven to maximum temperature for a minimum of two to three hours, keeping the door/s closed. Ensure that the room is well ventilated (eg. open a window or use an extractor fan) and that persons who may be sensitive to the odour avoid any fumes. It is suggested that any pets be removed from the room until the smell has ceased.

This odour is due to any temporary finish on oven linings and elements and any moisture absorbed by the insulation.

GB

! The guarantee is subject to the provisions that the appliance:

- (a) Has been used solely in accordance with this booklet.**
- (b) Has been properly connected to a suitable supply voltage as stated on the rating plate, attached to the appliance.**
- (c) Has not been subjected to misuse or accident or been modified or repaired by any person other than the manufacturers authorised employee or agent.**
- (d) Has been correctly installed.**

Installation

GB

! Before placing your new appliance into operation please read these operating instructions carefully. They contain important information for safe use, for installation and for care of the appliance.

! Please keep these operating instructions for future reference. Pass them on to possible new owners of the appliance.

Positioning

! Keep packaging material out of the reach of children. It can become a choking or suffocation hazard. (see *Precautions and tips*).

! The appliance must be installed by a qualified person in compliance with the instructions provided. Incorrect installation may cause harm to persons, animals or may damage property.

Fitting the appliance

Use the appropriate cabinet to ensure that the appliance functions properly.

- The panels adjacent to the oven must be made of heat-resistant material.
- Cabinets with a veneer exterior must be assembled with glues which can withstand temperatures of up to 100°C.
- To install the oven **under the counter** (see *diagram*) and in a **kitchen unit**, the cabinet must have the following dimensions:

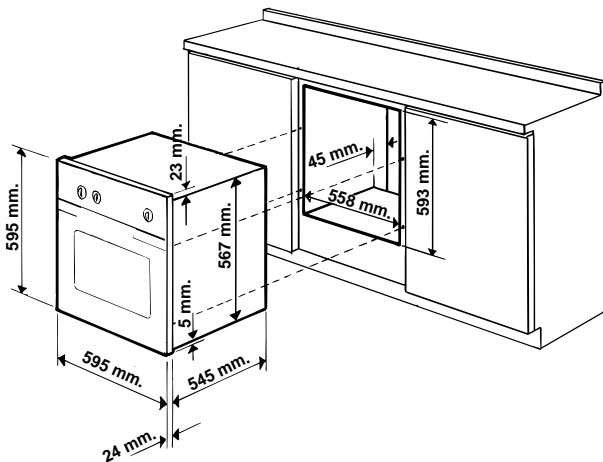

! The appliance must not come into contact with electrical parts once it has been installed. The consumption indications on the data plate have been calculated for this type of installation.

Ventilation

To ensure good ventilation, the back panel of the cabinet must be removed. It is advisable to install the oven so that it rests on two strips of wood, or on a completely flat surface with an opening of at least 45 x 560 mm (see *diagrams*).

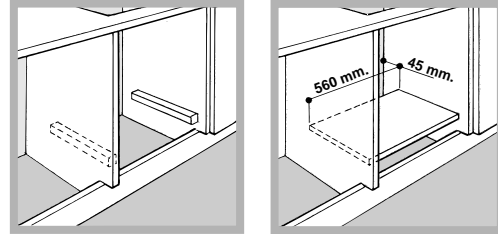

Centring and fastening

Position the 4 tabs on the side of the oven according to the 4 holes of the outer frame. Adjust the tabs according to the thickness of the cabinet side panel, as shown below:

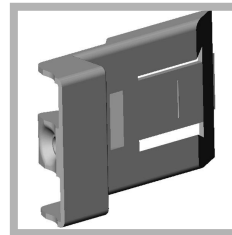

thickness of 20 mm: take off the removable part of the tab (see *diagram*)

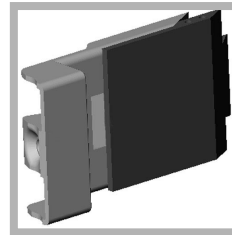

thickness of 18 mm: use the first groove, which has already been set in the factory (see *diagram*)

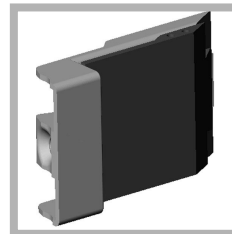

thickness of 16 mm: use the second groove (see *diagram*)

Secure the appliance to the cabinet by opening the oven door and putting 4 screws into the 4 holes of the outer frame.

! All parts which ensure the safe operation of the appliance must not be removable without the aid of a tool.

Electrical Connection

Electrical connection

The electrical connection to the mains must be made on the appliance. The power voltage and frequency are as indicated on the rating plate.

! THIS APPLIANCE MUST BE EARTHED.

Connecting the power supply cable

To open the terminal board:

- Using a screwdriver, press on the tabs situated on each side of the terminal board cover.
- Pull open the terminal board cover.

To connect the power supply cable, proceed as follows:

- Unscrew the cable clamp screw and the contact screws L-N- \equiv .
- Fasten the wires beneath the screwheads using the following colour scheme: **Blue** (N) **Brown** (L) **Yellow-Green** \equiv
- Fasten the power supply cable in the corresponding cable clamp and close the cover.

Electrical Connection:

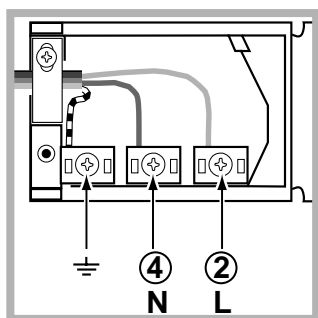

Voltage Frequency: 230 V-1+N 50Hz
Fuse Section: 16A
Supply cable: 3x1.5mm²

You can connect your oven to the system means of a terminal board. Refer to above information for the minimal cable sections and the calibration of the protective elements according to the connection. If the appliance is installed **with a junction box**, an **omnipolar circuit breaker** - with a minimum contact opening of 3mm - should be installed between the appliance and the mains.



Power cable supply connection to the electrical mains:

We recommend you use a power supply cable which is long enough to allow you to take the oven out of its recess in the event of maintenance operations (only use HAR - H 05 - RRF quality cables fitted with a plug conforming to the regulations in force. The plug must be accessible at all times.

Unplug the appliance before all operations, even when replacing the oven lamp.

Using the appliance without correct earthing is highly dangerous.

! After connecting the appliance to the flexible cable, tighten all the screws on the terminal board.

DATA PLATE	
Dimensions	width cm 37.5 height cm 32 depth cm 41.5
Volume	lt. 50
Electrical connections	voltage: 230-240V ~ 50Hz / maximum power absorbed 2800W-3000W
ENERGY LABEL	Directive 2002/40/EC on the label of electric ovens. Standard EN 50304
Control programs in accordance with standard IEC456	Energy consumption for Natural convection – heating mode:  Convection mode Declared energy consumption for Forced convection Class – heating mode:  Baking
	This appliance conforms to the following European Economic Community directives: 73/23/EEC of 19/02/73 (Low Voltage) and subsequent amendments; -89/336/EEC of 03/05/89 (Electromagnetic Compatibility) and subsequent amendments; 93/68/EEC of 22/07/93 and subsequent amendments.

Description of the appliance

GB

Overall view

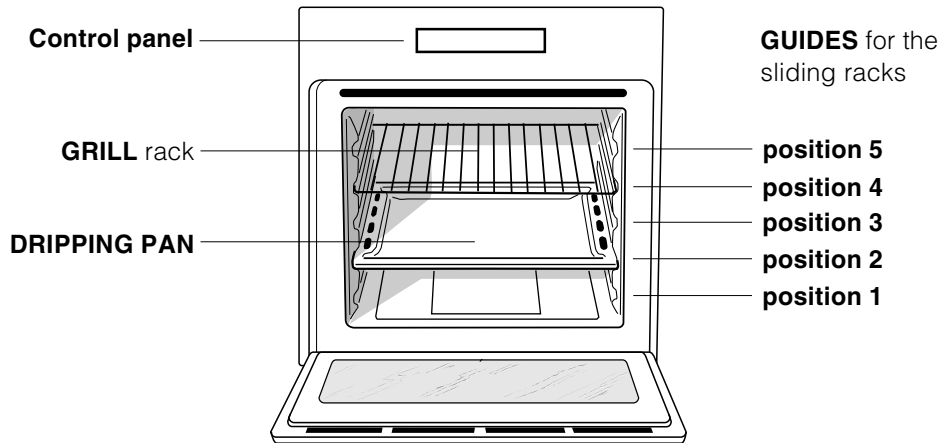

Control panel

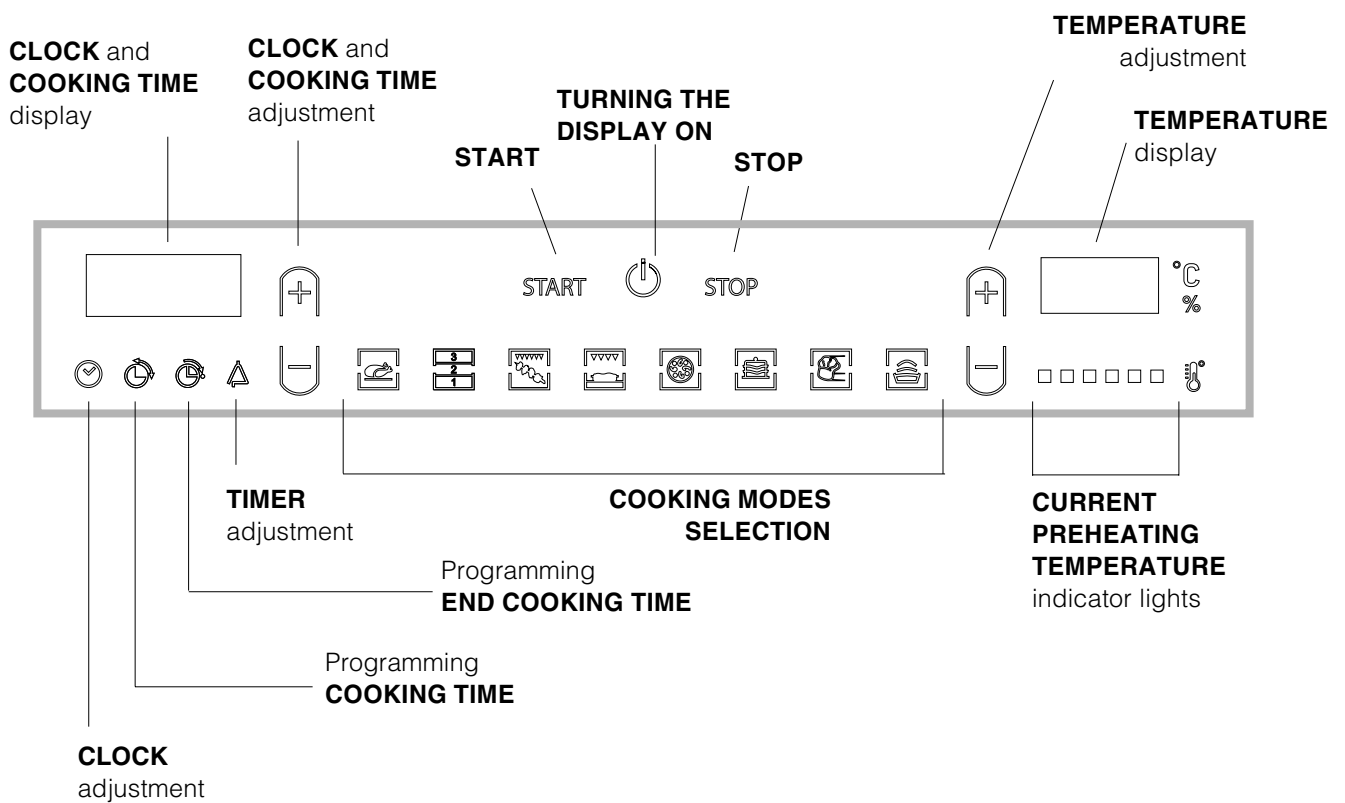



Start-up and use

! The first time you use your appliance, heat the empty oven with its door closed at its maximum temperature for at least half an hour. Ensure that the room is well ventilated before switching the oven off and opening the oven door. The appliance may produce a slightly unpleasant odour caused by the burning away of protective substances used during the manufacturing process.

! The "Control panel lock" and "DEMO mode" can be activated/deactivated even when the control panel is off.





Control panel lock

To lock the oven controls, press  and  for 5 seconds. A buzzer sounds and the TEMPERATURE display shows "r-0".

Press again to unlock the controls. The "STOP" symbol remains always active.

DEMO mode



The oven can operate in DEMO mode: all heating elements are deactivated, and controls remain operative.

To activate the DEMO mode, press , , , and  at the same time. A buzzer sounds and the two displays show "demo" "on". Press again to deactivate the DEMO mode: a buzzer sounds and the two displays show "demo" "off".

Setting the clock and timer

After the appliance has been connected to the mains, or after a blackout,  will begin to blink.

To set the time:

1. press 
2. set the time using "+" and "-" on the left side of the control panel
3. press  again
4. set the minutes using "+" and "-" on the left side of the control panel.

To make any changes, turn on the control panel by pressing , then press  and follow the steps described above.

The timer operates in minutes: when the selected time has elapsed, a buzzer will sound. The buzzer will automatically stop after one minute or when any active symbol on the control panel is pressed.

To set the timer, press  and follow the steps

described to set the clock. The  symbol will remind you that the timer is on.

! The timer does not turn the oven on or off.

Starting the oven

1. Press  to turn on the control panel.
2. Press the symbol of the desired cooking mode. The displays show the time and temperature of the selected cooking mode.
3. Press "START".
4. The oven will start the preheating phase, and the current preheating temperature indicator lights turn red. The temperature may be changed by pressing "+" and "-" on the right side of the control panel.
3. When preheating is finished, a buzzer sounds and all instant temperature indicator lights turn on: place the food in the oven.
4. You may do the following during cooking:
 - change the temperature by pressing "+" and "-" on the right side of the control panel
 - set the cooking time (*see Cooking Modes*)
 - press "STOP" to interrupt cooking.
5. The oven switches off automatically after two hours: this default time is set for all cooking modes for safety reasons.
The cooking time may be changed (*see Cooking Modes*).
6. In case of a blackout, if the oven was already operating, an automatic system within the appliance will reactivate the cooking mode from where it was interrupted as long as the temperature did not drop below a certain level. Programmed cooking modes which have not started will not be restored and must be reprogrammed.

! There is no preheating in the FAST COOKING and BARBECUE modes.

! Never put objects directly on the oven bottom to avoid damaging the enamel coating.

! Always place cookware on the rack(s) provided.

Cooling ventilation

In order to cool down the external temperature of the oven, a cooling fan blows air between the control panel and the oven door. In the FAST COOKING mode, the fan goes on automatically after ten minutes.

In the BAKING mode, the cooling fan goes on only when the oven is hot. At the beginning of the FAST CLEAN mode, the cooling fan operates at low speed.

! Once the cooking has been completed, the cooling fan remains on until the oven has cooled down sufficiently.

Cooking modes

GB

Cooking modes

! All cooking modes have a default cooking temperature which may be adjusted manually between 40°C and 250°C as desired. In the BARBECUE mode, the default power level value is indicated as a percentage (%) and may also be adjusted manually.

TRADITIONAL OVEN mode

Both the top and bottom heating elements will come on. With this traditional cooking mode, it is best to use one cooking rack only; if more than one rack is used, the heat will be distributed unevenly.

MULTI-COOKING mode

All the heating elements (top, bottom and circular), as well as the fan, will come on. Since the heat remains constant throughout the oven, the air cooks and browns food uniformly. A maximum of two racks may be used at the same time.

BARBECUE mode

The top heating element come on. By pressing "+" and "-" on the right side of the control panel, the power levels that may be set will appear on the TEMPERATURE display; these range between 50% and 100%. The high and direct temperature of the grill is recommended for food that requires high surface temperature. Always cook in this mode with the oven door closed.

GRATIN mode

The top heating element as well as the fan come on. This combination of features increases the effectiveness of the unidirectional thermal radiation of the heating elements through forced circulation of the air throughout the oven.

This helps prevent food from burning on the surface, allowing the heat to penetrate right into the food. Always cook in this mode with the oven door closed.

PIZZA mode

The heating elements (bottom and circular) and the fan come on. This combination heats the oven rapidly by producing a considerable amount of heat, particularly from the bottom element. If you use more than one rack simultaneously, switch the position of the dishes halfway through the cooking process.

BAKING mode

The rear heating element and the fan come on, guaranteeing the distribution of heat delicately and uniformly throughout the oven. This mode is ideal for baking and cooking temperature sensitive foods such as cakes that need to rise and to prepare certain tartlets on 3 shelves simultaneously.

FAST COOKING mode

The heating elements and the fan come on, guaranteeing the distribution of heat consistently and uniformly throughout the oven. Pre-heating is not necessary for this cooking mode. This mode is especially recommended for cooking pre-packed food quickly (frozen or pre-cooked). The best results are obtained if you use one cooking rack only.

LEAVENING mode

The oven reaches and maintains a temperature of 40°C and cannot be changed. This mode is ideal for leavening dough made with yeast.

FAST CLEAN mode

This mode cleans the oven automatically and thoroughly by pyrolysis (*see Maintenance and care*).

Programming your cooking



! Select a cooking mode before programming.



Programming Time



Press , then:

1. Set the time using “+” and “-” on the left side of the control panel.
2. Press  to store the setting.
3. Press “START” to activate programming.
4. When the selected time has elapsed, END appears on the TEMPERATURE display and a buzzer sounds.
 - For example: it is 9:00 a.m. and a time of 1 hour and 15 minutes is programmed. The programme stops automatically at 10:15 a.m.

Programming Delayed Cooking

1. Press  and repeat steps 1 to 4 as described in the Programming Time procedure.
2. Then press  and set the end time using “+” and “-” on the left side of the control panel.
3. Press  to store the setting.
4. Press “START” to activate programming.
5. When the selected time has elapsed, END appears on the TEMPERATURE display and a buzzer sounds.
 - For example: it is 9:00 a.m. and a time of 1 hour and 15 minutes is programmed and the end time is set to 12:30. The programme starts automatically at 11:15 a.m.

Programming has been set when  and  flash. The CLOCK and COOKING TIME displays show the end time and the cooking time alternately. To cancel programming press “STOP”.

! When selecting a cooking mode,  is illuminated whereas  is not. When setting the cooking time,  is illuminated and delayed cooking can be programmed.

Practical cooking advice

! Do not place racks in position 1 and 5 during fan-assisted cooking. Excessive direct heat can burn temperature sensitive foods.

! In the BARBECUE and GRATIN cooking modes, particularly when using the rotisserie, place the dripping pan in position 1 to collect cooking residues (fat and/or grease).

MULTI-COOKING

- Use position 2 and 4, placing the food that requires more heat on 2.
- Place the dripping pan on the bottom and the rack on top.

BARBECUE

- Insert the rack in position 3 or 4. Place the food in the centre of the rack.
- We recommend that you set the maximum power level. The top heating element is regulated by a thermostat and may not always be on.

PIZZA MODE

- Use a light aluminium pizza pan. Place it on the rack provided. For a crispy crust, do not use the dripping pan (prevents crust from forming by extending cooking time).
- If the pizza has a lot of toppings, we recommend adding the mozzarella cheese on top of the pizza halfway through the cooking process.

Cooking advice table

Cooking modes	Foods	Weight (in kg)	Rack position	Pre-heating time (min)	Recommended temperature	Cooking time (minutes)
Convection Oven	Duck	1	3	15	200	65-75
	Roast veal or beef	1	3	15	200	70-75
	Pork roast	1	3	15	200	70-80
	Biscuits (short pastry)	-	3	15	180	15-20
	Tarts	1	3	15	180	30-35
Multi-cooking	Pizza (on 2 racks)	1	2 e 4	15	230	15-20
	Lasagne	1	3	10	180	30-35
	Lamb	1	2	10	180	40-45
	Roast chicken + potatoes	1+1	2 e 4	15	200	60-70
	Mackerel	1	2	10	180	30-35
	Plum cake	1	2	10	170	40-50
	Cream puffs (on 2 racks)	0.5	2 e 4	10	190	20-25
	Biscuits (on 2 racks)	0.5	2 e 4	10	180	10-15
	Sponge cake (on 1 rack)	0.5	2	10	170	15-20
	Sponge cake (on 2 racks)	1	2 e 4	10	170	20-25
Savoury pies	1.5	3	15	200	25-30	
Barbecue	Soles and cuttlefish	0.7	4	-	100%	10-12
	Squid and prawn kebabs	0.6	4	-	100%	8-10
	Cuttlefish	0.6	4	-	100%	10-15
	Cod filet	0.8	4	-	100%	10-15
	Grilled vegetables	0.4	3 o 4	-	100%	15-20
	Veal steak	0.8	4	-	100%	15-20
	Sausages	0.6	4	-	100%	15-20
	Hamburgers	0.6	4	-	100%	10-12
	Mackerels	1	4	-	100%	15-20
	Toasted sandwiches (or toast)	n.° 4 e 6	4	-	100%	3-5
	With rotisserie (where present)					
	Veal on the spit	1.0	-	-	100%	80-90
Chicken on the spit	1.5	-	-	100%	70-80	
Lamb on the spit	1.0	-	-	100%	70-80	
Gratin	Grilled chicken	1.5	2	10	200	55-60
	Cuttlefish	1.5	2	10	200	30-35
Pizza Mode	Pizza	0.5	3	15	220	15-20
	Roast veal or beef	1	2	10	220	25-30
	Chicken	1	2 o 3	10	180	60-70
Oven Baking	Tarts	0.5	3	15	180	20-30
	Fruit cakes	1	2 o 3	15	180	40-45
	Plum cake	0.7	3	15	180	40-50
	Sponge cake	0.5	3	15	160	25-30
	Stuffed pancakes (on 2 racks)	1.2	2 e 4	15	200	30-35
	Small cakes (on 2 racks)	0.6	2 e 4	15	190	20-25
	Cheese puffs (on 2 racks)	0.4	2 e 4	15	210	15-20
	Cream puffs (on 3 racks)	0.7	1 e 3 e 5	15	180	20-25
	Biscuits (on 3 racks)	0.7	1 e 3 e 5	15	180	20-25
	Meringues (on 3 racks)	0.5	1 e 3 e 5	15	90	180
Fast cooking	Frozen food					
	Pizza	0.3	2	-	250	12
	Courgette and prawn pie	0.4	2	-	200	20
	Country style spinach pie	0.5	2	-	220	30-35
	Turnovers	0.3	2	-	200	25
	Lasagne	0.5	2	-	200	35
	Golden Rolls	0.4	2	-	180	25-30
	Chicken morsels	0.4	2	-	220	15-20
	Pre-cooked food					
	Golden chicken wings	0.4	2	-	200	20-25
	Fresh Food					
	Biscuits (short pastry)	0.3	2	-	200	15-18
	Plum cake	0.6	2	-	180	45
Cheese puffs	0.2	2	-	210	10-12	
Leavening	Leavening process of dough made with yeast or baking powder (brioches, bread, sugar pie, croissants, etc.)					

Precautions and tips

! The appliance was designed and manufactured in compliance with international safety standards. The following warnings are provided for safety reasons and must be read carefully.

General safety

- The appliance was designed for domestic use inside the home and is not intended for commercial or industrial use.
- The appliance must not be installed outdoors, even in covered areas. It is extremely dangerous to leave the appliance exposed to rain and storms.
- When handling the appliance, always use the handles provided on the sides of the oven.
- Do not touch the appliance with bare feet or with wet or moist hands and feet.
- The appliance must be used to cook food by adults only and according to the instructions in this manual.
- **When the appliance is in use, the heating elements and some parts of the oven door become extremely hot. Make sure you don't touch them and keep children well away.**
- Ensure that the power supply cable of other electrical appliances does not come into contact with the hot parts of the oven.
- The openings used for ventilation and dispersion of heat must never be covered.
- Always grip the oven door handle in the centre: the ends may be hot.
- Always use oven gloves to place cookware in the oven or when removing it.
- Do not use aluminium foil to line the bottom of the oven.
- Do not place flammable materials in the oven: if the appliance is switched on by mistake, it could catch fire.
- When unplugging the appliance always pull the plug from the mains socket, do not pull on the cable.

- Never carry out any cleaning or maintenance work without having unplugged the plug from the mains.
- In the case of a malfunction, under no circumstances should you attempt to repair the appliance yourself. Repairs carried out by inexperienced persons may cause injury or further malfunctioning of the appliance. Contact a Service Centre (*see Assistance*).
- Do not rest heavy objects on the open oven door.

Disposal

- Observe local environmental standards when disposing packaging material for recycling purposes. Observe existing legislation when disposing of the old appliance.
- Contact your Local Organisation in charge of waste disposal.
- Make the appliance unusable by cutting off the electrical cable before disposal.

Respecting and conserving the environment

- By using the appliance in the hours between late afternoon and early morning, you can help reduce the work load placed on electrical companies. The cooking mode programming options, and particularly the “delayed cooking” mode (*see Cooking modes*), make this possible.
- Always keep the oven door closed when using the BARBECUE and GRATIN mode to attain best results and to save energy (approximately 10%).
- Regularly check the door seals and wipe clean to ensure they are free of debris so that they stick properly to the door and do not allow heat to disperse.

Maintenance and care

GB

Switching the appliance off

Disconnect your appliance from the electricity supply before carrying out any work on it.

Cleaning the appliance

- The stainless-steel or enamel-coated external parts as well as the rubber seals may be cleaned using a sponge that has been soaked in lukewarm water and neutral soap. If these stains are difficult to remove, use only specialised products. After cleaning, rinse and dry thoroughly. Do not use abrasive powders or corrosive substances.
- Ideally, the inside of the oven should be cleaned after each use, when it is still lukewarm. Use hot water and detergent, rinse and dry with a soft cloth. Do not use abrasive products.
- The accessories can be washed like everyday crockery (even in your dishwasher).

Cleaning the oven door

Clean the glass door using non-abrasive products and sponges and dry it with a soft cloth. To clean more thoroughly, you can remove the oven door.

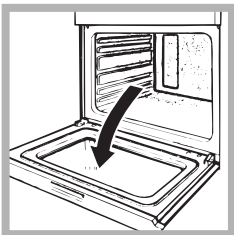

1. Open the oven door fully (*see diagram*)

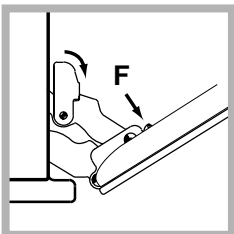

2. Lift up and turn the small levers located on the two hinges (*see diagram*)

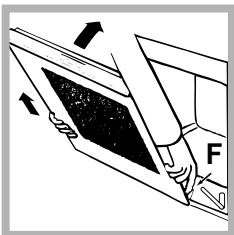

3. Grip the door on the two external sides and close it approximately half way. Unlock the door by pressing on the clamps F, then pull the door towards you lifting it out of its seat (*see diagram*). To replace the door, reverse this sequence.

Inspecting the seals

Check the door seals around the oven periodically. If the seals are damaged, please contact your nearest After-sales Service Centre (*see Assistance*). We recommend not using the oven until the seals have been replaced.

Replacing the light bulb

To replace the oven light bulb:

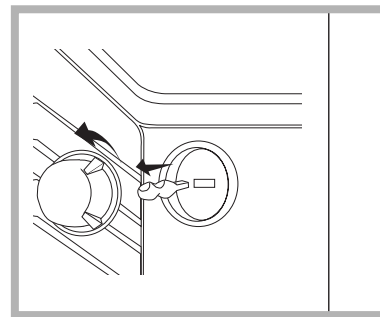

1. Remove the glass cover of the lamp-holder.
2. Remove the light bulb and replace it with a similar one: halogen lamp voltage 230V, wattage 25 W, cap G 9.
3. Replace the glass cover (*see diagram*).

! Do not touch the light bulb directly with your hands.

Warning:

The appliance is fitted with an automatic diagnostic system which detects any malfunctions. Malfunctions are displayed by messages of the type: "ER" followed by numbers.

Call for technical assistance should a malfunction occur.

Sliding Rack Kit assembly

To assemble the sliding racks:

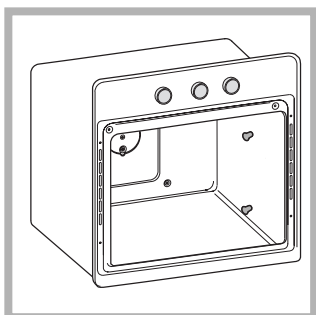

1. Loosen the two screws A (*see diagram*). If the oven is fitted with self-cleaning panels, these will have to be temporarily disassembled.

2. Replace the screws A with the screws and spacers (B + C) supplied with the kit.

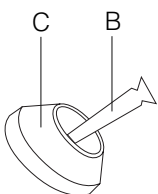

3. Tighten the new screws B and the corresponding spacers C, fitting the self-cleaning panels on again.

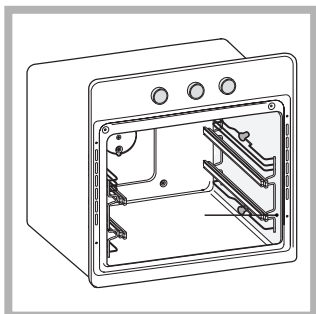

4. Secure the two joints D of the guide rail in the holes provided on the oven walls (*see diagram*). The holes for the left guide rail are situated at the top, while the holes for the right one are at the bottom.

5. Finally, fit the guide rail on the spacer C.



After Sales Service

"No company is better positioned to offer an after sales service on a Hotpoint appliance than us - the manufacturer"

As part of our commitment to you, all Hotpoint appliances have the added benefit of a fully inclusive parts and labour guarantee for the first 12 months. In addition to this you also have the advantage of

free

replacement parts for the first 5 years when fitted by a Hotpoint engineer. When the 12 months parts and labour guarantee expires we offer the following after sales service options:

Repair Service and Information Help Desk

UK: 08709 066066

www.hotpointservice.co.uk

Republic of Ireland: 1850 302 200

Note: Our operators will require the Model number and the Serial number of your appliance

Available 364 days a year with a fast, effective and value for money service. We have the largest white goods repair service in the UK with over 1000 of our own fully trained engineers. All repairs include a parts and labour guarantee for 12 months from the date of the repair.

If you require any information or have any questions about your appliance, our operators are on hand with help and advice.

All this ensures that you will receive the best available after sales service possible.

Extended Warranties

UK: 08709 088 088

www.hotpointservice.co.uk

Republic of Ireland: 1850 502 200

Whether you have just one or a number of Hotpoint appliances in your kitchen, we offer two service cover plans to give you total peace of mind.

/Repair Protection Plan - FREE service repairs for a single Hotpoint appliance during the period of cover.

/Kitchen Cover - FREE service repairs for all your Hotpoint appliances less than 8 years old.

Genuine Parts and Accessories UK: 08709 077 077

www.hotpointservice.co.uk

Republic of Ireland: (01) 842 6836

A wide range of genuine parts and accessories are available from our hotline or through our web site.

Genuine parts and accessories, extended warranties and service repairs are all available on our web-site at:

www.hotpointservice.co.uk



Guarantee

"Satisfaction guaranteed or your money back"

We give you a unique 'satisfaction guaranteed' promise - **valid for 90 days** - after you have purchased your Hotpoint appliance. If there is a technical problem simply call Hotpoint Repair service or visit our web-site at www.hotpointservice.co.uk and where necessary, we will arrange for an engineer to call. If the technical problem is not resolved under this guarantee, **we will replace your machine or, if you prefer, give you your money back.**

All Hotpoint appliances carry a fully inclusive 12 month parts and labour guarantee as well as free replacement parts for the first 5 years provided that they are fitted by a Hotpoint engineer.

Guarantee terms and conditions

Your guarantee is only applicable in the United Kingdom or Republic of Ireland and is subject to the following provisions that your appliance:

- Has been installed and used correctly in accordance with this instruction booklet.
- Has been used solely for domestic purposes and is located on domestic premises (ie. not for commercial or trade use).
- Has been properly connected to a suitable electrical supply voltage as stated on the appliance rating plate.
- Has not been subject to misuse, accident, modified or repaired by anyone other than one of our own service engineers.

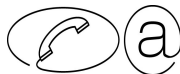

For pre purchase information on any other Hotpoint product call: 08701 50 60 70
or visit: www.hotpointservice.co.uk



Recycling & Disposal Information

As part of Hotpoint's continued commitment to helping the environment, Hotpoint reserves the right to use quality recycled components to keep down customer costs and minimise material wastage.

Please dispose of packaging and old appliances carefully.

To minimise risk of injury to children, remove the door, plug and cut mains cable off flush with the appliance. Dispose of these parts separately to ensure that the appliance can no longer be plugged into a mains socket, and the door cannot be locked shut.



Key Contacts

After Sales Service

Over 1200 trained specialists, directly employed by us, ensure that you can have complete confidence in both the appliances and services we offer.

Repair Service and Information Desk

UK: 08709 066 066

(Open 8 to 8 Mon - Fri, 8.30 to 5.30 Sat, 10 to 4 Sun & Bank Holidays)

www.hotpointservice.co.uk

Republic of Ireland: 1850 302 200

Note: Our operators will require the following information:

Model number:

Serial number:

Extended Warranties

UK: 08709 088 088

(Open 8 to 8 Mon - Sun)

www.hotpointservice.co.uk

Republic of Ireland: 1850 502 200

Genuine Parts and Accessories

UK: 08709 077 077

(Open 8-30 to 5-30 Mon - Fri & 9 to 12 Sat)

www.hotpointservice.co.uk

Republic of Ireland: (01) 842 6836

Merloni Elettrodomestici UK Ltd, Morley Way, Peterborough, PE2 9JB.

Free Manuals Download Website

<http://myh66.com>

<http://usermanuals.us>

<http://www.somanuals.com>

<http://www.4manuals.cc>

<http://www.manual-lib.com>

<http://www.404manual.com>

<http://www.luxmanual.com>

<http://aubethermostatmanual.com>

Golf course search by state

<http://golfingnear.com>

Email search by domain

<http://emailbydomain.com>

Auto manuals search

<http://auto.somanuals.com>

TV manuals search

<http://tv.somanuals.com>