

GB

English, 1

SE481012X
SE48L1012X
SE48R1012X

Contents

Installation, 2-3

Positioning

Electrical connection, 4

Data plate

Description of the appliance, 5

Overall view of classical-opening model

Overall view of side-opening model

Control panel

Start-up and use, 6-7

Control panel lock

DEMO mode

Setting the clock

Setting the timer

Starting the oven

Cooking modes, 8-11

Manual cooking modes

Automatic cooking modes

Programming cooking

Practical cooking advice

Cooking advice table

Precautions and tips, 12

General safety

Disposal

Respecting and conserving the environment

Care and maintenance, 13-14

Switching the appliance off

Cleaning the appliance

Cleaning the oven door

Replacing the light bulb

Assembling the sliding rack kit

Assistance

After Sales Service, 15

Repair Service and Information Desk

Extended Warranties

Genuine Parts and Accessories

Guarantee, 16

Installation

GB

! Before operating your new appliance please read this instruction booklet carefully. It contains important information concerning the safe operation, installation and maintenance of the appliance.

! Please keep these operating instructions for future reference. Make sure that the instructions are kept with the appliance if it is sold, given away or moved.

Positioning

! Keep all packaging materials out of the reach of children. It may present a choking or suffocation hazard (see *Precautions and tips*).

! The appliance must be installed by a qualified person in compliance with the instructions provided. Incorrect installation may cause harm to people and animals or may damage property.

Built-in appliance

Use the appropriate cabinet to ensure that the appliance functions properly.

- The panels adjacent to the oven must be made of heat-resistant material.
- Cabinets with a veneer exterior must be assembled with glues which can withstand temperatures of up to 100°C.
- To install the oven **under a counter** (see *diagram*) or in a **kitchen unit**, the cabinet must have the following dimensions:

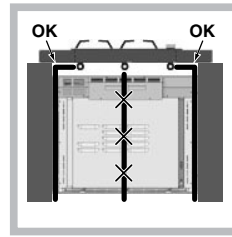
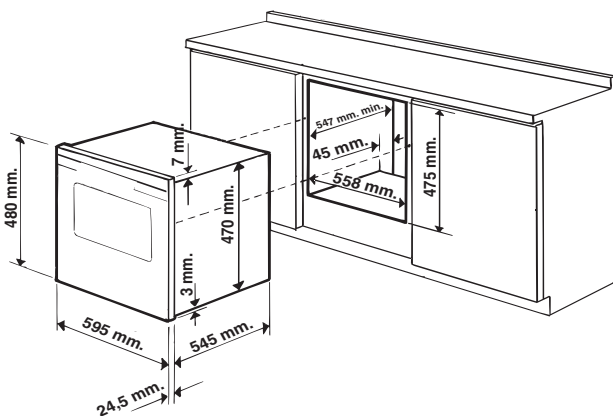

! If the appliance is fitted under the counter, make sure that the hob piping is positioned correctly and that it does not interfere with the oven during installation or obstruct the rear vents of the cooling fan.

! The appliance must not come into contact with electrical parts once it has been installed. The indications for consumption given on the data plate have been calculated for this type of installation.

Ventilation

To ensure adequate ventilation is provided, the back panel of the cabinet must be removed. It is advisable to install the oven so that it rests on two strips of wood, or on a completely flat surface with an opening of at least 45 x 560 mm (see *diagrams*).

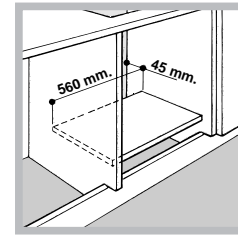
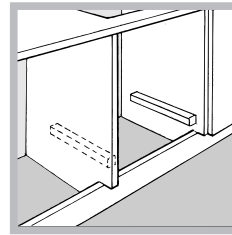

Centring and fixing

Position the 4 tabs on the side of the oven so that they are lined up with the 4 holes on the outer frame. Adjust the tabs according to the thickness of the cabinet side panel, as shown below:

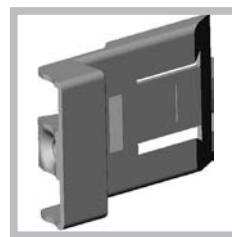

20 mm thick: take off the removable part of the tab (see *diagram*).

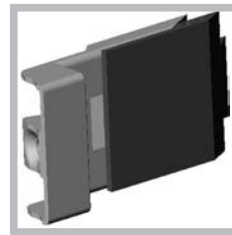

18 mm thick: use the first groove, which has already been set in the factory (see *diagram*).

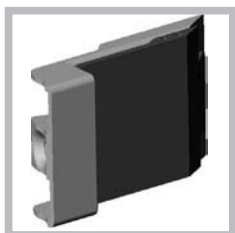

16 mm thick: use the second groove (*see diagram*).

Secure the appliance to the cabinet by opening the oven door and inserting 4 screws into the 4 holes on the outer frame.

! All parts which ensure the safe operation of the appliance must not be removable without the aid of a tool.

Electrical Connection

GB

Electrical connection

The electrical connection to the mains must be made on the appliance. The power voltage and frequency are as indicated on the rating plate.

! THIS APPLIANCE MUST BE EARTHED.

Connecting the power supply cable

To open the terminal board:

- Using a screwdriver, press on the tabs situated on each side of the terminal board cover.
- Pull open the terminal board cover.

To connect the power supply cable, proceed as follows:

- Unscrew the cable clamp screw and the contact screws L-N- \equiv .
- Fasten the wires beneath the screwheads using the following colour scheme: **Blue** (N) **Brown** (L) **Yellow-Green** \equiv
- Fasten the power supply cable in the corresponding cable clamp and close the cover.

Electrical Connection:

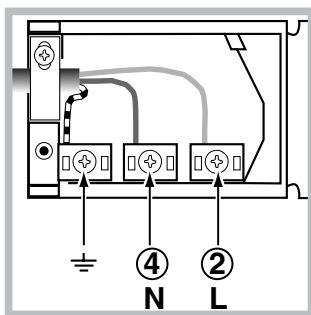

Voltage Frequency: 230 V-1+N 50Hz
Fuse Section: 16A
Supply cable: 3x1.5mm²

You can connect your oven to the system means of a terminal board. Refer to above information for the minimal cable sections and the calibration of the protective elements according to the connection. If the appliance is installed **with a junction box**, an **omnipolar circuit breaker** - with a minimum contact opening of 3mm - should be installed between the appliance and the mains.



Power cable supply connection to the electrical mains:

We recommend you use a power supply cable which is long enough to allow you to take the oven out of its recess in the event of maintenance operations (only use HAR - H 05 - RRF quality cables fitted with a plug conforming to the regulations in force. The plug must be accessible at all times.

Unplug the appliance before all operations, even when replacing the oven lamp.

Using the appliance without correct earthing is highly dangerous.

! After connecting the appliance to the flexible cable, tighten all the screws on the terminal board.

TABLE OF CHARACTERISTICS	
Dimensions *	width 43.5 cm height 32 cm depth 41.5 cm
Volume *	58 l
Electrical connections	voltage: 220-240V ~ 50/60Hz maximum power absorbed 2800 W
ENERGY LABEL *	Directive 2002/40/EC on the label of electric ovens. Regulation EN 50304 Declared energy consumption for Forced convection Class  Gratin
 	This appliance conforms to the following European Economic Community directives: 73/23/EEC dated 19/02/73 (Low Voltage) and subsequent amendments - 89/336/EEC dated 03/05/89 (Electromagnetic Compatibility) and subsequent amendments - 93/68/EEC dated 22/07/93 and subsequent amendments. 2002/96/EEC

* Without removable guide rails

Description of the appliance

Overall view of classical-opening model

GB

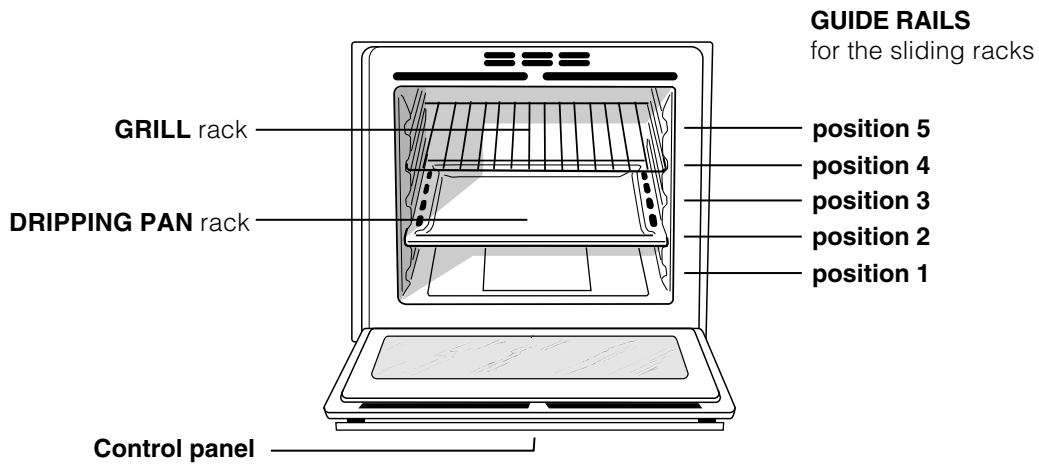

Overall view of side-opening model

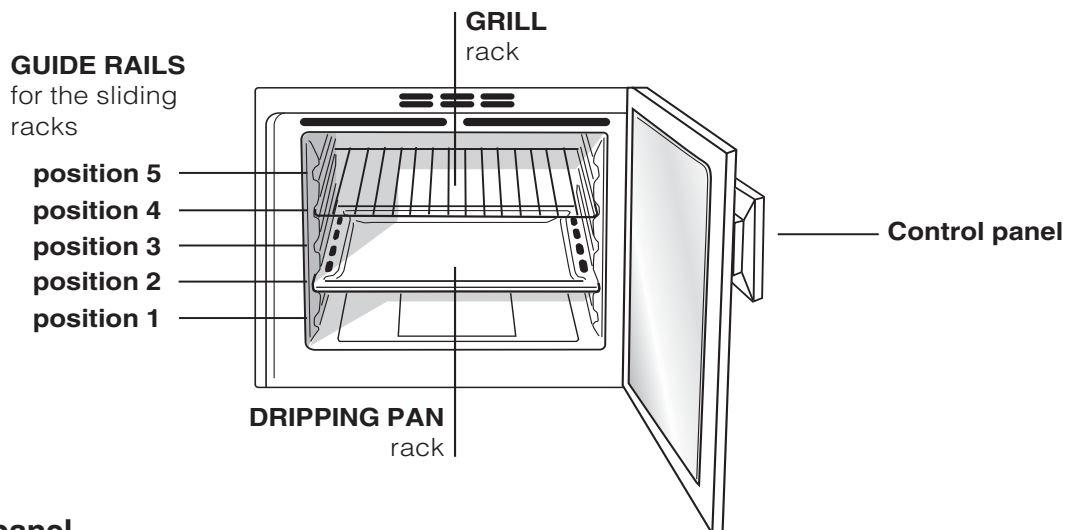

Control panel

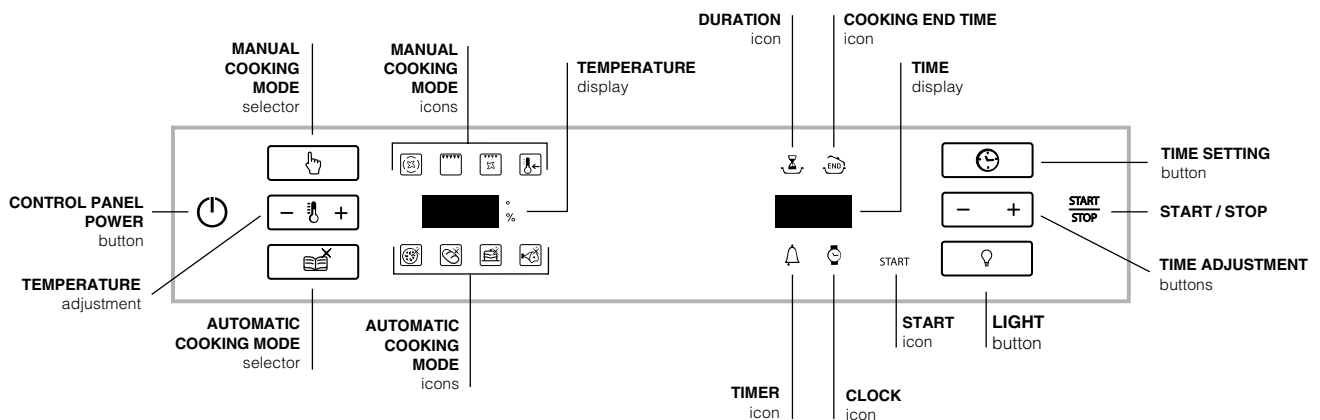

Start-up and use

GB

! The first time you use your appliance, heat the empty oven with its door closed at its maximum temperature for at least half an hour. Ensure that the room is well ventilated before switching the oven off and opening the oven door. The appliance may emit a slightly unpleasant odour caused by protective substances used during the manufacturing process burning away.

! The "Control panel lock" and "DEMO mode" can be activated/deactivated even when the control panel is switched off.

! If no button is pressed within 2 minutes of the oven being switched on, the appliance will be switched off automatically.

Control panel lock

To lock the oven controls, press the  button, the "START/STOP" button and the time "+" button on the right hand side of the control panel in sequence. A buzzer sounds and the TEMPERATURE display shows "Loc".

To unlock the oven controls, press the  button and the time "-" button on the right hand side of the control panel in sequence.

The control panel lock function can be activated when a cooking programme is in progress or when the oven is switched off, or when a cooking end time has been set and the start button pressed. The control panel lock function can also be deactivated in all the above situations and after the oven has completed the set cooking programme.

Demo mode



The oven can operate in DEMO mode: all heating elements are deactivated, and controls remain operative.

To deactivate the DEMO mode, while the oven is switched on press the ON/OFF button, the START/STOP button and the time "+" button on the right hand side of the control panel, in that order.

To deactivate the DEMO mode, while the oven is switched on press the ON/OFF button and the time "-" button on the right hand side of the control panel. A buzzer sounds and the time display shows "D off". The DEMO mode can only be activated when the oven is switched on and no cooking programme has been commenced.

Setting the clock

! The clock may be set when the oven is switched off or when it is switched on, provided that a delayed cooking cycle has not been programmed previously.

1. Press the  button several times until the 

icon and the two digits on the TIME display flash.

2. Press the "+" and "-" buttons to adjust the hours.



3. Press the  button.

4. Press the "+" and "-" buttons to adjust the minutes.

5. Press the  button again to confirm.

Setting the timer

! This may be set while the oven is switched off or while it is switched on.

1. Press the  button several times until the  icon and the three digits on the TIME display flash.

2. Press the "+" and "-" buttons to adjust the minutes;

3. Press the  button again to confirm.

Switching the oven on

Press the  button to switch the oven on or off.

Starting the oven

Press the  button to select the desired manual cooking mode. The cooking temperature and duration may be set.

Press the  button to select the desired automatic cooking mode. The cooking temperature and duration are both set to default values. The duration may be modified by $\pm 5/10$ minutes, depending on the selected cooking mode. The text "In" which appears on the TEMPERATURE display stands for "place the food IN the oven". A delayed cooking cycle may be programmed.

Begin cooking by pressing the "START/STOP" button. The oven will begin its preheating stage, and the current preheating temperature indicator lights illuminate when this stage is complete. The temperature of the manual cooking modes may be adjusted by pressing the "+" and "-" buttons on the left hand side of the control panel.

When the preheating stage is complete, a buzzer sounds and all current preheating temperature indicator lights are illuminated: place the food in the oven.

During cooking it is always possible to:

- Change the temperature by pressing the "+" and "-" buttons on the left hand side of the control panel (manual cooking modes only).

- Interrupt cooking while maintaining the set duration by pressing the START/STOP button.

- Press the  button to stop cooking.
- Set a new cooking mode (previous settings will be reset).

If a blackout occurs while the oven is already in operation, an automatic system within the appliance will reactivate the cooking mode from where it was interrupted as long as the temperature has not dropped below a certain level. Programmed cooking modes which have not started will not be restored and must be reprogrammed.

! There is no preheating stage for the BARBECUE mode.

! Never put objects directly on the bottom of the oven; this will avoid the enamel coating being damaged.

! Always place cookware on the rack(s) provided.

Cooling ventilation

In order to cool down the external temperature of the oven, a cooling fan generates a stream of air which escapes between the oven control panel and the oven door.

! Once the cooking has been completed, the cooling fan continues to operate until the oven has cooled down sufficiently.

Oven light

When the oven is not in operation, the lamp can be switched on at any time by pressing the button.

Cooking modes

GB

Manual cooking modes

! All cooking modes have a default cooking temperature which may be adjusted manually between 40°C and 250°C as desired. In the BARBECUE mode, the default power level value is indicated as a percentage (%) and may also be adjusted manually.

MULTILEVEL mode

All heating elements and the fan are activated. Since the heat remains constant throughout the oven, the air cooks and browns food in a uniform manner. A maximum of two racks may be used at the same time.

BARBECUE mode

The top heating element and the rotisserie spit (where present) are activated. By pressing the "+" and "-" buttons on the left hand side of the control panel, the power levels that may be set will appear on the TEMPERATURE display; these range between 5% and 100%. The high and direct temperature of the grill is recommended for food which requires a high surface temperature. Always cook in this mode with the oven door closed.

GRATIN mode

The top heating element and the rotisserie spit (where present) are activated and the fan begins to operate. During part of the cycle the circular heating element is also activated. This combination of features increases the effectiveness of the unidirectional thermal radiation of the heating elements through forced circulation of the air throughout the oven.

This helps prevent food from burning on the surface and allows the heat to penetrate right into the food. Always cook in this mode with the oven door closed.



LOW TEMPERATURE modes

This type of cooking can be used for proving, defrosting, preparing yoghurt and heating dishes at the required speed. The temperature options are: 40, 65, 90 °C.

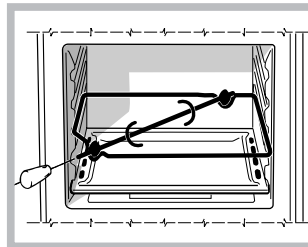
Spit roast (only available in certain models)



To operate the rotisserie spit (see diagram) proceed as follows:

1. Place the dripping pan in position 1.
2. Place the rotisserie support in position 3 and insert the spit into the hole provided on the back panel of the oven.
3. Start the spit roast function by selecting the  or  modes.

! When the  mode is activated, the rotisserie spit will stop if the door is opened.

Automatic cooking modes

! The **temperature** and **cooking duration** are **pre-set** values, guaranteeing a perfect result every time - automatically. These values are set using the **C.O.P.® (Programmed Optimal Cooking)** system. The duration may be modified by $\pm 5/10$ minutes, depending on the selected cooking mode. The cooking cycle stops automatically and the oven indicates when the dish is cooked. You may start cooking whether the oven has been **preheated** or **not**.

! When the cooking stage has been reached, the oven buzzer sounds.

! Do not open the oven door to avoid offsetting the cooking time and temperature.

ROAST mode

Use this function to cook beef, pork and lamb. Place the meat inside the oven while it is still cold. The dish may also be placed in a preheated oven.

BAKED CAKES mode

This function is ideal for cooking desserts which are made using natural yeast, baking powder and desserts which contain no yeast. Place the dish in the oven while it is still cold. The dish may also be placed in a preheated oven.

PIZZA mode

Use this function to make pizza. Please see the following chapter for the recipe and further details.

BREAD mode

Use this function to make bread. Please see the following chapter for the recipe and further details.

PIZZA mode

To obtain the best results, we recommend that you carefully observe the instructions below:

- Follow the recipe.
- The weight of the dough should be between 500 g and 700 g.
- Lightly grease the dripping pan.

Recipe for PIZZA:

1 dripping pan on a low shelf level, hot or cold oven
 Recipe for 3 pizzas weighing approximately 550 g: 1000 g flour, 500 ml water, 20 g salt, 20 g sugar, 100 ml olive oil, 20 g fresh yeast (or 2 sachets of powder yeast)

- Leavening at room temperature: 1 hour.
- Place inside hot or cold oven.

- Start the  PIZZA cooking mode.

BREAD mode

To obtain the best results, we recommend that you carefully observe the instructions below:

- Follow the recipe.
- Do not exceed the **maximum weight** of the dripping pan.
- **Remember to pour 100 ml of cold water into the baking tray in position 5.**
- The dough must be left to rise at room temperature for 1 – 1 ½ hours (depending on the room temperature) or until the dough has doubled in size.

Recipe for BREAD:

1 Dripping pan holding 1000 g Max, lower level
 2 Dripping pans each holding 1000 g Max, medium and lower levels

Recipe for 1000 g of dough: 600 g flour, 360 g water, 11g salt, 25 g fresh yeast (or 2 sachets of powder yeast)

Method:





- Mix flour and salt in a large bowl.
- Dilute yeast in lukewarm water (approximately 35 degrees).
- Make a small well in the mound of flour.
- Pour in water and yeast mixture.
- Knead dough by stretching and folding it over itself with the palm of your hand for 10 minutes until it has a uniform consistency and is not too sticky.
- Ball and cover the dough with plastic wrap and leave it to leaven at room temperature for 1 – 1 ½ hours (until it has doubled in size).
- Cut the dough into equal sized loaves.
- Place them in the dripping pan on oven paper.
- Cover the loaves with flour.
- Make incisions on the loaves.
- **Remember to pour 100 ml of cold water into the baking tray in position 5.** For cleaning purposes, we recommend the use of water and vinegar.
- Place the loaves inside the oven while it is still cold.
- Start the  BREAD cooking mode.
- Once baked, leave the loaves on one of the grill racks until they have cooled completely.

Programming cooking

! A cooking mode must be selected before programming can take place.





Programming the duration



To set the duration of a manual cooking mode :

1. Press the  button several times until the  icon and the first digit on the TIME display flash.
2. Press the "+" and "-" buttons to adjust the hour value.
3. Press the  button again until the other two digits on the TIME display begin to flash.
4. Press the "+" and "-" buttons to adjust the minute value.
5. Press the  button again to confirm.
 - For example: it is 9:00 a.m. and a time of 1 hour and 15 minutes is programmed. The programme will stop automatically at 10:15 a.m.

Programming delayed cooking

! A cooking duration must be selected before delayed programming can take place.

1. Follow steps 1 to 5 to set the duration as detailed above.
2. Then press the  button until the  icon and the two digits on the TIME display flash.
3. Press the "+" and "-" buttons to adjust the hour value.
4. Press the  button again until the other two digits on the TIME display begin to flash.
5. Press the "+" and "-" buttons to adjust the minute value.
6. Press the  button again to confirm.
 - For example: it is 9:00 a.m. and a time of 1 hour and 15 minutes is programmed and the end time is set to 12:30. The programme will start automatically at 11:15 a.m.

Programming has been set when the  and  buttons are illuminated. The TIME display shows the cooking end time and the cooking duration alternately. To cancel a programmed procedure press the "START/STOP" button.

Practical cooking advice

! Do not place racks in position 1 and 5 during fan-assisted cooking. This is because excessive direct heat can burn temperature sensitive foods.

! In the BARBECUE and GRATIN cooking modes, particularly when using the rotisserie spit, place the dripping pan in position 1 to collect cooking residues (fat and/or grease).

MULTILEVEL

- Use positions 2 and 4, placing the food which requires more heat on 2.
- Place the dripping pan on the bottom and the rack on top.

BARBECUE

- Insert the rack in position 3 or 4. Place the food in the centre of the rack.
- We recommend that the power level is set to maximum. The top heating element is regulated by a thermostat and may not always operate constantly.

PIZZA

- Use a light aluminium pizza pan. Place it on the rack provided.
For a crispy crust, do not use the dripping pan as it prevents the crust from forming by extending the total cooking time.
- If the pizza has a lot of toppings, we recommend adding the mozzarella cheese on top of the pizza halfway through the cooking process.

Cooking advice table

Cooking modes	Foods	Weight (in kg)	Rack position		Preheating	Recommended temperature (°C)	Cooking duration (minutes)
			standard guide rails	sliding guide rails			
Multilevel*	Pizza on 2 racks	1+1	2 and 4	1 and 3	Yes	220-230	20-25
	Pies on two racks/cakes on 2 racks	1	2 and 4	1 and 3	Yes	180	30-35
	Sponge cake on 2 racks (on the dripping pan)	1	2 and 4	1 and 3	Yes	170	20-25
	Roast chicken + potatoes	1	1 and 2/3	1 and 3	Yes	200-210	65-75
	Lamb		2	1	Yes	190-200	45-50
	Mackerel		1 or 2	1	Yes	180	30-35
	Lasagne		2	1	Yes	190-200	35-40
	Cream puffs on 2 racks		2 and 4	1 and 3	Yes	190	20-25
	Biscuits on 2 racks		2 and 4	1 and 3	Yes	190	10-20
	Cheese puffs on 2 racks		2 and 4	1 and 3	Yes	210	20-25
	Savoury pies		1 and 3	1 and 3	Yes	200	20-30
Barbecue*	Mackerel	1	4	3	No	100%	15-20
	Sole and cuttlefish	0.7	4	3	No	100%	10-15
	Squid and prawn kebabs	0.7	4	3	No	100%	8-10
	Cod fillet	0.7	4	3	No	100%	10-15
	Grilled vegetables	0.5	3 or 4	2 or 3	No	100%	15-20
	Veal steak	0.8	4	3	No	100%	15-20
	Sausages	0.7	4	3	No	100%	15-20
	Hamburgers	4 or 5	4	3	No	100%	10-12
	Toasted sandwiches (or toast)	4 or 6	4	3	No	100%	3-5
	Spit-roast chicken using rotisserie spit (where present)	1	-	-	No	100%	70-80
	Spit-roast lamb using rotisserie spit (where present)	1	-	-	No	100%	70-80
Gratin*	Grilled chicken	1.5	2	2	No	210	55-60
	Cuttlefish	1	2	2	No	200	30-35
	Spit-roast chicken using rotisserie spit (where present)	1.5	-	-	No	210	70-80
	Spit-roast duck using rotisserie spit (where present)	1.5	-	-	No	210	60-70
	Roast veal or beef	1	2	2	No	210	60-75
	Roast pork	1	2	2	No	210	70-80
	Lamb	1	2	2	No	210	40-45
Low temperature	Defrosting		2 or 3	2	No	-	-
	Proving		2 or 3	2	No	-	60-90
	Dish heating		2 or 3	2	No	-	-
	Pasteurisation		2 or 3	2	No	-	-
Automatic pizza	Pizza (see recipe)	1	2	2	No	-	23-33
	Focaccia (bread dough)	1	2	2	No	-	23-33
Automatic bread	Bread (see recipe)	1	2	2	No	-	55
Automatic baked cakes	Cakes made using leavened dough	1	2 or 3	2	No	-	35-55
Automatic roast	Roasts	1	2 or 3	2	No	-	60-80

* The cooking times listed above are intended as guidelines only and may be modified according to personal tastes. Oven preheating times are set as standard and may not be modified manually.

Precautions and tips

GB

! This appliance has been designed and manufactured in compliance with international safety standards. The following warnings are provided for safety reasons and must be read carefully.

General safety

- The appliance was designed for domestic use inside the home and is not intended for commercial or industrial use.
- The appliance must not be installed outdoors, even in covered areas. It is extremely dangerous to leave the appliance exposed to rain and storms.
- When moving or positioning the appliance, always use the handles provided on the sides of the oven.
- Do not touch the appliance with bare feet or with wet or damp hands and feet.
- The appliance must be used by adults only for the preparation of food, in accordance with the instructions provided in this booklet.
- **Do not touch the heating elements and parts of the oven door when the appliance is in use; these parts become extremely hot. Keep children well away from the appliance.**
- Ensure that the power supply cables of other electrical appliances do not come into contact with the hot parts of the oven.
- The openings used for the ventilation and dispersion of heat must never be covered.
- Always grip the oven door handle in the centre: the ends may be hot.
- Always use oven gloves when placing cookware in the oven or when removing it.
- Do not use aluminium foil to line the bottom of the oven.
- Do not place flammable materials in the oven: If the appliance is switched on accidentally, it could catch fire.
- When unplugging the appliance, always pull the plug from the mains socket; do not pull on the cable.
- Never perform any cleaning or maintenance work without having disconnected the appliance from the electricity mains.

- If the appliance breaks down, under no circumstances should you attempt to perform the repairs yourself. Repairs carried out by inexperienced persons may cause injury or further malfunctioning of the appliance. Contact a Service Centre (*see Assistance*).

- Do not rest heavy objects on the open oven door.

Disposal

- When disposing of packaging material: observe local legislation so that the packaging may be reused.
- The European Directive 2002/96/EC relating to Waste Electrical and Electronic Equipment (WEEE) states that household appliances should not be disposed of using the normal solid urban waste cycle. Exhausted appliances should be collected separately in order to optimise the cost of re-using and recycling the materials inside the machine, while preventing potential damage to the atmosphere and to public health. The crossed-out dustbin is marked on all products to remind the owner of their obligations regarding separated waste collection. For further information relating to the correct disposal of exhausted household appliances, owners may contact the public service provided or their local dealer.

Respecting and conserving the environment

- You can help to reduce the peak load of the electricity supply network companies by using the oven in the hours between late afternoon and the early hours of the morning. The cooking mode programming options, the “delayed cooking” mode (*see Cooking modes*) and “delayed automatic cleaning” mode (*see Care and Maintenance*) in particular, enable the user to organise their time efficiently.
- Always keep the oven door closed when using the BARBECUE and GRATIN modes: This will achieve improved results while saving energy (approximately 10%).
- Check the door seals regularly and wipe them clean to ensure they are free of debris so that they adhere properly to the door, thus avoiding heat dispersion.

Switching the appliance off

Disconnect your appliance from the electricity supply before carrying out any work on it.

Cleaning the appliance

- The stainless-steel or enamel-coated external parts and the rubber seals may be cleaned using a sponge that has been soaked in lukewarm water and neutral soap. Use specialised products for the removal of stubborn stains. After cleaning, rinse and dry thoroughly. Do not use abrasive powders or corrosive substances.
- The inside of the oven should ideally be cleaned after each use, while it is still lukewarm. Use hot water and detergent, then rinse well and dry with a soft cloth. Do not use abrasive products.
- All accessories - with the exception of the sliding racks - can be washed like everyday crockery, and are even dishwasher safe.
- We recommend that detergents are not sprayed directly onto the control panel, but that a sponge is used instead.

! Never use steam cleaners or pressure cleaners on the appliance.

Inspecting the seals

Check the door seals around the oven regularly. If the seals are damaged, please contact your nearest After-sales Service Centre (*see Assistance*). We recommend that the oven is not used until the seals have been replaced.

Cleaning the oven door*

Clean the glass part of the oven door using a sponge and a non-abrasive cleaning product, then dry thoroughly with a soft cloth. Do not use rough abrasive material or sharp metal scrapers as these could scratch the surface and cause the glass to crack.

For more thorough cleaning purposes, the external glass panel on the oven door may be removed:

1. loosen the two screws V (*see figure*);
2. remove the glass panel by unhooking it from the handle (*see figure*);

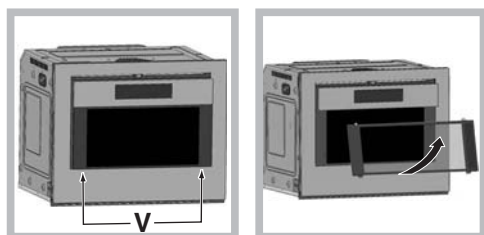

Replace the glass panel by following the above sequence in reverse.

Replacing the light bulb

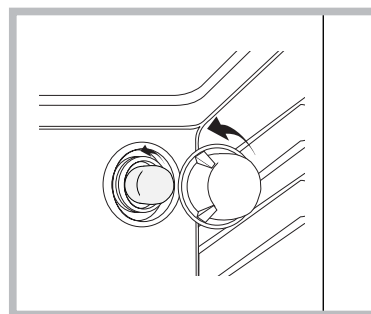

To replace the oven light bulb:

1. Remove the glass cover using a screwdriver.
 2. Remove the light bulb and replace it with a similar one: Wattage 15 W, cap E 14.
- Replace the glass cover, making sure the seal is positioned correctly (*see diagram*).

* Only available on certain models.

Sliding rack kit assembly

To assemble the sliding racks:

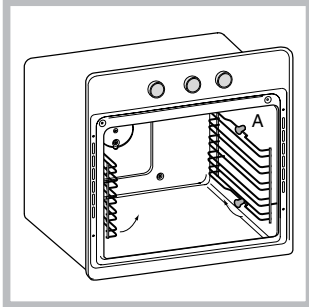

1. Remove the two frames, lifting them away from the spacers A (*see figure*).

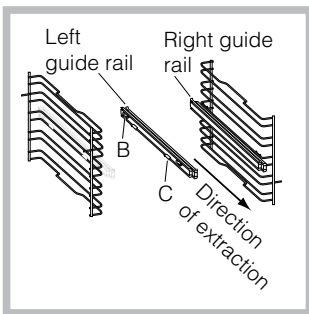

2. Choose which shelf to use with the sliding rack. Paying attention to the direction in which the sliding rack is to be extracted, position joint B and then joint C on the frame.

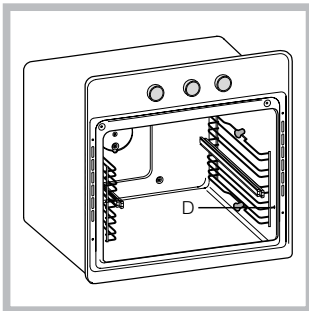

3. Secure the two frames with the guide rails using the holes provided on the oven walls (*see diagram*). The holes for the left frame are situated at the top, while the holes for the right frame are at the bottom.

4. Finally, fit the frames on the spacers A.

! Do not place the sliding racks in position 5.

Assistance

Warning:

The appliance is fitted with an automatic diagnostic system which detects any malfunctions. Malfunctions are displayed by messages of the following type: "ER" followed by numbers. Call for technical assistance if a malfunction occurs.

Before calling for Assistance:

- Check whether you can fix the problem yourself.
- Restart the programme to check whether the malfunction has disappeared.
- If it has not, contact the Authorised Technical Assistance Service.

! Never use the services of an unauthorised technician.

Please have the following information to hand:

- The message shown on the TEMPERATURE display.
- The appliance model (Mod.).
- The serial number (S/N).

The latter two pieces of information can be found on the data plate located on the appliance.

After Sales Service

GB

No one is better placed to care for your Hotpoint appliance during the course of its working life than us - the manufacturer.

Essential Contact Information

Hotpoint Service

We are the largest service team in Europe offering you access to 400 skilled telephone advisors and 1100 fully qualified engineers on call to ensure you receive fast, reliable, local service.

UK: 08709 066 066
Republic of Ireland: 0818 313 413
www.hotpointservice.co.uk

Please note: Our advisors will require the following information:

Model number:

Serial number:

Parts and Accessories

We supply a full range of genuine replacement parts as well as accessory products that protect and hygienically clean your appliance to keep it looking good and functioning efficiently throughout its life.

UK: 08709 077 077
Republic of Ireland: 0818 313 413
www.hotpointservice.co.uk

Appliance Registration

We want to give you additional benefits of Hotpoint ownership. To activate your free 5 year parts guarantee you must register your appliance with us.

UK: 0870 6092094
Republic of Ireland: 01 230 0800
www.hotpointservice.co.uk

Indesit Company UK Ltd. Morley Way, Peterborough, PE2 9JB
Indesit Company Unit 49 Airways Industrial Estate, Dublin 17



Recycling & Disposal Information

As part of Hotpoint's continued commitment to helping the environment, Hotpoint reserves the right to use quality, recycled components to keep down customer costs and minimise material wastage.

Please dispose of packaging and old appliances carefully. To minimise the risk of injury to children, remove the door, plug and cut the mains cable off flush with the appliance. Dispose of these parts separately to ensure that the appliance can no longer be plugged into a mains socket, and the door cannot be locked shut.

Guarantee

12 Months Parts and Labour Guarantee

Your appliance has the benefit of our manufacturer's guarantee, which covers the cost of breakdown repairs for twelve months from the date of purchase.

This gives you the reassurance that if, within that time, your appliance is proven to be defective because of either workmanship or materials, we will, at our discretion, either repair or replace the appliance at no cost to you.

This guarantee is subject to the following conditions:

- The appliance has been installed and operated correctly and in accordance with our operating and maintenance instructions.
- The appliance is used only on the electricity or gas supply printed on the rating plate.
- The appliance has been used for normal domestic purposes only.
- The appliance has not been altered, serviced, maintained, dismantled, or otherwise interfered with by any person not authorised by us.
- Any repair work must be undertaken by us or our appointed agent.
- Any parts removed during repair work or any appliance that is replaced become our property.
- The appliance is used in the United Kingdom or Republic of Ireland.

The guarantee **does not cover**:

- Damage resulting from transportation, improper use, neglect or interference or as a result of improper installation.
- Replacement of any consumable item or accessory . These include but are not limited to: plugs, cables, batteries, light bulbs, fluorescent tubes and starters, covers and filters.
- Replacement of any removable parts made of glass or plastic.

THIS GUARANTEE WILL NOT APPLY IF THE APPLIANCE HAS BEEN USED IN COMMERCIAL OR NON-DOMESTIC PREMISES.

5 Year Parts Guarantee

Hotpoint also offers you a free 5 year parts guarantee. This additional guarantee is conditional on you registering your appliance with us and the parts being fitted by one of our authorised engineers. There will be a charge for our engineer's time. To activate the extra parts warranty on your appliance, simply call our registration line on **0870 6092094 (ROI 01 230 0800)**.

Extended Guarantees

We offer a selection of repair protection plans that enable you to fully cover yourself against the expense of repair bills for the life of your policy. To find the ideal plan for you please call our advice line on **08709 088 088 (ROI 01 230 0233)**.

Free Helpdesk Service

We have a dedicated team who can provide free advice and assistance with your appliance if you experience any technical difficulties within the first 90 days of ownership. Simply call our Hotpoint Service Hotline on **08709 066 066 (ROI 0818 313 413)** for telephone assistance, or, where necessary, to arrange for an engineer to call. If we cannot resolve the technical problem we will replace your machine or, if you prefer, give you your money back.

Free Manuals Download Website

<http://myh66.com>

<http://usermanuals.us>

<http://www.somanuals.com>

<http://www.4manuals.cc>

<http://www.manual-lib.com>

<http://www.404manual.com>

<http://www.luxmanual.com>

<http://aubethermostatmanual.com>

Golf course search by state

<http://golfingnear.com>

Email search by domain

<http://emailbydomain.com>

Auto manuals search

<http://auto.somanuals.com>

TV manuals search

<http://tv.somanuals.com>