



Instructions for Installation and Use
UD47
UT47

To the Installer

Before installation fill in the product details on the back cover of this booklet. The information can be found on the rating plate.

To the User

You must read the instructions prior to installing and using the appliance and then retain them for future reference.

PLEASE READ THIS BOOKLET CAREFULLY.

Contents	Page
Introduction	3
Safety Information - Always	4
Never	5
The main parts of your Double Oven	6
Controls	7
Oven Timer Operation	8-13
Using the Top Oven for Grilling	14
Grill Pan and Handle	15
Operation when using Top Oven for Grilling	16
Guide for Grilling	17
Using the Top Oven as a Convection Oven	18
Operation when using the Top Oven as a Convection Oven	19
Using the Main Oven for Fan Cooking	20
Using the Main Oven for other Functions	21-22
Temperature Conversion Chart	23
Cooking Temperature Charts	24-25
Cooking Results not Satisfactory	26
Care and Cleaning	27-30
Installation Instructions	31-34
If Something Goes Wrong	35
Hotpoint Service Cover	36
Key Contacts	Back Cover

Retention of this Instruction Book

This Instruction Book must be kept handy for reference as it contains important details on the safe and proper use of the appliance.

If you sell or pass the appliance to someone else, or move house and leave it behind, make sure this Book is also provided so the new owner can become familiar with the appliance and safety warnings.

If the Book is lost or damaged a copy may be obtained from:

General Domestic Appliances Ltd, Morley Way, Peterborough, PE2 9JB.

Introduction

Your new appliance is guaranteed* and will give lasting service. This guarantee is only applicable if the appliance has been installed in accordance with the installation instructions detailed in this booklet.

To help make best use of your cooking equipment, please read this booklet carefully.

The appliance is designed specifically for domestic use and responsibility will not be accepted for use in any other installation.

When the cooker is first used an odour may be emitted, this will cease after a period of use

To help remove the 'new' smell, heat up the empty ovens to maximum temperature for a minimum of two or three hours, keeping the oven doors closed. Ensure that the room is well ventilated (e.g. open a window or use an extractor fan) and that persons who may be sensitive to the odour avoid any fumes.

It is suggested that any pets be removed from the room until the smell has ceased. This odour is due to temporary finish on oven liners and elements and also any moisture absorbed by the insulation.

*** The guarantee is subject to the provisions that the appliance:**

- (a) Has been used solely in accordance with the Users Instruction Book.**
- (b) Has been properly connected to a suitable supply voltage as stated on the rating plate attached to this equipment.**
- (c) Has not been subjected to misuse or accident or been modified or repaired by any person other than the authorised employee or agent.**
- (d) Has been correctly installed.**

Disposal of your product

To minimise the risk of injury to children please dispose of your product carefully and safely. Remove all doors and lids. Remove the mains cable (where fitted) by cutting off flush with the appliance and always ensure that no plug is left in a condition where it could be connected to the electricity supply.

To help the environment, Local Authority instructions should be followed for the disposal of you product.

This appliance conforms to the following EEC Directives:

Electromagnetic Compatibility	Low Voltage Equipment
89/336/EEC	73/23/EEC
92/31/EEC	93/68/EEC
93/68/EEC	



Safety Information

**When used properly your appliance is completely safe but as with any electrical product there are certain precautions that must be observed.
PLEASE READ THE PRECAUTIONS BELOW BEFORE USING YOUR APPLIANCE.**

Always

- Always make sure you remove all packaging and literature from inside the oven and grill compartments before switching on for the first time.
- Always make sure you understand the controls prior to using the appliance.
- Always keep children away from the appliance when in use as the surfaces will get extremely hot during and after cooking.
- Always make sure all controls are turned off when you have finished cooking and when not in use.
- Always stand back when opening an oven door to allow any build up of steam or heat to disperse.
- Always use dry, good quality oven gloves when removing items from the oven/grill.
- Always take care to avoid heat/steam burns when operating the controls.
- Always turn off the electricity supply at the wall switch before cleaning and allow the appliance to cool.
- Always make sure the shelves are in the correct position before switching on the oven.
- Always keep the oven and grill doors closed when the appliance is not in use.
- Always take care when removing utensils from the top oven when the main oven is in use as the contents may be hot.
- Always keep the appliance clean as a build up of grease or fat from cooking can cause a fire.
- Always follow the basic principles of food handling and hygiene to prevent the possibility of bacterial growth.
- Always keep ventilation slots clear of obstructions.
- Always refer servicing to a qualified appliance service engineer.
- During use the oven becomes hot. Care should be taken to avoid touching heating elements inside the oven,

SAFETY ADVICE

IN THE EVENT OF A CHIP PAN OR ANY OTHER PAN FIRE:

1. TURN OFF THE COOKER APPLIANCE AT THE WALL SWITCH.
2. COVER THE PAN WITH A FIRE BLANKET OR DAMP CLOTH, this will smother the flames and extinguish the fire.
3. LEAVE THE PAN TO COOL FOR AT LEAST 60 MINUTES BEFORE MOVING IT. Injuries are often caused by picking up a hot pan and rushing outside with it. NEVER USE A FIRE EXTINGUISHER TO PUT OUT A PAN FIRE as the force of the extinguisher is likely to tip the pan over. Never use water to extinguish oil or fat fires.

Safety Information

Never

- Never leave children unsupervised where a cooking appliance is installed as all cooking surfaces will be hot during and after use.
- Never allow anyone to sit or stand on any part of the appliance.
- Never store items above the appliance that children may attempt to reach.
- Never remove the oven shelves whilst the oven is hot.
- Never heat up unopened food containers as pressure can build up causing the container to burst.
- Never store chemicals, food stuffs or pressurised containers in or on the appliance, or in cabinets immediately above or next to the appliance.
- Never operate the grill with the door closed as this will cause the appliance to overheat.
- Never use the appliance as a room heater.
- Never use the grill to warm plates.
- Never dry any items on the oven doors.
- Never install the appliance next to curtains or other soft furnishings.
- Never allow children to play with the appliance controls.
- Never use 'steam cleaners'.

The main parts of your Double Oven

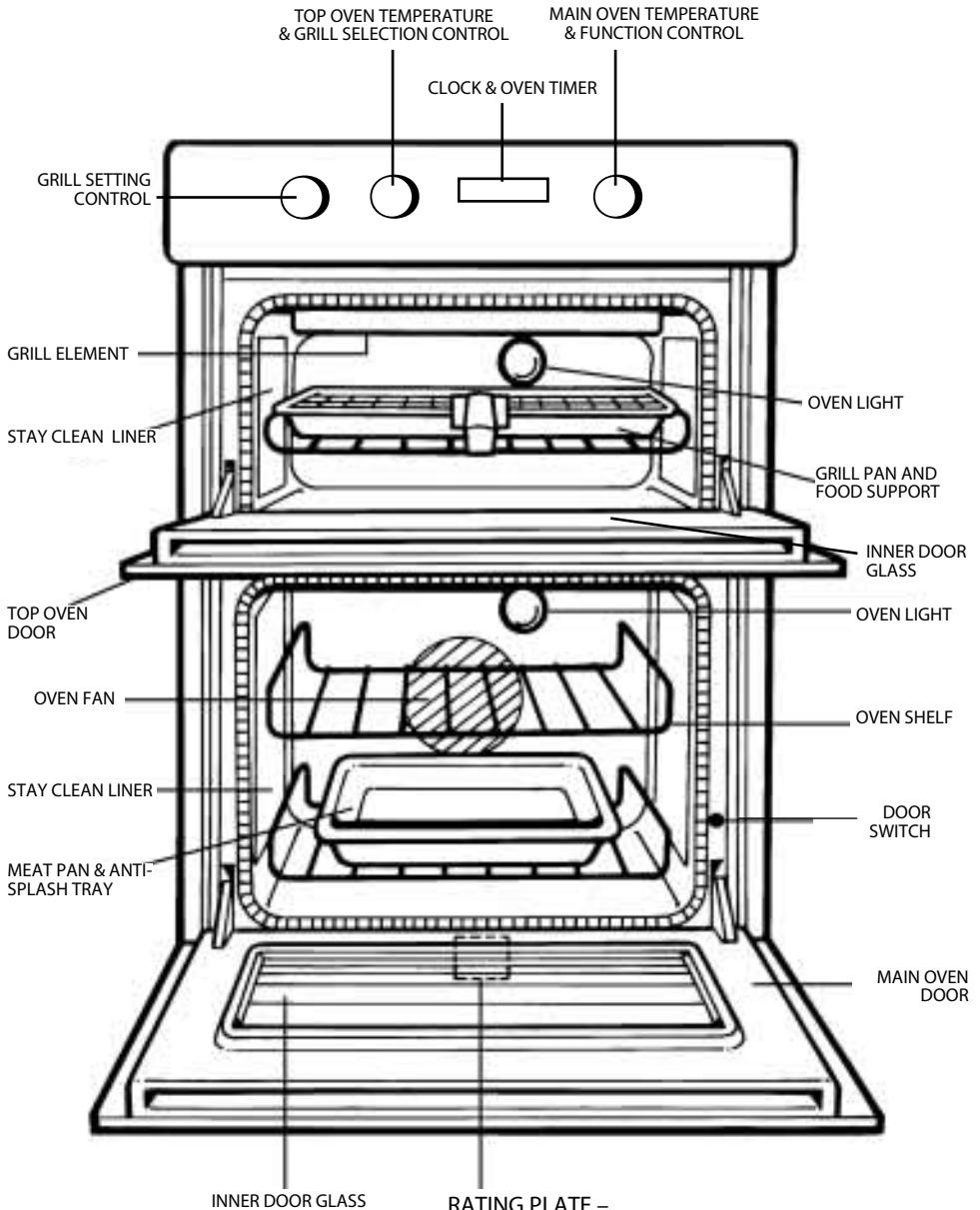



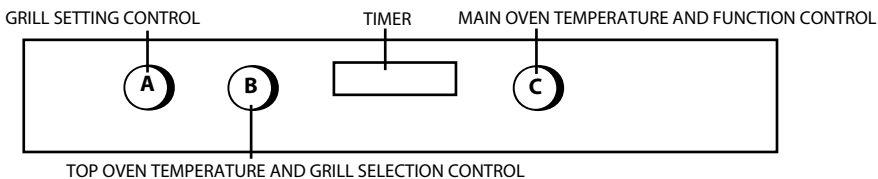

RATING PLATE – Record the Model No. and the Serial No. on KEY CONTACTS, back page.

Controls



CONTROL MARKINGS

Control Knob	Description	Function
A	Grill Setting Control	<p>Selects the heat at which the grill will cook the food.</p> <p>Grill Settings Control: MIN - MAX</p> <p>Note: To grill you must first select a grill function using control (B).</p>
B	Top Oven Temperature & Grill Selection Control	<p>100 - MAX Selects the cooking temperature (Degrees Centigrade) when using the top oven as a conventional oven.</p> <p> Switches the top oven to "Half Grill" mode.</p> <p> Switches the top oven to "Full Grill" mode.</p>
C	Main Oven Temperature & Function Control	<p> Fan Only Setting - This is used to decrease the amount of time required to defrost food items.</p> <p> Oven Light Only - Switches on the Main Oven Interior Light Only.</p> <p>80 - MAX Main Oven Temperature Scale (In Degrees Centigrade). - When cooking select the required cooking temperature.</p>

Cooling Fan:

A gentle flow of air will be blown below the control panel when any selector switch is used.

Note:

Whenever the appliance has been used, the cooling fan may run on or restart itself after all the controls have been turned off. This indicates that the appliance is still warm.

Oven Interior Lights

The oven lights are operated when their respective oven control is used. (N.B. Not all models have a top oven interior light). The main oven has a light only position.

Slow Cooking

The main oven has a "Slow Cook Setting" this can be used for slow cooking, keeping food warm and warming plates for a short period.

Element and Fan Cut Off

The oven is fitted with a safety device which disconnects the heating element and oven fan when the door is opened. The heating element and oven fan will not operate until the oven door is closed.

Note: It is advisable to check that all oven controls have been switched off when you have finished using the appliance.

Oven Timer Operation

Note: Timer must be set to 'Time of Day' and 'Manual' before the ovens can be used.

AUTOMATIC COOKING

The Top Oven and Main Oven can be controlled by the automatic timer. When the timer control has been set for one oven, it is possible to use the other oven only during the same automatic cooking programme.

NEVER operate the grill when the ovens are set to cook automatically because the oven cavity can become warm and this may cause bacterial growth in food.

HINTS ON AUTOMATIC COOKING

1. Select foods which will require the same cooking time and temperature.
2. To ensure food does not cool down and require reheating, set the end time so the food is ready when you require it.
3. Always ensure that meat and poultry is defrosted before placing in the oven.
4. Whenever possible, take food out of the refrigerator and keep it as cool as possible.
5. If cooking food that requires frying before placing in the oven for auto cooking, keep the delay start time to a minimum.
6. Never place hot or warm food in the oven for delay start cooking as it could cause the oven to be warm and produce harmful bacteria in the food.
7. We advise that dishes containing left-over cooked poultry or meat, e.g. Shepherd's Pie, should not be cooked automatically if there is to be a delay period.
8. Ensure that delay start times are kept to a minimum to prevent bacterial growth in food.
9. Wine or beer may ferment and cream may curdle during the delay period so it is best to add these ingredients just before serving.
10. Foods which discolour should be protected by coating in fat or tossing in water to which lemon juice has been added, prior to placing food in the oven.
11. Dishes containing liquid should not be filled too full to prevent boiling over.
12. Food should be well sealed (but not airtight) in a container to prevent the loss of liquid during cooking. Aluminium foil gives a good seal.
13. Always ensure that food is piping hot and cooked thoroughly before serving.
14. Only reheat food once.

Know Your Timer

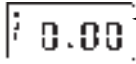

CLOCKFACE
The timer incorporates a 24 hour clock.
Ensure the correct time of day is always set, before using your cooker.

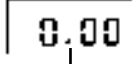

SYMBOLS
A 'bell' symbol will light up when you select a Minute Minder Period and will remain lit for the period set.
At the end of the Minute Minder Period, the timer will emit an audible tone and the 'bell' symbol will disappear.

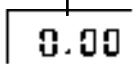

The 'cookpot' symbol will light up either:-
- When the timer is in manual mode, or
- During the actual Cook Period.

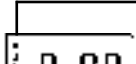



'AUTO' will light up:-
- When the timer is first turned on it will flash. It will go out when a time of day is set or when the timer is set to manual.
The 'AUTO' symbol will flash at the end of an Auto Cooking programme to indicate that the programme has finished.
(When the 'AUTO' symbol is flashing, to return the oven to Manual operation, turn the oven controls off, ensure that the correct time of day is set, and press the "Manual" button - The 'AUTO' symbol will go out).

TIMER FUNCTION BUTTONS

 **Minute Minder Button** Here you can set a time period of up to 23 hours 59 minutes, that will count down. When it reaches zero, the timer will emit an audible tone.
For Example: If you set 20 minutes, the audible tone will occur 20 minutes later.

AUTO COOKING PROGRAMME

 **Cook Period Button** Cook Period is the actual length of time for which, the timer will switch the oven(s) on as part of an "Auto Cooking" programme.
(e.g. If you set 2 hours, the food will be cooked for 2 hours).

 **End Time Button** The time of day at which you want an "Auto Cooking" programme to **end**.
For Example: If you set a "Cook Period" for 2 hours, and "End Time" of 11:00. The timer will switch the oven(s) on at 9:00 and turn the oven(s) off at 11:00. You will hear an audible tone at 11:00, to indicate that the Auto Cooking Programme has finished.

Notes:

- When setting an Auto Cooking programme you will need to set the oven control(s) to the required temperature(s) when you set the timer.
- If an Auto Cooking programme has been set the oven(s) will only operate during the pre-programmed time.

 **Manual Button** Needs to be pressed to cancel an Auto Cooking programme and return the oven(s) to Manual operation.

"+/-" knob Use to adjust the various timer function settings.

Electronic Clock & Automatic Oven Timer Operation

SETTING THE TIME OF DAY

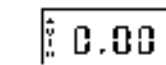

Step 1 Make sure all oven controls are turned Off.

Step 2 Check the electricity supply to the cooker is turned on.

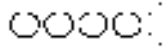

Step 3 When switched on the display will show 0.00 and the Auto symbol, flashing intermittently.



Step 4 Press & hold in both the Cook Period & End Time buttons together.

Step 5 With the Cook Period & End Time buttons still held in, turn the "+/-" knob to set the correct time of day.



Step 6 Release all the buttons simultaneously.

THE TIME OF DAY IS NOW SET.

To change the time of day repeat Steps 4, 5 & 6 above.

Note: You cannot adjust the time of day if the timer has been set for an Auto Cooking Programme.

SETTING THE MINUTE MINDER

Step 1 Ensure the time of day is set correctly.

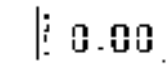

Step 2 Press and hold the Minute Minder button.

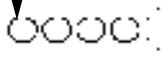

Step 3 With the Minute Minder button held in, set the required Minute Minder period using the "+/-" knob. A 'bell' symbol will light up.

Release all buttons and the timer display will revert back to the time of day. The 'bell' symbol will remain lit to signify that a Minute Minder period has been set.



At the end of the set time an audible tone will be heard, and the 'bell' symbol will disappear.

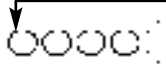

Step 4 To cancel the audible tone press the Minute Minder button.

Note 1 When the Minute Minder has been set, the time remaining can be checked at any time by simply pressing the Minute Minder button.

Note 2 If necessary the Minute Minder can be cancelled before the tone sounds by pressing and holding the Minute Minder button and then at the same time turning the "+/-" knob to the "-" position until 0.00 appears in the display window.

Electronic Clock & Automatic Oven Timer Operation

AUTO COOKING PROGRAMMES

There are two Auto Cooking programmes that can be selected using your timer:-

- (a) To set the timer to switch the oven(s) On and Off Automatically
- (b) To set timer to switch on immediately and OFF automatically after a set cook period.

a) TO SET THE TIMER TO SWITCH THE OVEN(S) ON AND OFF AUTOMATICALLY

This allows you to cook at a specified time for a chosen period before the oven switches off Automatically.

Step 1 Check that the correct time of day is set, if not follow instructions for setting the time of day.

Step 2 Place food onto the correct shelf position in the oven and close the oven door(s).

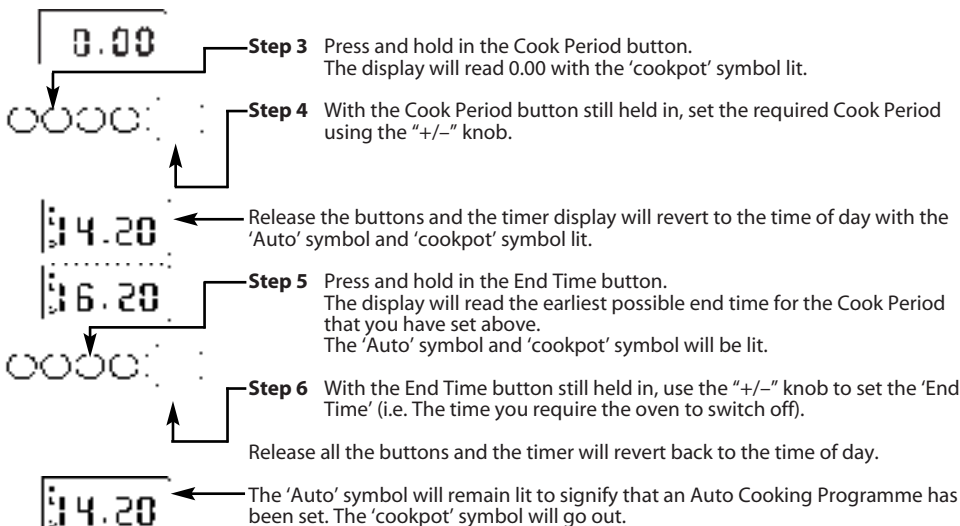

Step 7 Turn the oven control(s) to the required temperature, and if necessary select the appropriate oven function.

Note: If your appliance has two ovens: When the timer has been set for one oven it is possible to use the other oven only during the same Automatic programme.

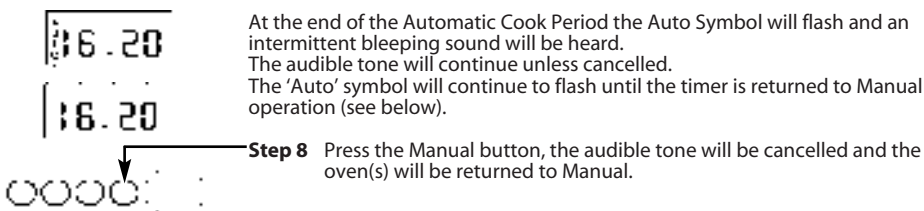

Step 9 Turn the oven control(s) to the OFF position.

Electronic Clock & Automatic Oven Timer Operation

Note 1 When cooking automatically the Cook Period can be checked at any time by simply pressing the Cook Period button.

Note 2 When cooking automatically the End Time can be checked at any time by simply pressing the End Time button.

b) TO SET TIMER TO SWITCH ON IMMEDIATELY AND OFF AUTOMATICALLY AFTER A SET COOK PERIOD

- Step 1** Check that the correct time of day is set, if not follow instructions for setting the time of day.
Step 2 Place food onto the correct shelf position in the oven and close the oven door(s).
Step 3 Turn the oven control(s) to the required temperature, and if necessary select the appropriate oven function.

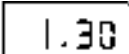
 **Step 4** Press & hold in the Cook Period button, the display will read 0.00 and the 'cookpot' symbol will light up.

 With the Cook Period button still held in set the required Cook Period using the "+/-" knob. Example: 1hr 30 minutes (as shown).

Note: Cook Period is the length of time the food requires to cook.

Step 5 Release all buttons.

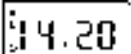

 The timer display will revert to the time of day with the 'Auto' symbol lit & 'cookpot' symbol remaining lit.

NOTE: The Cookpot symbol disappears

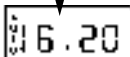
At the end of the Cook Period the 'Auto' symbol will flash and an intermittent audible tone will be heard. The audible tone will continue until cancelled. The 'Auto' symbol will continue to flash until the timer is returned to Manual operation (see below).

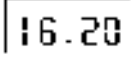

Step 6 Press the Manual button. The audible tone will be cancelled and the oven(s) will be returned to Manual.





Step 7 Turn the oven control(s) to the OFF position.

Electronic Clock & Automatic Oven Timer Operation

TO CANCEL AN AUTO COOKING PROGRAMME BEFORE THE COOK PERIOD HAS FINISHED.

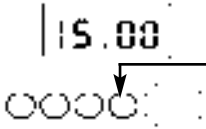
Step 1 Turn the oven control(s) to the OFF position.



Step 2 Press the Manual button to return the oven(s) to "Manual" operation. The 'Auto' symbol will go out.

Note 1 When cooking automatically the Cook Period can be checked at any time by simply pressing the Cook Period button.

OTHER NOTES ON TIMER OPERATION

1. When cooking Automatically the Cook Period can be checked at any time simply by pressing the Cook Period button.
2. When cooking Automatically the End Time can be checked at any time by simply pressing the End Time button.
3. Having set a Cook Period and End Time an electronic device stores the information. The device within the timer will switch the oven(s) on and off at the required times.
4. When setting an Auto Cooking Programme and a mistake is made, to clear:-
 - (d) Press & release the Manual button.
 - (e) Start the sequence again.
5. If at any time the display shows three flashing zero's 0.00 and 'Auto', it is likely that the electricity supply to the oven has been interrupted. Reset the timer to the correct time of day.
Food in the oven may, therefore, not have been cooked, before serving check food is thoroughly heated and completely cooked.
6. To set each function always press and hold the required function button and at the same time turn the "+/-" knob.

Using the Top Oven for Grilling

Top Oven Shelf Positioning for Grilling

The shelf can be inserted in two different ways for grilling. The grilling chart will indicate the correct orientation.



Orientation A

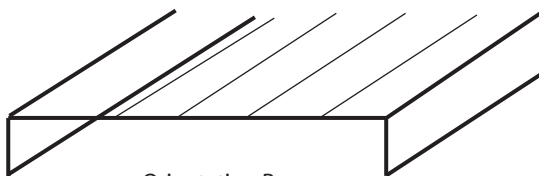

Orientation B

Note

There should always be at least 25mm (1 inch) between the top of the food and the grill element.

Grill Pan and Handle

The grill pan handle is detachable from the pan, to facilitate cleaning and storage.
The grill pan handle can be fixed as follows:

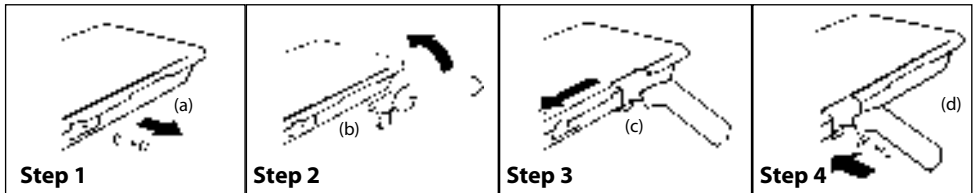

- Step 1** Remove the screw and washers from the grill pan bracket (a).
Step 2 Tilt the handle over the recess (b).
Step 3 Slide it towards the centre of the pan (c).
Step 4 Locate the handle over the bracket (d).
For a fixed handle, replace the screw and washers and ensure they are fully tightened up. If a detachable handle is required, do not replace the screw and washers.

Note: If a fixed handle is required, the grill pan cannot be kept in the main oven with the door closed but may be stored in the top oven with the door closed, when the top oven is not in use..

Grill Pan and Food Support

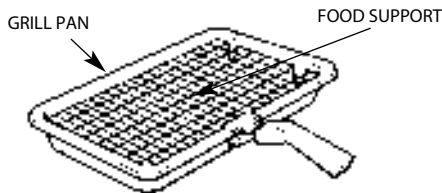

Top Oven Shelf Positioning for Grilling

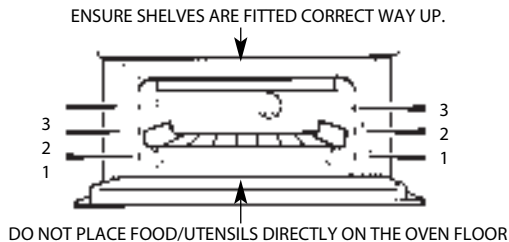

NOTE: Preheat the grill if indicated on grill chart.
The grill pan must be placed on the correct shelf and positioned centrally under the grill element.
Leave the control at MAX for toast, and for fast cooking of foods.
For thicker foods requiring longer cooking, turn the switch to a lower setting after the initial sealing on both sides at MAX. The thicker the food, the lower the control should be set.
DO NOT line the grill pan with aluminium foil, as this increases the amount of fat spitting which can cause a fire.
After use always return both controls to their OFF (0) position.

Operation when using the Top Oven for Grilling

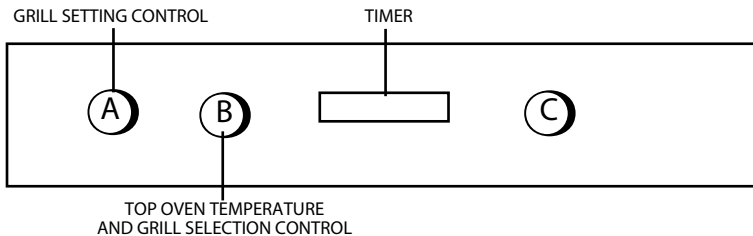

Step 1 Ensure oven timer is set to manual.
Place the shelf in the correct position (see Grilling Guide).
Place the food/grill pan on the shelf, positioned centrally under the grill element.
Leave the top oven door fully open.

Step 2 Turn knob (B) clockwise to select grill function setting:

Set to:  For Half Grill (Left hand side only).
 For Full Grill.

NOTE: As you turn past the end of the oven temperature scale you will feel resistance on the knob – continue turning clockwise until the grill setting position is selected.

Step 3 Turn knob (A) clockwise to select the Grill Setting (MIN - MAX).

Grill Controls Example:

 = Full Grill Function

 = High Grill Setting

NOTE: Do not grill with the grill/top oven door closed.

Step 4 After use, turn both controls A & B anti clockwise to their off (0) position.

DOOR POSITION FOR GRILLING.

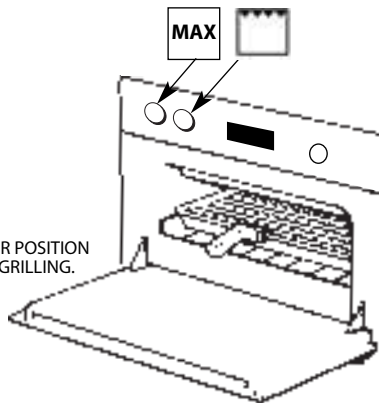

DO NOT allow young children near to the appliance when the grill is in use as the surfaces get extremely hot.

Guide to Grilling

FOOD	PREHEAT FOR 5 MINUTES	SHELF POSITION FROM THE BASE OF THE OVEN	SETTING	APPROXIMATE COOKING TIME	PAN TO BE USED
Toasting of Bread Products	Setting MAX	2B	Setting MAX	5 - 10 minutes	Grill pan and food support
Small cuts of meat, Sausage, Bacon	Setting MAX	2A	MAX for 4 minutes then reduce to LOWER setting	10 - 25 minutes	Grill pan and food support
Chops etc. Gammon steaks	Setting MAX	2A	MAX for 6-8 minutes then reduce to LOWER setting	20 - 35 minutes	Grill pan and food support
Fish: Whole Fillets Fingers	Setting MAX	2B	Setting MAX	8 - 12 minutes 10 - 15 minutes 10 - 20 minutes	Grill pan and food support
Pre-cooked potato products	Setting MAX	2B	Set between MEDIUM and MAX positions	15 - 20 minutes	Grill pan and food support
Pizzas	Setting MAX	2B	Set between MEDIUM and MAX positions	10 - 20 minutes	Grill pan and food support
Browning of food eg. Cauliflower Cheese	Setting MAX	1A	Setting MAX	10 - 20 minutes	Dish placed directly on the shelf

Using the Top Oven as a Convection Oven

The top oven should be used to cook small quantities of food. The oven is designed so that the grill element operates at a reduced heat output, this is combined with a heating element situated underneath the floor of the oven. To ensure even cooking of the food it is important that cooking utensils are positioned correctly on the oven shelf so that the element is directly above. As a guide, the front of the utensil should be approx.100mm (4") from the front of the shelf.

Note: Charts are a guide only, to suit personal taste and requirements, it may be necessary to increase or decrease temperatures by 10°C. It may also be necessary to increase or decrease cooking times.

SHELF POSITIONING

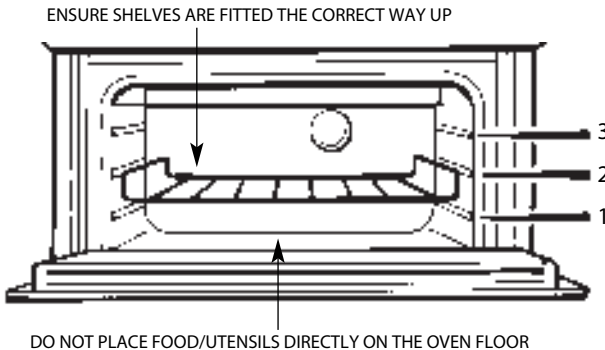

There should always be at least 25mm (1 inch) between the top of the food and the grill element.

WARNING: Items stored in the top oven will get hot when the main oven is in use.

DO NOT allow young children near to the appliance when the top oven is in use as the surfaces get extremely hot.

Operation when using the Top Oven as a Convection Oven

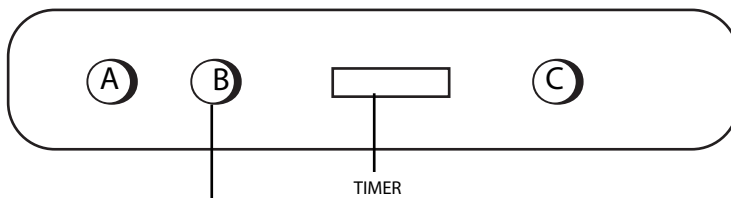

TOP OVEN TEMPERATURE & GRILL SELECTION CONTROL

- Step 1** Check that the timer is in manual.
- Step 2** Place the shelf in the correct position (see Oven Temperature Charts).
- Step 3** Select the required cooking temperature (100°C - MAX) using control (B) (see Top Oven Temperature Charts).
The pilot light (●) will immediately come on, and remain on until the oven reaches the required temperature. The light will then automatically go off and on during cooking as the oven thermostat maintains the correct temperature.
- Step 4** Place the food on the shelf directly below the element ensuring the oven door is closed.

NOTE: At the end of your cooking, always return control (B) to the OFF (O) position.

PLATE WARMING

Place the plates/dishes on shelf position 1 from the base of the top oven, and turn top oven temperature and grill selection control (B) to 100°C for 10-15 minutes.

Never use the grill setting control (A) when warming plates.

TOP OVEN UTENSILS

Do Not use: Meat Pans and Baking Trays larger than – 225mm x 300mm (9"x12")

DO NOT use the grill pan or main oven meat pan as a meat pan in the top oven, as the air circulation will be seriously restricted.

Using the Main Oven for Fan Cooking

Since a circulaire fan oven heats up more quickly and generally cooks food at a lower temperature than a conventional oven, pre-heating is often unnecessary. For guides on “pre-heating”, “cooking temperatures” and “cooking times” see “Oven Temperature Charts” later in book.

Note: Charts are a guide only, to suit personal taste and requirements, it may be necessary to increase or decrease temperatures by 10°C. It may also be necessary to increase or decrease cooking times.

MAIN OVEN SHELF POSITIONING FOR FAN OVEN

Most foods will cook satisfactorily on any shelf position, due to even distribution of heat in the main oven, but the shelves must be evenly spaced.

The top oven rod shelf can be used in the main oven when cooking large quantities of food. (N.B. Maximum 3 shelves in the main oven).

Food or utensils should never be placed directly on the floor of the oven for cooking.

DO NOT allow young children near to the appliance when the main oven is in use as the surfaces get extremely hot.

MAIN OVEN UTENSILS

Do Not Use: Meat Pans larger than – 375mm x 300mm (15”x12”)
 Baking Trays larger than – 325mm x 250mm (13”x10”)

TEMPERATURE & TIME

When all three shelves are in use to cook large quantities of food, it may be necessary to increase the cooking times given in the temperature charts by a few minutes, to allow for the loss of heat due to extra time taken to load the oven, and the larger mass of food. Baking trays should have an even gap around the oven.

MAIN FAN OVEN OPERATION

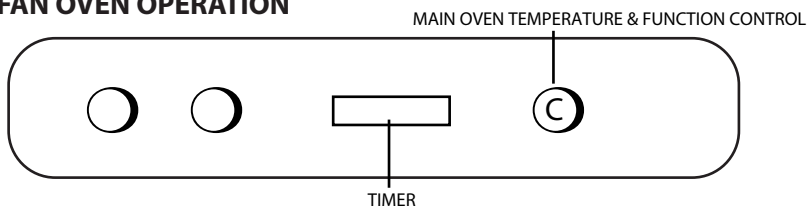

- Step 1 Check that the timer is in manual.
- Step 2 Place the shelf/shelves in the correct position (see Main Oven Temperature Charts).
- Step 3 Place the food centrally on the shelf ensuring the oven door is fully closed.
- Step 4 Select the required cooking temperature (80°C - MAX) by turning control (C) clockwise. The pilot light (●) will immediately come on, and remain on until the oven reaches the required temperature. The light will then automatically go off and on during cooking as the oven thermostat maintains the correct temperature.

Note: When you have finished using your cooker, always return the controls to their OFF (O) position. At the end of the cooking period there may be a momentary puff of steam when the door is opened. This will disperse in a few seconds and is a perfectly normal characteristic of an oven with a good door seal.

Using the Main Oven for Other Functions



FAN ONLY SETTING

DEFROSTING FROZEN MEAT & POULTRY

Joints of meat and whole birds should be defrosted slowly, preferably in a refrigerator (allowing 5-6 hours per lb.) or at room temperature (allowing 2-3 hours per lb.). Frozen meat or poultry must be completely defrosted before cooking in the oven.

However, to decrease the amount of time required to defrost food items, a non-heating fan only setting may be selected for the main oven only.

OPERATION: TO ASSIST IN DEFROSTING:

Place food in the oven and close the oven door.

Turn the Main Oven Temperature and Function Control (C) clockwise to the  setting.

This defrosts by circulating the air around the food, time to defrost will depend on type and size of the food.

NOTES: DO NOT defrost meat and poultry by warming the food through.

Foods ideally suited to defrosting using the fan only setting are cream/cream cakes, butter cream filled cakes, gateaux, cheese cakes, iced cakes, quiches, pastries, biscuits, bread, croissants, fruit and many delicate frozen foods.

If fish, meat and poultry are to be defrosted using the fan only setting, where possible it is recommended that the food should be small & thin.

The items should be placed so that the maximum amount of surface area is exposed to the circulating air, and that they are turned regularly to ensure even defrosting.

Larger cuts of meat and poultry may be defrosted by using the fan only setting up to a maximum weight of 2 kg (4lb 8oz).

It is important to wash both meat and poultry and cooking utensils immediately after defrosting and before cooking. Food should be cooked immediately after defrosting.

It is very important to strictly adhere to the basic principles of food handling and hygiene to prevent the possibility of bacterial growth.



LIGHT ONLY SETTING

When the Main Oven Temperature & Function Control (C) is turned clockwise to the  setting, the main oven light only will illuminate.

Using the Main Oven for Other Functions

'S' SLOW COOK SETTING

This is used for slow cooking, keeping food warm and warming plates for short periods. Extra care should be taken when warming bone china, as it may be damaged in a hot oven.

DO NOT place food or plates directly on the oven floor as this could damage both the oven lining and the plates which are being warmed.

ADVANTAGES OF SLOW COOKING ARE:

The oven stays cleaner because there is less splashing.
Timing of food is not as critical, so there is less fear of overcooking.
Inexpensive joints of meat are tenderised.
Fully loading the oven can be economical.
Cooking times can be extended in some cases by up to 2 hours.

OPERATION:

1. Place the prepared food in the main oven and ensure the door is fully closed.
2. Select Slow Cooking Temperature 'S' by turning Main Oven Temperature & Function Control (C) clockwise.

STORAGE & RE-HEATING OF FOOD:

1. If food is to be frozen or not used immediately, place it in a clean container and cool as soon as possible.
2. Always thaw frozen food completely in the refrigerator before re-heating.
3. Always reheat food thoroughly and ensure it is piping hot before serving.
4. Only re-heat food **once**.

POINTS TO CONSIDER WHEN PREPARING FOOD FOR SLOW COOKING

1. Make sure that the dishes to be used will fit into the oven ensuring enough room for air to circulate.
2. All dishes cooked on the slow setting will require a minimum of 6 hours, however, if they are cooked for 1-2 hours longer then deterioration in their appearance may be noticed.
3. Never cook joints of meat over 2.7kg (6 lb) or poultry over 2.0kg (4lb 8oz). We do not recommend that joints of meat or poultry are stuffed before cooking on the slow setting.
4. To seal in the meat juices, always cook meat or poultry at 170°C for 30 minutes before wrapping in foil and placing on a rack over a tin (to allow good air circulation) before turning the control to the slow setting and cooking immediately.
5. Always ensure that joints of pork and poultry are thoroughly cooked by checking with a meat thermometer before serving.
6. Always thaw frozen foods completely before cooking. We do not recommend placing frozen food in the oven to cook.
7. Always bring soups, liquids and casseroles to the boil before placing in the oven.
8. Ensure that casserole dishes have a good seal (not airtight) and cover to the top with foil to prevent loss of moisture.
9. Ensure that fruit and vegetables are cut into even sized small pieces to cook properly.
10. Always adjust seasoning before serving.
11. If using dried red kidney beans it is important that the beans are soaked and then boiled for a minimum of 10 minutes before using in any dish to destroy any toxins.
12. When cooking fish or egg dishes it may be necessary to check during cooking to avoid overcooking.

Temperature Conversion Scale

Gas Mark	°F	Main Conventional Oven	Main Fan Oven
1/2	250	120	100
1	275	140	120
2	300	150	130
3	325	160	140
4	350	180	160
5	375	190	170
6	400	200	180
7	425	220	200
8	450	–	210
9	475	–	220

Oven Temperature Charts - Meat

Food	Main Fan Oven Cooking		
	Pre-heat	Temperature °C	Time (approx.)
Meat	No	160/180	20-25 mins per 450g (1lb) + 20 mins extra
Beef	No	160/180	20-30 mins per 450g (1lb) + 25 mins extra
Lamb	No	160/180	20-30 mins per 450g (1lb) + 25 mins extra
Pork	No	160/180	15-20 mins per 450g (1lb) + 20 mins extra
Chicken/Turkey up to 4kg (8lb)	No	150/160	12-14 mins per 450g (1lb) + 12 mins extra
Turkey up to 5.5kg (12lb)	No	150	10 mins per 450g (1lb) e.g. 10kg (22lb) = 264 mins
Turkey over 5.5kg (12lb)	No	140	1 1/2 - 2 hours
Casserole Stews	No		

Note: Up to two shelves may be used in this oven. The position of these is not important providing they are evenly spaced.

Food	Top Oven Convection Cooking		
	Pre-heat	Temperature °C	Time (approx.)
Meat	Yes	170/180	35 mins per 450g (1lb) + 35 mins over
Beef/Lamb (Slow Roasting)	Yes	170/180	35 mins per 450g (1lb)
Beef/Lamb (Foil Covered)	Yes	170/180	40 mins per 450g (1lb) + 40 mins over
Pork (Slow Roasting)	Yes	190/200	40 mins per 450g (1lb)
Pork (Foil Covered)	Yes	170/180	25-30 mins per 450g (1lb) + 25 mins over
Poultry/Game (Slow Roasting)	Yes	195/200	25-30 mins per 450g (1lb)
Poultry/Game (Foil Covered)	Yes	150	2 - 2 1/2 hours
Casserole Cooking	Yes		

COOKING MEAT/POULTRY IN THE TOP OVEN

Small joints of meat up to 1.5Kg (3 lbs) and poultry up to 3.6Kg (8lbs) can be roasted in a small meat pan in the top oven.

IF USING ALUMINIUM FOIL

1. Never allow foil to touch sides of oven. 2. Never cover interior with foil. 3. Never cover shelves with foil.

The most accurate method of testing the readiness of joints of meat or whole poultry is to insert a meat thermometer into the thickest part of a joint of meat, or the thickest part of poultry thighs, during the cooking period. The meat thermometer will indicate when the required internal temperature has been reached.

Beef			Pork	Lamb	Poultry
Rare 60°C	Medium 70°C	Well Done 75°C	90°C	80°C	90°C

Oven Temperature Charts - Baking

Baking		Main Fan Oven Cooking			Top Oven Convection Cooking			
		<small>Note: Up to two shelves may be used in this oven. The position of these is not important providing they are evenly spaced.</small>						
Food	Pre-heat	Temperature °C	Time	Food	Pre-heat	Temperature °C	Time (approx)	Position from Base of Oven
Scones	Yes	210	9-12 mins	Scones	Yes	200	10-15 mins	1 A
Small Cakes	No	170	15-25 mins approx	Small Cakes	Yes	180	20-25 mins	1 A
Victoria Sandwich	No	160	20-30 mins	Victoria Sandwich	Yes	170	20-30 mins	1 A
Sponge Sandwich (Fatless)	Yes	180	15-20 mins	Sponge Sandwich (Fatless)	Yes	190	20-25 mins	1 A
Swiss Roll	Yes	190	10-15 mins	Swiss Roll	Yes	200	10-15 mins	1 A
Semi-rich Fruit Cake	No	150	1-1¼ hours	Semi-rich Fruit Cake	Yes	150	1¼ - 1½ hrs	1 A
Rich Fruit Cakes	No	130	Depending on size	Rich Fruit Cakes	Yes	130/140	2½ - 3 hrs	1 A
Shortcrust Pastry	No	180/190	Depending on use	Shortcrust Pastry	Yes	190/200	Depending on use	1 A
Puff Pastry	yes	195/200	Depending on use	Puff Pastry	Yes	200/210	Depending on use	1 A
Yorkshire Pudding	Yes	180	30-45 mins	Yorkshire Pudding	Yes	180/190	30-45 mins	1 A
Individual Yorkshire Pudding	Yes	190	20-25 mins	Individual Yorkshire Pudding	Yes	190/200	20-30 mins	1 A
Milk Pudding	No	140	1¼-1½ hours	Milk Pudding	Yes	150	1½ - 2 hrs	1 A
Baked Custard	No	130	40-50 mins	Baked Custard	Yes	150	40-50 mins	1 A
Bread	Yes	200	30-35 mins	Bread	Yes	200	30-40 mins	1 A
Meringues	No	80/90	3-3½ hours	Meringues	Yes	100	3 - 3½ hrs	1 A

Note: If soft tub margarine is being used for cake making, we would recommend using the all in one method and to reduce the temperature by 10°C. Temperatures recommended in this chart refer to cakes made with block margarine or butter only.

Cooking Results Not Satisfactory

GRILL

- Uneven cooking front to back** Ensure that the grill pan is positioned centrally below the grill element.
- Fat splattering** Ensure that the grill pan is not lined with foil. Ensure that the grill setting control (A) is not set too high. If Solarplus grill – use anti-splash tray supplied under the food support.

BAKING GENERAL

- Uneven rising of cakes** Ensure that the oven shelves are level.
- Sinking of cakes** The following may cause cakes to sink:
1. Pre-heating of fan ovens – not always necessary.
 2. Cooking at too high a temperature – reduce standard temperatures by 25°C for fan ovens.
 3. Using normal creaming method with a soft margarine. If using soft margarine, use an all in one method instead of the traditional creaming of the margarine and sugar. Remember when using a food mixer or processor not to over-cream soft margarine.
- Over/undercooking** Refer to the cooking times and temperatures given in the Oven Temperature Charts provided, however, it may be necessary to increase or decrease temperatures by 10°C to suit personal taste.
- Do not use utensils greater than 56mm (2¼") in height for roasting.

TOP OVEN BAKING

- Uneven cooking front to back** Ensure that the cooking utensil is at least 100mm (4") from the front of the shelf.
- Uneven rising** Ensure that the shelf is level (as above) and that the food is positioned correctly in the oven.
- Overcooking** Remember to reduce cooking temperatures by 10°C from standard recipes when using the top oven.
- Food is taking too long to cook** Ensure that the cooking utensil used in the top oven is not larger than 300mm x 225mm (12"x 9"), e.g. **Do Not** use the main oven meat pan.
- Only cook one item at a time to avoid overloading the oven.

Care and Cleaning

Warning: Before cleaning, please ensure that the electricity supply to the appliance is switched off and the appliance is fully cold.

1. "STAYCLEAN" OVEN LINERS (Top Oven sides, Main Oven sides, rear panel and roof)

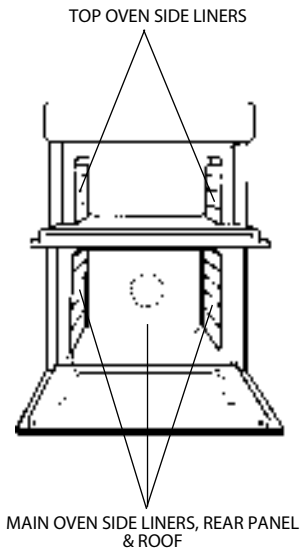

(a) How "Stayclean" works.

The surfaces of the "Stayclean" oven liners (Main Oven rear panel) are treated with a special vitreous enamel which absorbs cooking soils. At temperatures of 220°C (425°F) or above, the special surface enables these soils to be slowly destroyed.

The higher the temperature the more effective it is.

(b) Cleaning.

In most cases normal cooking operations at 220°C (425°F) will permit this cleaning operation to proceed during cooking. However if higher cooking temperatures are not used regularly, it may be necessary, in order to prevent heavy soiling, to run the ovens without shelves or meat pan, at a maximum setting for a couple of hours. It should not normally be necessary to clean the "Stayclean" panels with water. If the user feels it is desirable to do so, wipe them over with a clean, soapy cloth, followed by a wipe with a clean damp cloth.

DO NOT use biological washing powder, harsh abrasives or chemical oven cleaners of any kind as this could damage the "Stayclean" oven liners (Main Oven rear panel).

Care and Cleaning

2. CLEANING GRILL, TOP OVEN AND MAIN OVEN

(a) Base & Rear of Top Oven and Base of Main Oven.

Wipe out the oven with a damp soapy cloth. For more stubborn stains on the base of the oven use a well soaped fine steel wool soap pad.

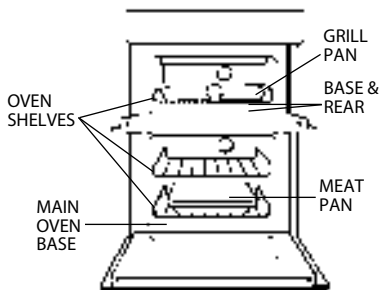

(b) Grill Pan, Meat Pan & Oven Shelves.

To prevent stains from being burnt on to the grill pan, food support and rod shelf, always wash immediately after use in warm soapy water.

Use a well soaped fine steel wool soap pad to remove stubborn stains from the rod shelves, grill pan, meat pan and the base of the oven.

DO NOT use aerosol cleaners on this oven as they could adversely affect the fan motor unit, and cannot be wiped off the fan blade.

(c) Removable grill roof liner (Top Oven).

Pull the grill roof liner out slowly, taking care not to damage the elements. Clean using a damp, soapy cloth. If stubborn stains remain, gently clean with a well soaped fine steel wool soap pad and soapy water and then wipe over with a clean damp cloth.

3. OVEN DOORS



(a) Control Panel

Regularly wipe with a clean, damp cloth and polish with a clean, dry cloth.

(b) Trims

It is advisable to clean the trims regularly to prevent any build up of soiling which may detract from the appearance of the cooker. The recommended method of cleaning is to wipe over the trims with a clean, soft cloth wrung out in warm water, or mild non abrasive cleaner. (If in doubt try the cleaner on a small area of trim which is not noticeable in normal use), then after wiping with a cloth wrung out in clear water, dry with a clean, soft cloth.

(c) Inner Door Panels & Glass

Open the door fully. The glass panel may now be washed. Stubborn stains can be removed by using a well soaped, fine steel wool soap pad.

(d) Stainless trims (UT47 only)

Regularly wipe with a clean, damp cloth and polish with a clean dry cloth.

DO NOT use scouring pads, or abrasive powder, which will scratch the glass.

Care and Cleaning

4. REPLACEMENT OF THE OVEN LAMP

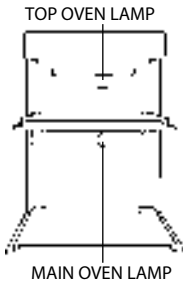

Warning: To avoid electric shocks - please ensure that the electricity supply to the appliance is switched off and the appliance is fully cold, before removing the lamp lens.

Open the oven door and remove the oven shelves.
Using a thick cloth, grip the lamp lens, unscrew anti-clockwise and remove the lens.
Carefully unscrew the bulb anti-clockwise.
Fit replacement bulb (15W 300°C SES) and refit lens.

5. HOW TO CLEAN THE LAMP LENS

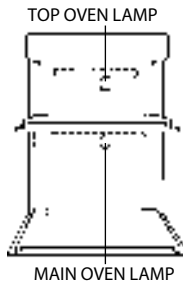

Warning: To avoid electric shocks - please ensure that the electricity supply to the appliance is switched off and the appliance is fully cold, before cleaning lamp lens.

Open the oven door and remove the oven shelves.
Using a thick cloth, grip the lamp lens, unscrew anti-clockwise and remove.
Clean with a non-abrasive cleansing cream and refit lamp lens.

DO NOT use scouring pads, or abrasive powder, which will scratch the glass lens

Care and Cleaning

TO CLEAN THE INSIDE OF OUTER AND INNER GLASS PANELS

Warning: Always switch your appliance OFF at the mains supply and allow to cool before cleaning.

Fig. 1

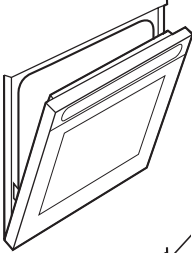

1. Position top or main oven door as shown in fig. 1.

Note: The door can be wedged open using a towel between the door and the side trim thus leaving your hands free.

Fig. 2

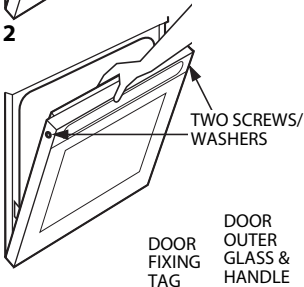

2. Grip inner door panel and handle/outer glass assembly. Remove two screws and fibre washers (put to one side) as shown in fig. 2.
3. Pull handle/outer glass assembly at the top outwards while still holding the inner door panel and unhook handle/outer glass assembly at the bottom by lifting handle/outer glass assembly upwards as shown in fig. 3. Take care not to dislodge rubber grommets in bottom of door.
4. Return the inner door panel to the closed position as shown in fig. 4.

Warning: Care must be taken when closing the door inner panel as the door will attempt to snatch shut, without the weight of the handle/outer glass assembly avoid trapping your fingers.

Fig. 3

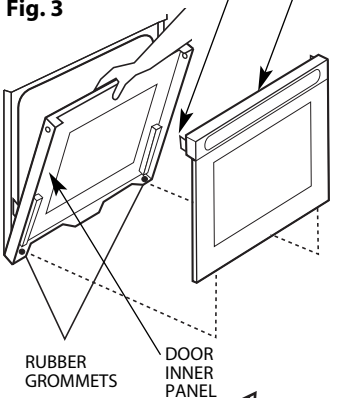

5. The inside of inner and outer door glass can now be cleaned using a clean, damp cloth and polished using a clean, dry cloth.
6. Refit the handle/outer glass assembly by opening the oven door and hold taking care not to trap your fingers, see fig. 3. Hook the handle/outer glass assembly back into the rubber grommets at the bottom of the inner door panel, see fig. 3. Fit the handle/outer glass assembly back in position at the top ensuring the fixing tags on the handle/outer glass assembly fit inside the door inner panel. While still holding door together, refit the two screws and washers, see fig. 2.

Fig. 4

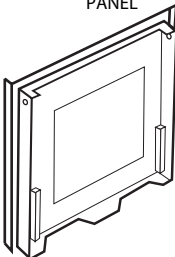

Never operate the ovens without the outer glass panels correctly refitted.

Installation

Electrical Requirements

For your own safety, we recommend that your cooker is installed by a competent person such as one who is registered with NICEIC (National Inspection Council for Electrical Installation Contracting). The cooker should be installed in accordance with the latest edition of the IEE Regulations.

Warning: This appliance must be earthed.

Electrical Connections

The installer must check that the voltage shown at the rating plate corresponds with the house electricity supply.

The cooker must be supplied via a suitable double pole isolating switch, having a contact separation of at least 3mm in all poles placed in a readily accessible position adjacent to the cooker.

If the cooker is to be wired into a connector unit, this may be positioned behind the cooker providing the following requirements are met:

- i) The connector unit must not project from the wall more than 25mm.
- ii) The top of the connector must not be more than 130mm above floor level.

Remove the terminal cover at the rear base of the cooker. Pass the cable through the cable clamp and connect to the appropriate terminals provided.

Allow sufficient cable for any future servicing.

Tighten the screws on the cable clamp and replace the cover.

Make main connections in the connector unit or cooker control unit.

This appliance conforms to B.S. EN 55014 regarding suppression of Radio and Television reception interference.

A double Pole control switch having a minimum rating of 32 amps should be used to feed the cooker using a suitably rated cable.

Where a hob is fitted adjacent to or over the cooker, a 45 amp Double Pole control switch should be used to feed both units via separate suitably rated cables.

We recommend a minimum of 4mm² PVC insulated twin and earth cable conforming to B.S. 6004 for connection of each appliance.

Where a hob is fitted above the cooker the cable connecting the hob to the cooker control unit must be of 2.5mm² 85°C heat resistant cable to BS6141 table 15

In all cases adhere to routing details (see fig. 5).

This appliance must not be installed over any other appliance that generates heat such as a plinth heater

Note: Due to many different types of installation, a mains cable is not supplied with this product. The installer will fit the correct type and length of cable.

Installation

GENERAL

The appliance is designed to be mounted on a floor between two adjacent cabinets. The cabinets must be securely fixed to the wall and the cooker securely fixed to the cabinets.

This cooker must not be used free standing.

Note; This cooker must not be fitted on a platform.

FINAL INSTALLATION

- a. Ensure that the adjacent cabinets and the gap between them have dimensions in accordance with the diagram.
- b. Assemble the plastic plugs provided into the fixing brackets. See diagram.
- c. Fix the fixing brackets to the sides of the adjacent cabinets so that the centre line of the brackets are 565mm above the top of the plinth line and the front face of the plastic plug is level with the front face of the cabinet sides. See diagram.
- d. Adjust the feet on the cooker to their minimum position, i.e. fully screwed in.
- e. Slide the cooker centrally into the space between the cabinets ensuring the following:
 - i) The gap between the cabinet sides and the cooker is even along the length of the cabinet sides.
 - ii) The cable is routed away from any vents in the rear panel and is not trapped between the cooker and the wall, adjacent cabinets or under the feet
- f. Adjust the feet using an open ended spanner until the bottom of the cooker door is in line with the top of the plinth. Using a spirit level, check that the cooker is level in all directions.
- g. Check that the plinth can be fitted. If necessary re - adjust the feet and check that the cooker is level.
- h. Open the top oven door and fix the cooker to the brackets through the holes in the side trims.
- i. Fix the plinth in position.
- j. Ensure that there is a minimum gap of 1mm between the cooker side trim and the adjacent cabinet doors or drawer fronts.
- k. If a hob is to be installed directly above the cooker it must not project downwards more than 20mm below the underside of the work top. Any projection of more than 10mm must not project more than 500mm from the wall.

Fig. 5

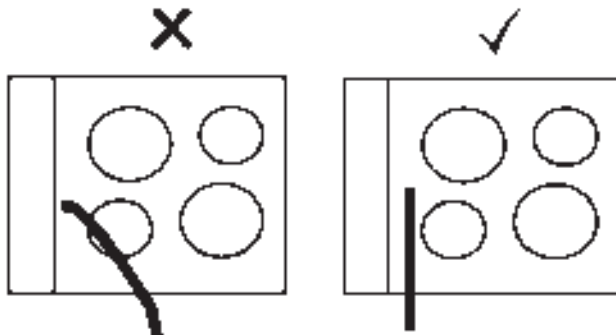

Installation

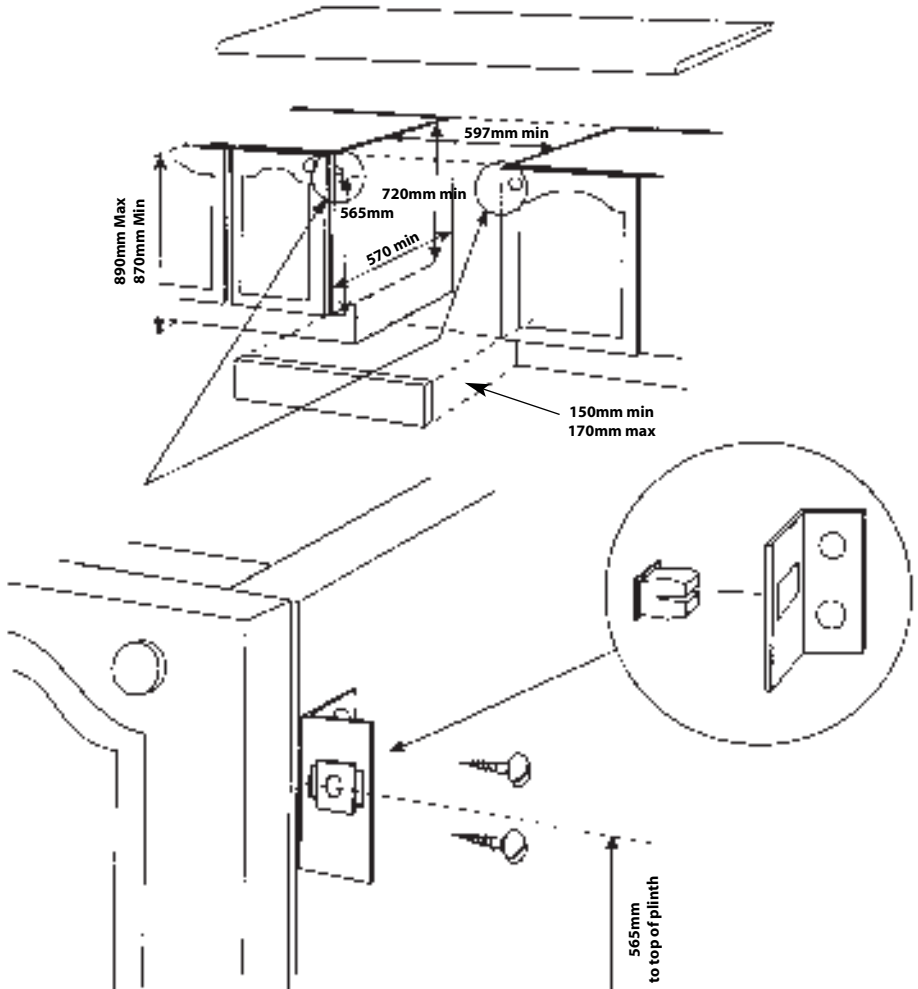

A minimum distance of 25mm should be maintained between the front face of the cabinet side and the front face of the plinth.

Installation

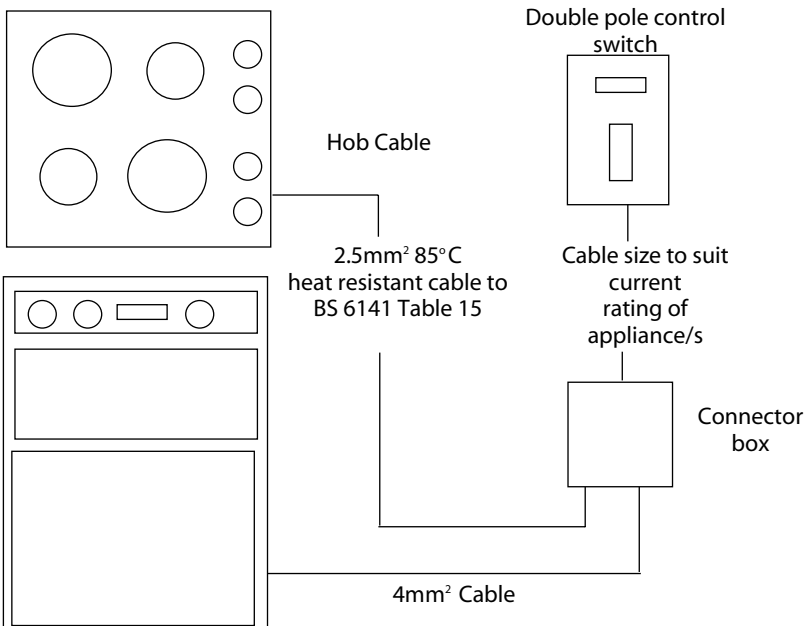
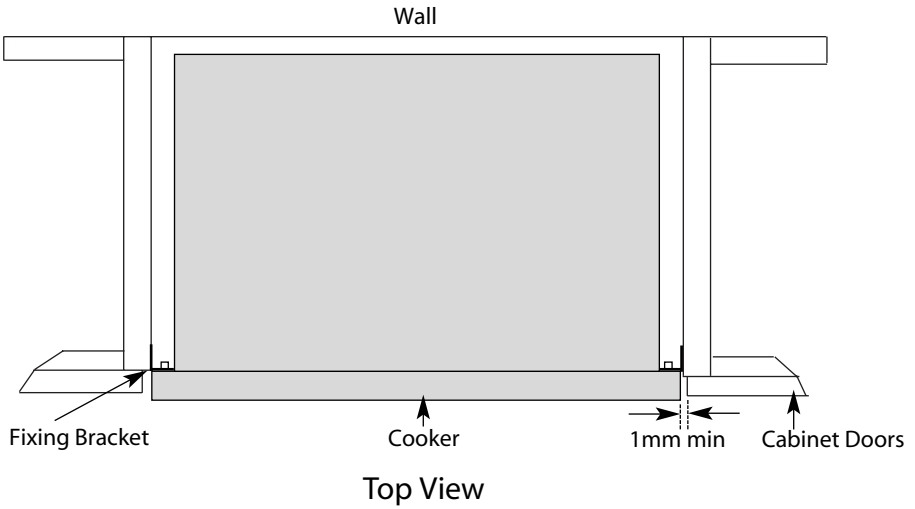

If something goes wrong...

**Before calling a Service Engineer, please check through the following lists.
THERE MAY BE NOTHING WRONG.**

Problem	Check
Nothing works.	(a) Check If you find :- Display is blank. Then it is likely that there is no electricity supply to your oven. Check: (i) That the main cooker wall switch is turned on. (ii) Check other appliances to see if you have a power cut. (iii) Check the main circuit breaker for the property.
Display shows 0.00 AUTO.	The power supply to your oven has possibly been interrupted, but has now come back on again. Reset the timer to the correct time of day and "Manual" operation using instructions given in the timer section of the book.
Main & Top Ovens do not work, but the Grill works.	Check the following to ensure that the timer is in Manual Mode: Check that the Auto Symbol is <u>not</u> lit up and is not flashing. See timer section for instructions on how to return timer to "Manual".
Top Ovens and Grill do not work, but the Main Oven works.	Operating the cooker under the following conditions may cause a safety device to operate. (a) Grilling with the door closed - always grill with the door open to the correct position - see grilling. (b) Grilling for an excessively long period at maximum setting - see grilling guide. (c) Grilling with inadequate ventilation in the cabinet - see installation instructions.
Grill does not work.	Check that you have selected :- "Grill" function on the "Top/Oven Grill Select" knob (B) and a Grill setting on the "Grill" knob (A) - see grilling page.
Grill keeps turning on and off.	When the "Grill" control (A) is operating at less than MAX, the grill will cycle on and off, this is normal and is <u>not</u> a fault.
Can not set an "Auto Cook" programme	Remember: "Cook Period" is the actual length of time for which, the timer will switch the oven(s) on as part of an "Auto Cooking" programme.
Draught from beneath control panel.	A gentle flow of air will be blown from beneath the control panel when the appliance is used. If the appliance is still warm, this cooling fan may run on, or restart itself after all of the controls have been turned off. The fan will stop once the appliance has been cooled. This is normal and not a fault.
Timer buzzer/bleeper operates continually	Press the minute minder button to silence the Buzzer/Bleeper.

If you have been through the above list and there is still a problem, contact Service (see KEY CONTACTS, back page).

Hotpoint Service Cover

Satisfaction Guaranteed or Your Money Back

Hotpoint gives you a unique 'Satisfaction Guaranteed' promise – valid for ninety days after you have purchased your Hotpoint product. If there is a technical problem with your Hotpoint appliance, just call Hotpoint Service (see back page). If necessary we will arrange for an engineer to call. If the technical problem is not resolved under this Guarantee, Hotpoint will replace your appliance or, if you prefer, give you your money back. Your statutory rights are not affected, and the Guarantee is additional and subject to the terms of Hotpoint's Five Year Parts Guarantee.

Hotpoint's Free Five Year Guarantee

From the moment your appliance is delivered Hotpoint guarantees it for **FIVE YEARS**.

- In the Five Years all replacement parts are **FREE** provided that they are fitted by our own Service Engineer. During the first year our Engineer's time and labour is also free.
- Our guarantee covers loss of food in our refrigeration and freezer products up to £250 during the first year, subject to verification by one of our engineers.
- After the first year we will charge for our Engineer's time and labour. We do, however, operate a range of Service Plans (see opposite) which, for an annual payment, enables you to cover any repair costs which may be necessary.
- All our service repairs are guaranteed for twelve months in respect of our labour and any parts fitted.
- The appliance must be used in the United Kingdom, and must not be tampered with or taken apart by anyone other than our own Service Engineers.
- You may, however, buy parts which can be safely fitted without specialist knowledge or equipment. The correct fitting of such parts, provided they are genuine Hotpoint spares, will not affect your Guarantee. Parts are available from our Hotpoint Spares Centres (see back page).
- Our guarantee does not cover the cost of any repair, or loss of food in refrigeration products, due to power failure, accidents or misuse. Nor does it cover the cost of any visits to advise you on the use of your appliance. Please read thoroughly the instruction book supplied with this appliance.
- If at any time during the Guarantee period we are unable to repair your appliance, we will refund any repair costs paid to us in the previous twelve months. We will also offer you a new appliance at a reduced charge instead of a repair.
- Our Guarantee is in addition to and does not affect your legal rights.
- Should you need independent advice on your consumer rights, help is available from your Consumer Advice Centre, Law Centre, Trading Standards Department and Citizens Advice Bureau.
- All Hotpoint servicing is carried out by our own Service Organisation located throughout the United Kingdom and Eire. We will be happy to deal with any problems which you may have.

Hotpoint's Extended Warranties

Whether you have just one or a number of Hotpoint appliances in your kitchen, Hotpoint has a range of Service Plans to give you complete peace of mind. They enable you to extend your one year labour guarantee so that you can have repairs completed **FREE** during the membership period.

Service Cover

We offer a number of payment methods; cheque, credit card or you can spread the cost and pay by direct debit (full details can be obtained on Free phone 0800 716356). This covers you for all repairs during the period of cover, which can be from 1 to 4 years. Service Cover also includes loss of food, up to the value of £250, in refrigeration appliances. There is also an option of Service Cover with Maintenance at an additional cost. This includes an annual Electrical and Safety check and replacement of any parts as necessary.

Kitchen Cover

An annual payment covers you for all repairs for all your Hotpoint appliances which are less than ten years old. It also covers the cost of loss of food up to £250 in our refrigeration and freezer products. There is also the option of Kitchen Cover with Maintenance at an additional cost. Any additional Hotpoint appliances purchased after you have joined Hotpoint Kitchen Cover will automatically be included during the annual period of cover without further charge.

Appliance Registration

To ensure that you have the opportunity to benefit from any of the above Service Schemes and other offers you should complete and return immediately the Appliance Registration Form/Questionnaire supplied with this appliance. Full details and costs of our Service Schemes, together with an application form, will be sent to you at the end of the first year of the guarantee.

Annual Safety/Maintenance Checks

Hotpoint strongly recommends that all its appliances are regularly checked for electrical and mechanical safety, whether or not they are covered by a Service Plan. Worn door gaskets or hoses may cause a leak on an appliance, which could become dangerous if neglected.

Proof of Purchase

For future reference please attach your purchase receipt to this booklet and keep it in a safe place.

Spares and Accessories

Spares and accessories can be ordered from your local Hotpoint Spares Centre (see back page), using the order form enclosed.

NOTE: Our Engineers will use every effort to avoid damage to floor coverings and adjacent units when carrying out repairs/service work, but in locations where the Engineer advises you that it will be impossible to move appliances without risk of damage, he will only proceed with your approval that no liability is accepted.

Key Contacts

Service

Hotpoint has the largest appliance manufacturer's service team in Europe, trained specialists directly employed by us to ensure your complete confidence.

Repair Service

UK: 08709 066 066

Republic of Ireland: 1850 302 200

You will be asked for the following information:-

Name, address and postcode.

Telephone number

Model / Serial number of the appliance

Clear and concise details of the query or fault

Place and Date of purchase

(Please keep the receipt as evidence will be required when the engineer calls).

Extended Warranty

To join: UK 08709 088 088

Republic of Ireland: 1850 502 200

Genuine Parts & Accessories Mail Order Hotline

UK: 08709 077 077

Republic of Ireland: (01) 842 6836

For further product information 08701 506070

All Hotpoint Services are offered as an extra benefit and do not affect your statutory rights.



General Domestic Appliances Limited, Morley Way, Peterborough, PE2 9JB

Free Manuals Download Website

<http://myh66.com>

<http://usermanuals.us>

<http://www.somanuals.com>

<http://www.4manuals.cc>

<http://www.manual-lib.com>

<http://www.404manual.com>

<http://www.luxmanual.com>

<http://aubethermostatmanual.com>

Golf course search by state

<http://golfingnear.com>

Email search by domain

<http://emailbydomain.com>

Auto manuals search

<http://auto.somanuals.com>

TV manuals search

<http://tv.somanuals.com>