

How to get the best from **your** refrigerator

How to save energy —
inside front cover

How the Energy-Saver Switch
works — page 3

How long can you store
foods? — page 4

You can rearrange your
refrigerator's shelves — page 5

Save time and money.
Before you call for service,
use the Problem Solver —
pages 7 and 8

Models
CTF17
CTF19

Top Freezer
No-Frost



Your Direct Line to General Electric
The GE Answer Center 800.626.2000

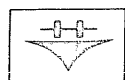

Hotpoint

39-6193

Contents

Help us
help you...

	Page
Energy-Saving Tips	Inside Front Cover
Important Cautions	1
How to Connect Electricity	2
Installation Requirements	2
How to Adjust Rollers	2
How to Adjust Leveling Legs	2
How to Set Temperature Controls	3
How to Use Energy-Saver Switch	3
Food Storage Suggestions	4
Shelves and Storage Drawers	5
Ice Service	5
User Maintenance Instructions	6
Accessories	6
Problem Solver	7, 8
Special Services	Inside Back Cover
Warranty	Back Cover

Read this book carefully.

It is designed to help you operate and maintain your new refrigerator properly.

Keep it handy for answers to your questions.

If you don't understand something or need more help...

Call, toll-free:

The GE Answer Center™

800.626.2000

consumer information service

or write (include your phone number)

Consumer Affairs

Hotpoint

Appliance Park

Louisville, KY 40225

Write down the model and serial numbers.

You'll find them on a label at the bottom, just inside the fresh food compartment door.

These numbers are also on the Consumer Product Ownership Registration card that came with your refrigerator. Before sending in this card, please write these numbers here:

Model Number _____

Serial Number _____

Use these numbers in any correspondence or service calls concerning your refrigerator.

If you received a damaged refrigerator, immediately contact the dealer (or builder) that sold you the refrigerator.

Save time and money.

Before you call for service, check the Problem Solver on pages 7 and 8. It lists minor causes of operating problems that you can correct yourself. It could save you an unnecessary service call.

Energy-Saving Tips

- Location of your refrigerator is important. Avoid locating it next to your range, a heating vent or where sun will shine directly on it.
- Don't open doors more often than necessary.
- Close the doors as soon as possible, particularly in hot, humid weather.
- Keep Energy Saver Switch in the left position unless moisture forms on the outside of the refrigerator.
- Be sure the doors are closed tightly. Before leaving the house or retiring for the night, check to be sure doors haven't been left ajar inadvertently.
- Store only those foods requiring refrigeration in your refrigerator.
- Allow hot foods to cool (until warm to the touch) before placing them in your refrigerator.
- Wipe all moisture from bottles and cartons before putting them in the refrigerator.
- Keep all foods covered to reduce moisture build-up inside the refrigerator.
- If you turn controls to coldest position for quick chilling or freezing, be sure to turn them back to regular settings.
- Don't overcrowd your refrigerator. Overcrowding can require extra electrical energy to keep everything cool.

Important Cautions

Read all instructions before using this appliance.

WARNING—When using this appliance, always exercise basic safety precautions, including the following:

- Use this appliance only for its intended purpose as described in this Use and Care Book.
- This refrigerator must be properly installed in accordance with the Installation Instructions before it is used. See grounding instructions below and on page 2.
- Never unplug your refrigerator by pulling on the power cord. Always grip plug firmly and pull straight out from the receptacle.
- Repair or replace immediately all electric service cords that have become frayed or otherwise damaged. Do not use a cord that shows cracks or abrasion damage along its length or at either the plug or connector end.
- When moving your refrigerator away from the wall, be careful not to roll over or damage the power cord.
- After your refrigerator is in operation, do not touch the cold

surfaces, particularly when hands are damp or wet. Skin may adhere to these extremely cold surfaces.

- If your refrigerator has an automatic icemaker, do not place fingers or hands on the automatic icemaking mechanism while the refrigerator is plugged in. This will prevent contact with the moving parts of the ejector mechanism, or with the heating element that releases the cubes.

- Don't refreeze frozen foods which have thawed completely. The United States Department of Agriculture in Home and Garden Bulletin No. 69 says:

"...You may safely refreeze frozen foods that have thawed if they still contain ice crystals or if they are still cold—below 40°F.

"...Thawed ground meats, poultry, or fish that have any off-odor or off-color should not be refrozen and should not be eaten. Thawed ice cream should be discarded. If the odor or color of any food is poor or questionable, get rid of it. The food may be dangerous to eat.

"Even partial thawing and refreezing reduce the eating quality of

foods, particularly fruits, vegetables, and prepared foods. The eating quality of red meats is affected less than that of many other foods. Use refrozen foods as soon as possible to save as much of their eating quality as you can."

- If your old refrigerator is still around the house but not in use, be sure to remove the doors. This will reduce the possibility of danger to children.

- Unplug your refrigerator:

A. Before making any repairs.

Note: We strongly recommend that any servicing be performed by a qualified individual.

B. Before cleaning.

C. Before replacing a burned-out light bulb, the refrigerator should be unplugged in order to avoid contact with a live wire filament. (A burned-out light bulb may break when being replaced.)

Note: Turning control to OFF position does not remove power to the light circuit.

- Do not operate your refrigerator in the presence of explosive fumes.

Installation Requirements — IMPORTANT... Please Read Carefully

How to connect electricity

For personal safety, this appliance must be properly grounded.

The power cord of this appliance is equipped with a three-prong (grounding) plug which mates with a standard three-prong (grounding) wall receptacle (Fig. 1) to minimize the possibility of electric shock hazard from this appliance.

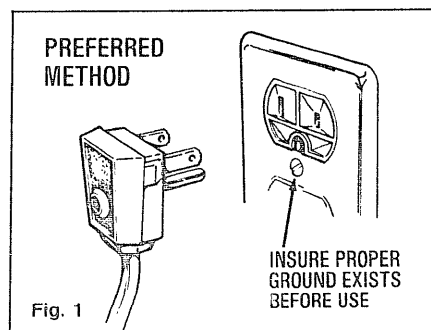

Have the wall receptacle and circuit checked by a qualified electrician to make sure the receptacle is properly grounded.

Where a standard two-prong wall receptacle is encountered, it is the personal responsibility and obligation of the customer to have it replaced with a properly grounded three-prong wall receptacle.

DO NOT, UNDER ANY CIRCUMSTANCES, CUT OR REMOVE THE THIRD (GROUND) PRONG FROM THE POWER CORD.

(continued next page)

Installation Requirements (continued) —IMPORTANT... Please Read Carefully

Use of adapter plug

Because of potential safety hazards under certain conditions, we strongly recommend against use of an adapter plug. However, if you still elect to use an adapter, where local codes permit, a TEMPORARY CONNECTION may be made to a properly grounded two-prong wall receptacle by use of a UL listed adapter (Fig. 2) available at most local hardware stores.

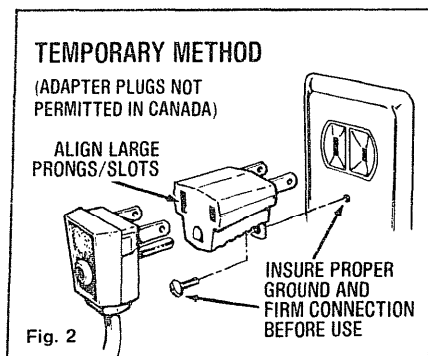

The larger slot in the adapter must be aligned with the larger slot in the wall receptacle to provide proper polarity in the connection of the power cord.

CAUTION: Attaching adapter ground terminal to wall receptacle cover screw does not ground the appliance unless cover screw is metal, and not insulated, and wall receptacle is grounded through house wiring. Customer should have the circuit checked by a qualified electrician to make sure the receptacle is properly grounded.

When disconnecting the power cord from the adapter, always hold the adapter with one hand. If this is not done, the adapter ground terminal is very likely to break with repeated use.

Should the adapter ground terminal break, DO NOT USE the appliance until a proper ground has again been established.

Use of extension cords

Because of potential safety hazards under certain conditions, we strongly recommend against the use of an extension cord. However, if you still elect to use an extension cord, it is absolutely necessary that it be a UL listed 3-wire grounding type appliance extension cord and that the current carrying rating of the cord be 15 amperes minimum. Such extension cords are obtainable through your local service organization.

The refrigerator should always be plugged into its own individual electrical outlet—

(115 volt, 60 Hertz, or 100 volt, 50 Hertz, single phase AC).

This is recommended for best performance and to prevent overloading house wiring circuits, which could cause a possible fire hazard from overheating wires.

Refrigerator Installation

Location

Do not install refrigerator where temperature will go below 60°F. because it will not run often enough to maintain proper temperatures.

Do install it on a floor strong enough to support a fully loaded refrigerator.

Also see Energy-Saving Tips regarding location.

Clearances

Allow 5/8" at each side and 1" over the top for ease of installation and proper air circulation.

When building a new home...

consider providing water supply to refrigerator location. It will simplify connection of optional automatic icemaker should you wish to install one at a later date.

Rollers/Leveling Legs

Adjustable rollers (on models so equipped) which enable you to move refrigerator away from wall for cleaning, or **leveling legs**, are located behind base grille. They should be set so refrigerator is firmly positioned on floor and front is raised just enough that doors close easily when opened about halfway.

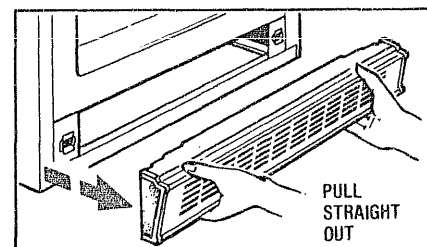

To adjust rollers or leveling legs, remove base grille by grasping it at bottom and pulling it straight out.

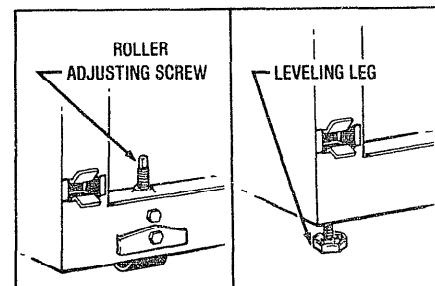

Turn roller adjusting screws or leveling legs **clockwise to raise** refrigerator, **counterclockwise to lower** it. Use adjustable wrench or pliers on the roller adjusting screw's 3/8" hex head bolt.

When adjusting rollers or leveling legs for proper door closure, bottom front edge of cabinet should be approximately 5/8" from floor.

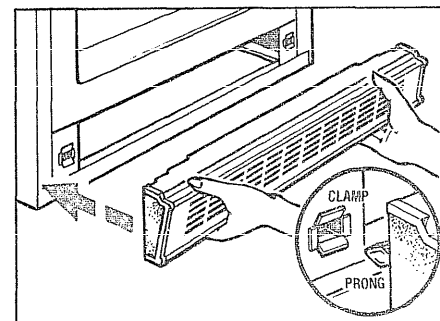

To replace base grille, align prongs on back of grille with clamps in cabinet and gently push forward until grille snaps into place.

Operating Your Refrigerator

Set the temperature controls

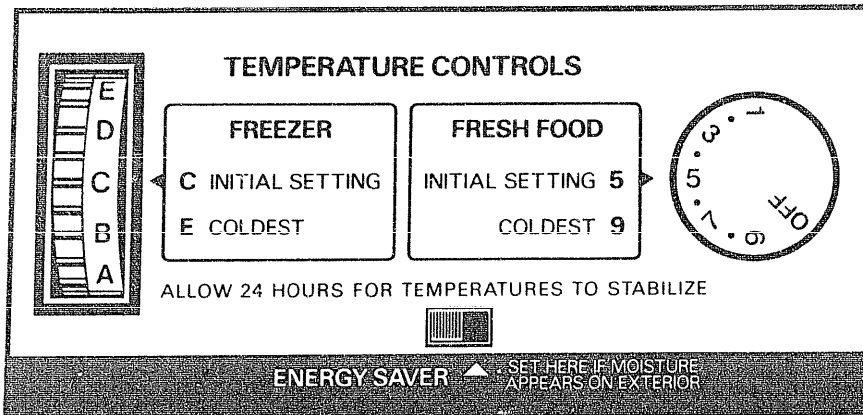

Your refrigerator has two controls that let you regulate the temperature in the fresh food and freezer compartments.

INITIALLY, set the **FRESH FOOD** control at 5 and the **FREEZER** control at C.

For colder or warmer temperatures, adjust the desired compartment control one letter or number at a time.

IMPORTANT

When initially setting the controls or when adjusting them, allow 24 hours for the temperatures to stabilize, or even out.

Note: Turning the fresh food control to "OFF" turns off BOTH compartments—fresh food AND freezer.

How to test temperatures

Use the milk test for the fresh food compartment. Place a container of milk on the top shelf in the fresh food compartment. Check it a day later. If the milk is too warm or too cold, adjust the temperature controls.

Use the ice cream test for the freezer compartment. Place a container of ice cream in the center of the freezer compartment. Check it after a day. If it's too hard or too soft, adjust the temperature controls.

Always allow 24 hours for the refrigerator to reach the temperature you set.

If you turn your household thermostat below 60°F. at night

...you may want to turn the lettered control one step colder, as from "C" to "D." Cooler temperatures in the house may cause the freezer controls to operate less frequently, thus allowing the freezer compartment to warm somewhat. To protect your frozen food supply, leave your lettered setting at this colder setting for the entire winter or for whatever period of time you are turning down your thermostat. This is especially important when the thermostat is turned down for an extended period.

This change should have no effect on your fresh food section. However, if freezing occurs, turn the numbered control one step warmer, as from "5" to "4."

When you stop turning the thermostat down, turn temperature controls back to their regular settings.

Energy Saver Switch

The Energy Saver Switch is located on the temperature control panel.

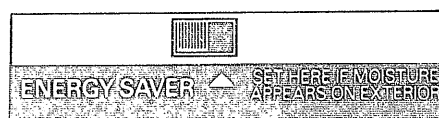

To reduce the amount of electricity required to operate your refrigerator, push switch to the left position.

This turns off heaters in your refrigerator that prevent moisture from forming on the outside.

Use of the Energy Saver Switch can save you money. Estimated yearly savings, depending on your local electric rates, are as follows:

Model	Estimated Yearly Savings			Energy Savings (Approx.)
	Electric Rate (Per Kwh)			
	\$.05	\$.08	\$.11	
CTF17	\$ 9.00	\$16.00	\$21.00	16%
CTF19	\$10.00	\$17.00	\$23.00	16%

With the heaters turned off, there is a chance that moisture may form on the outside of your refrigerator, especially when the weather is humid. The humidity is most likely to be high in the summer, in the early morning hours, and in homes which are not air conditioned.

Over an extended period of time, moisture that forms on the outside may cause deterioration of the paint finish. It will be important to protect the finish by using appliance polish wax as described on page 6.

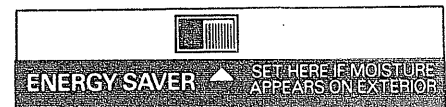

When the Energy Saver Switch is pushed to the right, electricity flows through the low wattage heaters which warm the outside of the cabinet and, under most conditions, prevent the forming of moisture or water droplets.

No defrosting

It is not necessary to defrost the freezer or fresh food compartments. Your refrigerator is designed and equipped to defrost itself automatically.

Food Storage Suggestions

Suggested storage times for meat and poultry*

Eating quality drops after time shown	IN REFRIGERATOR AT 35° to 40°F.	IN FREEZER AT 0°F.
	DAYS	MONTHS
Fresh Meats		
Roasts (Beef and Lamb)	3 to 5	6 to 12
Roasts (Pork and Veal)	3 to 5	4 to 8
Steaks (Beef)	3 to 5	6 to 12
Chops (Lamb)	3 to 5	6 to 9
Chops (Pork)	3 to 5	3 to 4
Ground and Stew Meats	1 to 2	2 to 3
Variety Meats	1 to 2	3 to 4
Sausage (Pork)	1 to 2	2 to 3
Processed Meats		
Bacon	7	1
Frankfurters	7	½
Ham (Whole)	7	1 to 2
Ham (Half)	5	1 to 2
Ham (Slices)	3	1 to 2
Luncheon Meats	3 to 5	Freezing not recommended.
Sausage (Smoked)	7	
Sausage (Dry and Semi-Dry)	14 to 21	
Cooked Meats		
Cooked Meats and Meat Dishes	3 to 4	2 to 3
Gravy and Meat Broth	1 to 2	2 to 3
Fresh Poultry		
Chicken and Turkey (Whole)	1 to 2	12
Chicken (Pieces)	1 to 2	9
Turkey (Pieces)	1 to 2	6
Duck and Goose (Whole)	1 to 2	6
Giblets	1 to 2	3
Cooked Poultry		
Pieces (Covered with Broth)	1 to 2	6
Pieces (Not Covered)	1 to 2	1
Cooked Poultry Dishes	1 to 2	6
Fried Chicken	1 to 2	4
(Other than for meats and poultry)		
Most fruits and vegetables	8-12 months	
Lean fish	6-8 months	
Fatty fish, rolls and breads, soups, stew, casseroles	2-3 months	
Cakes, pies, sandwiches, left-overs (cooked), Ice cream (original carton)	1 month max.	

New techniques are constantly being developed. Consult the College or County Extension Service or your local Utility Company for the latest information on freezing and storing foods.

*U.S. Department of Agriculture

To store unfrozen meats, fish and poultry—Meats, fish and poultry purchased from the store vary in quality and age; consequently, safe storage time in your refrigerator will vary.

- Always remove store wrappings.
- Rewrap in foil, film or wax paper and refrigerate immediately.

To store cheese, wrap well with wax paper or aluminum foil, or put in a plastic bag.

- Carefully wrap to expel air and prevent mold.
- Store pre-packaged cheese in its own wrapping if you wish.

To store vegetables—Vegetable drawers have been specially designed to preserve natural moisture and freshness of produce.

- Crispness can be maintained by covering vegetables with a moist towel.
- As a further aid to freshness, pre-packaged vegetables can be stored in their original wrapping.

To store ice cream—Fine-quality ice cream, with high cream content, will normally require slightly lower temperatures than more "airy" already-packaged brands with low cream content.

• It will be necessary to experiment to determine the location in the freezer compartment and the temperature control setting to keep your favorite ice cream at the right serving temperature.

- Also, the rear of the freezer compartment is slightly colder than the front.

Tips on freezing foods

There are three essential requirements for efficient home freezing.

- 1. Initial quality.** Freeze only top-quality foods. Freezing retains quality and flavor; it cannot improve quality.
- 2. Speed.** The quicker fruits and vegetables are frozen after picking, the better the frozen product will be. You'll save time, too, because less culling and sorting will be necessary.
- 3. Proper packaging.** Use food wraps designed especially for freezing; they're readily available in a wide selection at your favorite store.

To freeze meat, fish and poultry, wrap well in freezer-weight foil (or other heavy-duty wrapping material) forming it carefully to the shape of the contents. This expels air. Fold and crimp ends of the package to provide a good, lasting seal.

Don't refreeze meat that has completely thawed; meat, whether raw or cooked, can be frozen successfully only once.

Limit freezing of fresh (unfrozen) meats or seafoods to number of pounds at a time as follows:
CTF17 16 pounds
CTF19 18 pounds

Organize your food storage for convenience.

- Store all like things together. This not only saves time, but electricity—because you can find foods faster.
- Place the oldest items up front so they can be used up promptly.
- Use the handy shelves on the door for most frequently used sauces and condiments.
- Use the meat drawer, if your model has one, for meats you do not freeze.

To save money in energy and food costs.

- Place most perishable items such as milk, cream or cottage cheese toward the rear of the top shelf as they will stay coldest in this part of the fresh food compartment.
- Cover moist foods with tight lids, plastic film or foil.
- Leaf vegetables and fruits placed in storage drawers will last longer when stored in closed plastic containers or wrapped in plastic film.
- Do not overload your fresh food or freezer compartment with a lot of warm food at once.
- Open the door the fewest times possible to save electrical energy.
- When going out of town for several days, leave as few perishables as possible in the refrigerator. If your refrigerator has an icemaker, move the icemaker manual switch to "OFF" and shut off water to the refrigerator.

Shelf Positions

Adjustable Shelves (on models so equipped)

Shelves on some models are adjustable, enabling you to rearrange them to fit your family's food storage needs.

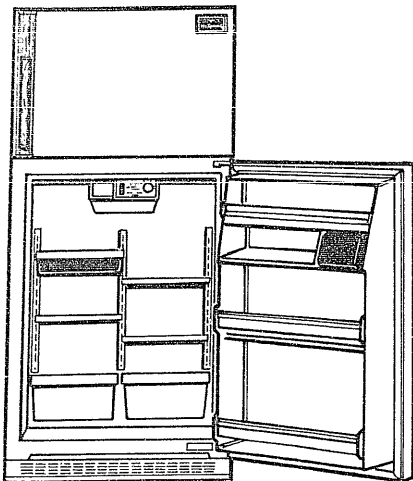

The typical shelf arrangement shown above is merely a guide—your individual requirements may call for more or less room between shelves or a different shelf arrangement.

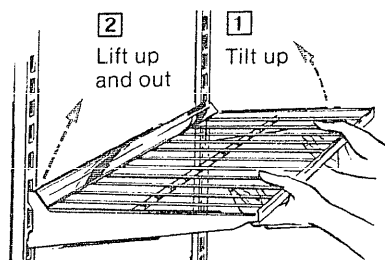

To remove shelves: Tilt shelf up at front, then lift it up and out of tracks on rear wall of refrigerator.

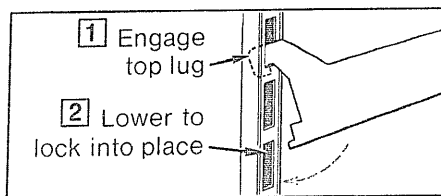

To replace shelves: Select desired shelf height. With shelf front raised slightly, engage top lugs in tracks at rear of cabinet. Then lower front shelf until it locks into position.

Tempered glass shelves (on models so equipped) are adjustable in the same manner.

Storage Drawers

Fruit and Vegetable Drawers (on models so equipped)

Drawers at bottom of fresh food compartment will stop before coming all the way out of refrigerator to help prevent contents from spilling onto floor. Drawers can easily be removed by tilting up slightly and pulling past "stop" location.

To remove drawers when the fresh food compartment door cannot be opened fully:

1. Remove drawer farthest from door.

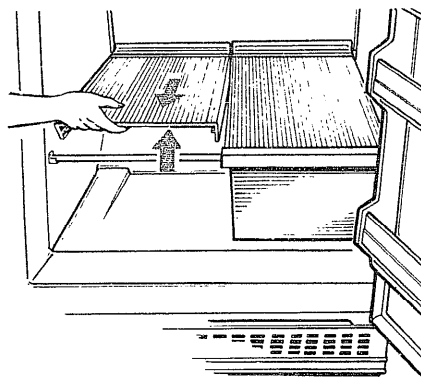

2. Lift drawer cover up and pull it out.

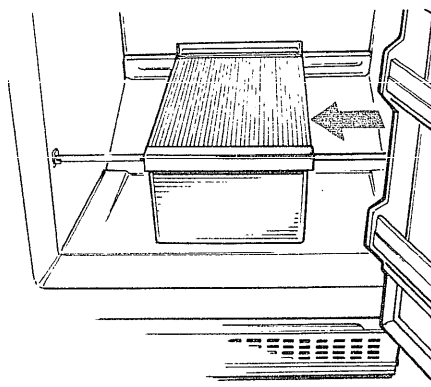

3. Slide remaining drawer and cover to the middle.

4. Remove drawer; then lift cover and remove it.

After cleaning, replace in reverse order.

Detachable Meat Drawer (on models so equipped)

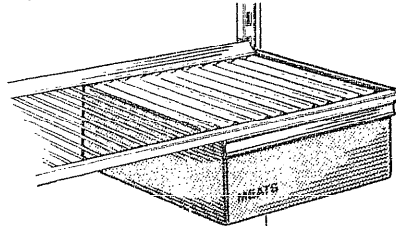

The slide-out meat drawer can be removed and taken to the sink or food preparation area.

On half-width shelf models, drawer and shelf to which it attaches can be relocated at any level.

On full-width shelf models, just slide drawer out, remove drawer cover from shelf above, relocate cover in the position you desire it and slide drawer back into place.

Ice Service

Easy Release™ Ice Trays (on models so equipped)

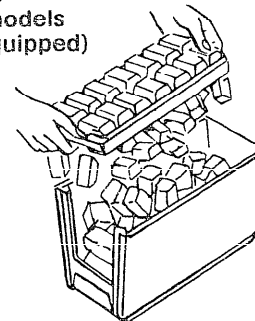

To release ice cubes, invert tray, hold it over storage bucket (on models so equipped) or bowl, and twist tray at both ends.

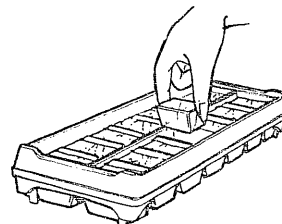

For only one or two ice cubes, leave the tray right-side up, twist both ends slightly and remove desired number of cubes.

Wash trays and storage bucket in lukewarm water only. Do not put them in an automatic dishwasher.

User Maintenance Instructions

Cleaning your refrigerator

Outside

Protect the paint finish. The finish on the outside of the refrigerator is a high quality, baked-on paint finish. With proper care, it will stay new-looking and rust-free for years. Apply a coat of appliance polish wax when the refrigerator is new and then at least twice a year.

Appliance Polish Wax & Cleaner (Cat. No. WR97X216) is available from GE/Hotpoint Appliance Parts Marts.

Keep the finish clean. Wipe with a clean cloth lightly dampened with appliance polish wax or mild liquid dishwashing detergent. Dry and polish with a clean, soft cloth. **Do not** wipe the refrigerator with a soiled dishwashing cloth or wet towel. **Do not use** scouring pads, powdered cleaners, bleach, or cleaners containing bleach.

Inside

Clean both fresh food and freezer compartments at least once a year. It is recommended that the refrigerator be unplugged before cleaning. If this is not practical, wring excess moisture out of sponge or cloth when cleaning in the vicinity of switches, lights or controls.

Use warm water and baking soda solution—about a tablespoon of baking soda to a quart of water. Rinse thoroughly with water and wipe dry. Follow this same procedure for cleaning door gaskets, meat and vegetable drawers, and all plastic parts. Wash ice trays and ice storage bin in lukewarm water only. **Do not** use cleansing powders or other abrasive cleaners.

Do not wash any plastic parts from your refrigerator in your automatic dishwasher.

Behind

Care should be taken in moving your refrigerator away from the wall. All types of floor coverings can be damaged, particularly cushioned coverings and those with embossed surfaces. If your refrigerator is on wheels, pull it straight out and return it to position by pushing it straight in. Moving your refrigerator in a side direction may result in damage to your floor covering or refrigerator.

Condenser

For most efficient operation, remove the base grille (see page 2) and remove the defrost water pan, then either sweep away or vacuum up dust that is readily accessible. This easy cleaning operation should be done at least once a year.



Defrost Water Pan

Pan located behind base grille should be cleaned at least once a year. When reinstalling pan, firmly push pan **ALL THE WAY IN** until it stops.

Accessories

Automatic Icemaker Accessory Kit (optional at extra cost)

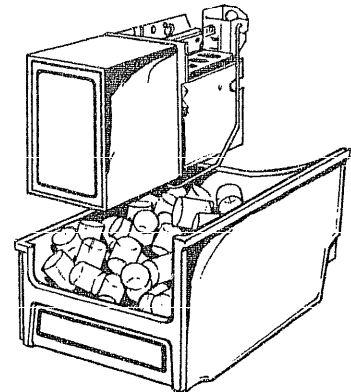

A Hotpoint automatic icemaker will replace the ice you use... automatically. It can keep you supplied with a binful of cubes—ice for everything, everybody—without fuss or muss.

If your refrigerator did not come already equipped with an automatic icemaker, you may add one—contact your local Hotpoint dealer; specify UK-KIT-1.

Note: Some models are not equipped to accept an automatic icemaker.

The perfect companion to your automatic icemaker— Quadra Kleen Water Filter

Your ice cubes can only be as clear and fresh-tasting as the water that produces them. That's why it's a good idea to purify your water with a Quadra Kleen Water Filter.

Its activated charcoal removes musty, stale odors and unpleasant medicinal, metallic tastes. A porous fiber cartridge catches dirt, rust particles, sand and silt while special crystals reduce deposits of hard scale.

The water filter is an option at extra cost and is available from your Hotpoint dealer. Specify WR97X214. It has complete installation instructions and installs in minutes on 1/4" O.D. copper water line.

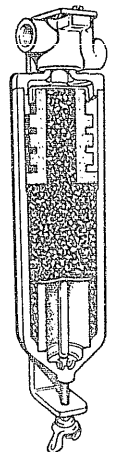

The Problem Solver

- If you have a problem, it may be minor. You may be able to correct it yourself. Just use this Problem Solver to locate your problem and then follow the suggested recommendations.

Save time and money...before you call for service, check the following:

PROBLEM	POSSIBLE CAUSE AND REMEDY
REFRIGERATOR DOES NOT OPERATE	<ul style="list-style-type: none"> ● May be in defrost cycle when motor does not operate for about 30 minutes. ● Temperature control in OFF position. ● If interior light is not on, refrigerator may not be plugged in at wall receptacle. ● If plug is secure and the refrigerator still fails to operate, plug a lamp or a small appliance into the same outlet to determine if there is a tripped circuit breaker or burned out fuse.
MOTOR OPERATES FOR LONG PERIODS	<ul style="list-style-type: none"> ● Modern refrigerators with more storage space and a larger freezer compartment require more operating time. ● Normal when refrigerator is first delivered to your home—usually requires 24 hours to completely cool down. ● Large amounts of food placed in refrigerator to be cooled or frozen. ● Hot weather—frequent door openings. ● Door left open. ● Temperature controls are set too cold. Refer to page 3. ● Grille and condenser need cleaning. Refer to page 6. ● Check ENERGY SAVING TIPS on inside front cover.
MOTOR STARTS & STOPS FREQUENTLY	<ul style="list-style-type: none"> ● Temperature control starts and stops motor to maintain even temperatures.
VIBRATION OR RATTLING	<ul style="list-style-type: none"> ● If refrigerator vibrates, more than likely it is not resting solidly on the floor and front roller screws or leveling legs need adjusting or floor is weak or uneven. Refer to INSTALLATION on page 2. ● If dishes vibrate on shelves, try moving them. Slight vibration is normal. ● Defrost water pan rattling, needs to be positioned properly.
OPERATING SOUNDS	<ul style="list-style-type: none"> ● The high speed compressor motor required to maintain near zero temperatures in the large freezer compartment may produce higher sound levels than your old refrigerator. ● Normal fan air flow—one fan blows cold air through the refrigerator and freezer compartments—another fan cools the compressor motor. ● These NORMAL sounds will also be heard from time to time: <ul style="list-style-type: none"> ○ Defrost timer switch clicks at defrost. ○ Defrost water dripping into drain pan. ○ Temperature control clicks ON or OFF. ○ Refrigerant boiling or gurgling. ○ Cracking or popping of cooling coils caused by expansion and contraction during defrost and refrigeration following defrost. ○ With automatic icemaker, the sound of cubes dropping into the bin and water running in pipes as icemaker refills.
HOT AIR FROM BOTTOM OF REFRIGERATOR	<ul style="list-style-type: none"> ○ Normal air flow cooling motor. <i>In the refrigeration process, it is normal that heat be expelled in the area under the refrigerator. Some floor coverings will discolor at these normal and safe operating temperatures. Your floor covering supplier should be consulted if you object to this discoloration.</i>

(continued next page)

PROBLEM	POSSIBLE CAUSE AND REMEDY
FRESH FOOD COMPARTMENT TEMPERATURE TOO WARM	<ul style="list-style-type: none"> • Temperature control not set cold enough. Refer to page 3. • Warm weather—frequent door openings • Door left open for long time. • Package may be holding door open. • Package blocking air duct in freezer compartment.
FOODS DRY OUT	<ul style="list-style-type: none"> • Foods not covered, wrapped or sealed properly.
FROST OR ICE CRYSTALS ON FROZEN FOOD	<ul style="list-style-type: none"> • Door may have been left ajar or package holding door open. • Too frequent and too long door openings. • Frost within package is normal.
SLOW ICE CUBE FREEZING	<ul style="list-style-type: none"> • Door may have been left ajar. • Turn temperature of freezer compartment colder.
ICE CUBES HAVE ODOR/TASTE	<ul style="list-style-type: none"> • Old cubes need to be discarded. • Ice storage bin needs to be emptied and washed. • Unsealed packages in refrigerator and/or freezer compartments may be transmitting odor/taste to ice cubes. • Interior of refrigerator needs cleaning—refer to page 6.
MOISTURE FORMS ON OUTSIDE OF REFRIGERATOR	<ul style="list-style-type: none"> • Not unusual during period of high humidity. • Move the energy saver switch to the right. 
MOISTURE COLLECTS INSIDE	<ul style="list-style-type: none"> • Too frequent and too long door openings. • In humid weather air carries moisture into refrigerator when doors are opened.
WATER ON FLOOR	<ul style="list-style-type: none"> • Defrost water pan full, missing or not in position.
REFRIGERATOR HAS ODOR	<ul style="list-style-type: none"> • Foods with strong odors should be tightly covered. • Check for spoiled food. • Interior needs cleaning. Refer to page 6. • Defrost water pan needs cleaning. • Keep open box of baking soda in refrigerator; replace monthly.

Rapid Electrical Diagnosis

Your refrigerator is wired for accurate electrical diagnosis in your home—takes only minutes for a service technician to check its entire electrical system. No need to unplug, move or unload refrigerator to make diagnosis.

When you go on vacation

For extended vacations or absences, shut off power to refrigerator, turn the numbered control OFF, clean interior with baking soda solution of one table-spoon of soda to one quart of water. Wipe dry. To prevent odors, leave open box of soda in refrigerator. Leave doors open.

For shorter vacations, remove perishable foods and leave controls at regular settings. However, if room temperature is expected to drop

below 60°F. follow same instructions as for extended vacations.

If you have an icemaker, move icemaker manual switch to OFF position and be sure to shut off water supply. ON-OFF switch is located near the front of the icemaker.

When you move

Disconnect power cord from wall receptacle, remove all food and clean and dry the interior.

Secure all loose items such as grille, shelves, and storage pans by taping them securely in place to prevent damage.

Be sure refrigerator stays in *upright position only* during actual moving and in van. Refrigerator must be secured in van to prevent movement. Protect outside of refrigerator with blanket.

How to do away with surprise repair bills

Your new appliance is a well designed and engineered product. Before it left the factory, it went through rigorous tests, just to make sure it was as defect-free as possible. And you have a warranty to protect you against any manufacturing defects during the early period of your appliance's life.

Now you can have the same trouble-free and surprise-free service for as long as you own your appliance. You can buy a Hotpoint Service Contract. For one low fee... usually just pennies a day... Hotpoint will take care of any repairs your appliance needs—both parts and labor. You are protected for the length of your contract. Even when costs go up, you pay nothing more.

Want more information? There's no obligation. You can get information on Service Contracts any time. Just write your name and address, date of installation, and the model and serial number of your appliance and send to:

Manager, Service Contracts
Hotpoint
WCE-315
Appliance Park
Louisville, KY 40225

Hotpoint helps the do-it-yourselfer

If you're the kind of person who likes to do-it-yourself—or if you're interested in saving money on out-of-warranty repairs—Hotpoint now offers some real help:

Step-by-Step Repair Manual

You can use this manual to solve common repair problems. Hotpoint makes it easy because your manual contains important do-it-yourself information:

- charts to help you diagnose problems
- easy to understand instructions
- step-by-step photos with repair procedures
- a skill level index
- the recommended tools needed to perform repairs

Replacement Parts

When repairing your appliance, be sure to use authorized Hotpoint replacement parts. Each part is packaged in a color coded box with:

- easy parts identification
- estimated time of repairs
- step-by-step instructions
- recommended tools

Where to Purchase Step-by-Step Repair Manuals and Parts

You can purchase Hotpoint repair manuals and replacement parts for your appliance from authorized participating Hotpoint dealers.

Note: Of course, repairs should be attempted only by individuals possessing adequate backgrounds of electrical, electronic and mechanical experience. Any attempt to repair a major appliance may result in personal injury and property damage.

If you need service

In many cities, there's a Hotpoint Factory Service Center. Call, and a radio-dispatched truck will come to your home by appointment—morning or afternoon. Charge the work, if you like. All the centers accept both MasterCard and Visa Cards. Check the White Pages for "HOTPOINT FACTORY SERVICE."

Or look for Hotpoint franchised Customer Care® servicers. You'll find them in the Yellow Pages under "HOTPOINT CUSTOMER CARE® SERVICE" or "GENERAL ELECTRIC—HOTPOINT CUSTOMER CARE® SERVICE."

If you need service literature, parts lists, parts or accessories, contact one of the Factory Service

Centers, a franchised Customer Care® servicer or your dealer.

If you are dissatisfied with the service you received, here are three steps you should follow:

FIRST, contact the people who serviced your appliance. Explain why you are dissatisfied. In most cases this will solve the problem.

NEXT, if you are still dissatisfied, write all the details—including your phone number—to:

Manager, Consumer Relations
Hotpoint
WCE-312
Appliance Park
Louisville, KY 40225

FINALLY, if your problem is still not resolved, write:

Major Appliance Consumer
Action Panel
20 North Wacker Drive
Chicago, IL 60606

This panel, known as MACAP, is a group of independent consumer experts under the sponsorship of several industry associations. Its purpose is to study practices and advise the industry of ways to improve customer service. Because MACAP is free of industry control and influence, it is able to make impartial recommendations, considering each case individually.

YOUR HOTPOINT REFRIGERATOR WARRANTY

Save proof of original purchase date such as your sales slip or cancelled check to establish warranty period.

WHAT IS COVERED

FULL ONE-YEAR WARRANTY

For one year from date of original purchase, we will provide, free of charge, parts and service labor in your home to repair or replace *any part of the refrigerator* that fails because of a manufacturing defect.

FULL FIVE-YEAR WARRANTY

For five years from date of original purchase, we will provide, free of charge, parts and service labor in your home to repair or replace *any part of the sealed refrigerating system* (the compressor, condenser, evaporator and all connecting tubing) that fails because of a manufacturing defect.

This warranty is extended to the original purchaser and any succeeding owner for products purchased for ordinary home use in the 48 mainland states, Hawaii and Washington, D.C. In Alaska the warranty is the same except that it is LIMITED because you must pay to ship the product to the service shop or for the service technician's travel costs to your home.

All warranty service will be provided by our Factory Service Centers or by our franchised Customer Care® servicers during normal working hours. Check the White Pages for HOTPOINT FACTORY SERVICE. Look in the Yellow Pages for HOTPOINT CUSTOMER CARE® SERVICE or GENERAL ELECTRIC-HOTPOINT CUSTOMER CARE® SERVICE.

WHAT IS NOT COVERED

- Service trips to your home to teach you how to use the product.

Read your Use and Care Material. If you then have any questions about operating the product, please contact your dealer or our Consumer Affairs office at the address below or call, toll-free:

The GE Answer Center™
800.626.2000
consumer information service.

- Improper installation.

If you have an installation problem, contact your dealer or installer. You are responsible for providing adequate electrical, plumbing and other connecting facilities.

- Replacement of house fuses or resetting of circuit breakers.

- Failure of the product if it is used for other than its intended purpose or used commercially.

- Damage to product caused by accident, fire, floods or acts of God.

WARRANTOR IS NOT RESPONSIBLE FOR CONSEQUENTIAL DAMAGES.

Some states do not allow the exclusion or limitation of incidental or consequential damages, so the above limitation or exclusion may not apply to you. This warranty gives you specific legal rights, and you may also have other rights which vary from state to state. To know what your legal rights are in your state, consult your local or state consumer affairs office or your state's Attorney General.

Warrantor: General Electric Company

If further help is needed concerning this warranty, contact:

Manager—Consumer Affairs, General Electric Company, Appliance Park, Louisville, KY 40225

Part No. 467726P04
Pub. No. 39-6193

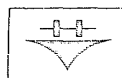

Hotpoint
A QUALITY PRODUCT OF GENERAL ELECTRIC COMPANY



Free Manuals Download Website

<http://myh66.com>

<http://usermanuals.us>

<http://www.somanuals.com>

<http://www.4manuals.cc>

<http://www.manual-lib.com>

<http://www.404manual.com>

<http://www.luxmanual.com>

<http://aubethermostatmanual.com>

Golf course search by state

<http://golfingnear.com>

Email search by domain

<http://emailbydomain.com>

Auto manuals search

<http://auto.somanuals.com>

TV manuals search

<http://tv.somanuals.com>